



Class

Book





RAILWAY ENGINEERING SOCIETY

Railway Mechanical Engineer

Two Sections—Section No. 2

December, 1917

Established 1832

90.32

INDEX TO VOLUME XCI

1917

INDEX, 1917

VOLUME XCI

A

Abrasive belt finishing machine, Blevney Machine Co.	652*
Acar Mfg. Co., Blue signal safety device	410*
Aeroplane, Express packages by	644*
Aeroplane flights, Record-breaking	706*
Air and signal hose couplings, Emergency	688*
Air Brake (see also Brake, Air)	
Air Brake Association convention	385, 389
Air brakes, Appliances for testing freight car, in yards, by M. K.	148*
Air brakes on freight cars, Maintenance of, by H. S. Walton	145
Air commerce after the war	497*
Air compressor stuffing boxes, Reclaiming, by C. W. Schane	212*
Air compressors in yards	368*
Air compressors, Lubrication of	704
Air hose connection for pits, by R. L. Preston	268*
Air pump air strainer, Gustin-Bacon Mfg. Co.	48*
Air pump capacity, Method of increasing, on double headed trains, by E. F. Given	435*
Air pump cylinders, Jig for reboring compound, by E. F. Glass	458*
Air pump inlet and discharge valves, Gages for determining the lift of, by H. S. Waldron	322*
Air pump main valve bushings, Boring bar for	510*
Air pump packing gland rings, Reclaiming, by W. K. Cleary	398*
Air pump pistons, Removing, by J. A. Jesson	510*
Air pump strainer, Canadian Northern	132*
Air pump strainer, N. T. Cline	515*
Air pumps, Lubricating air cylinders of cross-compound, by J. H. Hahn	648*
Air strainer, Westinghouse "Fifty-four" Westinghouse Air Brake Co.	272*
Ajax Mfg. Co., New forging machine	462*
Alignment of locomotive parts, Proper (Gen'l Foremen's Assoc.)	502*
American Flexible Staybolt Co., Flexible staybolt	353*
American Society of Mechanical Engineers	663*
American Steam Gage & Valve Mfg. Co., Trainagraph	650*
American Steel Foundries, Brake beam safety hanger	162*
American Steel Foundries, Simplex clasp brake	506*
American Tool Works Co., Triple purpose radial drill	271*
Anderson, W. S., Tools for turning and threading small screws	211*
Angle cock grinding machine, A. T. & S. F.	696*
Annealing steel, Reasons for	40*
Anthony, J. T., Prevention of locomotive smoke	621*
Apprentice course, Suggestions for a car department, by J. H. Douglas (Car Foremen's Assoc.)	136
Apprentice instructors' meeting, Santa Fe	505*
Apprentice methods, Boiler shop, Santa Fe	585
Apprentice, The car department, by Frank Deyot, Jr. (Car Foremen's Assoc.)	253
Apprentices, Car department, by E. Carr	84
Apprentices of the Santa Fe, Freight car	572*
Apprentices, Why not have car department? by George A. Marlow (Car Foremen's Assoc.)	198
Apron for heavy duty lathe, Houston, Standwood & Gamble Co.	461*
Arc Welding (see Welding)	
Arc Welding Machine Co., Constant current, closed circuit arc welding system	161*
Arch, Brick, Prevention of locomotive smoke	621*
Arch tests, Locomotive brick	228*
Arch tests, Locomotive brick, Pennsylvania Railroad	235*
Arch tube cleaner, The details of an, Lagonda Mfg. Co.	109*
Armstrong Bros. Tool Co., Tool holders	352*
Armstrong, George, Centralized production of locomotive repair parts	289*
Armstrong, George, Standardization and improvement in locomotive service	541
Ash pan, Cast steel, Commonwealth Steel Co. Association of Railway Electrical Engineers (see Railway Electrical Engineers' Association)	599*

Association year books, Mechanical	421*
Atchison, Topeka & Santa Fe, Angle cock grinding machine	696*
Atchison, Topeka & Santa Fe, Apprentice instructors' meeting	505*
Atchison, Topeka & Santa Fe, Boiler shop apprentice methods	585
Atchison, Topeka & Santa Fe, Double deck stock cars	337*
Atchison, Topeka & Santa Fe, Freight car apprentices	577*
Atchison, Topeka & Santa Fe, Pulverized coal plant for the	187*
Atchison, Topeka & Santa Fe, Reducing breaks-in-two on the	341
Atchison, Topeka & Santa Fe, Tank car	580*
Attachment, Relieving, for engine lathes, Cincinnati Iron & Steel Co.	348*
Automatic Straight Air Brake Co., Passenger and freight brake	632*
Axe generator location on passenger cars	474*
Axles, Jig for upsetting	463*
Axles, Machining car wheels and	453
Axles, Recentering car, by E. A. M.	256*

B

Babbitting valve rod crossheads, by J. A. Jesson	262*
Baltimore & Ohio, Instructions in good firing	334
Baltimore & Ohio, Refrigerator car	685*
Barnes Drill Co., All-gearred drill and tapper	351*
Barnum, E. S., Convention attendance competition article	68
Barnum, M. K., Conservation of railway material	670
Barth, Carl G., Lathe centers and drill press and milling-machine sockets (A. S. M. E.)	43*
Bartz, A. L., Hot box competition article	136
Basenberg, W. H., Journal polisher	708*
Belnap, Hiram W., Car inspection of vital importance	79
Belnap, Hiram W., Safety appliance standards	393*
Bentley, F. W., Jr., Emergency injector repair	407*
Bentley, F. W., Jr., Emergency repairs to straight air brake valve	268*
Bentley, F. W., Jr., Locating defective safety valves	267*
Bentley, H. T., Locomotive terminal delays	639*
Betcher, W. H., Importance of proper loading of cars (Gen'l Foremen's Assoc.)	341
Bills of material, (Gen'l Foremen's Assoc.)	173*
Blacksmiths' Assoc., Powdered coal for blacksmith shops	123
Blevney Machine Co., Abrasive belt finishing machine	652*
Blue signal safety device, Acar Mfg. Co.	410*
Bohannon, W. J., Saving metal in valve bushings	400*
Boiler capacity of locomotives, Utilizing the boiler feed water, A study of, by George L. Fowler	530*
Boiler feed water treatment, A convenient method of, Paige & Jones Chemical Co.	127*
Boiler metal treatment, A, Perolin Railway Service Co.	271
Boiler patches for locomotives, by M. J. Cairns	259*
Boiler scaler, Valveless, George Oldham & Son Co.	354*
Boiler sheet stock, Rack for storing, by C. L. Dickert	314*
Boiler sheets, Flanging, cold, by E. P. Fairchild	36*
Boiler tests, Firebox temperature	550*
Boiler tube testing machine, Watson-Stillman Co.	214*
Boiler tube reclaiming machine, Joseph T. Ryerson & Son	162*
Boiler tubes, Applying locomotive, by R. B. Carr	149
Boiler tubes, Renewing, by Daniel Cleary	209
Boiler tubes (see also Tubes)	
Boilers, Annual report of the chief inspector of locomotive	9
Boilers, Effect of soot in	109*
Booster, Hutton truck, Joliet Ry. Supply Co.	601*
Bolt clamp, Pneumatic, by Howard W. Stull	35*
Bolt cutter, Turning bolts in a, by Arthur J. Humphrey	93*
Bolt machine, Flat punch for Ajax, by C. W. Schane	459*

Books

Air Brake Association proceedings, edited by F. M. Nellis	533
Carnegie shape book, Carnegie Steel Co.	666
Combustion in the fuel bed of hand-fired furnaces, by Henry Kreisinger et al.	288
Compressed air for the metal worker, by Chas. A. Hirschberg	666
Effects of storage on properties of coal, by S. W. Parr	611
First aid instructions for miners, U. S. Bureau of Mines	533
First principles of electricity, by J. E. Homans	4
Founders' manual, The, by David W. Payne	476
Fuel Association proceedings	175
Locomotive handbook, compiled by American Locomotive Co.	611
Locomotive valves and valve gears, by Jacob H. Yoder and Geo. B. Wharen	612
Official proceedings of the American Railway Tool Foremen's Association	119
Oxyacetylene welding and cutting, by P. F. Willis	230
Preliminary mathematics, by Prof. F. E. Austin	175
Proceedings of the International Railway General Foremen's Association	119
Proceedings of the Master Car and Locomotive Painters' Association	63
Proceedings of the Traveling Engineers' Association	230
Proceedings of the twenty-fourth annual convention of the International Railroad Master Blacksmiths' Association	119
Steel and its heat treatment, by Denison K. Bullens	288
Turret lathe guide, Gisholt Machine Co.	288
Borer, F. J., Pneumatic punching machine	695*
Borer, Novel use for car wheel	264*
Boring bar for use on cylinders and valve chambers at the same time by A. C. Hinckley	503*
Boring bar for Westinghouse main valve bushings, by J. H. Hahn	510*
Boring bar (see also Machine tools)	
Boring equalizer brackets in place, C. & N. W.	649*
Boring machine (see Machine tools)	
Boring, milling and drilling machine (see Machine tools)	
Boston & Albany, Conversion of Consolidation type locomotives to 8-wheel switchers	488*
Boston & Maine, Reclaiming air pump packing gland rings	398*
Bradney Machine Co., Inc., Jacks with non-revolving screws	709*
Brake, Air, Association convention report	342*
Brake, Automatic straight air	633*
Brake beam safety hanger, American Steel Foundries	162*
Brake cylinder packing leathers, Cleaning and lubricating, by R. C. Burns (Air Brake Assoc.)	344*
Brake cylinder pressure regulator	438
Brake hose, air, Safe life of (Air Brake Assoc.)	443
Brake leakage determinations, Train, by C. R. Weaver	629*
Brake lever computations, Air, by Lewis K. Silcox	245*
Brake Rigging, Passenger car foundation, by Walter V. Turner	199*
Brake rigging, Safety hanger for, Elgin, Joliet & Eastern	448*
Brake, Simplex clasp, Am. Steel Fdries	596*
Brake slack adjuster, Truck lever type for freight cars, Gould Coupler Co.	600*
Brake system, Air, Functional interrelation between the component parts of the, by W. E. Dean (Air Brake Assoc.)	342*
Brake valve, Air, Emergency repairs to straight, by F. W. Bentley, Jr.	268*
Brake-air, Improvement in, on freight cars, by J. S. Breyer	476*
Brasses, Chuck for shaping main rod, C. B. & Q.	696*
Brazil, Use of pulverized coal in	617*
Breaks-in-two on the Santa Fe, Reducing	341
Breyer, J. S., Improvement in air brakes on freight cars	476*

Book—(Continued)

Breuer, J. S., Prize article, Hot box competition 21
 Brown & Sharpe Mfg. Co., Heavy service plant grinding machine 213*
 Brown & Sharpe Mfg. Co., Plain grinding machine 347*
 Brown & Sharpe Mfg. Co., Power fast traverse for milling machine tables 104*
 Brown & Sharpe Mfg. Co., Quick releasing face milling cutter 355*
 Brown, H. B., Kindling fires in locomotives (Fuel Association convention) 332*
 Brown, H. M., Second prize article, Rod job competition 391*
 Buckeye Steel Castings Co., 6 wheel truck for Virginian 120-ton coal car 309*
 Bucknell-Thomas Co., Thread lead indicator 463*
 Buffalo Forge Co., Portable motor driven shear 519*
 Buffalo, Rochester & Pittsburgh, Clear vision cob windows 649*
 Buffalo, Rochester & Pittsburgh, Saving effected by breaking scrap 237*
 Burns, R. C., Cleaning and lubricating brake cylinder packing leathers (Air Brake Assoc.) 344*
 Burns, T. J., The lubrication of freight cars in interchange 335
 Bushings, Air press for rod, and driving brasses 588*
 Bylund, Walter R., Hot box competition article 77*

C

Cab appointments, Location of 529§
 Cab windows, Clear vision, by J. H. Nagle 649*
 Cairns, M. J., Boiler patches for locomotives 259*
 Campbell, A., Making a car inspector 194
 Canada, Railway management, competition 558*
 Canadian Northern, Air pump strainer 133*
 Canadian Pacific, Hesse testing machine 514*
 Capacity, More motive power 664§

Car

Axles (see Axles).
 Department apprentice, The, by Frank Deyot, Jr. (Car Foremen's Assoc.) 253
 Department apprentice course, Suggestions for a, by J. H. Douglas (Car Foremen's Assoc.) 136
 Department apprentices, by W. K. Carr (3rd prize, car inspectors' competition) 84
 Department apprentices, Why not have? by George A. Marlow (Car Foremen's Assoc.) 198
 Department material, Handling, by R. A. Doherty 567
 Department organization and efficiency, by J. C. R. Dolson (Car Foremen's Assoc.) 24
 Design, Economics of, by J. A. Filcher 565*
 Dining, Water heater, Western Maryland Door, Box, side 252*
 Door lock, Automatic freight, Gustin-Bacon Mfg. Co. 108*
 Draft gear problem, The 1§
 Draft sills, Reinforcing freight, by Lewis K. Silcox 195*
 End framing, Stresses on, by H. J. Hennessy 582
 Inspection of vital importance, by Hiram W. Belpap 79
 Inspector, Making a, by A. Campbell 194
 Inspectors' duties, Piecework and, by W. H. Sitterly 628
 Inspectors need better training 63§
 Journal box (see Journal box).
 Keeping in service 285§
 Market 537*
 Orders in 1916 5*
 Passenger, Floors, Insulation for, Tuco Products Corporation 464*
 Passenger, foundation brake rigging, by Walter V. Turner 190*
 Postal, New floor plans for 637*
 Prices 430
 Repair forces, Co-operation between yard and, by R. H. Dyer (Car Foremen's convention) 255
 Repair problems, Freight, by Lewis K. Silcox 137*
 Repair situation, Freight 531§
 Repair yards, Arrangement of, 610§
 Repairs, Handling freight, by Lewis K. Silcox 569*
 Shop, Steel, E. J. & E. 563*
 Shortage, Car men and the 422§
 Shortage or congestion? 285§
 Step, Extension coach, D. M. & N. Truck (see Truck).
 Underframe reinforcement, unique, Marsh Refr. Service Co. 578*
 Ventilating shutter, Wine Railway Appliance Co. 45*
 War performance of 611§
 Wheel (see Wheel).
 Work, Passenger, by J. R. Schrader 77

Car Foremen's Association proceedings, 136, 255, 256
 Car Inspectors' and Car Foremen's Association convention 24, 77, 341

Cars

Box, French, built in America 439*
 Box, The Standard 3§
 Coal, 120-ton, Virginian Railway 493*
 Dining, with unique table arrangement, Erie Railroad 346*
 Freight, D. & H. steel underframe for wood 683*
 Furniture, Strengthening wooden 437*
 Gondola, Steel, versus composite, by William Queenan 253
 Heater, Tests of Moore 710
 Hopper, 85-ton, Pennsylvania 191*
 Hospital, Erie Railroad 637*
 Motor, Oil-electric, Electric Car & Locomotive Corp. 491*
 Narrow gage steel hopper, Burma, by F. C. Coleman 692*
 Narrow-gage, used behind the trenches in France 498*
 Passenger, Resistance of, by E. C. Schmidt and H. H. Dunn 247*
 Passenger, Location of axle generator on 474§
 Passenger, Steel, C. B. & O. 143*
 Passenger, Steel, for D. & H. 85*
 Passenger, Steel, Erie Railroad 387*
 Refrigerator, B. & O. 685*
 Refrigerator, Pennsylvania Railroad 133*
 Stock, Santa Fe double deck 337*
 Stock, Wood, Hiram Central 28
 Tabular comparison of Automobile 391*
 Tabular comparison of Box 26, 27
 Tabular comparison of Chair 31
 Tabular comparison of Coaches, Vestibule Steel 32, 33
 Tabular comparison of Dining 34
 Tabular comparison of Gondola and Hopper 29
 Tabular comparison of Refrigerator 25
 Tabular comparison of Stock 30
 Tank, Santa Fe 580*
 U. S. Gov't for France 537*
 Wooden freight 367§
 Wooden framed freight equipment, by M. D. 336
 Carbon monoxide, Killed by 218†
 Carl, W. K., 3rd prize article, car inspectors' competition 84
 Carty, F. J., Conversion of Consolidation type locomotives to 8-wheel switchers 488*
 Casehardening with cyanide, A furnace for, by E. T. Spidy 91*
 Catalogues 59, 116, 172, 226, 282, 420, 472, 528, 662
 Cement, Cast iron 316†
 Cement gun, The 407†
 Centering machine, by E. F. Glass 153*
 Central of Georgia, Handling rods at Macon shops 449*
 Central of Georgia, Rack for storing boiler sheet stock 314*
 Central Railroad of New Jersey, Pneumatic punching machine 695*
 Chancy, J. H., Aldinger power shears 460*
 Chancy, J. H., Eye forming machine 219*
 Chancy, J. H., Ladder riveting machine 162*
 Chancy, J. H., Radial link grinder 587*
 Change in fiscal year 18
 Chesapeake & Ohio, Forming knuckle pin nuts under the steam hammer 147*
 Chesapeake & Ohio, Pneumatic shearing machine 455*
 Chesapeake & Ohio, Rod work on the, by H. M. Brown 399*
 Chicago & Eastern Illinois, Converted switch locomotives 619*
 Chicago & Eastern Illinois, Making steam pipes by oxywelding 154*
 Chicago & North Western, Boring equalizer brackets in place 649*
 Chicago & North Western, Purifying shop drinking water 202*
 Chicago & North Western, Shield for tempering blast 695*
 Chicago & North Western, Steam hammer dies for superheater flues 640*
 Chicago, Burlington & Quincy, All steel passenger cars 143*
 Chicago, Burlington & Quincy, Chuck for shaping main rod brasses 696*
 Chicago Great Western, Steam pipe joint rings 9*
 Chicago, Rock Island & Pacific, An innovation in tender design 673*
 Chicago, Rock Island & Pacific, Cutting bores in side rods with oxy-acetylene 455*
 Chicago, Rock Island & Pacific, Electric welding on the, by E. Wamalers 307*
 Chicago, Rock Island & Pacific, Forging machine methods at Silvis shops 583*
 Chicago, Rock Island & Pacific fuel department 434*
 Chicago, Rock Island & Pacific, Reclaiming car material 627*
 Chicago, Rock Island & Pacific, Superheater unit tester 153*
 Chief Interchange Car Inspectors and Car Foremen's Association (see Car Inspectors' and Car Foremen's Association).
 Chiles, G. S., Design of heavy helical springs 477*
 Christy, George C., Hot box competition article 78
 Christy, George C., Rod job competition article 503*

Cincinnati Bickford Tool Co., Motor drive for radial drills 652*
 Cincinnati Iron & Steel Co., "Cisco" re-heating attachment 348*
 Cincinnati, New Orleans & Texas, Modern railway shop lighting 207*
 Cincinnati Planer Co., Planer 350*
 Clarke, R. K., 2nd prize article, convention attendance competition 67
 Clark, W. S., Hot box competition article 249
 "Cleaning up" Muncie roundhouse, by Harvey DeWitt Wolcomb 265
 Cleary, Daniel, Prolonging the life of fire-bricks 94
 Cleary, Daniel, Renewing boiler tubes 209
 Cleary, Daniel, Repairing cracks in the flanges of tube sheets 158
 Cleary, William K., Reclaiming air pump packing gland rings 398*
 Cleveland Twist Drill Co., Tool for removing broken studs 161*
 Clin, N. F., Air pump strainer 476†
 Coal, Cost of, on Swiss railways 464†
 Coal, Effect of labor troubles on production 688†
 Coal for blacksmith shops, powdered, by C. F. Herington (Blacksmiths' Assoc.) 123
 Coal, Increased production in France 688†
 Coal, Normal world production of 424†
 Coal plant, Pulverized, A. T. & S. F. 187*
 Coal, Use of pulverized, in Brazil 617*
 Coleman, F. C., Narrow gage steel hopper car 692*
 Collision, Mount Union 187*
 Collision shocks on steel equipment 173§
 Commonwealth Steel Co., Cast steel pilot and ash pan 599*
 Commonwealth Supply Co., Lewis power reverse gear 707*
 Competition, Association, Master Painters tell of benefits from convention attendance 201
 Competition, Convention attendance, articles 67, 155, 665§
 Competition, Enginehouse terminal 697
 Competition, Engine terminal, first prize article by O. T. Dickens 699*
 Competition, Engine terminal, second prize article, by T. S. Grant 709
 Competition, Engine terminal, third prize article, by K. R. Mitchell 2§
 Competition, Hot box, articles 21, 77, 197
 Competition, Hot box, article, by George C. Christy 78
 Competition, Hot box, article, by W. S. Clark 249
 Competition, Hot box, article, by Jos. Dalzell 246
 Competition, Hot box, article, by M. Glenn, Sr. 146
 Competition, Hot box, article, by C. S. Taylor 254
 Competition, Hot box, its cause and cure, by J. F. Luce 135
 Competition, Hot box, Three reasons for, by A. L. Bartz 106
 Competition, Locomotive terminal 510§
 Competition, Milling machine 117§
 Competition, Milling machine, announcement 61§
 Competition, Rod job 117§, 173§, 283§
 Competition, Rod job, prize article, by E. A. Miles 317*
 Competition, Rod job, second prize article, by H. M. Brown 399*
 Competition, Rod job, third prize article, by James Grant 405*
 Competition, Rod job, article by George C. Christy 503*
 Competition, Rod job, article by C. L. Diekert 449*
 Competition, Rod job, article by George Twist 513*
 Compressed air in railroad shops, The use of (Railway Electrical Engineers' convention) 39*
 Compressed air, The abuse of, by Lewis K. Silcox 531§
 Computed, Air brake lever, by Lewis K. Silcox 245*
 Conductor's relation to the oiler, The, by M. Glenn, Sr. (Hot box competition) 146
 Connector, Automatic train pipe, Union Automatic Connector Corp. 105*
 Convention attendance a big asset (competition articles) 67
 Convention attendance, Benefits from 18
 Conventions postponed, Mechanical 227§
 Conversion of Consolidation to 8-wheel switcher, by F. J. Carty 488*
 Coons, Charles N., Vaporizer for burning kerosene 263*
 Co-operation between yard and car repair forces, by R. H. Dyer (Car Foremen's Assoc.) 255
 Cepp, C. E., Association competition article 201
 Cost of equipment failures, The 62§
 Cost, Increasing output and reducing unit, by E. T. Spidy 315*
 Counterbalance of locomotives, Cross, by C. H. Paris 561*
 Couplings, Emergency air and signal hose 688*
 Cox, M. F., Repairing main and side rods 457*
 Crank pin inspection gage, Jerome-Edwards Metallic Packing Co. 413*

*Illustrated article; †editorial; ‡short non-illustrated article or note; §communication.

rule

- Crank pin press, Portable, Watson-Stillman Co. 650*
- Crawford, C. H., Power tests of machine tools 294*
- Crosshead keyway cutter, Portable piston rod and, Emmett G., Detrick 273*
- Crosshead pins, Dies for repairing threads on Crosshead shoes, Fastening, Charles Markel, Crosshead shoes, Die for planing outside of, by Locke Walker 648*
- Crossheads, Babbutting valve rod, by J. A. Jesson 262*
- Cutting-off machine (see Machine tools).
- D**
- Dalzell, Joseph Hot box competition article, Dean, W. E., Functional inter-relation between the component parts of the air brake system (Air Brake Assoc.) 342*
- Delaware & Hudson, Interesting back shop performance 401*
- Delaware & Hudson, Steel passenger cars, Delaware & Hudson steel underframe for wood freight cars 683*
- Denver & Rio Grande, Santa Fe type locomotives 431*
- Deficiencies due to defective equipment, by William Queenan 251
- Design, An innovation in tender 673*
- Design, Economics of car, by J. A. Pilcher 565*
- Design, Locomotive, from a maintenance standpoint 678
- Design, New departure in locomotive 369*
- Design of electric locomotives, Mechanical (A. S. M. E.) 75
- Design of forging machine dies, by E. R. Frost 645*
- Design of heavy helical springs, by G. S. Chiles and R. G. Kelley 47*
- Design, Preliminary locomotive, by W. R. Maurer 551*
- Design, Walschaert valve gear, by H. A. De Saussure, F. G., Some arc welding information 95*
- Detection records, Locomotive terminal, Penn. R. R. 625*
- Detrick, Emmett G., Portable piston rod and crosshead keyway cutter 273*
- Deyot, Jr., Frank, The car department apprentice (Car Foremen's Assoc.) 253
- Dickens, O. T., Engine terminal competition, first prize article 697
- Dickert, C. L., Convention attendance competition article 155
- Dickert, C. L., Rack for storing boiler sheet stock 314*
- Dies, H. L., Rod job competition article, Die for forming knuckle pin nuts under the steam hammer, by H. C. Gillespie 147*
- Die for forming strainer brasses 212*
- Die and holder, Acorn, Greenfield Tap & Die Corp. 590*
- Dies, Steam hammer, for superheater bushings, design of forging machine, by E. R. Frost 645*
- Distributing valves, Device for reboring, by E. S. Reardon 98*
- Dobson, C. R., Car department organization and efficiency (Car Foremen's Assoc.) 24
- Dodds, Ethan L., Cold stored light 515*
- Doherty, R. G., Handling material for the car department 567
- Donnell, J. F., A dining car water heater, Door, Box car side 252*
- Doud, Willard, Selection of machine tools 292
- Douglas, I. H., Suggestions for a car department apprentice course (Car Foremen's Assoc.) 136
- Dow, A. M., Prize article, Hot box competition 21
- Draft arm of rolled steel, Elgin, Joliet & Eastern Railway Equipment Co. 411*
- Draft gear attachment, Murray, Keyoke Railway Equipment Co. 411*
- Draft gear problem, The 18
- Draft gear requirements, Modern, by L. E. Walsley 689*
- Draft sills, Reinforcing freight car, by Lewis K. Silcox 195*
- Drafting of locomotives, Fuel economy and proper, by D. R. MacBain 130*
- Draper Mfg. Co., Flue reclaiming attachment Drawbar upsetting machine, A rod and, Walter Stock 463*
- Drawbars, Die for upsetting 463*
- Drill, Forged twist, A. E. Russ Forged Drill Co. 518*
- Drill press and milling machine sockets, Lathe centers and, by Carl G. Barth (A. S. M. E.) 43*
- Drill (see also Machine tools).
- Driving box collar bolt holes, Reducing wear in, by H. C. Spicer 258*
- Driving box chuck, Universal, M., St. P. and S. M. Co. 647*
- Driving box hub liner, A removable, by J. T. Millard 598*
- Driving box spring seat milling machine, by F. W. Secler 397*
- Driving box wedges with broken flanges, Reclaiming, by William Hall 39*
- Driving boxes, boring and facing with car wheel borer 264*
- Driving boxes, Hooks for lifting 209*
- Duluth, Missabe & Northern, Extension coach step 163*
- Dunn, H. H., Resistance of passenger cars, Dyer, R. H., Co-operation between yard and car repair forces (Car Foremen's Assoc.) 255
- E**
- Earnings, Freight car repair track 618
- Eccentric and side rods, Reversible Eccentrics, Rollers for applying, (G. Nor.) 706*
- Economics of the shop power house, by V. T. Kropidowski 243, 373*
- Economy Devices Corporation, Articulated tender trucks 216*
- Economy Devices Corporation, Type "B" Ragonnet reverse gear 597*
- Edmonds, G. S., The work of the men at home 606*
- Educate the trainmen, by A. W. Norton 666*
- Efficiency, Car department organization and, by C. R. Dobson (Car Foremen's Assoc.) 24
- Efficiency engineer, The, by Gulf 92
- Efficiency, Improve railroad 502*
- Efficiency, Increasing freight car 174*
- Efficiency, Railway, and the war, by Daniel Willard 489
- Efficiency, Shop, and illumination 610*
- Elgin, Joliet & Eastern, Draft arm of rolled steel 442*
- Elgin, Joliet & Eastern, Safety hanger for brake rising arms 448*
- Elgin, Joliet & Eastern, Steel car shops 563*
- Electric Car & Locomotive Corporation, Oil-electric motor car 491*
- Electric Controller & Manufacturing Co., Automatic starter for induction motors 653*
- Electric locomotive operation 186
- Electric welding 203*
- Electrical equipment repair shops 203*
- Emstley, L. E., Draft gear requirements 689*
- Engine failure, What is an? by A. B. C. 230*
- Engine failure, What is an? by W. J. 120*
- Engine failures, Analyze your 618
- Engine terminal competition 530*, 608*
- Engine terminal delay, Decreasing competition prize article 697*
- Engine terminal delays, by H. T. Bentley 639*
- Engine terminal delay records, Penn. R. R. 625*
- Engineers, The Ninth Regiment of 376*
- Engineers now in France, Railway 543*
- Engineers, Railway regiments tobacco fund, Engineers, 19th regiment, Word from, in France 615
- Enginehouse "Cleaning up," Muncie, by Harvey De Witt Wolcomb 265
- Enginehouse facilities, Improving 174*
- Enginehouse foreman, "Fired"—for the good of the service, a story by Harvey De Witt Wolcomb 37
- Enginehouse supervision, Notes on, by John F. Long 97
- Enginehouse, Work distribution in the, by John F. Long 262
- England, Tank locomotives 425*
- Equalizer brackets, Boring in place, C. & N. W. 649*
- Equipment, Heretofore due to defective, by William Queenan 251
- Equipment, Improve efficiency of 299
- Equipment, Increase of steel passenger, in service 386*
- Equipment orders in 1916 386*
- Equipment orders placed in June 386*
- Equipment situation, The, Railway 668*
- Equipment situation, The, Railway, Erie Railroad, Dining cars with unique table arrangement 229*
- Erie Railroad, Hospital car 37*
- Erie Railroad, Muffler for blowing down-broilers 502*
- Erie Railroad, Steel passenger equipment 387*
- Ernest, L., Exhaust separator for headlight service 70*
- Evans, G. S., Practical tests of freight car joint 10*
- Eye forming machine, by J. H. Chancy 210*
- F**
- Facing machine, Air valve 211*
- Failure, What is an engine? by W. J. 120*
- Failures, Analyze your engine 618
- Failures, The cost of equipment 628
- Failures, The cost of equipment, boiler sheets cold Fardell, E. P., Flaming 36*
- Fay & Egan Co., J. A., A ship band saw, Feedwater heating, Locomotive 284*
- Feedwater heating, Locomotive (Fuel Assoc.) 323*
- Feedwater, Study of boiler, by George L. Fowler 127*
- Feedwater treatment, A convenient method of boiler, Paige & Jones Chemical Co. 271
- File cleaning and sharpening machine, Macleod Co. 103*
- Filter and grease extractor, Lagonda Mfg. Co. 107*
- Filter, Automatic oil 451*
- Firebox, McClellon water-tube 239*
- Firebox temperature experiments 556*
- Firebox volume, Prevention of locomotive smoke, by J. T. Anthony 621*
- Fireboxes, Prolonging the life of, by Daniel Cleary 94
- "Fired"—For the good of the service, by Harvey De Witt Wolcomb 37
- Fires, Kindling, in locomotives, by H. B. Brown (Fuel Assoc.) 332*
- Firelocks, Height of 559*
- Firing engines at engine houses (Smoke Prevention Assoc.) 242
- Flange, Instructions in good, B. & O. 334
- Flange lubricator, H. S. Bank 49*
- Flue reclaiming attachment, Draper Mfg. Co. 354*
- Flux for oxy-acetylene welding of cast iron Foremen and officers, A responsibility of 473*
- Foreman, Plea of a 424*
- Foreman who fired himself, A, by Harvey De Witt Wolcomb 99
- Forging machine, Ajax Mfg. Co. 462*
- Forging machine dies, Design of, by E. R. Frost 645*
- Forging machine work at Silvis shops, Rock Island 583*
- Foster Machine Co., Universal turret lathe, Fowler, George L., A study of boiler feed 269*
- Fox Machine Co., Sections for multiple drill 159*
- France, Box cars built in America for 439*
- France, Cars used behind the trenches 498*
- France, Word from our railway men in 615
- Franklin Railway Supply Co., Flexible pipe connection 356*
- Fraser, J. G., Welding high-speed steel tips 158
- Front ends, Altering locomotive, by F. P. Roesch 176*
- Frost, E. R., Design of forging machine dies 645*
- Fry, Lawford H., The Kiesel locomotive tractive effort formula 69
- Fuel Association convention 301*, 323*, 332*, 383*
- Fuel, Canadian railway 407*
- Fuel, car department organization 422*
- Fuel department, Rock Island 434*
- Fuel economy and proper drafting of locomotives, by D. R. MacBain 130*
- Fuel economy, An additional incentive for, Fuel economy, Suggestions for (Fuel Assoc.) 301
- Fuel economy, Theory, practice and results of, by W. P. Hawkins (Fuel Assoc.) 304
- Fuel organization, Railroad 118*
- Fuel, Peat powder as a locomotive 76
- Fuel problem, The national 665*
- Fuel, Pulverized, for locomotives, by J. E. Minihel (A. S. M. E.) 415
- Fuel, Pulverized, for the railroads (Fuel Assoc.) 48
- Fuel records, Graphic display of individual, daily, by Hiram J. Slier (Fuel Assoc.) 383
- Fuel supply, Conserve your 284*
- Furnace for case-hardening with cyanide, A, by E. T. Spidv 91*
- G**
- Gage, Crank pin inspection, Jerome-Edwards Metallic Packing Co. 413*
- Gages for determining the lift of air pump inlet and discharge valves, by H. S. Waldron 322*
- Gaume, J. L., Interchange inspection (Car Foremen's Assoc.) 20
- Gasolene cautions 314*
- General Electric Co., Thermostatic metal 516*
- General Foremen's Association, Boosting the convention attendance competition articles 155
- Georgia Railroad, Alligator power shears 460*
- Georgia Railroad, Eye forming machine 210*
- Georgia Railroad, Ladder riveting machine, 102*
- Germany, Rolling stock situation in 610*
- Gibb Instrument Co., A magnetic pyrometer 49*
- Gibbons, J. W., Association competition article 201
- Gillespie, H. C., Forming knuckle pin nuts under the steam hammer 147*
- Gillespie, H. C., Tool for forming rod bushings 94*
- Givin, E. F., Method of increasing air pump capacity on double headed trams 435*
- Givin, E. F., Special shaped nozzles; the reason for their efficiency 120*
- Glass, E. F., Centering head of, for box cars, by Thos. R. Williams 237*
- Glass, E. F., Die for reboring compound air compressor cylinders 458*
- Glehn, Sr., M., Hot box competition article, Glover, George T., Service tests of steel springs 124*
- Grain car situation, The 227*
- Grain line, Calculating height of, for box cars, by Thos. R. Williams 636*
- Grant, James, Third prize article, Rod job competition 405*
- Grant, T. S., Second prize article, Engine terminal competition 699*
- Graphite cylinder lubricator, Automatic dry, United States Graphite Co. 270*
- Graphite lubricator, High Melting Point Co. 270*
- Grate bar, Elliptical, Thomas Grate Bar Co. 270*
- Grease cup plug, Mason, F. Mason 601*

Grease extractor, Filter and, Lagonda Mfg. Co. 107*

Great Northern, Folding horse for sheet metal work 584*

Great Northern, Machining shoes and wedges 147*

Great Northern, Rollers for applying eccentrics 706*

Great Northern, Saving money on tinware 511*

Great Northern, Time saving planer attachment 643*

Greenfield Tap & Die Corporation, Acorn die and holder 599*

Grinder, Portable truck wheel, by F. Osborne 212*

Grinders (see Machine tools).

Grinding and milling work 309*

Grinding machine, Angle cock, A. T. & S. F. 696*

Grinding machines (see Machine tools).

Grinding, Plain cylinder, by A. B. C. 641

Gould & Coupler Co., Truck lever type slack adjuster 600*

Guard, Water gage glass, Simplex Safety Boiler Gage Glass Co. 462*

Gustin-Bacon Mfg. Co., Air strainer for locomotive air pumps 48*

Gustin-Bacon Mfg. Co., Automatic freight car door lock 108*

Gustin-Bacon Mfg. Co., Journal box cooler 163*

H

Haanel, H. E., Hot box competition article. Hack saw machine (see Machine tools).

Hahn, J. H., Bar for boring Westinghouse main valve bushings 510*

Hahn, J. H., Lubricating air cylinders of cross-compound pumps 648*

Hall, William, Reclaiming wedges with broken flanges 39*

Hammer, pneumatic, Rivet cutting, Rivet Cutting Gun Co. 519*

Hanger, Brake beam safety, American Steel Foundries 162*

Hanson, F. H., Cut journal-owner defect 447

Hansen, Wm., Unnecessary transfer of loads 534*

Hauser, W. H., Converted switch locomotives 619*

Hauser, W. H., Making steam pipes by oxwelling methods 154*

Hawkins, W. P., Theory, practice and results of fuel economy (Fuel Assoc.) 304

Headlight equipment Electric, Locolight Co. 357*

Headlight rule, The new 28

Heater, A dining car water, by I. F. Dellonell 24*

Helm, J. E., Prize article, Hot box competition 22

Hemley Machine Co., 20-in. crank shaper 215*

Hennessey, H. J., Stresses on end framing of cars 582

Herblin, M., Lathe boring tools 584*

Herington, C. F., Powdered coal for blacksmith shops (Blacksmiths' Assoc.) 123

Hickok, W. H., Hot box competition article 197

Hickley, A. C., Boring cylinder and valve chambers 503*

Hisey-Wolf Machine Co., Ball bearing bench and floor grinders 352*

Hoist, Portable pillar, Ingersoll-Rand Co. 51*

Holder-on with automatic recoil, Staybolt, by Perry J. Swezey 264*

Hooks for lifting driving boxes 209*

Hooton, J. W., A novel planing device 158*

Horse for sheet metal work, Folding, Gt. Hose couplings, Emergency air and signal 688*

Hose, Safe life of air brake (Air Brake Assoc.) 443

Hose testing machine, by F. Osborne 514*

Houston, Stanwood & Gamble Co., Apron for heavy duty lathe 461*

Humphrey, A. J., Roller tool for finishing piston rods 148*

Humphrey, A. J., Shoe and wedge job 257*

Humphrey, A. J., Turning bolts in a bolt cutter 93*

Huntley, W. P., convention attendance competition article 68

Hydraulic Press Mfg. Co., Motor driven four-plunger pump 50*

I

Ideal Waste Check Co., Journal box waste check 214*

Illinois Central, Locomotive rod work at McComb, Miss. 503*

Illinois Central, Strengthening wooden furniture cars 437*

Illinois Central, Vaporizer for burning kerosene 263*

Illinois Central, Wood stock cars, and illumination, Show efficiency and, 610*

Indicator for placing jacks, by W. I. Kelly, Inc. 36*

Indicator, Thread lead, Bucknell-Thomas Co. 463*

Ingersoll-Rand Co., Portable pillar hoist 51*

Injector repairs, Emergency, by F. W. Bentley 407*

Inspection, Interchange, by J. J. Gainey (Car Foremen's Assoc.) 20

Inspection, Locomotive, Tobiasma Weno "Hack on the job" 424*

Inspection, Locomotive, "T. W. too sharp for the M. M." 534*

Inspection problems, Interchange, by W. H. Sagstetter (Car Foremen's Assoc.) 256

Inspection requirements, Federal (Gen'l Foremen's Assoc.) 589*

Inspection rules, Indication of Federal, Inspector of vital importance, Car, by Ithram W. Belpay 79

Insulation for passenger car floors, Tuco Products Corporation 464*

Insulation, Refrigerator car, B. & O. 685*

Interchange inspection, by J. J. Gainey (Car Foremen's Assoc.) 20

Interchange inspection problems, by W. H. Sagstetter (Car Foremen's Assoc.) 256

Interchange rules, Interpretation of, 23

International & Great Northern, Reclaiming wedges with broken flanges 39*

International Machine Tool Co., Libby high power turret lathe 349*

International Railroad Master Blacksmiths' Association (see Master Blacksmiths' Association) 123

International Railway Fuel Association (see Fuel Association).

Interstate Commerce Commission, Annual report of chief inspector of locomotive boilers 9, 664*, 680*

Interstate Commerce Commission, Division of Safety report, The 141

Interstate Commerce Commission, Locomotive inspection requirements (Gen'l Foremen's Assoc.) 589*

Interstate Commerce Commission, Modification of locomotive inspection rules 550

Inventions during the war, British 510†

J

Jacks, Indicator for placing, by W. J. Kelly Jack truck, Norton, by C. W. Schane 460*

Jacks with non-revolving screws, Bradney Machine Co., Inc. 709*

Jerome-Edwards Metallic Packing Co., Crank pin inspection gage 413*

Jesson, J. A., Babbitting valve rod cross-heads 262*

Jesson, J. A., Method of testing valves 644*

Jesson, J. A., Removing air pump pistons. Jig for use in upsetting axles and draw-bars, J. I. Lynch and H. Pfleger 463*

Joliet Railway Supply Co., Huntoon truck bolster 601*

Journal bearings, Anti-friction, a remedy that box competition 77*

Journal box competition, Hot 28

Journal box cooler, Gustin-Bacon Mfg. Co. 163*

Journal box, Hot—its cause and cure, The, by I. F. Lenke (Hot box competition) 135

Journal box, Hot, problem not insurmountable (competition articles) 21

Journal boxes, Hot, Carelessness and ignorance responsible for (competition article) 197

Journal boxes, Hot, Co-operation of all roads needed to reduce (competition article) 246

Journal boxes, Hot, The conductor's relation to the oiler (competition article) 146

Journal boxes, Hot, Educate the men (competition article) 78

Journal boxes, Hot, on freight cars 632

Journal boxes, Hot, Interest the men in (competition article) 254

Journal boxes, Hot, Lubrication of cars in interchange, by T. I. Burns 335

Journal boxes, Hot, Prevent, by education (competition article) 249

Journal boxes, Hot, reduced by following instructions (competition article) 136

Journal boxes, Hot, Three reasons for (competition article) 683

Journal box waste check, Ideal Waste Check Co. 214*

Journal, Cut—Owner's defect, by F. H. Hanson 447

Journal polisher, W. H. Basenberg 708*

K

Kadel, R. W., Virzman 120-ton coal car 493*

Kelley, R. G., Design of heavy belcal springs 477*

Kelly, W. E., Indicator for placing jacks 36*

Kerosene engine for McKee motor cars 465*

Kerosene, Vaporizer for burning, Ill. Cent. Keyway cutter, Portable piston rod and crosshead, Emmett G. Detrick 273*

Keyoke Railway Equipment Co., Draft gear attachment 411*

Kiesel locomotive tractive effort formula, by Lawford H. Fry 126

King, Harry, Hydraulic press and pump for rod bushing work 513*

Kropfowski, V. T., Power house economics 243, 373*, 675*

L

Ladder riveting machine, by J. H. Chancy, Lagonda Mfg. Co., The details of an arch tube cleaner 102*

Lagonda Mfg. Co., Filter and grease extractor 107*

Landis Tool Co., Horizontal boring, milling and drilling machine 215*

Landon, W. G., Tools for the workmen 424*

Lansreck, A. E., Firing engines at engine house 242

Lathe boring tools, by M. Herblin 584*

Lathe centers and drill press and milling machine sockets, by Carl G. Barth (A. S. M. E.) 43*

Lathe (see also Machine tools).

Lathe, Relieving attachment for engine 348*

Lathes, woodworking, Motor headstocks for, Westinghouse Elect. & Mfg. Co. 651

Leake, F. F., Hot box, competition article 135

Leech, C. C., A pilot snow plow 66*

Lehigh Valley, 2-10-2 and 4-6-0 type locomotives 231*

Liberty bond, Buy a 284*

Liberty loan, Second call for the 530*

Liberty loan subscription 406*

Light, Modern railway shop 515*

Link grinder, radial, by J. H. Chancy 207*

Link shaft bearings, Babbitting, by W. F. Schaphorst 512

Loading of cars, Importance of proper, by W. H. Bettecher (Car Foremen's Assoc.) 341

Loading lumber, Rules for 283*

Lock, Automatic freight car door, Gustin-Bacon Mfg. Co. 108*

Lock nut, Roller, Roller Nut Lock Co. 218*

Lock, Vestibule trap door, Tuco Products Corporation 461*

Locolight Co., Headlight equipment 357*

Locomotive

Ash pan, cast steel, Commonwealth Steel Co. 599*

Balance of, Cross, by C. H. Faris 561*

Boiler (see Boiler).

Car windows, Clear vision, R. R. & P. Crosshead shoes, Fastening, Charles Markel 49*

Cylinder and valve chambers, Boring, at the same time 503*

Cylinders with cracked steam passages reclaimed, by R. A. H. 504*

Design from a maintenance standpoint, by W. H. Wrenn 678

Design, New departure roller door, Tuco Products Corporation 369*

Design, Preliminary, by W. R. Maurer 551*, 655

Exhaust nozzles, Special shaped; the reason for their efficiency, by E. F. Given 120*

Exhaust pipe, variable, Russian locomotives 549*

Firebox (see Firebox).

Floes, end, Altering, by F. P. Roesch 176*

Headlight rule, The new 28

Inspection report, I. C. C. 664*, 680*

Inspection requirements, Federal (Gen'l Foremen's Assoc.) 589*

Inspection rules, Modification of Federal Maintenance, High points in 550*

Market 537*

Operation, Electric 186*

Orders in 1916 5*

Parts, Proper alignment of (Gen'l Foremen's Assoc.) 592*

Pilot, Cast steel, Commonwealth Steel Co. 599*

Pipes 430

Reciprocating parts, Light 110*

Repair Situation 538*

Repairs, False economy in 423*

Roll packing and swab holder, Paxton-Mitcheb Co. 217*

Safety chains, Tools for making, S. I. & S. F. 35*

Service, Standardization and improved, by Geo. Armstrong 153*

Superheater unit tester, C. R. I. & P. Tender design, An innovation in, Rock Island 673*

Terminal delays, by H. T. Bentley 639*

Terminal detention records, Penn. R. R. Tests, Mikado type, Penn. R. R. Tests of a Pennsylvania Atlantic type locomotive, by Andrew C. London 177*

Throttle valve, Russian locomotives, Tractive effort (see Tractive effort).

Valve bushings, Saving metal in, by W. I. Tobannon 44

Valve, Piston, for Russian Decapod locomotives 548*

Valve, Shukaloff drifting 549*

Valve, Zsibloff by-pass 549*

Wedges with broken flanges, Reclaiming, by William Hall 39*

Locomotive Stoker Co., Duplex stoker 408*

Locomotives

0-6-0 switch, Converted, C. & E. 1 619*

0-8-0 switchers from 2-8-0 type locomotives, Boston & Albany 488*

2-8-0, United States Army 484*

2-10-0 Pennsylvania Railroad 370*

2-10-0 Russian 545*

2-10-2, Denver & Rio Grande 431*

2-10-2, Lehigh Valley 331*

2-10-2, Southern Railway 381*

2-10-2, Wabash 667*

4-6-0, Lehigh Valley 231*

4-8-0 Madrid, Zaragoza & Alicante passenger 183*

*Illustrated article; †editorial; ‡short non-illustrated article or note; ††communication.

Locomotives—(Continued)

4-8-2, Southern Railway.....	381*
2-8-2-8, Southern Duplex.....	121*
2-8-2, Philadelphia & Reading.....	333*
2-8-8-4 Virginian Triplex (with inset)	64*
Electric, Advantages of.....	210†
Electric, Mechanical design of (A. S. Al. F.).....	75
Electric, Pennsylvania Railroad.....	379*
Handling at terminals.....	474
Better operation of.....	423‡
The war performance of.....	611‡
Tabular comparison of 0-8-0 and 0-6-0 types.....	18
Tabular comparison of 2-10-2 and 2-8-0 types.....	16
Tabular comparison of 4-8-2, 4-6-2 and 4-6-0 types.....	15
Tabular comparison of Mallet and 2-8-2 types.....	17
Tank, Modern British, by E. C. Poulton.....	425*
Long, John F., Notes on roundhouse super- vision.....	95*
Long, John F., Work distribution in the roundhouse.....	262
Loudon, Andrew C., Pennsylvania locomotive tests.....	177*
Louisville & Nashville, Babbitting valve rod crossheads.....	262*
Lubricants, Lack of, in Germany.....	465‡
Lubrication of air compressors.....	704
Lubrication of freight cars in interchange, The, by T. L. Burns.....	335
Lubricator for air cylinders of cross-compound air pumps, by J. H. Hahn.....	648*
Lubricator, Automatic dry graphite cylinder, United States Graphite Co.....	270*
Lubricator, Automatic flange, Swanson Au- tomatic Flange Lubricator Co.....	218*
Lubricator, Graphite, Elijah McCoy Mfg. Co.....	710*
Lumber, Rules for loading.....	283‡
Lyndon, George W., The chilled iron car wheel.....	249*
Lyons, J. C., Reinforced shoe and wedge.....	272*

M

MacBain, D. R., Fuel economy and proper drafting of locomotives.....	130*
McClellan water-tube firebox.....	239*
McGowan, A., Train line maintenance.....	189
McCoy Manufacturing Co., Elijah, Graphite lubricator.....	710*
McKen Motor Car Co., Kerosene engine for cars.....	465*
Machine tool demands, Foreign.....	613
Machine tool equipment in railway shops.....	4‡
Machine tool situation, The.....	306

Machine Tools

Boring bar, Portable column, Pedrick Tool & Machine Co.....	412*
Boring and facing machine, Tule, Pedrick Tool & Machine Co.....	51*
Boring machine, Horizontal, Pedrick Tool & Machine Co.....	107*
Boring machine, Locomotive cylinder and valve chamber, Newton Machine Tool Works.....	159*
Boring, milling and drilling machine, Horizontal, Landis Tool Co.....	215*
Cutting-off machines, Automatic metal, Nutter & Barnes Co.....	356*
Developments in railway shop.....	297
Drill, Radial, Morris Machine Tool Co.....	108*
Drill, Sensitive multiple, Fox Machine Co.....	159*
Drill and tapper, All-gear, Barnes Drill Co.....	351*
Drill, Triple purpose radial, American Tool Works Co.....	271*
Drilling machine with tapping attach- ment, Weikel Machine Tool Co.....	651*
Drills, Motor drive for radial, Cincin- nati Bickford Tool Co.....	652*
Grinder, Heavy duty car wheel, Putnam Machine Co.....	103*
Grinder, Type "C" Dumore portable, Wisconsin Electric Co.....	355*
Grinders, Ball bearing bench and floor, Casey-Wolf Machine Co., Startett Co.....	352*
Grinding machine, Heavy service plain, Brown & Sharpe Mfg. Co.....	213*
Grinding machine, Vertical surface, Reed-Prentice Co.....	353*
Grinding machines, Plain, Brown & Sharpe Mfg. Co.....	347*
Hack saw machine, S. Startett Co.....	48*
Lathe, Apron drive, heavy duty, Houston, Stanwood & Gamble Co.....	461*
Lathe, A car wheel, Niles-Bement- Pond Co.....	45*
Lathe, Heavy all-gear, head, Pitts- burgh Machine Tool Co.....	518*
Lathe, Heavy duty engine, Oliver Ma- chinery Co.....	109*
Lathe, Geared head, National Lathe Co.....	517*
Lathe, Light high power turret, Inter- national Machine Tool Co.....	349*
Lathe, Quick change, Mullinger Ma- chine Tool Co., Inc.....	160*
Lathe, Standard engine, Morris Ma- chine Tool Co.....	351*

Machine Tools—(Continued)

Lathe, Universal turret, Foster Ma- chine Co.....	269*
Milling machine tables, Power fast traverse for, Brown & Sharpe Mfg. Co.....	104*
New versus old.....	386‡
Planer, 30-in. by 30-in., Cincinnati Planer Co.....	350*
Power tests of, by C. H. Crawford.....	294*
Selection of, by Willard Doud.....	292
Shafer, Back geared crank, Queen City Machine Tool Co.....	354*
Shaper, 20-in. crank, Herdoy Machine Co.....	215*
Macleod Co., File cleaning and sharpening machine.....	103*
Madrid, Zaragoza & Alicante passenger lo- comotives.....	183*
Maintenance of air brakes on freight cars, by H. S. Walton.....	145
Maintenance, Freight car, by L. K. Silcox.....	533‡
Maintenance, Train line, by A. McGowan.....	189
Mallard, J. T., A removable driving box hub liner.....	598*
Malleable iron, Fallacies regarding, by A. H. Weston.....	481*
Malleable iron, How to tell.....	76†
Markel, Charles, Fastening crosshead shoes packing.....	49*
Markets, Car and locomotive.....	537*
Markets, Railway supplies and foreign.....	3‡
Marlow, George A., Why not have car de- partment apprentices? (Car Foremen's Assoc.).....	198
Marsh Refrigerator Service Co., Underframe reinforcement.....	578*
Marrett Packings Co., Cast iron piston rod packing.....	711*
Mason, F., Grease cup plug.....	601*
Master Blacksmiths' Association (see Black- smiths' Association).....	
M. C. B. Assoc., Letter ballot results.....	574*
M. C. B. rules, Cut journal—owner's de- fect, by F. H. Hanson.....	447
M. C. B. rules, Implications of.....	23
Material, Conserve.....	451
Material, Conservation of railway, by M. K. Barnum.....	670*
Material, Reclaiming car, Rock Island.....	627*
Material, Handling car department, by R. A. Doherty.....	567
Maurer, W. R., Preliminary locomotive de- sign.....	655
Mechanical department, "Do your bit"	287‡
Mechanical department a factor in train loading, by T. T. Ryan.....	624
Mechanical department, The future of.....	475‡
Mechanical department prospects for 1917.....	28
Mechanical department, Valuation of the.....	618
Mechanical department, valuation organiza- tion.....	283‡
Mechanical department, Wake up.....	535*
Mechanical department and the war, The.....	473‡
Mechanical engineer, An opportunity for the mechanical engineering, The value of.....	475‡
Mechanical Engineers, American Society of Mechanics, Shortage of, threatened.....	582†
	663‡
	368‡

Meetings

American Four-bymen's Association.....	521
American Gear Manufacturers' Assn.....	360
American Railway Tool Foremen's Asso- ciation.....	220, 360
American Society for Testing Materials Association of Manufacturers of Chilled Car Wheels.....	655
Boiler Makers' Supply Men's Associa- tion.....	276
Car Foremen's Association of Chicago, Car Inspectors' and Car Foremen's Asso- ciation.....	165, 220, 360
Central Railway Club.....	111
General Foremen's Association.....	111, 360
Interchange Car Inspectors' and Car Foremen's Supply Men's Association.....	276
International Association of Master Black- smiths' Association.....	415, 220
June Mechanical Conventions.....	111, 220
Master Boiler Makers' Association.....	54, 360
Master Car and Locomotive Painters' Association.....	360
Master Mechanics' and Master Car Builders' Association.....	467
Master Timbers' Coppersmiths' & Pipe- fitters' Association.....	360
New York Railroad Club.....	165
Pacific Railway Club.....	276
Railway Business Association.....	54
Railway Equipment Manufacturers' Asso- ciation.....	165, 360
Railway Supply Manufacturers' Asso- ciation.....	276
Richmond Railroad Club.....	655
St. Louis Railway Club.....	276
Traveling Engineers' Association.....	521
Western Railway Club.....	360
Mellin power reverse gear.....	667*
Men at home, The duty of.....	664‡
Men at home, The work of, by G. S. Ed- munds.....	664†
Mentor, J. C., Hot box, competition article	126
Midwestern mechanical valuation committee.....	197

Mileage of locomotives and cars, Increase.....	299
Military Equipment Standards Sub-commit- tee of Railway War Board.....	238*
Miller, Ernest A., Prize article, rod job, competition.....	317*
Milling cutter, Quick releasing face, Brown & Sharpe Mfg. Co.....	355*
Milling machine competition announcement.....	61‡
Milling machine practice, competition.....	117‡
Milling machine practice in railway shops, by C. A. Shaffer.....	397
Milling machine sockets, Lathe centers and drill press and, by Carl G. Barth (A. S. M. E.).....	43*
Milling machines in railroad shops, by Harvey De Witt Wolcomb.....	321
Milling machines (see also Machine tools). Milling work, Grinding and.....	309*
Minneapolis, St. Paul & Sault Sainte Marie, Method of making tube expanders.....	98*
Minneapolis, St. Paul & Sault Ste. Marie, Universal driving box chuck.....	647*
Mitchell, K. R., Engine terminal competi- tion, third prize article.....	700
Morris Machine Tool Co., Radial drill.....	108*
Morris Machine Tool Co., Standard engine lathe.....	351*
Motion picture study of height of fire doors	559*
Motive power capacity, More.....	664‡
Motive power conditions.....	117‡
Motive power, Conserve the.....	369‡
Motive power, Efficiency of.....	174‡
Motive drive for radial drills, Cincinnati Bickford Tool Co.....	652*
Motor headstock for woodworking lathes, Westinghouse Elect. & Mfg. Co.....	651
Motors, Automatic starter for induction, Electric Controller & Mfg. Co.....	653*
Motors, Kerosene, for McKeen cars.....	465*
Motion picture collision.....	187*
Muffler for blowing down boilers, by C. W. Schane.....	592*
Muhlfield, J. E., Pulverized fuel for loco- motives (A. S. M. E.).....	11
Mullinger Machine Tool Co., Inc., Quick change lathe.....	160*
Murray, E. A., Pneumatic shearing machine.....	455*

N

Nagle, J. H., Clear vision windows.....	649*
Nashville, Chattanooga & St. Louis, Exter- nal rod posts for planing cylinders.....	158*
Nashville, Chattanooga & St. Louis, Lathe boring tools.....	584*
Nashville, Chattanooga & St. Louis, Oil- electric motor car.....	491*
National Acme Mfg. Co., A collapsing tap.....	104*
National Lathe Co., Geared head lathe.....	517*
National Tube Co., A demonstration of the flexibility of steel pipe.....	708*
New York, Chicago & St. Louis, Chuck for finishing piston valve packing rings.....	407*
New York, New Haven & Hartford, Elec- trical equipment repair shops.....	203*
Newton Machine Tool Works, Locomotive cylinder and valve chamber boring ma- chine.....	159*
Niles-Bement-Pond Co., A car wheel lathe.....	45*
Norfolk & Western, Hydraulic press and pump for rod bushing work.....	513*
Norton, A. W., Educate the trainmen.....	666†
Norton, E. S., Assisting shrinkage in autog- enous welding by mechanical means.....	263*
Nutter & Barnes Co., Automatic metal cut- ting off machines.....	356*

O

Officers and foremen, A responsibility of.....	473‡
Oil filter, Automatic, by E. A. M.....	451*
Oil, Insoluble impurities in.....	251†
Oldham & Son Co., George, Valveless hoiler scaler.....	354*
Oliver Machinery Co., Heavy duty engine lathe.....	109*
Operation, Electric locomotive.....	186
Oregon Short Line, Boring cylinder and valve chambers.....	503*
Oregon-Washington Railroad & Navigation Co., Jig for planing outside of cross- head shoes.....	648*
Organization and efficiency, Car depart- ment, by C. R. Dobson (Car Foremen's Assoc.).....	24
Organization, Fuel department.....	422‡
Orifice method of determining train brake leakage.....	629*
Osborne, F., Hose testing machine.....	514*
Osbourne, F., Portable truck wheel grinder, by E. T. Spidy.....	212*
Output, Increasing, and reducing unit costs, by E. T. Spidy.....	315*
Output required, Greater shop.....	287‡
Oxy-acetylene, Cutting holes in side rods with, C. R. I. & P.....	455*
Oxy-acetylene process, Special tip for cut- ting rivet heads by, Prest-O-Lite Co.....	464*
Oxy-acetylene welding (see Welding).....	
Oxygen, Cutting steel with.....	264†

P

Personals—General—(Continued)

Personals—Master Mechanics and Road Foremen of Engines—(Continued)

Packing and swab holder, Rod, Paxton-Mitchell Co. 217*

Packing, Cast iron piston rod, The Martell Packing Co. 711*

Purge & Jones Chemical Co., A convenient method of boiler feed water treatment. 271

Paint for freight cars "One Coat," by J. H. Pitard 193

Paint, Practical tests of freight car, by G. S. Evans 19*

Painters, Master, tell of benefits from convention attendance (Association competition articles) 201

Patches for locomotives, Boiler, by M. J. Cairns 259*

Paxton-Mitchell Co., Rod packing and swab holder 217*

Pest powder as a locomotive fuel 76

Pedrick Tool & Machine Co., Horizontal boring machine 107*

Pedrick Tool & Machine Co., Portable column boring bar 412*

Pedrick Tool & Machine Co., Tube boring and facing machine 51*

Pennsylvania Railroad, Decapod type locomotive 370*

Pennsylvania Railroad, Electric locomotive. Pennsylvania Railroad, Grinding and milling work 309*

Pennsylvania Railroad, Height of fire doors 559*

Pennsylvania Railroad, 85-ton hopper cars. 191*

Pennsylvania Railroad, Locomotive brick arch tests 235*

Pennsylvania Railroad, Locomotive terminal detention records 625*

Pennsylvania Railroad, Locomotive tests, by Andrew C. London 177*

Pennsylvania Railroad, Mikado type locomotive tests 328*

Pennsylvania Railroad, Refrigerator cars. Performance, Interesting back shop 401*

Perolin Railway Service Co., A boiler metal treatment 50

Personals—General

Alexander, Walter 277*

Anderson, J. W. 522

Armstrong, Samuel T. 54

Bardwell, R. C. 277

Barnes, Clyde E. 714

Barnum, Morgan King 166*

Beam, W. J. 603*

Benger, F. C. London 522

Bennett, R. G. 166

Bennett, W. I. 361

Berg, Karl 522

Bradley, Wm. H. 522

Brown, H. B. 522

Burgess, T. B. 656

Bussing, G. H. 415

Cinder, W. C. H. 714

Crawford, C. H. 714

Crawford, D. F. 54

Crolley, B. F. 656

Cunningham, D. G. 714

Cunningham, J. L. 361*

Deats, G. W. 715

Devens, W. D. 166

Deverill, A. 656

De Villiers, E. B. 656

Duoley, W. H. 112

Junham, Walter E. 522*

Dwyer, J. R. 468

Eddy, W. J. 277

Eich, H. C. 603, 656*

Empie, H. A. 523

Faherty, T. K. 54

Fetner, Wm. H. 604, 604

Fulmer, J. H. 604

Gaines, F. F. 604

Gill, Charles A. 166

Gimshaw, F. G. 468*

Grove, Paul L. 604*

Hall, E. B. 415

Hamilton, T. H. 221

Hamilton, T. H. 468

Hammond, G. O. 523, 604

Hanlin, John J. 468, 523*

Hawkins, R. D. 656

Henry, John M. 657*

Hibbits, F. N. 604

Hicks, J. C. 221

Hodapp, F. 656

Honaker, H. 166

Hungerford, Samuel I. 656, 214*

Huston, F. T. 112

Jackson, E. R. 657

Johnson, Ben 361

Jones, C. E. 54

Kellogg, Daniel P. 221, 277*

Kellogg, W. L. 166

Kelly, William 657

Kelly, W. M. 657

Kinnaird, I. S. 604, 657*

Ktobn, Arthur 361

Lavalle, J. L. 715

Lee, R. E. 715

Lemen, W. W. 715

Lucas, A. N. 361

McCormick, George 54*

McGowan, G. W. 715

McMurry, W. L. 715

McGoff, J. H. 221

McQuillen, J. E. 277

Macbeth, H. A. 657

Manly, Charles 657, 715

Maxfield, H. H. 361*, 468

May, H. C. 604

Milliken, James 361

Milner, B. B. 468

Moriarty, G. A. 361*

Murrian, W. S. 112

Nelson, William 523

Nichols, Grover C. 54, 112

Penrose, E. S. 715

Pennington, H. R. 362*

Perine, David M. 54

Power, J. A. 166

Ramage, J. C. 112*

Reese, Oliver P. 54, 112*

Robb, W. D. 523*, 535

Sample, W. H. 605*

Sasser, E. C. 112

Schlegel, William 415, 715

Scholz, Carl 415*

Slutzker, Joseph 468

Smith, Jr., P. F. 55, 112*

Starke, Claude M. 657*

Stewart, C. T. 362*

Taylor, F. J. 55

Thompson, E. F. 277

Tinton, M. 715

Voight, A. E. 408

Wallis, J. T. 523

Waring, Francis M. 604

Whitsitt, William B. 715

Wilkin, George W. 523*, 535*

Williams, K. J. 604

Wilson, Amos 221

Witchell, A. J. 657

Wood, W. R. 657

Yoerg, Henry 657

Young, C. D. 362*, 523

Young, Jr., James 605

Personals—Master Mechanics and Road Foremen of Engines

Allen, Harry C. 55

Allen, L. L. 715

Armstrong, A. G. 221

Baals, D. D. 277

Barrett, C. D. 468

Battle, E. R. 605*

Beirne, Andrew H. 468, 523*

Bennett, Robert G. 468*

Bess, C. E. 35

Bjms, A. H. 277

Berry, John 166

Brinson, S. A. 166

Brown, A. L. 362

Buckbee, E. J. 277

Burket, C. W. 605

Byron, A. W. 605

Cessford, G. F. 468

Chapman, I. 523

Cherry, W. A. 221

Christy, George C. 468

Clark, R. J. 658

Coe, T. W. 658

Coulter, J. W. 715

Creager, C. H. 658

Cuyler, J. W. 221

Dales, A. E. 415

Davey, T. S. 715

Davis, B. H. 605

Deason, A. R. 166

Delaney, J. A. 715

Dinan, A. 166

Diven, James B. 605

Donaldson, Thomas C. 362

Donellan, Joseph F. 166

Douglas, E. J. 277

Dowling, I. J. 658

Drake, I. H. 166

Dyer, W. H. 277

Dymond, F. E. 55

Eagan, James T. 166

Eakin, W. H. 55

Emerson, H. F. 166

Ernstman, George L. 221

Fleming, M. J. 658

Galloway, A. K. 167

Gaskill, C. S. 469

Grubbins, C. 55, 523

Hale, O. R. 166

Halliwell, Charles J. 605*

Hambley, T. 523

Handford, John 55

Harden, F. H. 221

Harris, E. J. 362, 715

Harrison, W. R. 715

Harvey, Heber L. 523

Hoban, M. P. 523

Hyde, C. W. 167

Ingram, W. N. 167

Jackson, J. W. 524

Jamison, J. 277

Johnson, W. B. 112

Johnston, W. D. 524

Jones, Lloyd B. 112

Jones, Paul 55

Karibo, I. J. 221

Keagy, Charles O. 658

Keller, W. H. 715

Kelso, Christopher 362*

Kidwell, Albert H. 277

Kircher, I. G. 658

Lawless, Edward 658

Le Van, E. B. 55

Libert, G. H. 415

Lindsay, E. 524

Long, D. J. 221, 469

McDonald, A. 605

McDonald, F. P. 468

McDonald, Richard J. 55

McGurk, Charles W. 605

Mellvaine, Charles L. 363*, 658

McKenzie, H. D. 167

McLean, W. J. 605

McMillan, A. E. 167

McMillan, E. S. 658

McPartland, M. G. 658

McPherson, W. G. 362

Malthaner, William 167

Marsh, Franklin E. 606

Mattimore, J. A. 221

Maxwell, O. E. 362

Meeder, William R. 468, 524

Mendell, H. P. 658

Meredith, H. P. 659

Moler, A. I. 524

Moran, W. F. 167

Morgan, Dwight C., Jr. 362

Moth, George 221

Murphy, T. N. 167

Nordham, H. L. 469

O'Brien, William E. 362

Ondvic, A. E. 606

Peck, C. E. 715

Pfahler, F. P. 363

Pohler, Victor U. 606

Price, T. M. 524, 659

Rafferty, C. D. 469

Reed, T. L. 524

Rhark, F. W. 657

Richers, George J. 113

Robbins, F. S. 469

Roddie, E. C. 659

Roesch, A. 221

Ronaldson, F. 167

Roomey, T. H. 221

Ruiter, A. R. 221

Sample, W. H. 55

Schmoll, G. B. 363

Schoenky, O. B. 459

Schultz, Edward 469

Schultz, F. W. 659

Schum, Harry S. 469

Sharp, C. I. 277

Smith, D. M. 277

Smith, E. P. 658*

Smith, E. W. 658*

Smith, M. F. 469

Starkweather, Leon A. 469

Steel, J. R. 221

Stevens, H. H. 167

Stevens, O. R. 524

Stoops, W. F. 167

Thomas, J. H. 469

Thomas, Louis E. 55

Thompson, R. K. 278

Trachta, G. P. 277

Varnell, D. H. 167

Walsh, M. K. 659

Watkins, G. H. 469

Watson, J. W. 524

Wells, W. 363, 524

Werth, C. A. 715

Williams, A. D. 524

Williams, F. 524

Williams, Irving 167

Wilson, G. M. 606

Winn, C. F. 363

Wortman, W. H. 416

Wright, Orville C. 112, 658*

Younie, Alexander 469

Personals—Car Department

Alquist, P. 167

Amor, W. J. 525

Borrowdale, J. M. 221

Barnett, R. W. 525*

Caton, S. W. 363

Chesterman, A. E. 167, 278

Craig, J. S. 55

Craig, G. H. 55

Crosby, R. 715

Fitzgerald, L. C. 525

Hall, James 278

Hemmway, T. A. 606

Layton, A. 525

Kleaver, T. P. 167

McClear, C. W. 278

O'Neil, J. E. 606

Peat, W. 278

Stokes, C. R. 55

Tasker, A. E. 167, 278

Thomas, W. 525

Walter, P. S. 416

Zercher, F. B. 55

Personals—Shop and Enginehouse

Abington, W. T. 363

Adams, A. C. 606

Baron, B. 278

Bischel, Paul 363

Black, William F. 659

Breckefeld, J. C. 606

Brennan, E. J. 363

*Illustrated article; †editorial; ‡short non-illustrated article or note; ††communication.

Personals—Shop and Enginehouse—(Continued)

Brewer, H. W. 606
 Cooper, Frank E. 469
 D'Ass, Amos C. 469
 Davis, Charles W. 469
 Downs, William R. 278
 Flanders, H. G. 469
 Flesher, F. G. 363
 Fraser, John 278
 Fuller, A. 469
 Gahle, B. 715
 Gibbs, Lyle H. 469
 Gilles, J. E. 525
 Greiser, Joseph 469
 Gruys, William 469
 Hall, W. G. 416
 Hayward, S. 416
 Hendricks, L. W. 221
 Hoey, K. 525
 Howell, F. P. 469
 Iverson, E. 525
 James, W. H. 715
 Jamieson, I. L. 113
 Keebler, Arthur T. 363
 Leach, John 113
 Lydon, H. A. 363
 MacRae, John 416
 McAllester, Joseph 525
 McGowan, J. 278
 McLean, Arthur W. 221
 Meyer, E. S. 55
 Guntmer, G. 416
 Muir, Stephen E. 416
 Muir, J. D. 221
 Myers, Frank E. 469
 Nash, F. P. 416
 Neff, A. P. 221
 Newbury, E. H. 629
 Spinger, H. E. 469
 Ochsby, J. W. 363
 Oshourn, F. 363
 Parslow, Samuel R. 469
 Poole, E. P. 416
 Praet, G. P. 278
 Reese, B. 525
 Reid, John 278
 Schoenky, O. B. 469
 Scott, W. W. 469
 Small, W. 525
 Spicer, H. C. 469
 Sproule, A. L. 525
 Steeves, G. R. 525
 Steylmeier, A. 363
 Stout, R. B. 525
 Scales, J. W. 525
 Temple, J. S. 416
 Voelker, H. R. 659
 Vogel, Samuel 659
 Von Blucher, L. F. 416
 White, C. 278
 Williams, E. V. 600
 Young, T. C. 363

Personals—Purchasing and Storekeeping

Agner, R. L. 715
 Anderson, H. A. 659
 Austin, Frank S. 278
 East, P. E. 278
 Baxter, Ernest 364
 Benson, Roy 221
 Best, J. A. 167
 Boardman, E. W. 606
 Brackett, J. A. 606
 Byron, John E. 606
 Cochrane, A. L. 659
 Davids, C. N. 606
 Davidson, William 606
 Denman, S. G. 715
 Dewart, H. M. 606
 Drossel, L. E. 606
 Edrill, T. S. 606
 Edrill, W. W. 715
 Eseh, J. F. 659
 Fawcett, T. 469
 Feemster, J. L. 278
 Ferguson, J. H. 113
 Goodwin, E. G. 278
 Griffin, Edward Ormond 55
 Hinkley, Benjamin S. 416
 Hiner, W. L. 416
 Hixon, G. O. 606
 Jones, B. T. 221
 King, Leonard L. 416
 Langham, E. 469
 Langston, E. F. 469
 Linn, William A. 56
 Livingston, John B. 167
 Lordan, R. 167
 Ludington, C. F. 278
 MacSwain, F. B. 113
 McAniff, Eugene 606
 McCann, Bayless 278
 McDowell, E. 278
 McOuilkin, J. P. 167
 Madden, T. W. 607
 Morehead, William S. 363
 Morgan, H. L. 56
 Morgan, J. H. 715
 Morrison, E. 469
 Mulcahey, A. H. 56
 Munster, August W. 416
 Nelson, R. M. 56
 Pace, Robert T. 221
 Phillippe, B. P. 659
 Pouton, H. D. 56

Personals—Purchasing and Storekeeping—(Continued)

Porter, C. B. 56
 Omeikel, R. D. 167
 Reed, F. D. 715
 Reed, H. J. 167
 Rouse, H. E. 168
 Ryan, Thomas H. 363
 Saye, S. W. 278
 Scott, Robert E. 650
 Shanks, H. P. 364
 Shields, E. J. 715
 Shoemaker, H. 113
 Spann, H. R. 607
 Steen, W. E. 607
 Stewart, W. D. 525
 Tibbs, B. 607
 Sturges, W. F. 221
 Summerhays, W. A. 364
 Walters, G. H. 607
 Ware, W. C. 168
 Warnecke, John G. 364
 Whiteley, W. G. 168
 Winkless, C. T. 278, 715

Personals—Commission Appointments

Nelson, Charles A. 416

Personals—Obituary

Acker, Charles B. 221
 Buchanan, Jr., Archibald 168
 Enright, J. 607
 Heath, John 364
 Hickey, John 168
 Keegan, J. F. 221
 Kenzie, Roscoe B. 364
 McAndrew, Michael J. 278
 Manchester, Albert E. 364
 Minton, W. D. 168
 Monkhouse, Henry 56
 Price, George H. 278
 Stott, Henry Gordon 168
 Strattan, George W. 278
 Turner, Charles T. 168
 Walz, W. C. 221
 Wills, James D. 168
 Wood, C. S. 607

Philadelphia & Reading, Mallet locomotives. 333
 Philadelphia & Reading, Pneumatic bolt clamp 35
 Piece work and the car inspectors' duties, by W. H. Sitterly 628
 Tidcher, J. A., Economics of car design 565
 Pilot, Cast steel, Commonwealth Steel Co. 459
 Pipe center, Ball, by A. M. 459
 Pipe connection, Flexible Franklin Railway Supply Co. 356
 Pipe, Demonstration of ductility of steel 708
 Pipe expansion joint with a crosshead guide, Ross Heater & Mfg. Co. 357
 Pipe, Life of cast iron 541
 Pipe, Loss of head due to bends in, Whittington Pipe & Foundry Co. 2647
 Piston rod and crosshead keyway cutter, Portable, Emmett G. Dietrick 273
 Piston rod packing, Cast iron, The Martell Packings Co. 711
 Piston rods, Roller tool for finishing, by A. J. Humphrey 148
 Pirard, J. H., "One coat" paint for freight cars 193
 Pittsburgh Locomotive Power Reverse Gear Co., Positive locking reverse gear 411
 Pittsburgh Machine Tool Co., Heavy all-gear-head lathe 518
 Pittsburgh, Shawmut, Capacity on double-headed trains 435
 Plauer, A time-saving attachment for the, Gt. Nor. 643
 Plauer (see also Machine tools) 158
 Planing device, A novel, by J. W. Hooton, Pneumatic carrier, by M. K. 93
 Polishing and finishing machine, Abrasive belt, Blevney Machine Co. 652
 Postage proposed for magazines, Higher 18
 Postal profits, Federal 618
 Poultny, E. C., Modern British tank locomotives 425
 Powdered coal for the railways (Fuel Assoc.) 485
 Powdered coal for blacksmith shops, by C. F. Harrington (Blacksmiths' Assoc.) 369
 Power, Conserve the motive 123
 Power house economics, by V. T. Kropilowski 675
 Power, More motive, Capacity 6648
 Power tests of machine tools, by C. H. Crawford 294
 Press, Air, for rod bushings and driving box brasses 588
 Press, Portable crank pin, Watson-Stillman Co. 650
 Press and pump for rod bushing work, Hydraulic, by Harry King 513
 Prest-O-Lite Co., Special tin for cutting Prest-O-Lite Ladder, by H. H. Cheney 464
 Preston, R. L., Air hose connection for pits 451
 Prices, Advance in material 430
 Prices, Car and locomotive 430
 Production of locomotive repair parts, Centralized, by George Armstrong 280
 Propriety in engineering societies, Tech 448
 Prospects for 1917, Mechanical department, 28

Protest, A—educate the trainmen, by R. J. Quintrell 612
 Pulverized coal in Brazil, Use of 617
 Pulverized coal plant for the Santa Fe 187
 Pulverized fuel for locomotives, by J. E. Mottfield (A. S. M. E.) 11
 Pump, Motor driven four-plunger, Hydraulic Press Mfg. Co. 50
 Punch, Flat, for Ajax bolt machine, by C. W. Schane 459
 Punching machine, Pneumatic, by F. J. Borer 695
 Purifying shop drinking water, by W. S. Whitford 202
 Putnam Machine Co., Heavy duty car wheel grinder 103
 Pyrometer, A magnetic, Gibb Instrument Co. 49
 Pyrometer, Spring support for, by M. K. 211

Q

Queen City Machine Tool Co., Back geared crank shaper 354
 Queenan, William, Steel gondola versus composite gondola 253
 Queenan, William, Derailments due to defective equipment 251
 Quintrell, R. J., A protest—educate the trainmen 612

R

Rack for storing boiler sheet stock, by C. L. Dielert 314
 Rail pressure from main rod thrust, by J. Paul Shamberger 181
 Railroads and the war, The 2278
 Railways in the war, Prompt action by the, Rauch, H. S., A flange lubricator 49
 Rawhide pinions, Compounds for 626
 Readjustment to present conditions 2298
 Reamer, An exploded 454
 Reardon, E. S., Device for reboring dies 98
 Reclamation of car material, Rock Island 627
 Reclamation of cast iron wheels 406
 Reclamation of cylinders with cracked steam passages, by R. A. H. 504
 Read-Prentice Co., Vertical surface grinding machine 353
 Refrigerator, Heater & Ventilator Car Co., Tests of Moore heater car 710
 Regiment, Railway engineers now in France 543
 Regiment, 19th Engineers, Word from, in France 615
 Regiments' tobacco fund, Railway 616
 Regulator, Brake cylinder pressure, 438
 Reinforcing freight car draft sills, by Lewis 195
 Repair parts, Centralized production of locomotive, by George Armstrong 280
 Repair problems, Freight car, by Lewis K. Silcox 137
 Repair situation, Freight car 5318
 Repair situation, Locomotive 5358
 Repair track carriages, Locomotive 618
 Repairs, False economy in locomotive 4238
 Repairs, Make to equipment more promptly 299
 Repairs, Quick locomotive, Delaware & Hudson 401
 Repairs, Some Oxy-Acetylene 591
 Repairs to straight air brake valve, Emergency, by F. W. Breyer 268
 Repairing cracks in the flange of tube sheets, by Daniel Cleary 158
 Report, Locomotive boiler inspection 6648
 Report of chief boiler inspector of J. C. C. 680
 Report of the chief inspector of locomotive boilers, Annual 9
 Report of J. C. C. Division of Safety 14
 Resistance of messenger cars, by E. C. Schmidt and H. H. Dunn 247
 Reverse gear, Lewis power, Commonwealth Supply Co. 707
 Reverse gear, Mollin power 667
 Reverse gear, Positive locking power, Pittsburgh Locomotive Power Reverse Gear Co. 411
 Reverse gear, Type "H" Ragonnet, Economy 597
 Rings, Steam pipe joint, Chicago Great Western 9
 Rivet cutting gun, Rivet Cutting Gun Co. 519
 Riveter for steel cars, Gap, by "Apecs" 588
 Riveting machine, Hanna pneumatic, Vulcan Engineering Sales Co. 217
 Riveting machine, Ladder, by H. H. Cheney 102
 Rod brasses, Chuck for shaping main, C. R. & O. 696
 Rod bushing work, Hydraulic press and pump for, by Harry King 513
 Rod job competition 2838
 Rod job competition announcement, Locomotive 1178
 Rod job competition, Locomotive 1738
 Rod job, competition, prize article 317
 Rod repairs, Handling (Third prize, competition article) 405
 Rod work on the Chesapeake & Ohio (competition article) 300
 Rod work, Locomotive, (competition article) 503
 Rod work, Suggestions for competition article, Tech 513
 Rods, Cutting holes in side, with oxy-acetylene, C. R. L. & P. 455

*Illustrated article; †editorial; ‡short non-illustrated article or note; ††communication.

Rods, Handling, at Macon shops (competition article) 449*

Rods, side, Milling jaws in, by M. H. Westbrook 476†

Rods, Repairing main and side, by M. F. Cox 457*

Rodenbur, John T., Extension coach step 163*

Roesch, F. P., Altering locomotive front end 176†

Roesch, F. P., 1st prize article, convention attendance competition 67

Roesch, F. P., Hot box competition article 23

Roller Nut Lock Co., Roller lock nut 218*

Ross Heater & Mfg. Co., Expansion joint with a crosshead guide 357*

Routing work in railroad shops 238

Rules, Interpretations of, M. C. B. 23

Rules for loading lumber 283

Rules, Modification of Federal locomotive inspection 550

Russ Forged Drill Co., A. E., Forged twist drill 518*

Russia, Decapod locomotives for 545*

Russia, Equipment situation in 603

Russia, Railway loan 544†

Ryan, T. T., Mechanical department a factor in tram loading 624

Ryerson & Son, Joseph T., Boiler tube reclaiming machine 162*

S

St. Louis-San Francisco, High speed steel tipped tools 643*

St. Louis-San Francisco, Tools for making locomotive safety chains 35*

Safety appliance standards, The, by Hiram W. Belnap 393*

Safety appliances, Application of 173

Safety appliances, Hearing on 188

Safety device, Blue signal, Acar Mfg. Co. 410*

Safety first 452

Safety first, Hand tools and 450*

Safety hanger for brake rigging, Elgin, Joliet & Eastern 448*

Safety standards for cranes 70†

Safety valves, Locating defective, by F. W. Bentley, Jr. 267*

Sagstetter, W. H., Interchange inspection problems (Car Foremen's Assoc.) 256

Sand blast for cleaning flue sheets, by M. K. Saw, A ship hand, L. A. Fay & Egan Co. 160*

Sealer, Valveless boiler, George Oldham & Son Co. 354*

Schane, C. W., Flat punch for Ajax bolt machine 459*

Schane, C. W., Muller for blowing down boilers 592*

Schane, C. W., Norton jack truck 460*

Schane, C. W., Reclaiming air compressor stuffing boxes 212*

Schaphorst, W. F., Babbitting line shaft bearings 512

Schmidt, E. C., Resistance of passenger cars 247*

Schmechger, Joseph, Welding a cracked cylinder 322

Schradler, J. R., Passenger car work 77

Schradler, J. R., Convention attendance competition article 155

Scrap, Need for the utilization of 423

Scrap, Reclamation of car, Rock Island 627*

Scrap, Saving effected by breaking, B. R. & P. 237*

Scrap, War 218†

Screws, Tools for turning and threading small, by W. S. Anderson 211*

Seidler, F. W., Driving box spring seat milling machine 397*

Seidler, F. W., Method of making tube expanders 98*

Selection of machine tools, by Willard Doud 292

Separator for headlight service, Exhaust, by L. Ernest 70*

Shaffer, C. A., Milling machine practice in railway shops 397

Shamberger, J. Paul, Rail pressure from main rod thrust 181*

Shaper (see Machine tools).

Shear, Portable motor driven, Buffalo Forge Co. 519*

Shearing machine, Pneumatic, by E. A. Murray 455*

Ships, Alligator power, by J. H. Chaney 460*

Shipman, H. L., Hot boxes 683

Shipping, Shortage of, in Australia 430†

Shocks on steel equipment, Collision 173

Shoe and wedge job, by Arthur J. Humphrey 257*

Shoe and wedge, Reinforced, L. C. Lyons 272*

Shoes and wedges, Machining, Great Northern 147*

Shop efficiency and illumination 610

Shop equipment, Keep the, in repair 307

Shop equipment number 227

Shop equipment, Securing new, "And then the worm turned," by Harvey De Witt Wolcomb 456

Shop forces, Conserve the 119†

Shop Kinks

Air valve facing machine, A. T. & S. F. 211*

Angle cock grinding machine, A. T. & S. F. 696*

Babbitting valve rod crossheads, L. & N. 262*

Boring bar for use on cylinders and valve chambers at the same time, Oregon Short Line 503*

Shop Kinks—(Continued)

Boring bar for Westinghouse main valve bushing 510*

Boring equalizer brackets in place, C. & N. W. 649*

Car wheel borer adapted to boring and facing driving boxes 264*

Centering machine, by E. F. Glass 153*

Chuck for finishing piston valve packing rings 407*

Chuck for milling C. hooks and wedges, Great Northern 147*

Chuck for shaping main rod brasses, C. B. & O. 696*

Die for forming strainer brasses 212*

Dies for repairing threads on crosshead pins 587*

Dies for swedging superheater flues, Steam hammer, C. Hook, N. W. Wedges 640*

Driving box chuck, Universal, M. St. P. & S. S. M. 642*

Driving box spring seat milling machine 397*

Eye forming machine, Georgia Railroad 210*

Furnace for case-hardening with cyanide, A. by E. T. Spidy 91*

Granier, Portable truck wheel, by F. Osbourne 212*

Holder-on with automatic recoil, Stay-bolt, by Perry I. Swezey 264*

Hooks for lifting driving boxes 209*

Horse for sheet metal work, Folding, Gt. Nor. 584*

Hose testing machine, Canadian Pacific 514*

Hydraulic press and pump for rod bushing work, Norfolk & Western 513*

Jig for planing outside of crosshead shoes, Oregon-Washington Railroad and Navigation Co. 648*

Jig for re boring compound air compressor cylinders, by E. F. Glass 458*

Keyway cutter, Portable piston rod and crosshead 273*

Knuckle pin nuts, Forming, under the steam hammer, C. & O. 147*

Lathe boring tools, Nashville, Chattanooga & St. Louis 584*

Link grinder, Radial, Georgia Railroad, Locating defective safety valves, by F. W. Bentley, Jr. 267*

Muller for blowing down boilers, Erie Railroad 592*

Nut, Blind, for removing air pump pistons, by J. A. Jesson 510*

Planer attachment, A time saving, Gt. Nor. 643*

Planing cylinders, Extension tool posts for, N. C. & St. L. 158*

Pneumatic pump, P. K. R. 35*

Pneumatic carrier, by M. K. Saw 93*

Pneumatic churning machine, Central Railroad of New Jersey 695*

Press, Air, for rod bushings and driving box brasses 588*

Punch, Flat, for Ajax bolt machine, by C. W. Schane 459*

Re boring distributing valves, Device for, by E. S. Reardon 98*

Reclaiming, Air compressor stuffing boxes, by C. W. Schane 212*

Reducing wear in driving box cellar bolt holes, by H. C. Spicer 258*

Riveter for steel cars, Gap, South African Railway 588*

Riveting machine, Ladder, Georgia Railroad 102*

Rollers for applying eccentrics, Gt. Nor. Safety chains, Tools for making, St. L. & S. F. 35*

Sand blast for cleaning flue sheets, by M. K. Saw 91*

Shearing machine, Pneumatic, C. & O. Shears, Alligator power, Georgia Railroad 455*

Shield for tempering blast, Chicago & North Western 695*

Stahlbolck chuck, A handy 452*

Steam pipe joint rings, C. G. N. 9*

Superheater unit tester, C. R. I. & P. 153*

Testing air pumps and steam heat governor valves, by J. A. Jesson 644*

Testing freight car bump in yards, Alligator power, by M. K. Saw 148*

Tool for finishing piston rods, Roller, by Arthur J. Humphrey 148*

Tool for forming high speed steel tips for lathe tools, St. Louis-San Francisco 643*

Tool for forming rod bushings, by H. C. Gillespie 94*

Tools for turning and threading small screws, by W. S. Anderson 211*

Truck, Mounted wheel, Union Tank Line Co. 44*

Tube cutter, Portable, by W. S. Whitford 268*

Tube expanders, Method of making, Sno Line 98*

Turnout bolt, and a bar cutter, by Arthur J. Humphrey 93*

Vaporizer for burning kerosene, Illinois Central 263*

Shop lighting, Modern railway 207*

Shop puts, Air hose connection for, by R. L. Preston 268*

Shop regiments, The railway 376*

Shop schedule, The value of 475

Shop, Steel car, E. J. & E. 563*

Shop tools, Developments in railway 297

Shops, Electrical equipment repair 203*

Shops, Machine tool equipment in railway 43

Shops, Routing work in railroad 228

Shops, Transporting material in 428

Shops, Women workers in railroad 702*

Shrinkage, Assisting, in autogenous welding by mechanical means, by E. S. Norton 263*

Shukaloff drifting valve 549*

Side bearing location, by L. K. Silcox 445

Side bearing, A self-centering roller, Wine Railway Appliance Co. 51*

Side rods, Reversible eccentric and 105*

Silcox, L. K., Air brake lever computations 345*

Silcox, L. K., Freight car repair problems 137*

Silcox, L. K., Handling freight car maintenance 569*

Silcox, L. K., Reinforcing freight car draft sills 195*

Silcox, L. K., Side bearing location 445

Simplex Safety Boiler Gage Glass Co., Water gage glass guard 462*

Slack action in long passenger trains (Air Brake Assoc.) 389

Slack adjuster, Truck lever type for freight cars, Gould Coupler Co. 600*

Slackers in the repair forces 610

Slicer, Hiram J., Graphic display of individual daily fuel records (Fuel Assoc.) 383*

Smoke Prevention Assoc., Firing engines at engine houses 242

Smoke, Prevention of locomotive, by J. T. Anthony 621*

Snow plow, A pilot, by C. C. Leach 66*

Soldiers, Chemical heater for 674†

South African Railways, Gap riveter for steel cars 588*

Southern Railway, Duplex locomotives 121*

Southern Railway, New power for 381*

Spicer, H. C., Reducing wear in driving box cellar bolt holes 258*

Spidy, E. T., A furnace for case-hardening with cyanide 91*

Spidy, E. T., Increasing output and reducing unit costs 315*

Springs, Design of heavy helical, by G. S. Chiles and R. G. Kelley 477*

Springs, Service tests of steel, by George T. Glover 124*

Standardization and improved locomotive service, by Geo. Armstrong 541

Standards, Keeping, up-to-date 117

Standards, The safety appliance, by Hiram W. Belnap 393*

Starrett Co., L. S., Hack saw machine 48*

Starter for induction motors, Automatic, Electric Controller & Mfg. Co. 653*

Statistics of steel passenger train equipment 386

Stahlbolck chuck, A handy 452*

Stahlbolck, Flexible, American Flexible Stahlbolck Co. 353*

Steam pipe joint rings, Chicago Great Western 9*

Steam pipes, Making, by ox-welding methods, by W. H. Hauser 154*

Steel for cars and locomotives 487†

Steel casting, Flawless and homogeneous 406†

Steel, High speed, tipped tools, by M. C. Schaphorst 643*

Steel imports, British 444†

Steel for locomotive fireboxes, Mild 273†

Step, Extension coach, D. M. & N. 163*

"Stickers," Making, by Harvey DeWitt Wolcomb 206

Stock, Walter, A rod and drawbar upsetting machine 45*

Stoker, Duplex locomotive, Locomotive Stoker Co. 408*

Stresses on end framing of cars, by H. J. Hemmessey 582

Strainer, Air pump, Canadian Northern 132*

Strainer, Air pump, Gustin-Bacon Mfg. Co. 48*

Strainer, Air pump, N. T. Chne 515*

Strainer brasses, Locomotive 212*

Studs, Tool for removing broken, Cleveland Twist Drill Co. 161*

Stuffing boxes, Reclaiming air compressor, by C. W. Schane 212*

Stull, Howard W., Pneumatic bolt clamp 35*

Submarine, First 579†

Superheat in power plant work 120†

Superheater flues, steam hammer dies for swedging 640*

Superheater flues, Tools for cutting holes for, by M. K. Saw 156*

Supervision, Increase (engine terminal competition article) 69†

Supervision, Notes on roundhouse, by John F. Long 9†

Supplies, Railway, and foreign markets 38

Supply Trade Notes

Acar Mfg. Co. 526, 607

Ackerman, A. H. 225

Acme Supply Co. 280

Ajax Forge Co. 471

Ajax Mfg. Co. 716

Mford, Leon P. 222, 279

Allegheny Steel Tank Car Co. 57

Allen, Harry L. 607

Allen, S. G. 717

American Arch Co. 114*, 280*, 418, 526, 719

*Illustrated article; †editorial; ‡short non-illustrated article or note; ††competition.

Supply Trade Notes—(Continued)

American Brake Shoe & Foundry Co. 232
 American Car & Foundry Co. 527
 American Car Foundry Co. 169
 American Car Foundry Co. 58, 114,
 115*, 116, 169, 365, 416, 470, 527, 719
 American Malleables Co. 56
 American Malleables Co. 222
 American Manganese Steel Co. 470
 American Steel Export Co. 168, 470
 American Steel Foundries. 168, 526, 607
 Arms, Robert L. 223
 Armstrong, H. T. 114
 Austin, W. A. 58
 Automatic Screw Machine Products Co. 416
 Automatic Straight Air Brake Co. 472, 608
 Bacon, J. L. 213
 Baetz, H. F. 169
 Bailey, William M. 719
 Baldwin Locomotive Works. 608, 660, 718*, 719
 Ball, H. F. 660
 Barany, Edmund 113
 Barco Brass & Joint Co. 113
 Barco Mfg. Co. 660
 Pardwell, H. F. 57, 168
 Barrett Co. 365
 Barry, John G. 114
 Bart, W. C. 365
 Bechtel, B. T. 471
 Bee, W. G. 113
 Bender, George W. 417
 Bennett, Frederick S. 168
 Bentley, Walter H. 660
 Berdan, William 419
 Berry Bros. & Co. 417
 Berry, Thomas 716
 Rettendorf Co. 56
 Betton, J. M. 280
 Bigler, Jr., H. F. 660
 Blagden, A. S. 115
 Blanchard, Frederick C. 417
 Blevney Maine Co. 279
 Blunt, J. G. 660
 Bock, Karl W. 56
 Borrowsdale, J. M. 660
 Boss Nut Co. 56
 Bostwick-Lyon Bronze Co. 168
 Boyle, A. J. 660
 Bradford, A. C. 279, 608
 Bradford Ackermann Corp. 114
 Bradford Draft Gear Co. 281
 Bradley, Frank B. 416
 Brady, James B. 223, 365, 719
 Brown & Co., Inc. 470
 Browne, R. L. 365
 Bruce, A. D. 279
 Brunswick, O. 417
 Burns, B. John 366
 Buffalo Brake Beam Co. 222
 Bullard Machine Tool Co. 419
 Burdett Oxygen Co. 719
 Burgert, Garrett 58
 Burkholder, C. J. 57
 Burns, Steel Co. 417
 Butler, E. W. 661
 Byers, John A. M. 117
 Byrne, J. J. 57, 470
 Camel Co. 57
 Cameron, L. O. 57
 Canadian Car & Foundry Co. 168
 Canadian Westinghouse Co., Ltd. 417
 Capps, O. 607
 Caryl, Edward F. 718
 Carscadin, Charles A. 418
 Cary, Walter 419
 Castle, C. C. 116
 Chamberlain, Harold B. 171
 Chicago Car Heating & Equipment Co. 57
 Chicago Railway Equipment Co. 470
 Cincinnati Equipment Co. 417
 Clark, Charles S. 718
 Clark, W. G. 417
 Clarke, W. V. V. 716
 Clement, Don L. 419
 Cleveland Milling Machine Works Co. 417
 Cleveland Punch & Shear Co. 660
 Cleveland Railway Drill Co. 56
 Coffey, Ralph G. 718
 Coffin, C. W. F. 169
 Coffin, J. S. 365
 Cohen, L. L. 417
 Coleman Railway Supply Co. 716
 Columbia Steel & Shafting Co. 170, 222, 716
 Combustion Engineering Corp. 660
 Continental Construction Corp. 526
 Cooper, F. R. 365, 470
 Cooner, G. A. 417
 Corbin Screw Co. 718
 Conklin, Jack 608
 Coyle, W. H. 57
 Crane Packing Co. 660
 Creer, H. W. 113, 114, 472, 608
 Cross, C. W. 417
 Crucible Steel Co. 113, 114, 472, 608
 Dakin Emergency Safety Brake Co. 222
 Dale, Russell 113
 Darrow, W. W. 608
 Davis, Frank W. 169
 Davis, Joseph 168
 Dayton M. Co. 471
 Deering, Herbert 366
 Detrick, I. W. 222
 De Laval Steam Turbine Co. 280
 Detroit Lubricator Co. 222
 Dewey, Luman R. 222
 Dillon, E. P. 222

Supply Trade Notes—(Continued)

Dix, John W. 365
 Dodd, W. C. 222
 Dodge Mfg. Co. 225
 Dodge Mfg. Co. 470
 Doran & Co., H. G. 417, 470
 Doug, Willard 365
 Dowler, Forbes & Co. 365
 Dressler, L. R. 719
 Dunbar Mfg. Co. 365
 Dunbar, Sr., Thomas 280
 Duncan Lumber Co. 56
 Dunham, F. C. 224
 Dunham, W. G. 608
 Dunham, W. C. 660
 Dunn, Morrill 661
 DuPont de Nemours & Co., E. I. 57, 223
 Economy Devices Corporation. 57, 223
 Edgewater Steel Co. 57
 Edison, H. P. 716
 Edison Storage Battery Co. 471, 660
 Edison Storage Battery Supply Co. 470
 Eib, Charles H. 168
 Eklund, K. J. 279
 Ekman, J. B. 365
 Evans, Harry M. 56, 718
 Falls Hollow Staybolt Co. 660
 Fisher, Edward C. 56
 Fisk, George C. 279
 Fletcher, Andrew 58
 Flint & Chester, Inc. 526
 Flint, N. B. 57
 Franklin Railway Supply Co. 56, 365
 Franklin Railway Supply Co., Inc. 717
 Fraser, Roland C. 470
 Galena Signal Oil Co. 224
 Garland, Thomas H. 526, 608
 Garland, Thomas H. 416
 Garold, Elmer H. 279
 General Electric Co. 171, 365, 416
 General Roofing Mfg. Co. 170
 Gentry, Thomas W. 169
 Glazier Mfg. Co. 719
 Goethals, General George W. 526
 Gold Car Heating & Lighting Co. 719
 Goldschmidt Plumb Co. 279
 Goodrich Co., E. F. 279
 Goodrich Rubber Co., B. F. 716
 Goodwin Car Co. 365
 Goodyear Lumber Co., C. A. 526
 Gordon, F. L. 366
 Gordon, Robert L. 171
 Goss, W. R. 114, 527, 608
 Gould Coupler Co. 716
 Graver Tank Works, Wm. 417
 Graves, Ralph E. 417
 Gray, H. A. 68
 Green, H. M. 169
 Grieves, Edward W. 222, 281
 Grigg, Frank 58
 Groce, George H. 168
 Groce-Henderson Co. 417
 Hall, W. W. 717
 Hamilton, I. F. 114
 Hannum, Ellis J. 222
 Hansen, J. N. 222, 223, 281
 Harlan & Hollingsworth Corp. 223
 Harrison Bros. & Co., Inc. 660
 Harris, John 607
 Haskell & Parker Car Co. 114, 607
 Hassman, L. E. 223
 Hatch, M. C. M. 171
 Hawks, E. A. 526
 Hazard Mfg. Co. 168
 Hazellhurst, A. 526
 Hefflinger, A. E. 224
 Hefflinger, H. A. 224
 Hegeman, B. A., Jr. 418
 Herr, H. T. 114
 Hess-Bright Mfg. Co. 168
 Hiland, Fred S. 171
 Hill, George H. 224
 Hillman, E. D. 57
 Johnson, F. G. 168
 Hoffman, H. A. 57
 Helden & White 57
 Jolland, Cyrus J. 168
 Hooper, Blake C. 223
 Hough, Jesse 526
 Hughes, Col. Herbert 57
 Hughes, Arthur 115
 Humphrey, Robert L. 279
 Hunt & Co., Robert W. 169
 Hunt, Harry B. 527
 Huntley, F. P. 608
 Hunt-Spiller Mfg. Corp. 225, 279
 Hydraulic Press Mfg. Co. 416
 Illinois Steel 365
 Independent Pneumatic Tool Co. 222, 527
 Ingersoll-Rand Co. 527
 International Oxygen Co. 527
 Interstate Iron & Steel Co. 116
 Jackman, Edwin T. 526
 Jackson, J. L. 56
 Jenks, Alfred Blunt 661
 Jerome-Edwards Metallic Packing Co. 223
 Johns-Manville Co., H. W. 222, 279, 472
 Joliet Railway Supply Co. 366, 719
 Joyce, Adrian D. 526
 Keith Railway Equipment Co. 279, 660
 Kellner, J. W. 281
 Kelly, W. E. 168
 Kennedy, E. 607
 Kenyoke Railway Equipment Co. 168
 Kilburn, F. D. 223
 King, Arthur 222

Supply Trade Notes—(Continued)

Kling, P. M. 526
 Lacomia Car Co. 470, 526
 Lagoda Mfg. Co. 168
 Lake Erie Iron Co. 608
 Lane, Wm. T. 719
 Lansing Co. 56, 114
 Larsen, Lewis A. 719
 Lassiter, Columbus K. 280
 Layfield, E. N. 222
 Leighton, William 59
 Leighty, W. T. 526
 Lewis, Arthur S. 526
 Lincoln Electric Co. 417
 Lincoln, Ike W. 56
 Lindenkohl, Henry 116
 Lipman Refrigerator Car & Mfg. Co. 168
 Litchfield, Thomas E. 172
 Locomotive Pulverized Fuel Co. 417
 Locomotive Specialty Co. 417
 Locomotive Stoker Co. 417, 661
 Locomotive Superheater Co. 279
 Lodge & Shipley Machine Tool Co. 366, 470
 Loudon, A. C. 279
 Louisville Car & Foundry Co. 223
 Lourel, Cyrus H. 365
 Luscombe, J. T. 169
 McAlpine, Alexander R. 114
 McBride, Walter J. 607
 McArthur Drill & Tool Corporation. 419
 McConnell, David H. 717
 McCord & Co. 365, 526, 608, 660, 716, 717
 McCormick, Charles H. 225
 McGraw-Hill Publishing Co., Inc. 115
 McGraw Publishing Co. 365
 McHinn, H. B. 222
 McNaughton, James 607
 Macleod Co. 416
 Mahr Mfg. Co. 607
 Manning, Maxwell & Moore 222
 Marburg Bros., Inc. 222
 Mark, F. Lloyd 281, 365, 470
 Mark Mfg. Co. 280
 Marsh Refrigerator Service Co. 114
 Marshall, Waldo H. 168
 Matthews, H. A. 416
 Meaden, J. A. 279
 Means, W. A. 113
 Mellor, C. L. 419
 Mesker, L. H. 222
 Meyers, M. B. 222
 Middletown Car Co. 279
 Milkesell, H. S. 113, 281
 Miller, Leslie W. 716
 Miller, Allen R. 280
 Milwaukee Refrigerator Transit & Car Co. 168
 Modern Tool Co. 56
 Moore, Charles B. 222
 Mott Sand Blast Mfg. Co., Inc. 471
 Mudge & Co. 58, 471
 Mudge, Burton W. 57
 Murgan, D. B. 470
 Mull, Howard C. 526
 Munro, David A. 471
 Myler, Paul Indson. 168, 223
 National Car Equipment Co. 719
 National Lock Washer Co. 222, 223, 526, 660
 National Malleable Castings Co. 416
 National Railway Appliance Co. 170, 224, 417, 607, 717
 National Railway Devices Co. 57
 National Steel Car Co. 526
 National Tube Co. 57
 Naylor, Norman 418
 Newman, C. A. 114
 Newton Machine Tool Works, Inc. 471
 Nicholson, Samuel L. 224
 Niles-Bement-Pond Co. 58
 Northwestern Malleable Iron Co. 279
 Oatley, Henry B. 365
 Okonite Co. 661
 Oshy, Oscar F. 222, 608
 Oxford Railroad Service Co. 59, 222, 608
 Oxy-Acetylene Appliance Co. 660
 P. & M. Co. 660
 Pacific Car & Foundry Co. 660
 Paige & Jones Chemical Co. 229
 Parker, H. McB. 417
 Parkers, Robert C. 168, 526
 Paxton-Pair Co. 365
 Paxton-Mitchell Co. 58
 Peabody, G. H. 56, 716
 Perolin Railway Service Co. 281
 Pew, John O. 225
 Pilliod Co. 56
 Platt, J. G. 58
 Pollock, Edward L. 58
 Pollock, George L. 366
 Pomeroy, L. R. 170, 716
 Pratt & Lambert, Inc. 660
 Preston, Fred A. 279
 Pullman Co. 57
 Purdy, F. W. 419
 Purdy, D. W. 279
 Pyle-National Co. 222, 365
 O & C Co. 366
 Quest, Harry C. 660
 Radford, Robert 280
 Railway Car Manufacturers' Assn. 171, 416
 Railway Motor Co. 526
 Railway Specialties Corp. 471, 526
 Railway Steel Spring Co. 57
 Ramsey, Charles C. 113

*Illustrated article; †editorial; ‡short non-illustrated article or note; †communication.

Supply Trade Notes—(Continued)

Randolph, J. L. 57*
 Reading Specialties Co. 718*
 Reed, Fayette H. 660
 Reed, Frederick E. 225
 Reed-Prentice Co. 225
 Replogle, J. Leonard. 224
 Republic Iron & Steel Co. 168, 366
 Rhoads, C. H. 416
 Richey, E. 170
 Ridgeway-Quest. Co. 366
 Ristine, John D. 36
 Roberts & Schaefer Co. 660
 Robinson, Alexander P. 222
 Robinson Paint Co. 607
 Rodney, Keith R. 366
 Rome Merchant Iron Mill. 279
 Ross Power Equipment Co. 417
 Ross, William H. 363
 Ruby, E. L. 323*
 Rugg, W. S. 417
 Ryan Car Co. 169, 417
 Ryerson & Son, Joseph T. 171*
 Safety Car Heating & Lighting Co. 114
 Sanitary, F. N. 608
 Savage, H. D. 114*
 Sawyer, James D. 470
 Schaefer Equipment Co. 470
 Schlacks, W. J. 717*
 Schoen, Charles T. 170
 Scott, George E. 607
 Sebastian, Don B. 279
 Sellers Mfg. Co. 365
 Sherritt & Stoev Co., Inc. 223, 516
 Sherwin-Williams Co. 717
 Shields, S. S. 322
 Shute, H. D. 418*
 Sinkler, Joseph 716*
 Skelton, F. A. 57
 S. K. F. Ball Bearing Co. 57, 366
 S. Rawson, James H. 416*
 Slaybaugh, Harvey B. 280*
 Southern Locomotive Valve Gear Co. 323*
 Southwark Foundry & Machine Co. 323*
 Spieth, W. S. 526
 Sprague, I. C. 472
 Stafford, Hal R. 719
 Standard Forgings Co. 170
 Standard Railway Equipment Co. 717
 Standard Steel Car Co. 281*
 Stebbins, Albert Clark 56, 114*
 Stebbins, S. C. 470
 Steel & Iron Mongers, Inc. 416
 Steel Car Co. 366, 416
 Steele, W. P. 471
 Stillwell Engineering Corp., L. P. 417
 Street, Clement F. 223
 Stromberg Motor Devices Co. 661
 Sullivan, Arthur C. 57
 Taylor, Howard D. 526
 Taylor, R. G. 716
 Taylor, S. B. 57
 Thomas, D. C. 168
 Thompson, Wm. T. 223
 Titanium Alloy Mfg. Co. 223
 Titanium Bronze Co. 608
 Toppan, Wm. C. 418
 Trapp, Charles H. 419*
 Tuco Products Corp. 609
 Turville, George A. 608
 Tyden, Emil 169
 Union Supply Co. 58, 115*
 Union Switch & Signal Co. 58, 115*
 United Hammer Co. 59
 United States Graphite Co. 365, 57
 United States Light & Heat Corp. 58, 168, 223, 225
 United States Metallic Packing Co. 169
 Vanadium-Alloys Steel Co. 225, 660, 716
 Van Houten, Richard A. 365
 Van Sweringen, F. H. 365
 Vapor Car Heating Co., Inc. 280, 416, 470
 Varney, H. A. 222*
 Verona Tool Works 526
 Vought, Charles S. 417
 Wadsworth-Holland Co. 168
 Waldron, H. A. 223
 Walsh, W. F. 471
 Wardworth Mfg. Co. 717
 Ward Leonard Electric Co. 660
 Wason Mfg. Co. 279
 Wassell, F. L. 417*
 Wegman, Ernest H. 223
 West Distilling Co. 223
 Western Electric Co. 57
 Westinghouse Air Brake Co. 57, 58
 Westinghouse Electric & Mfg. Co. 170, 223*, 225, 418*, 471*, 660
 Weymouth, F. M. 225*
 Wharton, Oden H. 472
 Wharton Steel Co. 113, 225
 White, C. E. 223
 Whitman, Daniel A. 470
 Wimey, Horace M. 171*
 Wiley & Sons, John 607
 Williams, Charles H. 56
 Williams, Charles P. 223
 Wilson, Hugh M. 115*
 Winey, C. L. 718*
 Wood, W. H. 222
 Woods, John E. 607
 Woodworth, Carl B. 418
 Wright, W. V. D. 57
 Yardley, Charles B. 470
 Young Mfg. Co., R. W. 58*

Supply Trade Notes—(Continued)

Youngstown Steel Car Co. 719
 Zelmick Supply Co., Walter A. 417, 418, 470, 527, 211*
 Support for pyrometer, Spring, by M. K. Swali holder, Rod packing and, Faxton-Mitchell Co. 217*
 Swanson Automatic Flange Lubricator Co., Automatic flange lubricator. 218*
 Swezey, Perry L., Holder-on with automatic recoil 264*

T

Tap, A collapsing, National Acme Mfg. Co. 104*
 Tapper (see Machine tools).
 Taylor, C. S., Hot box competition article. 254
 Tempering blast, Shield for, Chicago & North Western 695*
 Tender design, An innovation in, Rock Island 673*
 Tender trucks, Articulated, Economy Devices Corporation 216*
 Terminal (see also Engine terminal).
 Terminals, Handling locomotives at. 474§
 Tester, Superheater unit, C. B. L. & P. 153*
 Testing department, A neglected function of the 62§
 Testing freight car brakes in yards, Appliances for, by M. K. 148*
 Testing machine, Boiler tube, Watson-Stullman Co. 214*
 Testing machine, Hose by F. Osborne. 514*
 Tests, Firebox temperature, Practical, by G. S. Evans. 19*
 Tests, Locomotive brick arch. 228§
 Tests of machine tools, Power, by C. H. Crawford 294*
 Tests, Mikado type locomotive, Penn. R. R. 328*
 Tests of Moore heater car. 710
 Tests of a Pennsylvania Atlantic type locomotive, by Andrew C. Loudon. 177*
 Tests, Pennsylvania Railroad locomotive brick arch 235*
 Tests of steel springs, Service, by George T. Glover 124*
 Thermostatic metal, General Electric Co. 516*
 Thomas Grate Bar Co., Elliptical grate bar. 270*
 Thread lead indicator, Bucknell-Thomas Co. 463*
 Tinware, Saving money on railroad, Great Northern 511*
 Tip, Special, for cutting rivet heads by oxy-acetylene process, Prest-O-Lite Co. 464*
 Tobacco fund, Railway regiments'. 616
 Tobesura Weno "Back on the job" 424*
 Tobesura Weno "In the mat" 176†
 Tobesura Weno "Too sharp for the m.m." 534†
 Tool for finishing piston rods, roller, by A. I. Humphrey. 148*
 Tool for forming rod bushings, by H. C. Gillespie 94*
 Tool holders, Armstrong Bros Tool Co. 352*
 Tool for removing broken studs, Cleveland Twist Drill Co. 161*
 Tools for cutting holes for superheater flues, by M. K. 156*
 Tools, Developments in railway shop. 450*
 Tools, Hand, and safety first. 450*
 Tools, High speed steel tipped, by M. C. Whelan 643*
 Tools for turning and threading small screws, by W. S. Anderson. 211*
 Tools for the workmen, by W. G. London. 424†
 Tractive effort formula, The Kiesel, by Lawford H. Fry. 69, 126
 Tractive effort formulas, Locomotive. 62§
 Train line maintenance, by A. McGowan. 189
 Train loading, Mechanical department a factor in, by T. T. Ryan. 624
 Train pipe connector, Union automatic. 105*
 Trains, Handling heavy, on grades (Air Brake Assoc.) 385
 Trains, Rough handling of passenger. 117§
 Trainagraph, American Steam Gage & Valve Mfg. Co. 650*
 Training, Car inspectors need better. 63§
 Trainmen, A protest—educate the, by R. J. Quintrell 612†
 Trainmen, Educate the, by A. W. Norton. 666†
 Transfer of loads, Unnecessary, by Wm. Hansen 534†
 Transportation of material in shops. 42§
 Trap door lock, Vestibule, Tuco Products Corporation 461*
 Traveling Engineers' Association, A word from 616
 Truck bolster, Huntton, Joliet Ry. Supply Co. 601*
 Truck, Mounted wheel, Union Tank Line Co. 44*
 Truck for Norton jack, by C. W. Schane. 134*
 Truck, Pennsylvania refrigerator cars. 212*
 Truck wheel grinder, Portable, by F. Osbourne 501*
 Truck, 6-wheel for Virginian 120-ton coal car, Buckeye Steel Castings Co. 216*
 Trucks, Articulated tender, Economy Devices Corporation 268*
 Tube boring and facing machine (see Machine tools).
 Tube cutter, Portable, by W. S. Whitford. 98*
 Tube expanders, Method of making, by F. W. Seelert 125*
 Tube sheets, Load distribution around the dry pipe opening in, by T. H. Walker. 47*

Tube sheets, Repairing cracks in the 158
 Tubes, A use for old, by "Apex" 36
 Tubes (see also Boiler tubes).
 Tuco Products Corporation, Insulation for passenger car floors. 464*
 Tuco Products Corporation, Vestibule trap door lock 461*
 Turner, Walter V., Passenger car foundation brake rigging. 199*
 Twist, George, Rod job competition article. 513*

U

Underframe, Steel, for wood freight cars, D. & H. 683*
 Union Automatic Connector Corp., Automatic train pipe connector. 105*
 Union Tank Line Co., Mounted wheel truck United States Graphite Co., Automatic dry graphite cylinder lubricator. 270*
 Upsetting machine, A rod and drawbar, Walter Stock 45*

V

Valuation committee, Midwestern mechanical 126
 Valuation, Keeping the, up-to-date. 423‡
 Valuation in the mechanical department. 61§
 Valuation organization, Mechanical department 283§
 Valuation of rolling stock, The. 175‡
 Valuation work, Co-operation in. 118§
 Valve boiler tubes, R. B., Applying locomotive 149
 Valve facing machine, Air 211*
 Valve gear design, Walschaert, by H. A. Weiss 71*
 Valve packing rings, piston, Chuck for finishing 407*
 Valve, Piston, Russian Decapod locomotives 548*
 Valve, Shukaloff, drifting valve. 549*
 Valve, Zybloff, by-pass. 549*
 Valves, Method of testing air pump and steam heat governors, etc., by J. A. Jesson 644*
 Vaporizer for burning kerosene, by Charles N. Coons 263*
 Ventilating shutter, Car, Wine Railway Appliance Co. 45*
 Virginian Railway, 120-ton coal car. 493*
 Virginian Railway, Triplex locomotive (with inset) 64*
 Virginian Railway, 6-wheel truck for 120-ton coal car. 501*
 Vice, A handy pipe, Whittington-Vaughn Co. 356*
 Vulcan Engineering Sales Co., Hanna pneumatic riveting machine. 217*

W

Wabash Railway, 2-10-2 type locomotive. 667*
 Waldron, H. S., Gages for determining the lift of air pump inlet and discharge valves. 322*
 Walker, Locko, Rig for planing outside of crosshead shoes 648*
 Walker, Thomas H., Load distribution around the dry pipe opening of front tube sheets 125*
 Walton, H. S., Maintenance of air brakes on freight cars. 145
 Wanamaker, E., Electric arc welding. 593
 Wanamaker, E., Electric welding instructions 644
 Wanamaker, E., Electric welding on the Rock Island 307*
 War, A big job ahead. 529§
 War Board, Support the Railroads'. 368§
 War conditions, "Do your bit" 287§
 War conditions, Readjustment to present. 229§
 War, The duty of the men at home. 664§
 War, Everyone can help win the. 438*
 War locomotive, United States Army. 473§
 War, The mechanical department and the. 611§
 War, The performance of cars and locomotives 238*
 War, Prompt action by the railways in the. 227§
 War, The railways and the. 489
 War, Purifying shop drinking, by W. S. Whitford 543*
 Wilford, Railway efficiency and the, by Daniel 568†
 War, Railway engineers' now in France. 616
 War, Railway shop employees' part in. 616
 Waste check, Journal box, Ideal Waste Check Co. 462*
 Water cage glass guard, Simplex Safety Boiler Gage Glass Co. 202*
 Water, Purifying shop drinking, by W. S. Whitford 214*
 Watson-Stillman Co., Boiler tube testing machine 650*
 Watson-Stillman Co., Portable crank pin press 202
 Watts, N. L., Association competition article 258*
 Wear in driving box cellar bolt holes, Rectified, by H. C. Spicer 629*
 Weaver, C. R., Train brake leakage determinations 651*
 Weigel Machine Tool Co., Drilling machine with tapping attachment. 71
 Weiss, H. A., Walschaert valve gear design 47*
 Welder, Arc, Wilson Welder & Metals Co. 47*

*Illustrated article; †editorial; ‡short non-illustrated article or note; §communication.

Welding a cracked cylinder, by Joseph Schneberger	322	Westbrook, M. H., Milling jaws in side rods	476†	Wolcomb, Harvey De Witt, And then the worm turned	456
Welding, Electric arc, by E. Wanamaker	593*	Weston, A. H., Fallacies regarding malleable iron	481*	Wolcomb, Harvey De Witt, "Cleaning up" Monette roundhouse	265
Welding, The electric, process (Railway Electrical Engineers' Assoc.)	41	Wheel, The chilled iron car, by George W. Lydon	249*	Wolcomb, Harvey De Witt, "Fired"—For the good of the service	37
Welding high-speed steel tips to tools, by J. G. Fraser	158	Wheels, Machining car axles and	453	Wolcomb, Harvey De Witt, A foreman who fired himself	99
Welding, Information on arc, by F. G. De Saussure	95*	Wheels, Reclaiming cast iron	406	Wolcomb, Harvey De Witt, Making "Stickers"	206
Welding information, Some arc, by F. G. De Saussure	156*	Whelan, M. C., High speed steel tipped tools	643*	Wolcomb, Harvey De Witt, Milling machines in railroad shops	321
Welding instructions, Electric, by E. Wanamaker	644	Whelan, M. C., Tools for making locomotive safety chains	35*	Women workers in England	438†
Welding, Assisting shrinkage in autogenous, by mechanical means, by E. S. Norton	263*	Whistle, Origin of the locomotive steam	38†	Women workers in railroad shops	474‡, 702*
Welding, Mixture of acetylene and oxygen for	210†	Whitford, W. S., Portable flue cutter	268*	Woodworking lathes, Motor headstocks for	651
Welding, Oxy-acetylene	248†	Whitford, W. S., Purifying shop drinking water	202*	Westinghouse Elect. & Mfg. Co.	651
Welding, Oxy-acetylene, Making steam pipes by, by W. H. Hauser	154*	Whittington-Vaughn Co., A handy pipe vise	356*	Work distribution in the roundhouse, by John F. Long	262
Welding, Some oxy-acetylene repairs	591*	Willard, Daniel, Railway efficiency and the war	489	Work reports, Do not slight the	610‡
Welding on the Rock Island, Electric, by E. Wanamaker	307*	Williams, Thos. R., Calculating height of grain line for box cars	636		
Welding system, Constant current, closed circuit arc, Arc Welding Machine Co.	161*	Wilson Welder & Metals Co., Wilson arc welder	47*	Y	
Welds for steam boilers, Autogenous	44†	Windows, Clear vision cab, by J. H. Nagle	649*	Yards, Arrangement of car repair	610‡
Western Maryland, A dining car water heater	24*	Wine Railway Appliance Co., Car ventilating shutter	45	Year books, Mechanical association	421‡
Westinghouse Air Brake Co., Westinghouse "Fifty-four" air strainer	272*	Wine Railway Appliance Co., A self-centering roller side bearing	51*	Year, Change in fiscal	1‡
Westinghouse Electric & Manufacturing Co., Motor headstocks for wood-working lathes	651	Winterrowd, W. H., Locomotive design from a maintenance standpoint	678	Y. M. C. A., The railroad	530‡
		Wisconsin Electric Co., Type "C" Dumore grinder	355*	Z	
				Zyabloff by-pass valve	549*

*Illustrated article; †editorial; ‡short non-illustrated article or note; †communication.

Railway Mechanical Engineer

Volume 91

January, 1917

No. 1

Change in Fiscal Year

The action of the Interstate Commerce Commission in changing the fiscal year of the railways to end on December 31 instead of June 30 will be warmly appreciated by many mechanical department officers. The time to repair locomotives and cars is when business is light and there is a surplus of equipment in the spring and early summer. While the stronger roads are able to do this the mechanical departments on many roads have been handicapped by the restrictions on expenditures for the repair of equipment during the period of slack business in the spring in order to make an artificially good showing for the current year. As business begins to increase after July 1 it becomes necessary to rush equipment into service with the minimum amount of repairs, resulting in failures on the road and consequent delay.

Higher Postage Proposed for Magazines

Newspapers and magazines are now carried by the postoffice at the rate of 1 cent a lb. The Randall rider to the postoffice bill proposes to change this to 1 cent a lb. for distances up to 300 mi.; 2 cents a lb. for from 300 to 600 mi.; 3 cents a lb. from 600 to 1,000 mi.; 4 cents a lb. from 1,000 to 1,400 mi.; 5 cents a lb. from 1,400 to 1,800 mi., and 6 cents a lb. over 1,800 mi. Obviously the effect of this will be to restrict the circulation of our national magazines, thus defeating one of the fundamental purposes for the establishment of the postoffice—the better education of citizens throughout the length and breadth of the land, and the development of a spirit of patriotism and national unity. Then, too, the method of charging by zones and in almost direct proportion to the mileage is not at all just. Investigations have shown that the greater part of the cost of handling mail is at the terminals and that the relative cost of transporting it from place to place is comparatively small. It hardly seems possible that a government that is as far-sighted and as liberal as our own in carrying on educational projects, will allow the passage of an act which will throttle and impair the usefulness of such important agencies as our national magazines and technical journals.

The Draft Gear Problem

In deciding on the draft gear arrangement for freight cars there are several items that must be taken into consideration. It is of primary importance that a good substantial gear be used in order that the greatest service may be obtained from it. The gear must be of sufficient capacity to properly protect the car. The car must also be of substantial construction to withstand the heavy shocks it is bound to receive in service. The question as to what capacity the draft gear shall be, and how strong the draft sill construction shall be is a matter that is open to discussion. The problem is somewhat one-sided in favor of the heavy sill construction, as, regardless of the capacity of the draft gear itself, its maintenance is usually neglected. This of necessity requires

a sufficiently heavy draft sill construction to absorb the shocks that should have been absorbed by the draft gear.

Theoretically, however, the light sill with the high capacity draft gear is the most economical plan to follow. This was quite definitely shown in the M. C. B. draft gear committee report presented at the last convention. With an increase of 60 per cent in cross sectional area of the draft sills there was only about 20 per cent permissible increase in load in the case of the spring gear, before the sills were stressed beyond their elastic limits, and the increase was only 8 per cent in the case of a friction gear. Comparing the two gears for the same sills it was found that the friction gear would absorb three times as much load as the spring gear before the sills were permanently distorted, and in the heavier sills it carried 2.6 times as much. It is therefore plain that if increased protection is desired the draft gear capacity should be considered first, and that the draft sill capacity should be considered from the standpoint of poor draft gear maintenance. Where the sills are called upon to absorb too much of a shock it not only subjects the superstructure of the car to excessive racking and ultimate damage, but it also is very liable to damage the lading.

Benefits from Convention Attendance

The prizes in the competition on the Benefits Derived from Convention Attendance have been awarded to F. P. Roesch, master mechanic of the El Paso & Southwestern at Douglas, Ariz.; R. R. Clarke, Pittsburgh, Pa., and C. E. Copp, foreman painter, Billerica shops, Boston & Maine, North Billerica, Mass. Other communications possessing considerable merit will be published.

One of the writers emphasizes the value of the conventions as a "mind tonic." The demands upon the transportation machine or any of its departments are so severe in these days that haphazard work cannot be tolerated. No officer or foreman can afford to get into a rut, but must keep a clear head and use it. Getting out and seeing what the other fellow is doing and what he is thinking about is the best recipe known for getting and keeping out of a rut. The narrow-minded, self-satisfied attitude on the part of some officers and foremen is responsible for much inefficiency and waste both of energy and material. The biggest gains in efficiency cannot always be accurately measured in detail but are to be found in the aggregate on the balance sheet. Because they are not clearly evident in the detail operations they are not fully comprehended by the average officer, although the real executive—the man of vision and foresight—finds little difficulty in recognizing them clearly. The inspiration received from a convention gives far greater returns in increased efficiency in the better use of energy and materials than does the knowledge gained of some new detailed method or device, the exact measure of which cannot be gaged and which may in itself more than repay the cost of attending the convention. It is unfortunate that because the larger and more important saving is less easily comprehended it is so often overlooked.

One of the writers reported a convention which he attended

for a trade paper and marvels at the good he gained from it. He was forced to study the convention. Every representative should be required to report back to his management the good things which he has gained from attendance at the convention, in meeting people outside the convention hall and in visiting the exhibits. While observations indicate that most of the members in attendance at the mechanical department conventions are fully alive to the opportunities and work hard to get the most out of the meetings, many might be spurred to greater efforts if formal reports were required; some who are not as fully awake to the opportunities might be awakened, and the reports themselves would beyond doubt prove the value of convention attendance.

Mechanical Department Prospects for 1917

With the excellent business of the past year many roads have available more extensive funds with which to make improvements in shops and equipment that have in the past been necessary, but which for the lack of sufficient capital have been deferred. The mechanical department budgets for the year are considerably larger than those prepared for 1916. Several railroads are planning shop extensions in order that the repair work may be more efficiently performed. Improved machine tools are being purchased and every means is being taken to meet the demands for cars and locomotives required by the heavy business. The high price of metals and the poor deliveries has caused many roads to pay greater attention to the scrap piles. Material that hitherto was not profitable to reclaim has been repaired and re-formed into serviceable material at a saving over the market price. Cars that hitherto have been scrapped will be rebuilt, steel draft sills and in many cases steel draft arms, together with high capacity draft gears being used to put them into condition for service. Much of the material reclaimed from scrap will be and is now being used in rebuilding. Many castings that were made of bronze are now being made of malleable iron and steel, and the welding of high speed steel to carbon steel shanks for machine tools has become a common practice. Some roads are taking this opportunity for improving the efficiency of their power by the application of superheaters and brick arches to those engines whose condition and life warrant the expenditure. The year bids fair to be a busy one for both the railway shops and the supply houses which furnish them material. Every effort should be made properly to organize the forces so that the work will be put through with despatch and at the least possible expense.

The New Headlight Rule

Mechanical department officers on multiple track roads with heavy traffic were, to say the least, shocked when the Interstate Commerce Commission issued a new order, the day after Christmas, which is only a little less severe in its requirements than the original order. Just why the commission took the course that it did is difficult to understand. To see a dark object as large as a man of average size standing erect at a distance of 800 ft. ahead and in front of a headlight in a clear atmosphere requires a real searchlight. Much testimony has been given to show the danger of operating such headlights, even though they may be dimmed in passing opposing trains, because of the danger of misreading signals. Surely those engineers who went to Washington to testify against the use of such lights at the risk of losing their insurance rights in the brotherhoods and of being ostracized by their fellows, must have had pretty strong convictions on the subject. How can the commission explain away the results of the many tests which have been made under expert supervision in recent years and which have demonstrated the danger of using the high-power lights?

Objections have been raised by the boiler inspection department that it was not practicable to develop an apparatus which would make it possible scientifically to measure the intensity of the light, and therefore the rather vague requirement noted above has been adopted. Just how are the government inspectors going to make these tests? And will they be checked in their results, or will they be the sole judges as to whether the headlights which they find in service meet the government's requirements?

It would be interesting to know exactly why the locomotive inspection bureau and the labor leaders have worked so closely together in the hearings before the Interstate Commerce Commission. It would be equally interesting to know why the brotherhood leaders have had to threaten the members of the brotherhood with expulsion and ostracism if they testified against the high-power headlight. The members of the Interstate Commerce Commission are overburdened with work and responsibility. Undoubtedly they are sincere in trying to do that which in their sight is most fair to the public and to the railroads. In ordering the high-power headlights into service, however, they are assuming a tremendous responsibility as to the welfare of employees and passengers on heavy traffic roads. It hardly seems possible that, if the individual members had had an opportunity to study the records of the recent hearings closely, they could have agreed upon this rule.

The Hot Box Competition

The three prizes in the hot box competition have been awarded to J. S. Breyer, master mechanic of the Southern Railway at Charleston, S. C.; A. M. Dow, foreman freight car repairs, El Paso & Southwestern, El Paso, Tex., and J. E. Helms, inspector, Atchison, Topcka & Santa Fe shops, Pueblo, Colo. A large number of letters were received in the competition looking at the problem from different viewpoints; taken as a whole they form a most comprehensive study of the hot box problem. At least a dozen of them have been selected for publication in this or subsequent issues.

There seems to be a disposition in many quarters to regard the hot box problem as one which is not capable of solution. The same thing was said concerning accidents, and yet the safety first movement, as it has gained greater and greater impetus, has greatly reduced injuries and fatalities by removing the causes. Many railway officers despaired of reducing the loss and damage to freight, and yet the educational campaigns which have been conducted during the past two or three years have made wonderful reductions in this item. Many instances are on record where the right kind of a man in charge of an educational campaign, reaching all those who had any interest in the matter, has resulted in wonderfully increased economy in use of fuel, large increases in car loading, and really marvelous increases in train loading. The hot box problem can be eliminated if the supervising officers will see that each man who has anything to do with those factors which are liable to cause hot boxes is fully educated as to exactly how the work should be done, and is then, with his fellows, filled with enthusiasm and inspired to do his part in bringing the trouble to an end.

It would almost seem that the journal box on a freight car has no friends, and is neglected and passed by as a thing unfit to associate with—an outcast. As long as this continues to be the case it is hopeless to expect better results. On the other hand, if the waste and inefficiency which is caused by lack of proper care is once realized, the right man or men are sure to be developed that have enough enthusiasm and executive ability to start and direct a campaign for better results. If this is done many railroad officers may be surprised at the fact that the amount of lubricant actually required will be even less than under present conditions. In other words, it is not more oil that

is required, but a greater co-operation and inspiration on the part of all interests in seeking the real heart of the trouble and eliminating those defects which cause the trouble.

Railway Supplies and Foreign Markets Two measures are pending in Congress that should receive the backing of those who are interested in the extension of our foreign trade—and this should include all of us, for upon it will depend much of the future general prosperity of our country. One of these measures is the appropriation to the Bureau of Foreign and Domestic Commerce of the Department of Commerce. A fair indication of the efforts of the bureau in extending our export business is the attention which it is giving to the single item of railway equipment. Frank Rhea, formerly with the Interstate Commerce Commission, Division of Valuation, is now in Australia, having recently left New Zealand. He expects later to study the markets for railway equipment in Japan, China, India and South Africa. The bureau also hopes to send an expert to study the ports and transportation facilities in Russia; another to investigate mineral resources in the Far East, and still another, if possible, to study the markets for railway equipment in Latin America. Critical investigations of this character are quite necessary if we are to secure the best results, and the work of the department should not be hampered, particularly at this time, by paring down the appropriation which the bureau has asked for and every cent of which will be needed to carry out its proposed program.

The second measure is the Webb bill. It is of vital importance that American industries co-operate in order to market their products in foreign lands and successfully meet the competition of foreign combinations, some of which are actively backed up by their governments. At present such action on the part of American concerns would be unlawful under the provisions of the Sherman act. The Webb bill provides that nothing in the present anti-trust laws shall be construed to render illegal an association entered into for the sole purpose of engaging in export trade and actually engaged solely in such trade, or an agreement made or act done in the course of export trade by such association, provided such association, agreement or act is not in restraint of trade within the United States. It provides also that no provision of the Clayton bill shall be construed to forbid the acquisition or ownership by any corporation of the whole or any part of the stock or other capital of any corporation organized solely for the purpose of engaging in export trade. No special interests are opposing this bill. Obviously, it should be made effective at the very earliest moment, and surely during the present session of Congress. The bill was amended in going through the House to guard against certain fancied abuses. While these amendments looked very innocent, it has since been found that they would entirely nullify the purpose of the bill and would place our country in a ridiculous position. The Senate Committee which has the bill in charge is apparently examining it closely from a legal standpoint in order to make it really effective, but the committee also has in charge the railroad bill and there is danger of the Webb bill being lost sight of in the heavy pressure of work to which this committee is being subjected.

The Standard Box Car In May, 1914, the American Railway Association, on the initiative of various members, pre-eminent among whom was E. P. Ripley, president of the Atchison, Topeka & Santa Fe, appointed a committee to work out designs for a standard box car. Mr. Ripley was made chairman of this committee, and the other members are President Smith of the New York Central, President Rea of the Pennsylvania, President Harrison of the Southern, Chairman Kruttschnitt of the Southern Pacific,

Chairman Elliott of the New Haven, and President Markham of the Illinois Central. A sub-committee, of which George L. Wall is chairman, was appointed, consisting of representatives of four of the prominent car building companies. This sub-committee has been enlarged recently to include mechanical representatives from several roads. The work of the sub-committee is beginning to take definite form. Three types of box cars have been decided upon, the double-sheathed car, the steel frame single-sheathed car and the all-steel car. The first type may be built for either 60,000 or 80,000 lb. capacity, the second for 80,000 lb. capacity, and the third for 80,000 or 100,000 lb. capacity, making five designs in all. Sample cars of each of the different types are soon to be built. Some are in process of construction.

With the progress thus made it seems certain that the railroads in this country are assured of a box car of standard construction and one that will give the shippers and the handling lines the service they have a right to expect. There are several reasons why a standard box car construction should be adopted. Interchanging the cars and sending them broadcast throughout the country practically amounts to pooling the equipment. As a practical matter, a freight car is anybody's car, and the M. C. B. rules are such that that "anybody" has got to keep that car in repair. With the large number of different cars in service on the railroads today each road is required to keep a large assortment of repair parts on hand with which to make repairs, or to hold the car out of service until the necessary parts are received from the car owner, or to make "wrong" repairs at its own expense and get the car back into service. With a standard car a much smaller amount of material would have to be carried in stock, thus permitting a substantial decrease in the capital invested in such parts. This is one of the strongest arguments used by the advocates for the standard car.

The adoption of a standard car will eliminate the weak, inferior car of cheap and poor construction which is low in first cost and expensive in maintenance, and which can never be depended upon to reach its destination in proper condition. The committee has given particular attention to the maintenance feature, and has attempted to provide a car of minimum weight that will give the greatest service with the lowest practical first cost. The matter of interchangeability of parts has also been given careful consideration.

The car builders will be benefited by the adoption of the standard car. They will be in a position to make the cars at a lower cost, in that with the standard parts their dies, templates and drawings can be standardized. The cars can be built and material purchased during times of depression and held in stock, thus enabling the builders to maintain a more uniform shop output and to purchase material at favorable prices. The workmen becoming familiar with the standard designs would be able to do their work with greater despatch and increase their productivity. All of this should tend to lower the price of the cars to the railroads and give them more than they now receive for their money.

In some details of this work the committee has sought to improve or provide designs of equal merit for the various detailed parts in car construction that are covered by existing patents. Where it has been found impossible to do this satisfactory royalty arrangements have been made with the owners of the patents. It has made use of the M. C. B. standards to a very large extent and has been especially liberal in permitting the use of alternates in various elements in the construction. For instance, the draft gear is only limited by the center sill dimensions, and any roof can be applied which will accommodate itself to the Z-bar side plate, which is a fixed standard. It is this permitted use of alternates, together with the five designs of cars, that

rather complicates the "repair parts" feature. The present M. C. B. interchange rules (Rule 16) require that in repairs to foreign cars "the work shall conform in detail to the original construction" with a few exceptions. This would necessitate, therefore, each road carrying in stock a large number of the alternates with which to make repairs, or to follow the present practice of holding the car for receipt of those parts from the owning road. This, of course, is not desirable, nor is it believed necessary, except possibly in some few cases. The fact that the committee has approved these alternates indicates they will serve their purpose equally as well as the standard parts, and that the safe operation of the car is in no way jeopardized by their use. This being the case why not permit the application of the A. R. A. Standards in repairs for those alternates which are used on the car? This would not affect the service of the car, would relieve the handling line of carrying such an excess of parts and would permit it to get the car back into service without delay.

The advisability of adopting a standard car has been questioned because, as has been argued, it will interfere with development and remove the incentive under which mechanical experts have worked in the past to introduce improvements in car construction. With a corps of experts in the form of a committee under either the American Railway Association or the Master Car Builders' Association all the suggestions for improvements presented by the different roads could be thoroughly studied and the best one chosen. Changes could be made at prescribed periods without causing any very material disturbance in the established standard. These various suggestions would be subjected to a more careful scrutiny and many of the fantastic ideas that now find their way into car construction would be eliminated, and all of the roads would receive the benefit of the best improvements.

After all, the standard car is an economic necessity. Our freight cars are no longer company cars. They are owned by individual roads, but the chances are they are used more by other roads. Cases have been reported where cars have been away from their home roads for two years or more. Such cars must be repaired, and it is essential that the roads that are required to repair them be given every opportunity to do so with despatch and with the least possible expense.

Machine Tool Equipment in Railway Shops

It is strange that with all the improvements and developments in machine tools the railways of this country pay so little attention to properly equipping their shops. E. W. Pratt, in his presidential address at the last Master Mechanics' convention, made a statement to the effect that as compared with the industrial plants some of the railway shops are 30 to 40 years behind the times in their machine tool equipment. The question naturally arises, Why are they not improved? The invariable reply will undoubtedly be that the mechanical department cannot get money for the proper expenditures. In other words, mechanical department officers attempt to shift the responsibility to their superiors. More than likely the trouble lies with the mechanical department men themselves. Do they make the proper arguments and can they show their superiors through careful analysis just how much can be saved and what a splendid investment it would be to bring the machine tool equipment up to the proper degree of efficiency. On the face of it this would not seem to be a very difficult thing to do.

In the year ending June 30, 1914, the railways spent over \$50,000,000 in wages to machinists alone, and less than \$12,000,000 for shop machinery and tools. A saving of 1 per cent in machinists' labor, which could be easily accomplished by more efficient tools, would amount to \$500,000. Figuring interest and depreciation on machine tools at 15 per cent,

this \$500,000 would take care of an investment of something over \$3,000,000. There is no question but what a great deal more than 1 per cent could be saved in machinists' wages with such an expenditure for better and more efficient machine tools.

Nor is it believed that proper attention is given by the railways to the purchase of machine tools. It is not a purchasing department problem, and it should not be left in its hands. That department should act only as an intermediary obtaining the prices on the machines required, and permitting the mechanical department to have the last say as to what machines shall be purchased. The growth and development in the machine tool industry has been such in the past few years that only those who are in close touch and are thoroughly familiar with the service performed by various tools are competent to determine which tool shall be purchased. The smallest tool should be as carefully selected as the largest one.

It is impossible to pick the proper tools blindly. The improvements and special features in all types of machines are such that they must be carefully chosen. Some machines of the same type are better adapted for railway work than others, and in order that the best purchase may be made a careful study should be made of the already extensive market. Some railways have a man in the mechanical department organization whose sole duty is to study the machine tool needs of the shop. It is his business to study the field and to recommend for purchase the tool he has found best adapted for the work in question. He is responsible to a large extent for the output of the thousands of men in the shop organization, and it is by his judgment and careful study that the repair work is efficiently done and that the shops are provided with machines which are reliable and suitable for the work on which they are used.

The machine tools are the basis upon which the efficient shop is founded. With over \$50,000,000 spent each year for machine tool operators the railways can well afford to make very careful investigations to see that these operators are provided with proper and efficient equipment. They can well afford to pay competent men to follow the machine tool equipment needs, and every mechanical department officer should seek the suggestions of his shop men as to which tools can be used to the best advantage. In no case should the tools be purchased on price alone. Adaptability for the work in question and reliability of performance should be considered first, and price afterwards. There are tremendous possibilities for economies to be made in the more efficient equipping of our railway shops. With railway earnings as large as they have been for the past year the mechanical department officers should avail themselves of this opportunity for increasing the efficiency of their shops to the utmost, making sufficient investigations to back up their arguments with convincing data.

NEW BOOKS

First Principles of Electricity. By J. E. Homan. Bound in cloth, 248 pages, 5 in. by 7½ in. Illustrated. Published by Sully & Kleinteich, 373 Fourth Avenue, New York City. Price \$1.

As the title of this book indicates, it is prepared for students or persons desiring to take up the study of electricity. It deals with the fundamental ideas of electricity, and is presented in a very simple, concise and understandable manner, devoid of all heavy complication which would otherwise bewilder a reader or student who has not had a previous education in the subject. The book defines electricity and interprets the various terms used in connection with it. It explains the various sources from which electricity may be obtained, giving a description and explaining the purpose of the direct and alternating current dynamos and motors, explaining the principles upon which they work.

CAR AND LOCOMOTIVE ORDERS IN 1916

Year's Business of Over \$550,000,000 Featured by High Prices and Large Foreign Locomotive Sales

IN the 12 months of 1916 the railways, private car lines and other users of cars and locomotives in the United States and Canada placed orders for 2,910 locomotives, 170,054 freight cars and 2,544 passenger cars. In the same period, according to figures compiled by the Railway Age Gazette and published in the issues of that paper for December

rather low, \$87,000,000; about 170,000 freight cars at \$1,500 each, \$255,000,000; and 250 passenger cars at \$18,000 each, \$45,000,000, making a very conservative figure of \$387,000,000. It is not so easy to estimate the total for foreign orders but the value is at least \$170,000,000, making a total for both foreign and domestic car and locomotive business of over \$550,000,000, or well over \$10,000,000 a week.

TABLE I.—ORDERS IN 1916

	Locomotives	Freight Cars	Passenger Cars
Domestic	2,910	170,054	2,544
Foreign	2,983	35,314	109
Total	5,893	205,368	2,653

HIGH PRICES PREVAIL

The outstanding feature in this year's buying has been the prices paid. Freight and passenger cars have actually advanced from 75 to 80 per cent over what they were a year ago; they are now almost three times what they were two years ago at this time. As it happened, however, over one-half the freight car contracts were closed after October 1 or when prices were at their highest. The *Railway Mechanical Engineer* has commented on this in its editorial

29 and January 5, orders were also received from foreign countries by builders in the United States and Canada for 2,983 locomotives, 35,314 freight cars, and 109 passenger cars, making totals, respectively, of no less than 5,893 loco-

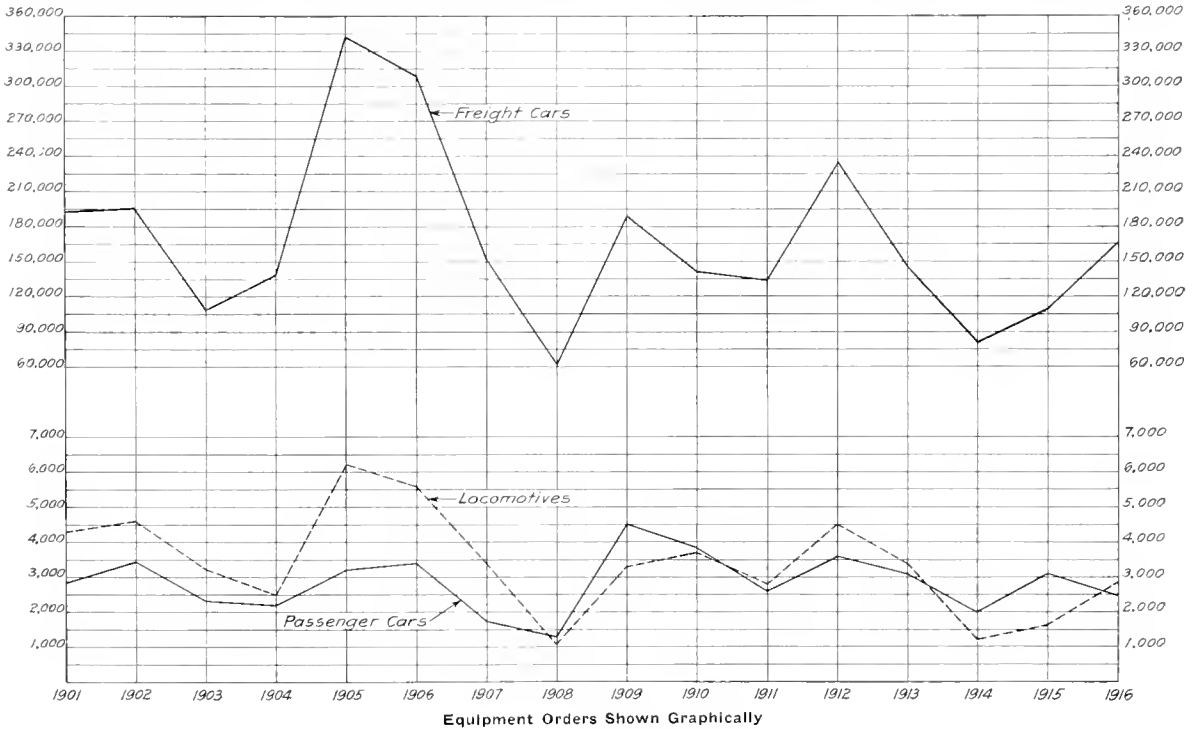

motives, 205,368 freight and 2,653 passenger cars. In view of the exceptionally high prices at which all this equipment has been sold this means that 1916 was undoubtedly the busiest year in the history of the car and locomotive business. Consider, for instance, the domestic orders: About 2,900 locomotives at \$30,000 each, which, if anything, is

columns and has noted that this improper way of doing business resulted because the railways were unable to foresee how prosperous this country would become. For months and months they withheld buying only to be compelled finally to make their purchases when it appeared that the rise in prices was never going to stop.

The increase in locomotive prices has been spectacular enough but the rise has not been quite so great as in the case of freight cars. Locomotive buying has been somewhat steadier except for a few of the summer months with the exceptions that there has been a tremendous amount of foreign buying since October 1. The output of the locomotive plants is now pretty well contracted for until 1918. The Baldwin Locomotive Works has an order from the

TABLE II.—DOMESTIC ORDERS SINCE 1901

Year	Locomotives	Freight Cars	Passenger Cars	Year	Locomotives	Freight Cars	Passenger Cars
1901.....	4,340	193,439	2,879	1909.....	3,350	189,360	4,514
1902.....	4,665	195,248	3,459	1910.....	3,787	141,024	3,881
1903.....	3,283	108,936	2,310	1911.....	2,850	133,117	2,623
1904.....	2,538	136,561	2,213	1912.....	4,515	234,758	3,642
1905.....	6,265	341,315	3,289	1913.....	3,467	146,732	3,179
1906.....	5,642	310,315	3,492	1914.....	1,265	80,264	2,002
1907.....	3,482	151,711	1,791	1915.....	1,612	109,792	3,101
1908.....	1,183	62,669	1,319	1916.....	2,910	170,054	2,544

Frisco for 30 Santa Fe locomotives to be delivered in June, July and August, 1917. A New York Central order for 230 locomotives given to the American Locomotive Company and Lima Locomotive Works, as reported in the October *Railway Mechanical Engineer*, will be delivered about November, 1917; the American Locomotive Company has an order for 50 locomotives from the Paris-Orleans Railway of France also down for delivery next November, and one for 100 locomotives from the French State Railways, designated to be filled in January and February, 1918.

All this means that the car and locomotive plants and equipment specialty manufacturers are fast getting on a peace basis. It is well known and a matter of record that many, if not most, of these plants have been working on large ammunition contracts. While many of them have undoubtedly realized large profits on this business, it is a source of gratification that the prosperity of these companies will henceforth be on a more stable basis.

It will further be a reason for pride that the car and locomotive plants now busy on the manufacture of railway equipment for England, France and Russia will be among the first to help those countries in the work of reconstruction after the war.

PRICES OF LOCOMOTIVES ORDERED

While the increase in the prices of locomotives has not been as marked as that in the case of cars, a conservative estimate will show that locomotives ordered during the past year have cost from \$5,000 to \$20,000 each more than similar locomotives ordered during the year 1914, the average increase during that period being at least 50 per cent. A statement recently made public by the Buffalo, Rochester & Pittsburgh shows that Mikado locomotives were purchased by that road during 1914 at a price of \$20,300, while similar locomotives ordered during 1916 cost \$33,900. A similar comparison of Mallet type locomotives shows an increase from \$32,300 each to \$51,500 each. In both cases the locomotives ordered during the two years are comparable, being of the same design and total weight and were ordered from the same builder. That still further increases in prices during the coming year may be expected is evident from an inspection of the conditions of the material market. A comparison of present prices of some of the materials entering into locomotive construction, with the quotations for one and two years ago, shows the following:

	December 21,	1 year ago	2 years ago.
¼-in. boiler and flange steel, per lb.	\$.0365 to \$.0515	\$.0235	\$.0115
Steel forging billets, per ton.....	80.00	53.00	24.00
2½-in. boiler tubes, per foot of length	.132	.097	.09
Pig iron, per ton.....	23.00 to 35.95	17.40 to 19.95	9.50 to 15.17

As the present prices, or higher, will be effective for locomotives ordered during the early part of 1917, while those of a year ago were probably effective on a large number of the early orders during the present year, there can be no doubt as to the trend of locomotive prices, at least for several months to come.

TYPES OF LOCOMOTIVES ORDERED

The striking feature about the orders for locomotives in 1916 was that the foreign orders were about equal to domestic orders, this resulting because very large purchases were made in this country by England, France and Russia. As far as the domestic orders are concerned there was a very strong tendency toward the increased purchase of Santa Fe and Mountain or Mohawk type locomotives. This is clearly indicated in the two diagrams showing the percentage of each of the important types of locomotives ordered to the total number ordered in each of the last six years. From the actual figures given in Table III it will be seen that the purchases of Santa Fe locomotives totaled 325, as compared with 75 in 1915 and 63 in 1914. The Mountain or

Mohawk type locomotives ordered totaled 184, as compared with orders for 47 locomotives of this kind in the five years from 1911 to 1915. The New York Central and the Southern both ordered a large number of these locomotives, the New York Central's total being no less than 139. The switching and Mallet type locomotives also showed fairly large increases over former years, but the Consolidation and electric showed considerable decreases.

TABLE III.—CLASSIFICATION OF LOCOMOTIVES ORDERED, 1911-1916.

	1916	1915	1914	1913	1912	1911
Mikado	758	562	333	796	1,309	590
Switching	731	227	201	638	821	443
Consolidation	63	225	166	823	858	577
Mallet	218	120	59	72	168	112
Pacific	278	102	174	566	594	486
Santa Fe	325	75	63
Ten-Wheel	40	40	48	255	364	238
Mogul	28	12	23	42	61	127
Mountain or Mohawk.....	184	9	12	24	...	2
Atlantic	2	1	34	46	5	9
American	1	1	19	8	8	27
Electric	43	70	50	94	75	133
Other	239	168	73	103	252	406
Total	2,910	1,612	1,265	3,467	4,515	2,850

It is evident that the Mikado locomotive is losing, while the Santa Fe type is gaining favor for use in heavy freight

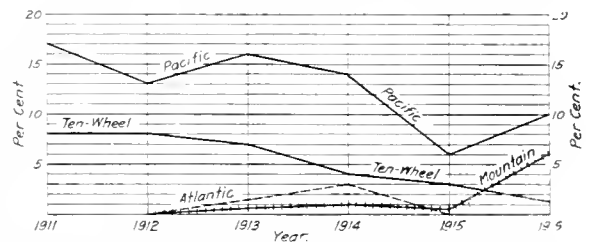

Pacific, Mountain, Ten-Wheel and Atlantic Type Locomotives Shown in Percentages of the Total Number of Locomotives Ordered, 1911 to 1916

service. Considering the success with which locomotives of the latter type have met in service and the ability to provide a flexible driving wheel base which has been made possible by the lateral-motion driving box, the wider application of the Santa Fe type seems assured.

In 1911 the first locomotives of the Mountain type were placed in passenger service on the Chesapeake & Ohio to facilitate the handling of passenger trains on heavy mountain grades without double heading. With the exception of 1912, each succeeding year has seen orders placed for a few of these locomotives. That this type of locomotive is rapidly establishing itself is indicated by the fact that in 1916 orders were placed for 184 of these locomotives for passenger and fast freight service. Few locomotives of the Pacific type have been built with total weights over 300,000 lb. and tractive efforts exceeding 40,000 lb. Such locomotives with average axle loads as high as 67,000 or 68,000 lb. and tractive efforts approaching 50,000 lb. may be considered as constituting the limit of weight and tractive effort which can be reached with the Pacific type.

The average weight of the Mountain type locomotives, now in service or on order, exceeds 330,000 lb. and the possibility of increasing the hauling capacity with these locomotives is well indicated by the fact that they have been built to exert tractive efforts as high as 57,000 lb. with average axle loads slightly under 60,000 lb.

That the Mallet locomotive is giving a good account of itself is indicated by an increase of practically 100 in the number ordered in 1916 as compared with those ordered during 1915. Orders for a considerable percentage of this number were placed by roads which are successfully using the Mallet locomotive in road service. The Virginian placed orders for ten 2-10-10-2 type locomotives to have a total weight of 670,000 lb. and exert a tractive effort of 147,000 lb., and it is also noteworthy that this road has ordered

a Triplex (2-8-8-4 type) locomotive similar to those which have been built for the Erie, of slightly less total weight, 844,000 lb., as against 853,000 lb., but with greater tractive effort, 166,000 lb., as compared with 160,000 lb. This gives the Virginian Triplex the distinction of being the most powerful locomotive yet built.

SOME OF THE BIG ORDERS

During the year some very imposing orders for locomotives were placed. As these have been reported in the news-section of the *Railway Mechanical Engineer* from time to time, it is not necessary to repeat them in detail. It is worth noting, however, that during the year the following roads each placed orders for 50 or more locomotives: Baltimore & Ohio, 100, including 90 with the Baldwin Locomotive Works and the remainder with the Lima Locomotive Works; Boston & Maine, 60, American Locomotive Company; North Western, 142 on two orders, American Locomotive Company; Chesapeake & Ohio, 50, American Locomotive Company; Burlington, 50, Baldwin Locomotive Works; Erie, 53 with the American, Baldwin and Lima Locomotive Companies and in company shops; Great Northern, 75, Baldwin Locomotive Works; Lehigh Valley, 105, Baldwin Locomotive Works; New York Central and subsidiary companies, 507, including 247 with the American Locomotive Company, 260 with the Lima Locomotive Works and 10 with the General Electric Company; New Haven, 50, American Locomotive Company; Pennsylvania, 186, including 75 with the Baldwin Locomotive Works and the remainder at the company shops at Juniata; Pennsylvania Lines West, 50, Baldwin and Lima Locomotive Works; Frisco, 70, Baldwin Locomotive Works; Southern, 111, including 97 with the Baldwin Locomotive Works and 14 with the Lima Locomotive Works.

The foreign buying was done principally by the British,

and Russian Government orders totaled no less than 785 locomotives, including 156 Decapod and 79 small engines from the American Locomotive Company; 150 Decapod and 350 gasoline engines, Baldwin Locomotive Works, and 50 Decapod engines, Canadian Locomotive Company.

IMPROVEMENTS IN LOCOMOTIVE DESIGN

According to the lists of orders published by the *Railway Age Gazette*, of the 2,910 locomotives ordered for domestic service, 2,355 were specified as being equipped with superheaters and 2,233 with brick arches. Special valve gears were specified for 738 locomotives, including 616 Baker and 122 Southern. In addition to that 718 locomotives will be equipped with stokers; 564 Street, 71 Duplex, 45 Hanna, 25 Crawford and 13 Standard.

Superheaters were included on about 80 per cent and brick arches on about 77 per cent of the total number of domestic locomotives ordered. The tendency towards an increase in the degree of superheat has been specially marked during the last six months, increases in the number of units having been specified in many of the locomotives ordered during that time, as compared with similar locomotives built during the past two years.

Economy and capacity increasing devices were during 1916 applied to two existing locomotives for each new one so equipped. Considering the large increase in the number of locomotives ordered this year, considerable acceleration in the improvement of existing power is evident.

The constant increase in the size of locomotive boilers which has taken place during the last few years has led to the serious consideration of the effect of the constantly increasing tube lengths which have thereby been necessitated. It has now been well established that there is an economical limit, beyond which there is little to be gained from additional tube heating surface obtained by increasing the tube lengths. The result of this growing conviction has been reflected in the increase in the number of locomotives, the boilers of which have been built to include combustion chambers, there having resulted therefrom not only a more efficient distribution of the boiler heating surface, but improved combustion due to the increased firebox volume.

Probably the most far reaching development of recent years, not only in improved efficiency of combustion and boiler performance, but more particularly when considered from a broad economic standpoint, is the use of pulverized coal in locomotive service. This has been developed to a point where satisfactory results have been obtained in service, in about three years, and its economic possibilities are such that in view of the constantly increasing price and commercial demand for coal, the next few years may see it well established as a regular feature in locomotive service.

That the number of mechanical stokers in service during the past year has increased fully 75 per cent is the natural sequence of the large number of the Mikado, Santa Fe and Mallet types which have been ordered during the year, most of these locomotives requiring a rate of firing to develop their full capacity well beyond the possibilities of hand-firing.

The use of heat-treated carbon and alloy steels for reciprocating parts, crank pins, axles, etc., has now become well established. Many of the problems of running gear design presented by the high power which must be transmitted from a single pair of cylinders in large single-unit locomotives have been greatly simplified by the availability of such material and the past year has seen its use extended to several additional railroads.

The lateral motion driving box for providing radial action to driving axles, which was first applied to 2-10-2 type locomotives built in 1915 for the New York, Ontario & Western and the Erie, has been applied to more than 60 locomotives ordered during the past year.

Concerning the foreign orders it is noteworthy that until

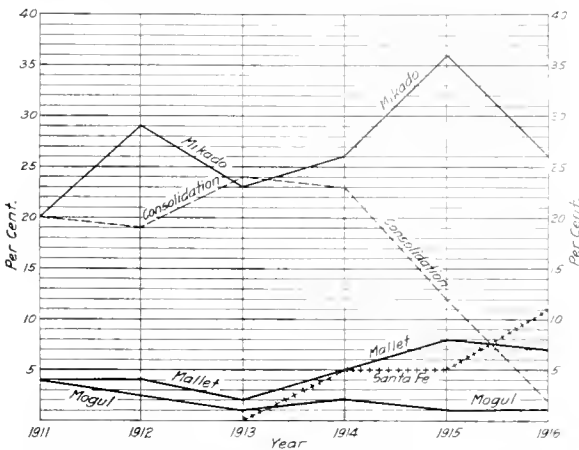

Mikado, Santa Fe, Mallet, Consolidation and Mogul Type Locomotives Shown in Percentages of the Total Number of Locomotives Ordered, 1911 to 1916

French and Russian Governments. The British Government ordered 565 small engines from the Baldwin Locomotive Works, 100 from the American Locomotive Company and 40 larger engines from the Canadian Locomotive Company. The French Government ordered 255 small locomotives from the Baldwin Locomotive Works and 100 larger engines from the American Locomotive Company. In addition to these, orders were also placed by the Paris-Lyons-Mediterranean for 140 Mikado engines with the Baldwin Locomotive Works and by the Paris-Orleans Railway for 100 Mikado locomotives with the American Locomotive Company. The Italian State Railways ordered 100 Consolidation locomotives on two orders from the American Locomotive Company. The Rus-

this year, with the exception of locomotives built for Russia, these engines have generally been built to the foreign designs. During the latter part of the present year orders have been received from France, Spain and Italy, which are being built to American designs.

A comparison of the number of locomotives of the various types ordered during 1915 and 1916 clearly indicates that there has been no decrease in the tendency toward constantly increasing power units. While the 2-10-2 type will undoubtedly retain its supremacy for several years in heavy road freight service, it is evident that the limit of its capacity will soon be reached and the difficulties in the way of increasing the size of simple cylinders beyond that required by the 10-coupled wheel base, indicates that but little more can be done in the development of single unit locomotives operated by a single pair of simple cylinders beyond the possibilities in the types now in existence. Although in general the Mallet locomotive has never been favorably considered as a road engine, it has been successfully used in road service for some time on a number of railroads and it offers possibilities for further development along that line.

FREIGHT CARS ORDERED

The total of 170,000 freight cars ordered shows a very considerable increase over 1915 and is over twice as large as the total for 1914. In fact, the total is the best with the exception of 1912 since 1906. As far as the total value of orders placed is concerned it has been one of the best years in the history of the business. With the sudden demand for raw materials by the munition manufacturers, the price of steel has soared very high. The price of lumber has increased but little, and what increase has occurred has been

many cars were ordered the last half of 1916 as were ordered during the first half, November being the heaviest month for the past three years. Needless to say, the orders have been restricted to provide for only those cars which were absolutely necessary, but still the orders placed for the year approach very nearly the 15-year average which has been referred to above.

The outstanding feature in this year's totals, as shown in Table A, is the reversion to all-wood or composite underframe cars. Only 1,560 all-steel box cars are reported as against a total of 11,005 in 1915. This, of course, is partly due to the absence of large Pennsylvania orders for all-steel box cars, but even taking that into consideration it shows very strikingly with the increase of composite underframe box cars from 1,225 to 12,560, and in all-wood cars from 601 to 6,416 from 1915 to 1916, the effect of the exceedingly high prices and poor deliveries of steel.

Of the total of about 165,000 cars ordered for use in the United States and Canada, the greatest increases over last years are in the composite and steel underframe type, both of which show gains much larger proportionately than the increase in the total number of cars ordered, while there is almost no increase in the number of all-steel cars ordered. Considering the conditions of the raw material markets, both as to prices and deliveries, it is not surprising that the tendency has been to use as little steel in car construction as possible, and the returns can in no way be considered as indicating a tendency toward wood construction on its own merits.

The number of cars of all-wood construction ordered during the year shows an increase of over 40 per cent as compared with the number ordered during 1915, but the total

TABLE A.—CLASSIFICATION OF FREIGHT CARS ORDERED DURING 1916.

	All Steel frame and steel underframe			Composite underframe	Wood	Not specified	Total	Draft Gear		
	All Steel	Steel underframe	Steel underframe					Spring	Friction	Not specified
	a	b	c	d	e	f	g	h	i	j
Box	1,560	12,261	24,256	12,650	6,416	5,450	62,593	18,985	25,819	17,780
Refrigerator	3,191	100	1,168	2,515	6,974	2,662	1,297	3,015
Hopper, including ore	30,940	750	760	3,926	35,376	6,073	30,977	9,326
Gondola	7,829	4,007	5,648	3,500	9,063	30,050	10,350	10,125	9,575
Coal (not otherwise specified)	560	75	1,000	1,635	575	1,060
Stock	800	3,260	500	825	1,360	6,745	1,615	2,950	2,180
Flat	2,313	73	651	155	3,192	218	1,358	1,616
Tank	13,637	6	13,643	12	13,320	311
Chooose	7	145	218	206	15	51	642	290	83	269
Miscellaneous or not specified	361	900	169	9	312	6,453	8,204	602	846	6,756
Total	57,207	18,113	37,492	17,038	10,225	29,979	170,054	40,807	77,350	51,897

due to the advance in the cost of labor and materials used in its manufacture and more recently to the shortage of cars. Labor throughout the country has become much more expensive. All of these conditions have a material bearing on the cost of car construction and on the fact that the prices now paid are 75 per cent more than those paid under normal conditions. As much as \$1,800 has been paid for box cars, and over \$2,200 for refrigerators. A conservative estimate of the average prices being paid for all freight cars has been given as \$1,500. This has placed a serious burden on the railroads, especially on account of the fact that they have had to buy large amounts of new equipment.

From 1901 to 1915, inclusive, there was a total of 2,623,425 cars ordered—an average of 174,895 cars per year. During the first seven years of this period the average was 205,361 cars per year, while for the following eight years the average was but 148,238. This shows that at the beginning of 1916 the roads were considerably short of their equipment requirements. To be sure, the increase in the capacity of cars has been responsible for some of this decrease in the number bought, but the small earnings of the railroads during the latter period are responsible for most of it.

With the railroads thus behind in the matter of equipment, they have been forced to increase their orders for cars this year notwithstanding the high prices. About twice as

many cars ordered shows an increase of over 50 per cent compared with 1915. Indeed it is remarkable that the increase in this type of construction was not larger and it seems apparent that it has been resorted to more where the necessity for immediate deliveries was the paramount consideration, rather than from considerations of price.

In addition to the embarrassment of high prices, the roads have been handicapped by long delivery. Six to nine months is the best that can be expected, and on tank cars a year to a year and a quarter is not uncommon. The unprecedented demand for oils and gasoline both for export and for domestic use, has created a demand for this latter class of equipment, and is responsible for the large number of tank cars ordered this year. With peace negotiations between the warring nations taking a somewhat favorable aspect there is hope for better prices and better delivery within the next year.

THE BIG FREIGHT CAR BUYERS

Several of the railroads made unusually large purchases of freight cars. As details of most of these orders have been given from time to time in the *Railway Mechanical Engineer*, it will be sufficient to say here that orders for over 3,000 freight cars were placed by each of the following roads: Baltimore & Ohio; Chesapeake & Ohio; Chicago & North Western; Burlington; St. Paul; Erie; Illinois Cen-

tral; Louisville & Nashville; New York Central; Pennsylvania; Reading; Southern; Southern Pacific; Union Pacific and Union Tank Line.

The French State Railways were reported as having ordered 11,500 cars; the Italian State Railways, 3,000; the Paris-Lyons-Mediterranean, 1,500; the Paris-Orleans, 3,600, and the Russian Government, 7,155.

PASSENGER CARS ORDERED

There has been no such reversion to wooden cars as has been noted in the case of freight cars. This is the best possible evidence that the all-steel passenger car has come to stay, and this for the reason that the prices of passenger cars have advanced in even greater proportion than has been the case with freight cars. Practically the only wooden cars ordered were some ordered for Canadian roads. Practically all the cars have been specified as being equipped with electric lighting.

Among the companies that placed orders for over 100 passenger cars were the Baltimore & Ohio, Canadian Northern, Canadian Pacific, New York Central, Pennsylvania and the Pullman Company.

EQUIPMENT BUILT

The Railway Age Gazette also gives figures as to the output of cars and locomotives. During 1916 there were built in the car and locomotive plants and railroad shops 4,075 locomotives, 135,001 freight cars and 1,839 passenger cars, a considerable increase over last year's low figures of 2,085 locomotives, 74,112 freight cars and 1,949 passenger cars. This year's totals, however better they may be than

TABLE IV. OUTPUT, 1899-1916

Year	Locomotives	Freight Cars	Passenger Cars
1899.....	2,475	119,886	1,305
1900.....	3,153	115,631	1,636
1901.....	3,384	136,950	2,055
1902.....	4,070	162,599	1,948
1903.....	5,152	153,195	2,007
1904.....	3,441	60,806	2,144
1905*.....	5,491	165,155	2,551
1906*.....	6,952	240,503	3,167
1907.....	7,362	284,188	5,457
1908*.....	2,342	76,555	1,716
1909.....	2,887	93,570	2,849
1910*.....	4,755	180,945	4,412
1911*.....	3,530	72,161	4,246
1912*.....	4,915	152,420	3,060
1913*.....	5,332	207,654	3,296
1914*.....	5,335	104,541	3,691
1915*.....	2,085	74,112	1,949
1916*.....	4,075	135,001	1,839

* Includes Canadian output. ** Includes Canadian output and equipment built in railroad shops.

1915's figures, do not begin to express the real prosperity of the business for the reasons (1) that so large a proportion of the orders were placed in the last three months of the year, (2) because they do not indicate the high prices and (3) because, as previously noted, they cannot show the munitions orders. Of the 4,075 locomotives built, 2,708 were for domestic and 1,367 for foreign companies. Of the 135,001 freight cars, 113,692 were for domestic and 21,309 for export business, and of the total 56,053 are specified as being of all-steel construction, 59,636 as having steel underframes, 8,849 as being of wood and the remainder are not specified. Of the 1,839 passenger cars, 1,769 were for domestic use and 70 for export. Of the total, 1,600 are specified as being of all-steel construction, 200 as having steel underframes and 39 as being of wood.

It will be noted that foreign orders play an important part in the builders' activities. Some companies, particularly those in Canada, almost specialized on foreign orders. As was the case last year, also, a number of American companies confined their activities almost entirely to doing repair work for railroads.

STEAM PIPE JOINT RINGS

The accompanying illustration shows the method followed by the Chicago Great Western for the application of steam pipes. It is sometimes difficult to cast and machine the joints in steam pipes so that they will match exactly between the nigger head and the cylinder casting. The arrangement of joint rings shown provides a leeway of 1/4 in. The joint rings for cylinder ends of the steam pipes are turned concentric, while those for the nigger head ends have the two

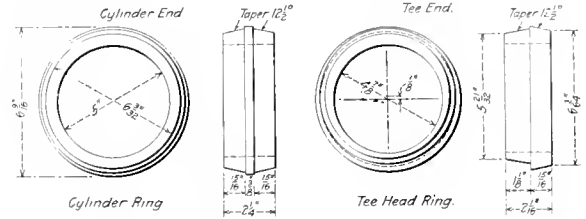

Joint Rings Used to Adjust for Inaccuracies in Steam Pipes

bearing faces 1/8 in. off center. By turning the rings until a perfect contact is obtained between both the steam pipe and the nigger head, a connection can be obtained without difficulty within the limits of a 1/4 in. variation, as above mentioned. This has been used for the past two years with very satisfactory success.

ANNUAL REPORT OF THE CHIEF INSPECTOR OF LOCOMOTIVE BOILERS*

The annual report of Frank McManamy, chief inspector of locomotive boilers, Interstate Commerce Commission, for the fiscal year ended June 30, 1916, has recently been published. During the year the work of this division has been materially changed and increased by the broadening of its scope to include the inspection of the entire locomotive and tender. The inspection rules and instructions concerning the inspection of locomotives and tenders were formulated during the year, and while the enforcement of them required no material change in the form of the organization of the division, it caused a substantial increase in the work of the inspectors, which is reflected by the number of locomotives inspected during the year. Much of the time of the inspectors was taken in what might be termed "educational work," so that the railroad inspectors and officers might have a correct and uniform understanding of the requirements of the law. The present inspectors were examined by the United States Civil Service Commission concerning their qualification and fitness to perform the additional inspections, and all the inspectors employed by the division passed a very creditable examination.

As the work of this division now embraces the entire locomotive and tender, the tabulation of accidents, injuries and defects found is such that no practical basis exists upon which the comparative tables of accidents as shown in former reports can be continued. The following is a summary of the tabulated data contained in the report:

Number of locomotives inspected.....	52,650
Number found defective.....	24,685
Percentage found defective.....	47
Number ordered out of service for repairs.....	1,943
Number of accidents.....	537
Number killed.....	38
Number injured.....	509

There were 71,527 defects found on the 24,685 defective locomotives. Of this number something over 23,000 defects are those which do not pertain to the boiler and its appur-

* A brief summary of the work of the division of boiler inspection, taken from the annual report of the Interstate Commerce Commission, was published last month, page 632.

tenances The following is a tabulation of the more important defects enumerated in the report:

Brake equipment	1,965
Cylinders, saddles or steam chests	5,395
Draw gear	1,562
Lateral motion	728
Rods, main or side, crank pins, or collars	1,176
Springs or spring rigging	1,671
Tanks or tank valves	1,594
Tender trucks	1,295
Wheels	1,407

This gives a clear idea of what the railroads should watch in the maintenance of locomotives and tenders. In this connection the report shows illustrations of locomotives in service with steam leaks which are such that the view of the engineer is almost entirely obscured. Mention is also made of an accident caused by the steam heat hose coupling on the rear end of the tender of the first engine on a double headed passenger train catching in a switch point, derailling the second locomotive and wrecking the train. The steam hose coupling hung too low, and was not hooked up as it should have been. This accident resulted in the death of six persons, serious injury to ten persons, and caused a property damage estimated at \$14,565. The speed at which these engines were running was estimated at 40 m. p. h. This accident serves to illustrate the importance of looking after and repairing the small and sometimes apparently unimportant defects before locomotives are allowed to go in service.

Table I shows the number of persons killed and injured by failure of locomotive boilers or their appurtenances during the year ended June 30, 1916, and by failure of any part of locomotives or tenders since the amendment regarding the locomotive and tender inspection became effective, the classification being according to their occupations.

Briefly summarizing the accidents, and the casualties resulting therefrom, caused by the failure of locomotive boilers and their appurtenances only, for the purpose of

TABLE I.—CASUALTIES CLASSIFIED BY OCCUPATIONS

	Killed.	Injured.
Members of train crews:		
Engineers	11	205
Firemen	12	225
Brakemen	9	74
Conductors	1	6
Switchmen		6
Roundhouse and shop employees:		
Boilermakers	1	11
Mechanists	1	11
Foremen	1	3
Inspectors	3	3
Watchmen		8
Boiler washers		10
Hostlers		6
Other roundhouse and shop employees	1	21
Other employees		7
Non-employees	1	3
Total	38	599

comparison, it shows there were 352 such accidents with 29 killed and 407 injured thereby. This is a decrease over the preceding year in the number of accidents and in the number of casualties, but an increase in the number killed. This increase in the number of fatalities is due almost entirely to one single class of accidents, namely, crown sheet failures due to low water, where contributory causes of neglect were found, and forcibly emphasizes the importance of properly maintaining water gages and boiler feeding appurtenances. Attention is called to the fact that during the period covered by this report unprecedented traffic conditions necessitated the use of over 6,000 more locomotives than in the preceding year.

Table II is a list of the accidents and casualties resulting from failures of locomotive boilers or their appurtenances during the year ended June 30, 1916, and by failures of any parts of locomotives or tenders since the amendment concerning the inspection of locomotives and tenders became effective, the classification being by parts or appurtenances causing the accidents.

A number of applications for extension of time for the removal of flues was asked for, and of 653 applications 103

were not granted, 79 were given part of the time asked for, 63 extensions were granted after defects disclosed by the government inspectors had been repaired, 43 were withdrawn, and the remaining 365 were granted as requested.

The total number of requests was much less than for the preceding year. The report also states that the roads with but few exceptions are bringing the locomotive boilers up to the required factor of safety in a satisfactory manner, and that all boilers will be brought up to the established standard within the limit of time set by the commission. The report closes by stating: "It is only fair to state that a large majority of the carriers are diligent in their reports

TABLE II.—ACCIDENTS AND CASUALTIES CLASSIFIED BY PARTS OR APPURTENANCES

Part or appurtenance which caused accident.	Year ended June 30, 1916.		
	Accidents.	Killed.	Injured.
Air reservoirs	6	..	9
Aprons	2	..	2
Arch tubes	5	1	7
Ashpan blowers	4	1	4
Asdes	4	..	4
Blow-off cocks	19	..	20
Boiler checks	8	..	9
Boiler explosions:			
A—Shell explosions
B—Crown sheet; low water; no contributory causes found	23	7	38
C—Crown sheet; low water; contributory causes or defects found	16	13	21
D—Firebox; defective staybolts, crown stays or sheets	1	..	3
E—Firebox; water foaming	1	..	2
Brakes and brake rigging	4	1	6
Couplers	4	..	7
Crank pins, collars, etc.	8	..	9
Cress heads and guides	3	..	4
Cylinder check rigging	1	..	1
Cylinder heads	1	..	1
Dome caps	1	1	..
Draft appliances	1	..	2
Draw gear	22	2	21
Fire doors, levers, etc.	2	..	2
Flues	37	..	46
Flue pockets	1	..	2
Footboards	2	..	2
Gage cocks	2	..	1
Grease cups	3	..	3
Grate shakers	23	..	23
Handholds	4	1	3
Headlights and brackets	6	..	7
Injectors and connection (not including injector steam pipes)	27	..	28
Injector steam pipes	11	..	14
Lubricators and connections	13	..	13
Lubricator glasses	11	..	11
Patch bolts	2	..	3
Pistons and piston rods	5	1	4
Plugs (arch tube and washout)	17	2	22
Plugs in firebox sheets	3	..	3
Reversing gear	38	..	38
Rivets	4	..	4
Rods (main and side)	15	1	16
Safety valves	1	..	1
Sanders	1	..	1
Side bearings	1	..	1
Springs and spring rigging	8	2	7
Steam hose	62	1	61
Staybolts	1	..	1
Steam piping and blowers	16	..	22
Steam valves (inside and outside of cab)	10	1	13
Studs	10	2	8
Superheater tubes	3	..	4
Throttle glands	1	..	1
Throttle leaking	1	..	1
Throttle rigging	5	1	4
Valve gear, eccentrics and rods	7	..	7
Water bars	1	..	1
Water glasses	29	..	29
Water glass fittings	7	..	7
Miscellaneous	14	..	15
Total	537	38	599

to comply with the requirement of the law, and are sincerely co-operating with us with that end in view, and in such cases the beneficial results are particularly noticeable.

"A few carriers have attempted to place the burden of inspecting their locomotives upon us by continuing to use defective equipment until found and ordered out of service by a government inspector, which has resulted, in some instances, in considerable inconvenience to the shippers. While this is to be regretted, and is avoided as far as possible, we cannot permit it to influence our actions where we find evidence of the disposition on the part of railroad officials to use locomotives that are defective and in violation of the law."

PULVERIZED FUEL FOR LOCOMOTIVES*

Abstract and Discussion of a Paper Presented
Before the Railroad Session of the A. S. M. E.

BY J. E. MUHLFELD
President, Locomotive Pulverized Fuel Company

TO establish satisfactory credit in order to provide adequate capital at reasonable cost, a steam railway must preserve the proper ratio between gross operating revenues and expenses; and this ratio is largely contingent upon the effectiveness of its developed means for moving traffic. As next to labor the largest single item of cost for transportation is the fuel used in locomotive operation; and as in the final analysis the cost per revenue passenger or per ton-mile is largely conditional upon the capacity, effectiveness and economy of the unit of motive power per hour, it is easy to realize to what extent the credit of a steam railway is controlled by its locomotive performance.

Expenditure for locomotive fuel for the steam railways in the United States now approximates \$300,000,000 per annum, of which from \$75,000,000 to \$100,000,000 represents the proportion that is expended to kindle, prepare, clean, and maintain fires on grates when locomotives are standing, drifting or otherwise not actually using steam to move themselves, either light or with trains. For the fiscal year ended June 30, 1914, the Interstate Commerce Commission reports a total of 64,760 locomotives of all classes in the United States having made a total of 1,755,972,325 miles. This gives an average for each locomotive owned of about 27,115 miles per annum, 74 miles per day, or but little over 3 miles per hour. From the foregoing figures it is easy to imagine that over one-half of the time of locomotives is now spent at terminals in the hands of the transportation and mechanical departments, and that most of this delay is due to the necessity for cleaning fires, ashpans, flues and smokeboxes; inspecting and repairing draft, grate and ashpan appliances; and for firing up and supplying firing tools and equipment. Frequently the delays to locomotives waiting to reach ashpit tracks and to rekindle fires exceed the time required to do this work; meanwhile fuel is needlessly consumed and the boiler subjected to excessive contraction and expansion.

The opportunity for reducing the non-productive time of existing locomotives and for relieving terminal congestion that is now caused by the necessity for cleaning fires, ashpans, flues, and smokeboxes; inspecting and repairing draft, grate and ashpan appliances and for firing up and supplying firing tools and equipment to locomotives burning coal on grates, makes the use of pulverized fuel one of the most effective and economical means for increasing the net earning capacity of present single and double track steam roads. Steam locomotives will be equipped to approximate electric service by the use of pulverized fuel, which in turn will eliminate smoke, soot, cinders, sparks and fire hazards; reduce noise, time for despatching at terminals, and stand-by losses; and increase the daily mileage by having more nearly continuous service between general repair periods.

With pulverized fuel a locomotive having the boiler filled with cold water may be brought under maximum steam pressure within an hour, and the fuel feed then stopped until it is called for service. When standing or drifting at terminals or on the road, the fuel feed can also be discontinued as the steam pressure can always be quickly raised. After the trip or day's work the locomotive can be immediately stored or housed, the usual ashpit delays being entirely eliminated. The possibilities for increasing the productive

time of existing locomotives and for relieving terminal congestions that are now brought about by the necessity for cleaning and rebuilding fires on grates, makes the use of pulverized fuel one of the most attractive and quickest methods for increasing earning capacity.

The principal fuels adaptable for use in pulverized form in locomotives are anthracite, semi-anthracite, semi-bitu-

TABLE I PERFORMANCES OF TEN-WHEEL TYPE LOCOMOTIVE WITH PULVERIZED COAL

	1	2	3
Fuel	Bituminous	Bituminous	Bituminous
Finesness, per cent through 200 mesh	0.85	0.85	0.85
Moisture, per cent	0.40	0.81	0.59
Volatile, per cent	24.72	36.27	24.36
Fixed carbon, per cent	68.43	58.29	65.05
Ash, per cent	6.85	5.44	10.59
Sulphur, per cent	1.96	0.68	0.84
B.t.u., per lb.	14,739	14,334	13,912
Miles run, total	1,324	436	398
Cars per train, average	61	65	60
Adjusted tonnage per train, average	1,719	1,808	1,759
Speed when train was in motion, miles per hour, average	26	25	24
Boiler pressure when using steam (200 lb.), average	198.3	193.5	194.9
Front-end draft when using steam, m. of water, average	7.15	7.79	6.69
Firebox draft when using steam, in. of water, average	3.50	3.22	3.18
Temperature of steam, deg. F.	562	573	555
Coal fired per hour of running time, lb. (average)	3,275	3,063	3,457
Adjusted ton-miles per lb. of coal (average)	12.84	13.97	11.59

minous and bituminous coals, lignite and peat. These fuels differ more in physical characteristics than in chemical composition, but as the carbon and hydrogen content are the most valuable elements and determine the calorific value, they are usually taken into account for classification purposes. The "clinking" and "honeycombing" of ash is one of the worst troubles to be contended with in the combustion of coal, and its formation may be either chemical or by fusion. Clinker is of two kinds, hard and soft. Hard clinker is formed by the direct melting of some of the ash content. It hardens as it forms and usually gives but little trouble. Soft clinker is formed by the slagging of the ash and is either pasty or fluid and steadily grows in size. "Honeycomb" or flue-sheet clinker is formed by the condensation or coking of tarry matter or vapor as it strikes against the firebox sheets, and results in the accumulation of a relatively soft, light, ashy substance that grows or spreads over certain of the refractory or metal parts of the furnace.

With the use of pulverized fuel the usual difficulties resulting from the formation of hard and soft clinker on grates are eliminated, but with fuels containing certain intrinsic combinations of ferrous silicates which fuse at comparatively low temperatures (2,000 to 2,300 deg. F.) the honeycomb formation will result when the proper air-supply and combustion conditions do not obtain to produce ferric silicates, which fuse at 2,500 deg. F., and above.

The performances of a ten-wheel type freight locomotive,* rated at 31,000 lb. of cylinder tractive effort, with 69-in. driving wheels, is shown in Table I. It was used in fast through-freight service on runs 91 to 138 miles in length, testing various fuels under identical conditions.

The locomotive was worked at its maximum capacity on

*For an illustrated description of the locomotive equipment for burning pulverized coal see the *Railway Mechanical Engineer* for March, 1916, page 114.

*The operation of this locomotive was referred to in articles on page 213 of the *Railway Mechanical Engineer* for May, 1915, and on page 565 of the November, 1916, issue.

all trips, about 10 per cent more tonnage being hauled than usual for like locomotives burning coal on grates, and at practically fast-freight schedule speed. The exhaust-nozzle opening was about 25 per cent larger than the maximum for hand firing. The general results were excellent, particularly as regards tonnage, speed, combustion, and steam pressure, the latter being maintained at full speed with the injector supplying the maximum amount of water to the boiler.

With the highest-sulphur coal (No. 1) and the highest-ash coal (No. 3) there was less than 1 cu. ft. of slag in the slag box at the end of each run, and practically no collection of ash or soot on the flue or firebox sheets. In fact, with the No. 3 fuel there was less than 2 handfuls of slag, ash and soot collected on each trip.

The steam railways in the anthracite-coal-mining district generally use for their locomotive fuel mixtures which will run from 25 to 50 per cent of bituminous and the balance of anthracite pea and buck sizes which will pass through a 3/8-in. and over a 5/16-in. round opening. As anthracite coal is very low in volatile, ignites slowly, and is a poor conductor of heat, the bituminous mixture is used to overcome the trouble this causes when the smaller sizes must be burned on grates, and even then it necessitates the use of unusually small exhaust nozzles to create sufficient draft.

In the experiments with pulverized anthracite fuel for locomotives the idea has been to utilize the grade of coal of lowest commercial value, such as birdseye, which is of a size that will pass through a 5/16-in. and over a 1/16-in. round opening, as well as the refuse called culm or slush, which passes through the 1/16-in. round opening and is usually wasted in the washery water or used for back-filling the mines. To reclaim this slush a couple of wooden bins were installed, through which the washery water could be finally passed for the collection of the solid matter. The analyses of the fuels used are given in Table II.

TABLE II.—ANALYSES OF FUELS USED IN EXPERIMENTS WITH PULVERIZED ANTHRACITE AND BITUMINOUS MIXTURES.

Item	Anthracite	
	Run-of-mine	Birdseye Slush
Moisture, per cent.....	0.50	0.50 1.00
Volatile, per cent.....	29.50	7.50 6.00
Fixed carbon, per cent.....	60.00	77.00 71.00
Ash, per cent.....	10.00	15.00 23.00
Sulphur, per cent.....	1.50	1.00 2.5
B.t.u., per lb.....	13,750	12,750 11,250
Fineness, per cent through 200 mesh...	86.00	86.00 86.00

At the commencement of the development work the locomotive was equipped with an arrangement of refractory baffles and fuel and air inlets for burning 100 per cent bituminous coal, and after this had been properly accomplished successive adjustments were made to burn the following mixtures, the last of which is now being used with as satisfactory results as the 60 per cent bituminous and 40 per cent birdseye:

- First.—75 per cent run-of-mine bituminous and 25 per cent anthracite Birdseye.
- Second.—67 per cent run-of-mine bituminous and 35 per cent anthracite Birdseye.
- Third.—60 per cent run-of-mine bituminous and 40 per cent anthracite Birdseye.
- Fourth.—60 per cent run-of-mine bituminous and 40 per cent anthracite slush.
- Fifth.—50 per cent run-of-mine bituminous and 50 per cent anthracite slush.
- Sixth.—40 per cent run-of-mine bituminous and 60 per cent anthracite slush.

Further work along this same line will determine just how great a percentage of anthracite slush can be used to the best advantage, but the evaporative results so far obtained, i.e., about 7 lb. of water from feed-water temperature per lb. of coal, indicates that considerably more than a 60 per cent anthracite-slush mixture may be utilized. This accomplishment not only means a decrease of 25 per cent in the cost per ton for locomotive fuel, but also the release of a large tonnage of commercial anthracite, which is becoming more scarce and in greater demand each year.

The principal trouble to be overcome has been on the intermittent runs, as it is more difficult to maintain proper

combustion with a slow fire and to re-ignite the fuel after the feed has been stopped for a time, with the low than with the higher volatile coals.

The same increase can be made in the size of the exhaust-nozzle openings (about 25 per cent) for anthracite as for bituminous coal when burning in pulverized form, as compared with hand firing of coal on grates.

The development of sufficient drawbar pull in a Consolidation type of freight locomotive with 63-in. diameter driving wheels, rated at 61,400 lb. of cylinder tractive power, to haul a freight train of 23 loaded cars (representing about 1,562 actual tons) over a ruling grade of 1 1/2 miles of 1.65 per cent grade with a 6-deg. curvature, further indicates the advantages of sustained boiler horsepower in combination with reduced cylinder back pressure, which is only made possible by this method of burning fuel.

The average results of a number of trips made by an Atlantic type passenger locomotive, rated at 21,850 lb. cylinder tractive effort, with 81-in. diameter driving wheels, when used in high-speed passenger service on round-trip runs of 171 miles in length, are shown in Table III.

TABLE III.—PERFORMANCE OF ATLANTIC TYPE PASSENGER LOCOMOTIVE Analysis of Fuel Used

Kentucky unwashed screenings—	Per Cent
Fineness, through 200 mesh, per cent.....	83
Moisture, per cent.....	2.46
Volatile, per cent.....	36.00
Fixed carbon, per cent.....	54.00
Ash, per cent.....	7.94
Sulphur, per cent.....	0.79
B.t.u., per lb.....	13,964

Locomotive Performance

Miles run.....	171
Running time, hours.....	3.87
Train, number of cars.....	5.8
Speed, miles per hour.....	291
Drawbar pull, pounds.....	44.2
Horsepower per hour.....	2,711
Fuel used, tons.....	319.5
Water used, gallons.....	3.82
Fuel per hp.-hour, lb.....	8,381
Water per hp.-hour, lb.....	6.17
Evaporation, water per lb. of coal, lb.....	56.48
Evaporation from and at 212 deg. F., lb.....	9.15
Boiler efficiency, per cent.....	11.1
	77

The combustion results may be indicated by the smokebox-gas analysis given in Table IV.

TABLE IV.—SMOKEBOX GAS ANALYSIS FOR THE TEST RECORDED IN TABLE III

Pounds of coal burned per hour	CO ₂ Per Cent	CO Per Cent	O Per Cent
3,067	14.5	0.0	4.5
3,498	15.2	0.0	2.8
3,931	15.2	0.0	4.0
4,000	16.0	0.4	2.6

This locomotive could be fired for the round trip with a variation of not over two pounds in the boiler pressure, and the size of the exhaust nozzle used was 5 1/2 in. in diameter and the temperature of the superheated steam averaged about 635 deg. F. for steam of 185 lb. boiler pressure and the smokebox gases about 460 deg. F., although maximum temperatures of 715 deg. F. for superheated steam and of 482 deg. F. for smokebox gases were recorded.

From tests made with pulverized lignite having an analysis of about 1.8 per cent moisture, 47 per cent volatile, 41 per cent fixed carbon, 9.5 per cent ash, and 0.75 per cent sulphur, and a heating value of 10,900 B.t.u. per lb., in regular passenger locomotive service, the same satisfactory results were obtained as with bituminous coals, the combustion and operation being entirely smokeless, sparkless and cinderless, and the steam pressure being fully maintained.

With pulverized fuel the control of the fuel feed and thereby of the over- or under-production of steam is nearly perfect. A locomotive can be fired up and the fuel consumption then stopped until a few minutes before starting time. At the end of the run, or when drifting, the fire can be extinguished at will and quickly re-ignited without any special equipment or materials. A locomotive with boiler full of water and 185 lb. of steam pressure, after standing 11 hours, without fire, still had 80 lb. of steam pressure.

Comparative tests made between similar locomotives

in the same service resulted in the use of 2,775 lb. of lump coal, hand-fired to get up steam and for terminal handling and dead time, as compared with 1,569 lb. of pulverized screenings to produce the same result, or an increase of over 75 per cent. The greatest saving is in the firing up alone, this requiring 1,700 lb. of lump coal as compared with 750 lb. of pulverized screenings, or an increase of over 225 per cent. In the engine-house terminal handling there is the least possible delay and expense. No more time or facilities are required than for fuel-oil-burning locomotives. A locomotive fired up at 6 a. m. can leave with its train at 7 a. m., and upon arrival at the destination engine-house can be immediately fueled, watered and housed, the slag-pan being dumped over the engine stall pit.

Through the possibility of enlarging exhaust-nozzle openings from 25 to 50 per cent as compared with the areas required for burning coal on grates or fuel oil, the full benefit of expenditures for improved cylinders, valves and valve gears, particularly in connection with cylinders of large volume, can now be obtained. Heretofore the necessity for maintaining relatively small exhaust-nozzle openings to produce the required firebox draft has enabled but little benefit to be gained from improved steam distribution, as cylinder back pressures of from 15 to 30 lb. when operating at maximum capacity of engine and boiler are not at all uncommon in some of the most recently built stoker-fired single-expansion locomotives. As every pound of cylinder back pressure saved is equal to at least two pounds added to the boiler pressure when a locomotive is working at its maximum capacity, and further provides less wear and fuel consumption, the benefits to be derived are obvious.

As the limiting factor of a steam locomotive is, or should be, the ability of the boiler to produce steam, the rate and effectiveness of combustion become the controlling factors. When coal is burned on grates a rate of about 50 lb. of run-of-mine, and of about 60 lb. of lump bituminous coal, per sq. ft. of grate surface per hour is the maximum allowable for the greatest boiler efficiency. However, as this limits the rate of consumption to a total of from 3,000 to 6,000 lb. per hour for the average modern locomotive of great power, and as the actual coal supplied to the firebox by mechanical stoking frequently reaches a rate of 150 lb. per sq. ft. of grate area, or a total of from 9,000 to 15,000 lb. per hour, the boiler efficiencies frequently run as low as from 55 to 45 per cent and even less. Therefore the necessity for eliminating grates if much over 12 lb. of water per sq. ft. of evaporating surface per hour is to be obtained efficiently.

From results established during the past six months, the quantity of live steam required for the operation of pulverized fuel burning equipment when the locomotive is being worked at its maximum boiler-horsepower capacity, is about 1½ per cent of the saturated steam generated, which is considerably less than what is required for the steam-jet operation of mechanical stokers when firing coal on grates, and very much less as compared with what is used in the generally existing steam-jet practice of burning fuel oil; this latter amount, according to reports made by the U. S. Naval Board, is about 6 per cent of the total steam generated.

Comparing the use of pulverized fuel and fuel oil for steam-locomotive purposes, it may be stated that with pulverized coal at 13,750 B.t.u., costing \$2.35 per ton, and fuel oil at 19,500 B.t.u., costing \$2.75 per hundred gallons, an amount of at least \$2.50 must be expended for the fuel oil necessary to perform the same useful work as will obtain from \$1.00 expended for pulverized fuel.

The development work pertaining to the use of pulverized fuel for locomotives has been carried along in direct conjunction with the use of like fuel in one 463-hp. nominal rating Stirling type of stationary boiler, various tests being made for the purpose of determining the best combination of fuel and air admission, flame-way, and draft and furnace

construction for the maximum boiler capacity and efficiency consistent with minimum renewal of refractory materials. Both bituminous and anthracite fuels have been used, the principal work being in connection with the latter on account of the greater difficulty in maintaining combustion due to the low volatile content.

In general, it may be stated that the use of pulverized anthracite slush will double the steam-generating capacity of boilers now burning bird-eye anthracite hand-fired on grates, and at the same time eliminate fire cleaning, greatly decrease the amount of ash to be handled, and reduce the boiler-plant labor cost about 40 per cent. Furthermore, with the pulverized fuel, the boiler pressure can be more readily maintained or increased or reduced to meet the requirements and when one or more of the boilers are not needed temporarily, the fuel feed can be stopped and started at will, thereby eliminating the necessity for maintaining banked fires and burning fuel when not required in order to have the boilers ready for instant use.

An investigation of the culm banks in the anthracite-coal-mining district would undoubtedly disclose many millions of tons of domestic and steam sizes of fuel that can be reclaimed, and in addition, the large percentage of slush that would be produced in this process could all be utilized in pulverized form for power-generating purposes.

Steam locomotives of the future, on account of track, bridge, tunnel and overhead clearance limitations, will be required to produce the maximum possible hauling capacity per unit of total weight. As the cylinder horsepower available is entirely dependent upon the boiler horsepower and temperature of superheated steam produced, the use of pulverized fuel to increase the heat value per cubic foot of firebox volume and provide a higher average and more uniform firebox temperature in combination with a reduced front-end or waste-heat temperature, appears to be the most logical means for the solution of the problem.

DISCUSSION

W. L. Robinson, supervisor of fuel consumption, Baltimore & Ohio, in discussing Mr. Muhlfeld's paper, called attention to the effect which the car shortage had in impairing the regularity of the supply of coal of the proper grades for use in passenger and stoker-fired freight service. On account of the irregularity of the supply it has been necessary to put lump coal on stoker-fired locomotives and in some cases to put slack coal on passenger locomotives. With the general use of pulverized fuel, all locomotives using the same class of coal, the minimum interference with the coal supply resulting from car shortages would be produced. He also referred to the effect on the cost of operation which is being produced by the continually increasing price of the commercial grades of coal. Referring to Mr. Muhlfeld's statement that \$75,000,000 to \$100,000,000 of the \$300,000,000 expended annually for fuel is accounted for by stand-by losses, he stated that results of some dynamometer tests on the Baltimore & Ohio almost exactly checked with this statement, only about 66 per cent of the total amount of coal purchased being used in actually hauling trains.

From a conducting transportation standpoint Mr. Robinson considered one of the biggest advantages in the use of pulverized coal to be the possibility of reducing delays at terminals. Another point emphasized by Mr. Robinson was the ability of the fireman to check the engineer on signal indications, because with pulverized fuel it is unnecessary for him to leave the seat box.

C. W. Corning, chief service inspector, Chicago & North Western.—Discussing this subject from the viewpoint of a locomotive engineman, of the many things which contribute toward the lightening of his cares in the discharge of his duties, probably the two most essential conditions are properly working injectors and the free steaming of the engine.

In all the runs made by the Chicago & North Western Atlantic type locomotive equipped for burning pulverized fuel, it has never failed to deliver all the steam required. A locomotive is often operated in accordance with the fireman's physical endurance. On one occasion, through no fault of the engine or train, there was a delay of several minutes, at which time it was noted by the engineer that provided he could maintain a certain speed over the last 25 miles of the trip, the train would be brought to the terminal on time. This was accomplished and the steam pressure never varied more than two pounds under the maximum. Under the same conditions it would have been impossible to have obtained the same results had the engine been hand-fired, as it would have been beyond human endurance to have maintained the steam pressure required.

Another feature which impresses itself on the mind of the engineer is that in the event of the failure of the injector it is a simple matter to shut off the supply of fuel until the difficulty can be remedied and the fire relighted and very often it is unnecessary even to stop. On the other hand, should it become necessary to draw the fire in one of our modern locomotives, it would be practically an impossibility and an attempt either to extinguish or deaden the fire would mean a very serious engine failure.

The draft appliances, when once adjusted on a pulverized fuel burning locomotive need not be changed to meet conditions necessary to burn different grades of fuel, or to meet changes in climatic conditions. It is the practice at this time of year to change drafting appliances to produce a stronger draft in order to overcome the frozen moisture in the fuel.

J. H. Manning, superintendent of motive power, Delaware & Hudson.—The Delaware & Hudson, located in the anthracite coal fields of Pennsylvania, closely connected with a territory that produces about 80,000,000 tons of anthracite coal per year, it is not hard to understand that from the time this coal is put in the mine car to proceed to the breaker and there be prepared for the market, with a size that starts probably with 12-in. irregular lumps and ends with birdseye, a great deal of extremely fine coal and dust accumulates in the process. This cannot be burnt on the grates; but, if at all, in suspension in a refractory furnace. For this purpose there is available in our neighborhood 550,000 tons a month. This latter and the fact that there were located around us a number of industrial plants successfully burning bituminous coal in pulverized form, encouraged us to build an experimental locomotive producing approximately 2,700 cylinder horsepower.

We soon found out it would be impossible to burn clear anthracite coal in pulverized form. Due to the low volatile, it would promptly snuff out if the engine slipped or worked extremely hard, and the firebox temperature would not permit it to again flash. We, therefore, determined to start with 75 per cent bituminous and decrease until it was found that the objectionable feature was removed. This continued until a mixture of 60 per cent anthracite and 40 per cent bituminous was obtained. We find this gives splendid results, the engine steams freely with very little smoke and is very nicely controlled by the fireman to the extent of keeping the engine within three pounds of the maximum pressure continuously without popping under the different operations necessarily obtaining in a day's work with an engine of this character, and we have experienced no firebox trouble whatever.

Such difficulty as we have had with the pulverized fuel mechanism for the introduction of the fuel into the firebox has been satisfactorily eliminated and the successful burning of pulverized fuel in suspension in locomotive fireboxes, to my mind, has passed beyond the experimental stage.

S. S. Riegel, mechanical engineer, Delaware, Lackawanna & Western.—The paper inspires the belief that the initial work has been well done along correct lines. In the use of an induced draft for the secondary air of combustion lies

possibly its greatest assurance of success, as this overcomes (properly applied) the destructive heat action of the fuel jets against the brick work of the combustion chamber and furnace linings, and at the same time furnishes a convenient way to secure the necessary air for combustion with the effort required to remove the ashy deposits from the heating surfaces and front end of the locomotive.

It is particularly interesting to find that a satisfactory system of utilizing pulverized fuel in locomotive service so easily adapts itself to locomotive conditions, as a locomotive must operate on such greatly varying conditions, and always in doing the maximum work on an intensive draft condition. From the viewpoint of the possibility of overcoming the standby and firing up losses of the locomotives, powdered coal is given an opportunity which is not possible in stationary practice. As the author states, the standby losses may constitute from one-fourth to one-third of the total fuel consumption, and it is obvious the opportunity for reducing these losses is very great.

Likewise, as it is necessary to separate the fuel particles and surround them with sufficient air for perfect combustion, it would seem equally desirable to separate the particles of the crushed materials in the drying process, and the most effective dryer would be the one which best effected this separation of the particles of fuel. The burden of about 40 cents per ton in the present method is a large handicap and it must be reduced as much as possible.

George L. Fowler referred to some tests which he has made to determine the movement of firebox sheets in service, which showed the extreme sensitiveness of the sheets to changes in temperature. The opening of the firedoor was found to cause a drop in temperature of the adjacent sheets of about 250 deg. F. in 15 sec. He pointed out that in burning pulverized coal, the firebox sheets may be maintained at a much more uniform temperature, with a reduction in the stresses produced by sudden temperature changes.

C. D. Young, engineer of tests, Pennsylvania Railroad, said that in some tests made on a locomotive-type boiler in stationary service, the greatest difficulty was to prevent the destruction of the brickwork when burning coal in the quantities used in road service, and that when the temperature of the firebox is reduced to overcome this difficulty by the use of excess air, the efficiency of the combustion is reduced. He also called attention to the fact that the Chicago & North Western Atlantic type locomotive is a light locomotive and was lightly loaded in the test runs; and that under the same conditions with proper supervision, hand-firing would have produced smokeless operation. He also pointed out that the performance of this locomotive was very poor, probably being accounted for by the water rate, which was 56 lb. per indicated horsepower, whereas, a fair figure would be 20 lb. to 21 lb. Allowing for the excessive water rate the fuel performance was about what might be expected with hand-firing.

Charles W. Baker, editor of the Engineering News, emphasized the economic importance of the development of pulverized fuel. He considered the point of immediate interest, however, the possibility of using pulverized fuel in switching service as a means of smoke elimination in cities.

G. M. Basford, president, Locomotive Feed Water Heater Company.—There are in this paper two or three points worthy of deep consideration. It is becoming evident that the real engineering development of the steam locomotive is just beginning. Possibilities of securing from every unit of firebox volume an increased amount of combustion have superseded the kind of locomotive design that runs merely to weight. In passenger locomotives there has been a tendency toward the Pacific type, yet with the large number of Atlantic type locomotives in the country, there is but one road that has even approached the full realization of their hauling capacity. Powdered fuel will make it possible for this type to take the place of the Pacific type for some years.

EXAMPLES OF RECENT LOCOMOTIVES OF THE MOUNTAIN, PACIFIC AND TEN-WHEEL TYPES

ARRANGED IN ORDER OF TOTAL WEIGHT

Table with columns for Type, Name of road, Road number or class, Builder, When built, Tractive effort, lb., Weight, total, lb., Weight on drivers, lb., Weight on leading truck, lb., Weight on trailing truck, lb., Weight of tender, loaded, lb., Wheel base, driving, ft. & in., Wheel base, total engine, ft. & in., Wheel base, engine and tender, ft. & in., Diameter of drivers, in., Cylinders, number, Cylinders, diameter, in., Cylinders, stroke, in., Valve gear, type, Steam pressure, lb., Boiler, type, Boiler, smallest outside diameter, in., Tubes, number and diameter in inches, Flues, number and diameter in inches, Length of tubes and flues, ft. & in., Heating surface, tubes and flues, sq. ft., Heating surface, firebox, sq. ft., Heating surface, total, sq. ft., Heating surface, superheater, sq. ft., Heating surface, equivalent, sq. ft., Grate area, sq. ft., Firebox, length, in., Firebox, width, in., Kind of fuel, Tender, fuel capacity, tons or gallons, Weight on drivers ÷ tractive effort, Total weight ÷ tractive effort, Tractive effort × diam. drivers ÷ equiv. heat heating surface, Equiv. heat heating surface ÷ grate area, Firebox heating surface ÷ equivalent heating surface, per cent., Weight on drivers ÷ equiv. heat surface, Total weight ÷ equiv. heat surface, Volume both cylinders, Equiv. heat surface ÷ vol. cylinders, Grate area ÷ vol. cylinders, Reference to photographs, drawings or description

* Equivalent heating surface = total evaporative heating surface + 1.5 times the superheating surface. † Includes arch tube heating surface. ‡ Railway Age Gazette, Mechanical Edition.

EXAMPLES OF RECENT LOCOMOTIVES OF THE SANTA FE AND CONSOLIDATION TYPES

ARRANGED IN ORDER OF TOTAL WEIGHT

Table with columns for Name of road, Road number or class, Builder, When built, and various technical specifications (Tractive effort, Weight, etc.) for Santa Fe and Consolidation locomotives.

* Equivalent heating surface = total evaporative heating surface + 1.5 times the superheating surface. † Includes arch tube heating surface. ‡ Railway Age Gazette, Mechanical Edition.

EXAMPLES OF RECENT SWITCHING LOCOMOTIVES OF THE 0-6-0 AND 0-8-0 TYPES

ARRANGED IN ORDER OF TOTAL WEIGHT

Type	0-8-0	0-8-0	0-8-0	0-8-0	0-8-0	0-6-0	0-6-0	0-6-0	0-6-0	0-6-0	0-6-0	0-6-0					
Name of road	N. Y. C.	N. Y. C.	Wash.	La. & N. E.	L. & N. E.	Buffalo	Birm.	T. R. R. A.	N. Y. C.	I. C.	Penn.	M. Cent.	C. R. I. & P.	K. C. S.	Union	A. S. T. P.	
Road number or class	4299	49,500	49,600	53,200	49,000	44,500	45,300	15,500	33,140	34,400	36,092	37,000	32,950	34,300	34,300	31,200	35,000
Builder	Baldwin	Baldwin	Baldwin	Baldwin	Baldwin	Baldwin	Baldwin	Amer.	Amer.	Amer.	Amer.	Amer.	Amer.	Amer.	Amer.	Amer.	Amer.
When built	1914	1914	1915	1915	1915	1915	1915	1916	1916	1915	1915	1915	1915	1915	1915	1915	1915
Tractive effort, lb.	49,500	49,500	49,600	53,200	49,000	44,500	45,300	15,500	33,140	34,400	36,092	37,000	32,950	34,300	34,300	31,200	35,000
Weight, total, lb.	240,000	239,500	229,000	225,100	216,000	207,850	206,000	206,000	172,000	169,000	168,100	165,000	162,000	158,000	156,300	151,000	148,200
Weight on drivers, lb.	240,000	239,500	229,000	225,100	216,000	207,850	206,000	198,000	172,000	169,000	168,100	165,000	162,000	158,000	156,300	151,000	148,200
Wheel base, driving, ft. & in.	16-0	16-0	15-6	15-0	15-6	14-3	14-6	12-0	11-6	11-8	11-6	11-6	11-0	11-6	11-0	11-6	11-0
Wheel base, total engine, ft. & in.	53-8½	53-8½	57-3	49-5	50-7½	49-8	47-9½	47-1½	42-7	44-2	48-6¼	48-7¾	42-6	44-2	42-2	43-8	44-1¼
Wheel base, engine and tender, ft. & in.	58	58	51	55	57	50	51	51	57	51	56	51	52	50	51	51	51
Diameter of drivers, in.	2	2	2	2	2	2	2	2	2	2	2	2	2	2	2	2	2
Cylinders, number	2	2	2	2	2	2	2	2	2	2	2	2	2	2	2	2	2
Cylinders, diameter, in.	25	24	25	24	24	22	22	22½	21	21	22	21	20	20	21	20	21
Cylinders, stroke, in.	30	30	28	30	30	28	28	30	28	26	24	28	28	28	26	26	26
Valve gear, type	Wals.	Wals.	Baker	Wals.	Wals.	Wals.	Wals.	Wals.	Wals.	Wals.	Steph.	Wals.	Baker	Wals.	Wals.	Wals.	Wals.
Steam pressure, lb.	180	180	185	180	190	200	200	180	180	180	180	180	180	180	180	180	185
Boiler, type	E. W. T.	E. W. T.	W. T.	W. T.	W. T.	W. T.	W. T.	W. T.	W. T.	W. T.	W. T.	W. T.	W. T.	W. T.	W. T.	W. T.	W. T.
Boiler, smallest outside diameter, in.	72½	72½	78	74½	74	74½	80	80	67½	66½	68½	66	63½	62	70	65	68
Boiler, number and diameter in inches	214-2	214-2	184-2½	450-2	214-2	177-2	234-2	440-2	230	165-2	163-2	323-2	163-2	151-2	172-2	168	171-2
Flues, number and diameter in inches	30-5½	30-5½	34-5½	32-5½	32-5½	26-5½	30-5½	30-5½	28-5½	22-5½	21-5½	22-5½	21-5½	22-5½	28-5½	26-5½	24-5½
Length of tubes and flues, ft. & in.	16-6	16-6	14-9½	15-0	14-9½	11-4	15-0	15-0	14-6	16-0	13	11½	16-0	16-0	11-6	11-0	11-6
Heating surface, tubes and flues, sq. ft.	204	204	213	214	216	220	189	170	191	142	154	152	139	127	145	140	178.4
Heating surface, total, sq. ft.	2,548	2,547	2,314	3,515	2,310	1,854	2,394	3,436	2,317	1,879	1,695	2,342	1,862	1,739	1,381	1,478	1,367.6
Heating surface, superheater, sq. ft.	580	570	720	547	443	523	460	380	360	403	380	310	362	311.2
Grate area, sq. ft.	3,330	3,330	3,607	3,729	3,337	2,738	3,368	3,606	3,198	2,591	2,389	2,494	2,605	2,436	1,991	2,161	2,012
Firebox length, in.	102	102	120	120	126	96	96	84	72	86	90	84	84	84	84	108½
Kind of fuel	Bit. coal	Bit. coal	Bit. coal	Bit. coal	Bit. coal	Bit. coal	Bit. coal	Bit. coal	Bit. coal	Bit. coal	Bit. coal	Bit. coal	Bit. coal	Bit. coal	Bit. coal	Bit. coal	Bit. coal
Tender, fuel capacity, tons or gallons	7,500	7,500	10,000	7,000	7,400	8,000	5,500	5,000	7,000	5,100	5,000	5,500	6,000	5,000	4,500	5,000	6,000
Weight on drivers ÷ tractive effort	4.85	4.8	4.62	4.32	4.41	4.7	4.56	4.51	4.35	5.19	4.91	4.65	4.5	4.61	4.61	4.54	4.8
Total weight ÷ tractive effort	4.85	4.8	4.62	4.32	4.41	4.7	4.56	4.51	4.35	5.19	4.91	4.65	4.5	4.61	4.61	4.54	4.8
Tractive effort × diam. drivers ÷ equivalent heating surface*	792.6	862.2	701.3	770	837.1	813.0	684.5	639.3	725.6	729.0	734.3	810.4	725.0	703.5	861.3	791.0	880.0
Equivalent heating surface ÷ grate area	67.95	62.5	65.58	69	66.45	28.8	70.89	75.12	77.81	79.47	55.55	60.46	79.8	76.84	47.4	54.4	62.2
Firebox heating surface ÷ equivalent heating surface*, per cent.	4.94	6.1	5.30	5.74	5.72	8.0	4.96	4.71	5.47	4.98	5.83	6.09	5.3	4.68	7.28	6.48	8.8
Weight on drivers ÷ equiv. heat. surface	66.26	72.0	63.48	60.4	64.72	76.0	61.17	54.35	61.91	66.38	70.74	67.40	63.5	66.5	79.35	72.33	75.2
Total weight ÷ equiv. heat. surface	17.04	17.1	14.66	17.04	15.71	12.2	13.8	12.31	13.8	11.22	10.42	10.56	11.2	10.18	10.18	10.40	9.5
Volume both cylinders	212.55	195.0	246.04	218.7	212.38	224.0	273.55	292.93	231.73	230.92	229.27	286.17	332.0	239.29	207.8	212.0	194.9
Equiv. heat. surface ÷ vol. cylinders	3.13	3.1	3.75	3.17	3.20	7.8	3.86	3.90	2.98	2.91	4.13	3.90	3.11	4.13	3.81	3.81	3.3
Grate area ÷ vol. cylinders

*Equivalent heating surface = total evaporating heating surface + 1.5 times superheater heating surface
 †Includes arch tubes.

Car Department

PRACTICAL TESTS OF FREIGHT CAR PAINT

BY G. S. EVANS

Few American car builders are provided with sufficient roofage to allow of using any but very rapidly drying paints, and consequently the drying quality with its resultant finish forms a prime factor in the selection of the particular brand of paint to use. However, an equally important factor and one which is seldom given the consideration which it merits, is the covering quality, i. e., the amount of paint required to produce the desired finish, and otherwise meet the

very thin cover glass over it and gently rub the two glasses together until all surplus paint is forced from under the cover glass so that it rests on the pigment particles, as indicated by a grating sensation, after which the slide is examined under the microscope, using transmitted light. It requires a little practice to prepare specimens of the proper density to indicate the true nature of the pigment, but after some practice this method becomes exceedingly simple to one familiar with the use of the microscope.

Examples of this method of determining the fineness of this class of pigments are shown in Figs. 1, 2 and 3, which are micrographs, magnified 150 diameters, representing three different brands of No. 21 paint used in the practical painting tests, the results of which are given elsewhere in this paper. In these, the dark areas, some of which are designated by a circle, represent individual pigment particles. Some of the larger particles in Figs. 2 and 3 are transparent silicious material, as indicated by the white or grayish area in the centers of each. As seen in the micrographs the size of the particles varies quite considerably between Fig. 1 and Figs. 2 and 3, Fig. 3 being slightly coarser than Fig. 2. Incidentally the relative covering value decreases very markedly

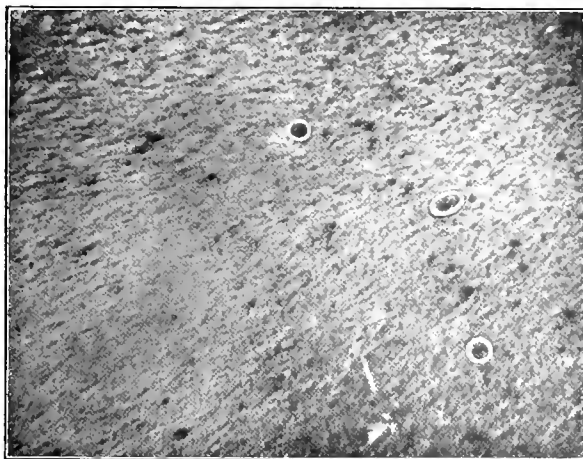

Fig. 1—Micrograph Showing Character of Pigment Particles of Brand No. 1 Magnified 150 Diameters

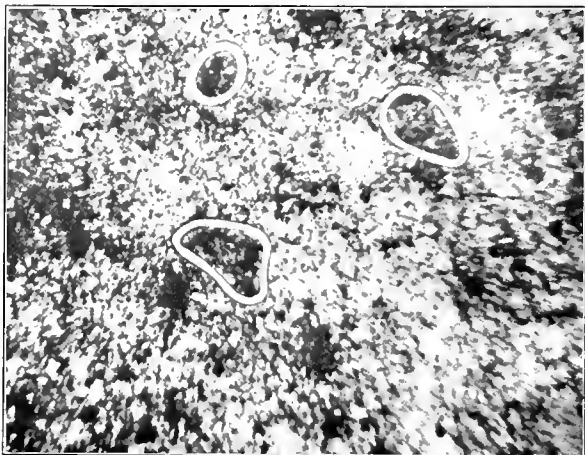

Fig. 2—Micrograph Showing Character of Pigment Particles of Brand No. 2 Magnified 150 Diameters

purchasers' specifications per square foot of painted surface. Many freight car paints stand on an equal basis as regards application, drying and finish and the selection of the economical paint is determined by the covering quality.

The covering value of all paints depends primarily upon the character of the pigment, the factors influencing this being the nature or chemical composition, and the physical composition or the shape and size of the minute individual particles. The latter is the determining factor between paints of like chemical composition.

There are several methods of determining the relative covering value of different iron oxide pigments. One which is pretty generally used for testing this quality, and also the shade of No. 21 Oxide Red freight car paint is to mix the dry pigment with a definite proportion of pure raw linseed oil, place a few drops on a clean, plain glass surface which is allowed to remain in a vertical position for one or two hours, after which the coating remaining on the glass is compared with a coating prepared in like manner from a standard sample. This is a very simple method and gives fairly good comparative results.

Another method is to place a drop of the mixed paint, as used in the preceding method, upon a slide glass, place a

between Figs. 1 and 2 and slightly between Figs. 2 and 3, as indicated by the painting tests.

The sieve test, which is based upon the per cent of the pigment which will pass through a sieve of a specified mesh is a very satisfactory method for testing the dry pigment before having been ground in oil, but is difficult to use in testing mixed paint or paste, as it requires a complete separation of the oil and pigment, which is rather tedious.

Another simple test, which though particularly indicative of the specific gravity also gives an idea of the relative fineness of the particles, is the settling test, which is made by allowing samples of the mixed paint to remain quiet for a specified time and noting the rate of precipitation.

The only reliable test by which the covering value of paints

can accurately be ascertained and their relative value computed in cost figures is the practical painting test. The practical tests described herein were made with the three brands of No. 21 paint illustrated in the micrographs. This material is purchased in a semi-paste form and is mixed with oil and drier in varying proportions for the first, second and third coatings, depending upon the quality of the pigment. On account of the differences in the covering and drying qualities of the pigments, it was found that the same proportions of oil and drier could not be used with the different brands. This necessitated considerable experimenting with different mixtures in order to obtain first, second and third coatings of each which would meet our requirements as to the drying quality and resultant finish. So far as it was possible to determine, each of the mixtures shown in Table I,

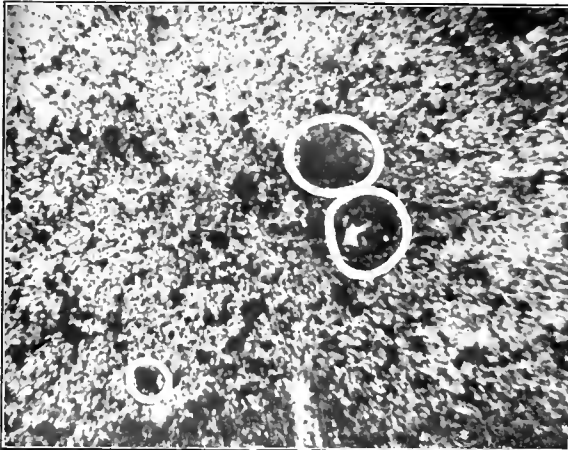

Fig. 3.—Micrograph Showing Character of Pigment Particles of Brand No. 3 Magnified 150 Diameters

represented the cheapest mixture of that particular brand which would give the proper finish.

TABLE I.—COMPOSITION OF THE MIXED PAINTS.

	Brand No. 1.	Brand No. 2.	Brand No. 3.
First Coating—			
Paste	28.7 lb.	34.5 lb.	34.1 lb.
Linseed oil	26.1 lb.	21.8 lb.	22.0 lb.
Drier	45.2 lb.	43.7 lb.	43.9 lb.
Cost per 100 lb.	100.0 lb. \$5.96	100.0 lb. \$5.57	100.0 lb. \$5.55
Second Coating—			
Paste	38.2 lb.	43.0 lb.	42.7 lb.
Linseed oil	22.3 lb.	18.9 lb.	19.0 lb.
Drier	39.4 lb.	38.1 lb.	35.3 lb.
Cost per 100 lb.	100.0 lb. \$5.48	100.0 lb. \$5.22	100.0 lb. \$5.23
Third Coating—			
Paste	41.9 lb.	50.5 lb.	50.0 lb.
Linseed oil	21.2 lb.	16.2 lb.	16.4 lb.
Drier	36.9 lb.	33.3 lb.	33.6 lb.
Cost per 100 lb.	100.0 lb. \$3.35	100.0 lb. \$4.94	100.0 lb. \$4.96
Paste, No. 21 Freight Car Red, 16 lb. per gal., figured @ 50c. gal.			
Linseed oil, 7.6 lb. per gal., figured @ 75c. gal.			
Drier, Dithanol, 6.6 lb. per gal., figured @ 35c. gal.			

The tests were made on 36-ft. ventilated box cars by painting three cars with paint made from each brand of the No. 21 paste, recording the number of pounds of mixed paint required for each of the three coatings and taking the average of the three in each case as representative of that brand. The paint was applied with a brush, by the same man in all cases and under as nearly like conditions as were possible to obtain, so as to avoid any discrepancies from this source.

Comparing the mixtures shown in Table I, it will be noted that pigment No. 1 required relatively less paste and more linseed oil and drier than Nos. 2 and 3 in order to make a mixed paint of like covering and drying qualities, which made the mixed paint cost more per 100 lb. than either of the other brands. However, this spread very much better

than either of the latter and, consequently, required less per car as shown in Table II, which made this the most economical mixture.

TABLE II.—AMOUNT OF PAINT PER CAR, AND COST

	Brand No. 1.	Brand No. 2.	Brand No. 3.
First Coating—			
Lb. of mixed paint applied	28.7 lb.	32.6 lb.	33.1 lb.
Cost per car	\$1.71	\$1.82	\$1.84
Second Coating—			
Lb. of mixed paint applied	24.3 lb.	28.5 lb.	31.6 lb.
Cost per car	\$1.33	\$1.58	\$1.65
Third Coating—			
Lb. of mixed paint applied	21.1 lb.	26.2 lb.	29.1 lb.
Cost per car	\$1.13	\$1.29	\$1.44
Total number of lb. applied	74.1 lb.	87.3 lb.	93.8 lb.
Total cost of three coatings	\$4.17	\$4.69	\$4.93
Excess cost of No. 2 over No. 1		\$0.52 per car	
Excess cost of No. 3 over No. 1		\$0.73 per car	
Excess cost of No. 3 over No. 2		\$0.24 per car	

Comparing the cost figures shown in Table No. 2 it will be noted that the average cost of cars painted with pigment No. 1 is \$4.17 each, as against \$4.69 and \$4.93, each painted with Nos. 2 and 3, respectively. There is also considerable difference in the labor both in handling the excess material and in its application, especially when applied with a brush, besides the difference in the life of a brush.

While these tests were made primarily for the purpose of determining the relative value of each as a coverer, test boards were painted with each and exposed to the weather in order to determine differences, if any, in the relative value of each as preservatives, or the life of the paint. These have been examined periodically now for over two years, but no appreciable differences are discernible.

Chemical analysis of each of the three different brands indicated that their composition was very similar, which with the foregoing tests leads us to the conclusion that the wide differences in the covering quality, as indicated by the painting tests, is a result largely of the size of the pigment particles and indicates the necessity of thorough pulverization of the pigment.

INTERCHANGE INSPECTION*

BY J. J. GAINNEY
C. N. O. & T. P.

In discussing the rules if we would consider the different conditions of a car and describe what is a safe condition to be run we would be able to accomplish a great saving for the roads we represent. Say, for instance, a car with worn sills, which is one of the most numerous defects with which the railroads have to contend. In some parts of the country a car will be condemned for this defect, regardless of its construction. There are a great many cars, having short draft members running back to the body bolsters with no shoulder against the end sill and no timber keys, which have to depend entirely upon the draft bolts to stand the strain. It must be admitted that this condition is quite different from a car that has short draft members with a $\frac{1}{2}$ -in. to $2\frac{1}{2}$ -in. shoulder against the end sill, or a draft casting with a shoulder of 3 in. against the end sill. With a good shoulder against the end sill there is very little danger of the draft timbers pulling out.

This and other similar subjects should be thoroughly discussed by this association, and undoubtedly we could arrive at some definite conclusion in saying what cars are safe to run. You are all well aware of the large amount of money expended each year for transferring loads, and this is not the only expense, for, as a general rule, when the freight arrives at its destination in a different car from the one it was originally loaded in, a claim is presented for damages by the shippers. By clearer understanding and one universally followed we will be in a position to save a great many cars from transfer by the intermediate line.

*A paper presented at the convention of the Chief Interchange Car Inspectors' and Car Foremen's Association held in Indianapolis, Ind., October 3-5, 1916.

HOT BOX PROBLEM NOT INSURMOUNTABLE

Enthusiastic Educational Campaign Reaching Every Man Would Practically Eliminate the Trouble

FEW competitions have drawn out as many letters as the one which was recently held on the Freight Car Hot Box Problem, an announcement concerning the winners of which is made in our editorial columns. The letters submitted discuss the subject from many viewpoints, some going more or less thoroughly into the detail causes and how they may be remedied, and others attacking the problem from a broader viewpoint looking toward the solution of the problem in a big way. A few of the contributions follow. A number of others will appear in subsequent issues.

"WASTE DRAG" THE PRINCIPAL EVIL (PRIZE ARTICLE)

By A. M. DOW

Foreman, Freight Car Repairs, El Paso & Southwestern, El Paso, Tex.

It is surprising how many men will contend that because the journal was not swimming in oil, "of course it ran hot."

Again we hear men claiming that the last lot of brasses had hard crystallized spots in them; in fact, will take a brass that has been removed from a hot box and show you a bright hard looking spot, calling it a "hard spot" in the brass. It is, and was caused by our old friend "Waste Drag"—a thread of waste feeding under the brass and setting up a frictional heat. If it is caught in time and the brass removed, the brass will show the hard bright spot; if not caught in time a cut journal will result. The remedy is an intelligent oiler; not with an oil can but with a packing knife with which he works the waste up against the journal from the bottom of the box and then carefully puts it down with his knife on both sides of the journal to a point slightly below the center line of the journal and the full length of the oil box. Then, if the waste is found dry, a small quantity of oil may be poured over it on the "rising" side of the journal. It is safe to say that there is enough oil in any oil box in which the waste is still elastic and not dead to run the car from Chicago to San Francisco, if handled intelligently at each division enroute and of course barring worn out brasses.

There are but four legitimate causes of hot boxes. The "waste drag" heads the list by an immense majority and is caused by the waste being allowed to climb on the rising side of the journal and crowd against the brass until a jar or application of the brakes permits a small opening between the brass and journal into which a thread of waste feeds and the trouble is started. A preventive for this is an intelligent use of the packing iron in keeping the waste in its proper place at each and every division point, as stated above.

The second cause, and of secondary importance, is a worn out brass. Now that shell brasses have become almost obsolete these are becoming more and more of a rarity and are due to poor judgment on part of inspectors in allowing brasses to run beyond a safe point.

The third, or cause of least importance according to my observation, is lack of oil. This cause is rarely met with, but is put forth by trainmen and some mechanical men as a cause of most hot boxes, and strange to say, is accepted in many quarters as true. A careful analysis of causes of hot boxes before the journals are cut or the waste is burned out of the box will in almost every case show enough oil in the waste to run the car almost anywhere.

The fourth cause is brasses whose contour does not fit that of the journal. This rarely causes bad hot boxes but frequently causes them to run warm. The remedy for this is obvious.

The inspection points having the least hot boxes charge-

able to them, will upon investigation be found to be the ones that have their oilers equipped with good packing knives and the knowledge of how to use them to the best advantage, and not those who use the most oil.

ENTIRELY AN EDUCATIONAL PROBLEM

(PRIZE ARTICLE)

By J. S. BREYER

Master Mechanic, Southern Railway, Charleston, S. C.

Hot boxes can be reduced to the minimum by properly assembling the parts of the car closely related to the box and caring for them in a workmanlike manner after the cars are placed in service. To bring about this improvement it is necessary to pursue the same course we took to promote the "Safety First" movement which has resulted in such a decided decrease in the number of personal injuries, i. e., to educate the men doing and supervising this work. We are producing better mechanics and more efficient foremen as a result of our apprentice schools, but our car repairers and oilers are in greater need of education. Let them understand what causes hot boxes and what is necessary to prevent them; this many of them do not know. The railroads in the past 20 years have used enough lubricants to run them at least 10 years more had it been intelligently applied.

Start the educational campaign with the operator of the axle turning machine; the finishing cut over the journal should cut the metal clean and not tear it. If the metal is torn small particles are rolled down only to be loosened up when the axle is put in service. This acts as a saw on the soft lining of the bearing. If the axle is not used at once rust forms on the journal, and if not painted the small cavities where the metal is turned will be attacked by rust and enlarged. To remove the rust sand paper or emery cloth is ordinarily used and, unless great care is exercised, some of the emery that becomes separated from the sheets will lodge in these cavities. Even when the journals are painted immediately after machining, the paint is often removed with emery cloth and particles of grit are left partly imbedded in the journals. Such a condition will very likely cause or contribute to the box heating the first trip. In my opinion many of the hot boxes that occur several days after the wheels are applied are caused by torn or pitted metal and the other conditions described above.

Another dangerous condition is caused by scars from bars used for moving wheels, or where one wheel has struck the journal of another; these burrs are sure to cause the box to heat and they are frequently overlooked by experienced men, if they are on the under side when the polishing of the journal is completed. To guard against this oversight, the bare hand should be wiped over the entire surface just before applying the bearing and box.

The bearing should be fitted to the contour of the journal, or at least it should have a crown bearing. If it bears on the sides only it pinches the journal and there is danger of breaking the bearing before the soft metal wears down. The journal box and float should be renewed if worn to the extent that the weight will be unevenly distributed on the bearing.

Bent arch bars, broken spring planks, bolsters, defective center plates and side bearings also contribute extensively to the hot boxes.

Long fibre wool waste is best for packing; this should be soaked in car oil 48 hours; then wring out all the oil you can with the hands. One handful twisted like a rope should be

placed in the back of the box; this forms a dustguard. Then fill the box to the center line as far out as the collar with spongy waste, not packed too tight; another handful of twisted dope should be placed in front of the journal; this will partly prevent the lateral motion of the truck working the packing out, leaving the back end dry. At every division terminal the packing should be pushed back and stirred up with the packing knife. This will also keep the oil feeding to the end of each strand of waste. Loose ends of waste must not be left hanging from the box; they will siphon the oil out in a short time, especially when the sun is shining on the box. Packing above the center line of the journal will creep under the bearing when the car receives severe shocks in switching service; this causes hard spots in the bearing and will surely cause the box to heat. Excessive oil means insufficient waste; the waste settles below the journals and the oil runs out through the dustguard opening, leaving the journal without lubrication.

SYSTEMATIC AND THOROUGH ATTENTION

(PRIZE ARTICLE)

BY J. E. HELMS

Inspector, Atchison, Topeka & Santa Fe Shops, Pueblo, Colo.

Many pages of advice have been published from every source imaginable concerning a remedy for hot boxes, each in turn suggesting some positive cure. Suggestions from every quarter—some good and some bad—have been offered and put into practice; and all, or nearly all, have failed. Messages galore from those in authority have been received by their subordinates asking for explanations of why such and such cars could not have been put into shape to avoid trouble on the road. The experienced subordinate has labored incessantly to alleviate the trouble. The inexperienced man has labored and labored, used up all the material that was at hand, did the best he could, and quit his position in disgust.

There have been at least "57 varieties" of "packing," "lubricants" and "babbitts" developed and tried out, the majority of which could not be successfully used and the old substantial wool packing and oil has taken their places.

Many special designs of journal boxes and parts have been devised but these have accomplished little if any results.

Thus through a course of practical experience of 15 years I have seen many of the above "cure-alls" fail. Trains are still running and boxes are still getting hot. The following suggestions may help in a measure to reduce the hot boxes to a minimum but never to eliminate them entirely, for with present weights, speeds and unforeseen defects we can never hope to do this.

Much of the trouble could be gotten away from by a standard and uniform manner of packing the boxes, such, for instance, as the following: Roll up a large handful of waste and place it in the back of the box; then pack the remainder of the box half way up the side of the journal with a handful of packing; do not roll so tightly that the life or spring in the wool fibre will not rise up against the journal. One large handful of packing should be placed in front of the box and at the end of the journal. This wool fibre should hold all the oil it can take.

All boxes reaching the shop tracks should be gone over thoroughly by an experienced man; not one shop should do this, but all shops, and to all cars. This system installed and lived up to would do more than any other one thing to reduce the hot-boxes. Many roads do no shop work at all to the journal boxes, not even to their own cars. With so important a part neglected it is not much wonder that hot-boxes are numerous. The M. C. B. Code, Rule I,—and it is a number one rule, too, if it was enforced—explicitly states, "that each railway company must give to foreign cars, while on its line, the same care as to inspection, oiling, packing, etc., as it gives to its own cars."

You will note that this says "must," not "should," using

a positive term, and yet the work is woefully neglected much of the time. This rule, if lived up to, would in a short time bring a noticeable relief in the complaints about hot-boxes.

After a rule regulating and causing this work to be done in a systematic manner, the following matters should be considered: Speed of trains and time card "speed limits." The "average speed" of freight trains could be adjusted in many instances, taking into consideration tonnage, meeting points and class of cars and much trouble could be avoided.

Weight of loads on journal bearings has been re-adjusted to a large degree in the enlarging of the journal, thus giving a larger bearing for the brass and more room for lubrication.

UNIVERSAL STANDARD PRACTICES ADVOCATED

BY "A CAR MAN"

Each box should be given careful attention in assembling and maintenance. By careful attention is meant that which would be given any other piece of machinery from which such severe or even less exacting service is required. When assembling, presuming that the trucks are of good design, we should see that the inside dimensions of the journal boxes are correct with no imperfections which will interfere with the freedom or functions of the wedge and brass, and that a good serviceable dustguard is properly applied. By serviceable is meant one which will exclude dust until the wheels are again changed. To do so it must properly fit the axle and be perfectly free in the box recess so that shifting of journal and wear of the brass will not affect it. A canvas covered basswood guard is good if properly applied, and worthless if not.

Any good dust-tight lid provides the protection required at the front of the box but it should not be too difficult to open. Each brass and wedge should be inspected and gaged on receipt from the manufacturers and any found with defects or with irregularities which would displace or restrict the perfect freedom of either one or both should be rejected. The finish on newly turned journals should be good; to what extent and how obtained should be determined—whether by rolling, filing, emery polish, or only a finish cut. All these methods are in vogue and obviously all are not the best or sufficient.

Rule 1 of the M. C. B. code provides that in the interchange of cars each road shall give to foreign cars the same care as to oiling and packing that it gives to its own. This seems fair but when we consider that for present day traffic the best is none too good and knowing that on some roads an inferior grade of oil and cheap cotton waste is used, it is not surprising that some trouble is experienced; to overcome the hot box evil it is suggested that the contents of the journal box and treatment or maintenance of same be made standard. These standards should include the grade of lubricating oil—necessarily a good all-the-year-round grade with sufficient body to separate the journal and bearing under full load summer and winter. It should also include the waste, which should be absorbent, clean and resilient to a specified degree. Also the method and extent of saturation, the method of packing the box: the amount of free oil should be prescribed to be used when first packing the box and thereafter on a mileage basis. The lead lined brass of a certain composition should be prescribed and also the method of finishing newly turned journals.

FROM AN OPERATING OFFICER'S VIEWPOINT

BY H. E. HAANEL

Trainmaster, Canadian Pacific, Regina, Sask., Canada

Given a properly applied brass with homogeneous babbitt metal, and a smooth, true journal, the study of hot-box prevention resolves itself into two elemental factors, viz., satisfactory lubrication and freedom from extraneous substances on the bearing surfaces. The interruption of uniform lubrication, even for a very small space of time, increases friction

so rapidly, particularly with heavily loaded cars, that often before the trouble can be detected the babbitt metal starts to flow, causing an uneven bearing, and, with the resultant increase in heat, the lubricant becomes carbonized introducing an additional factor that tends to increase friction. The box soon bursts into flame.

It is the lack of intelligent and systematic inspection and attention that results in a condition preventing uniform lubrication. If the dope, with sufficient oil content, were continually kept in close contact with the entire exposed surface of the journal, hot-boxes would be reduced 75 per cent. For different reasons we will not discuss here, dope has a tendency to shrink away from the journal. It also frequently becomes crowded to one side of the oil box through a prolonged rotation of the journal in one direction, and, unless it is loosened up and repacked frequently and re-oiled occasionally, hot-boxes are the natural result. The perfunctory oiling of boxes at a few designated points simply wastes oil by flooding cars that happen to pass such points frequently, or that do not require oil anyway, while other cars visit such points so infrequently that their boxes run hot in the meantime. The hurried jabbing of the dope which accompanies the oiling process simply gives the final touch to an operation that impresses even the uninitiated with a sense of its inefficiency.

It is, of course, of prime importance that oil boxes have lids that are well fitted and tight and that proper fitting dust-guards be supplied and kept in condition; otherwise the introduction of sand and grit to the dope and thence to the bearing surfaces is certain to occur. The application of hard grease directly on the bearing surfaces by means of pressure grease cups might prove a success, but as long as our present contrivance is in use, a serious campaign, with a view to more efficient lubrication by the exercise of more intelligent and frequent attention to the position and condition of the dope, as well as a more wholesome regard for the importance of tight lids and suitable dust-guards, should result in hot boxes being reduced to a minimum. As it is, oil boxes are rarely given any serious thought until they start to smell, and by that time damage has been done which, while possible to counteract temporarily by fresh dope, oil, soap, hard grease or other expensive first aid treatment, will early demand earnest attention even though it be on the main line between stations.

Of course there are other factors, one of the most important of which is that of speed. The introduction of a speed limit of 30 miles an hour for Canadian Pacific freight trains has resulted in an astonishing decrease in hot-boxes.

NEGLECT!

BY F. P. ROESCH

Master Mechanic, El Paso & Southwestern, Douglas, Ariz

The cause of hot bearings on freight cars can be summed up in one word, neglect. Not intentional neglect perhaps, but neglect nevertheless.

The laws of friction are too well understood to make repetition necessary. Neither is it necessary to dwell on means and methods advocated to overcome friction in freight car journals. He who runs may read, or if he prefers can readily obtain all necessary information from any of the traveling experts representing the various lubricating companies, who lubricate under a mileage contract 99 per cent of all cars in the United States.

Experience has proven that what are termed the white metals (babbitt, etc.) are preferable as bearing metals, where the loads are not excessive, to brass or bronze. Yet in our terminal inspections how often do we look to see whether or not any of the white metal lining is present? Is it not a fact that so long as the bearing shows to be of average thickness and is not cracked or discolored it is passed as O. K.? Yet in many instances, no doubt, part or all of the white metal lining

may be so worn as to allow the brass to come in direct contact with the journal and thus produce a condition eventually resulting in a hot box.

Again, examine the packing in the average freight car journal box. Do we find "live" resilient waste, or short fibered sticky, soggy waste? The question answers itself to all who have had to do with freight cars. The addition of oil to such stuff is but a temporary relief, not a remedy. The worst offender in this respect is the car lying idle on sidings or storage tracks during temporary decline in business; it is called to service in a hurry to meet a threatened car shortage, and allowed to go forward with but a superficial oiling instead of a thorough examination and renewal of packing which may have become dried out, settled away from journal, etc.

Granting the above to be correct the remedy is self suggestive, namely a periodical inspection of the bearings, packing and journal box, including dustguard. Where the bearings show the lining nearly or entirely worn out, or brasses cracked or in any other way defective, or the packing becoming soggy, charred or short fibered, box cracked, worn out at back end, dustguard non-effective, etc., they should be renewed.

Such an inspection would of necessity call for a record, and should therefore be handled the same as triple valves and brake cylinders in the matter of dating, inspection and billing, treating a non-inspected or out-of-date car as a cardable defect when offered in interchange, in order to enforce compliance with the rule.

While we feel satisfied that such an inspection, if honestly carried out, would go far toward eliminating hot bearings, one point must not be overlooked, namely—Would it pay?

INTERPRETATIONS OF M. C. B. RULES

At the recent convention of the Chief Interchange Car Inspectors' and Car Foremen's Association, which was reported in the November *Railway Mechanical Engineer* on page 571, several questions were raised by members discussing the rules, which have been answered by interpretations rendered by the M. C. B. Arbitration Committee in M. C. B. Circular No. 20, recently issued. Considerable discussion was given to Rule 4, paragraph 2, at the convention in regard to the uses of defect cards. The Arbitration Committee has submitted the following:

Rule 4—Question: What is meant by the words "damage that is so slight that no repairs are necessary"?

Answer: Raked or cornered sheathing, roof boards, fascia, or bent or cornered end sills not necessitating the shopping of the car.

Note—This ruling abrogates the first interpretation under Rule 4 in the 1916 code.

Under Rule 9 a question regarding the proper substitution of triple valves was raised. The Arbitration Committee has in Circular 20 rendered the following:

Question: In connection with the interpretation shown on page 13 of the 1915 Code of Rules regarding the substitution of Westinghouse triple valves for New York triple valves, or vice versa, what triple valves manufactured by the Westinghouse and New York Air Brake companies are considered as being of similar type?

Answer: The M. C. B. standard K-1 and K-2 triple valves, manufactured by both the Westinghouse and New York air brake companies, are the only triple valves that can be properly considered of similar type and therefore it will be considered as improper repairs to substitute for each other any type of Westinghouse or New York valves except the types K-1 and K-2.

Under Rule 58 the Chief Interchange Car Inspectors' and Car Foremen's Association adopted the motion that it was the sense of the association that a broken angle cock handle was an owner's defect. An interpretation at the bottom of page 81 of the M. C. B. Interchange Rules states that the handling line is responsible for angle cock handles broken or lost under their usage. In Circular 20 the M. C. B. Arbitration Committee speaks on this subject as follows:

Rule 58—Question: Should not the last interpretation under this rule on page 81 of the 1916 code be eliminated?

Answer: Yes. Under the present rules the items referred to are an owner's responsibility.

The question raised by W. Hansen, Chief Interchange In-

spector at Denver, Colo., regarding overlapping labor charges in changing two pair of wheels for the same truck has been answered by the M. C. B. Arbitration Committee in Circular 20 as follows:

Question: On page 184 of the 1916 Code provision is made for reduction of one hour to provide for overlapping of labor. In the case of two pairs of wheels removed and replaced at the same end of car, is it necessary to reduce the labor one hour on one pair of wheels on account of overlapping?

Answer: Yes. This applies to wheels removed and replaced.

A DINING CAR WATER HEATER

By J. F. DONELLON

A home made heater for furnishing hot water to dining car kitchens is shown in the drawing. It has been applied to two Western Maryland dining cars in an effort to get away from the use of Pintsch gas in heating water for dish washing, etc., Pintsch gas having proved rather expensive for this purpose.

As will be noted in the drawing the casing of the heater is a piece of standard 6-in. pipe and the ends are commercial pipe caps. The caps are drilled and tapped for a 2-in. steam line, and drilled so that a 1/2-in. water line can be run through and a stuffing nut used to make a steam tight joint. The heater coil on the inside is of 1/2-in.

railroad to secure the cream of the business in highly competitive territory, on account of being able to furnish good equipment. J. F. Loree, president of the Delaware & Hudson, is quoted as being of the opinion that a freight car is at the money-making task of moving goods one-tenth of the time and is idle or imposing upon its owner for switching, storage, repairs, etc., the other nine-tenths of the time. If this is so the mechanical department should be placed in a position to expedite repairs to equipment.

There are three essential factors in a strong car department organization; thorough co-operation in the department; efficiency, and economy. Maximum output depends on a strong organization. With the increase in the cost of both labor and material it is necessary for the car department head to increase the efficiency of his organization, by contributing to or adding to the capacity or skill of each individual department foreman and employee. Co-operation promotes that feeling of good will and reciprocity which results in increased efficiency. No individual in any department begins, or carries to a successful conclusion, all the work in his department. Therefore, it will be readily seen why it is so necessary that harmony and co-operation should prevail at all times.

There are two distinct classes of employees in the car

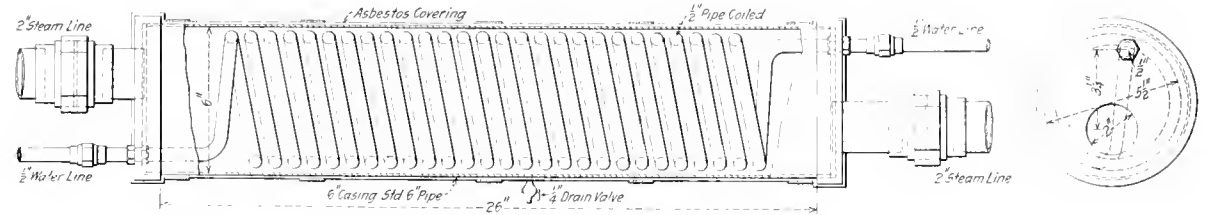

Details of Water Heater Showing Heater Coil

common wrought pipe. The heater is located under the body of the car and is fastened with two 5/8-in. U-bolts, as directly under the kitchen spigots as possible. The 2-in. steam line is tapped direct into the steam heat line and for that reason is only operative about seven months during the year, or through the steam heat season. A test of the heater showed that after it had become thoroughly heated five gallons of water were drawn out and the temperature was 150 deg. F. Two minutes later another five gallons were drawn, the temperature being 120 deg. Four minutes after this another five gallons were drawn out which registered 110 deg. These tests were made with 30-lb. pressure on the steam line.

CAR DEPARTMENT ORGANIZATION AND EFFICIENCY*

BY C. R. DOBSON
Chicago, Boek Island & Pacific

There is no department on a railroad which offers as wide a field for improvement in efficiency as the car department. The shortage of freight car equipment has been very acute in some localities during the past 12 months with no relief in sight. Just think of the cumulative saving in the many directions if a railroad had all good car equipment in first-class serviceable condition. Let us analyze the results if such were the case. There would be a considerable reduction in loss and damage claims, reduction in switching cost, and an unusual reduction in amounts of repair bills rendered by foreign lines. It would lessen the per diem cost of foreign cars, which would not then be required, and enable such a

department, the producer and the non-producer, each class being distinct and actually necessary. The producers are the various classes of employees who actually effect repairs to or rebuild car equipment. The non-producers are many and are composed of foremen, clerks, shop inspectors, tool-room men, supply men, laborers and others; this is equally true in either piece work or day work shops and should not be overlooked. It would be well for every general car foreman to check up his forces and ascertain if there are the correct number of each class of employees in his department to constitute a well-balanced force, and thus determine if a maximum output is being obtained on an economical basis.

Freight cars should, when possible, be handled and repaired as near the base of supplies as possible. Freight car material should never be maintained in stock at any great distance from the repair tracks and shops. If the light repair yard is situated some distance from the shop or heavy repair tracks a sufficient amount of ready material should be carried at the light repair tracks. Supply men should be employed to deliver all lumber from the mill or lumber yard, metal roofs, couplers, brake beams, brake connections; in fact all material possible. The results obtained from this practice will be surprising. The saving in cost is also an attractive feature on account of the difference in the rate of pay, etc. This of course applies more forcefully to shops paid on an hourly basis; however, it will also apply to piece work shops.

Every well organized freight car shop and coach shop should maintain a tool room with a man in charge, whose duty it will be to keep all tools in their proper places, in good order and well lubricated where lubrication is necessary. If the entire time of the man in the tool room is not required in caring for the tools, he can reclaim and sort nuts, washers, nails, cotters and lag screws, picked up in the shop

*Presented at the Chief Interchange Car Inspectors' and Car Foremen's Association convention, held in Indianapolis, Ind., October 3-5, 1916.

and on repair tracks by the labor force and deliver them back into the store stock.

There are also some very interesting as well as profitable results obtained by specializing the men in some lines of car work; for instance, some men are experts in applying roofs, others are more adept in applying sheathing, while still others will be found at their best on rougher work on flat or gondola cars. The appropriation allotted to the car department on most roads usually covers the cost of material used as well as labor, therefore all usable second hand material which accumulates around the larger repair yards and scrap bins should be reclaimed and used on system cars. Every dollar saved can be very profitably applied in repairing bad order cars.

The master car builder or the general foreman of the car department must of necessity be a strong man, of good clear judgment, alert and capable of taking the initiative in all of the many perplexing emergencies which arise in his depart-

ment, and he must be a good judge of human nature to enable him to perfect an organization which will show results for the money expended. There was a time when we were struggling along on very meager appropriations, and, in order to get by, we resorted to the practice of effecting only such repairs as were necessary to move and keep cars in service. The results have been disastrous, and it seems to be very difficult to get the car department out of this rut. This practice of "a lick and a promise" resulted in loaded cars being cut out and sent to every repair track or shop along the line of a long haul. I wish to emphasize at this time the necessity of effecting permanent repairs to equipment requiring both light and heavy repairs and not to discriminate between system or foreign cars; treat them all exactly the same, having in mind at all times that both foreign and system cars should be maintained in good serviceable condition. Eternal vigilance, industry and last, but not least, "honesty" are the price of success.

SOME EXAMPLES OF RECENT DESIGN IN REFRIGERATOR CARS

	Can. Pac. Ref. freight	Can. Pac. Ref. express	Erie Ref.	A. T. & S. F. Ref.	Gt. Nor. Ref.	C. Gt. W. Ref.
Construction	Steel underfr.	Steel underfr.	Steel underfr.	Channel draft sills	All wood	Steel underfr.
Light weight	57,900 lb.	49,200 lb.	53,500 lb.	44,700 lb.	44,000 lb.
Capacity	60,000 cu. ft.	60,000 lb.	60,000 lb.	60,000 lb.	60,000 lb.
Capacity (cubic)	1,990 cu. ft.	2,300 cu. ft.	1,977 cu. ft.	2,000 cu. ft.	1,968 cu. ft.	1,987.7 cu. ft.
Length, over end sills	41 ft. 0 in.	45 ft. 0 in.	39 ft. 1 1/2 in.	41 ft. 3 in.	40 ft. 0 in.	40 ft. 0 in.
Length, inside lining	39 ft. 1 1/8 in.	43 ft. 11 in.	37 ft. 3 3/8 in.	33 ft. 2 3/4 in.	39 ft. 1 3/8 in.	38 ft. 6 1/4 in.
Length, inside to inside of coupler knuckles	43 ft. 1 1/4 in.	48 ft. 4 3/4 in.	41 ft. 10 3/8 in.	44 ft. 4 3/8 in.	42 ft. 9 in.
Length, over couplers	44 ft. 6 in.	48 ft. 11 in.	42 ft. 4 3/8 in.	44 ft. 10 3/8 in.	42 ft. 11 1/2 in.
Length, over side sills	9 ft. 6 in.	9 ft. 0 in.	9 ft. 2 1/4 in.	9 ft. 1 3/4 in.	9 ft. 3 3/4 in.	9 ft. 0 in.
Width, inside lining	8 ft. 7 3/4 in.	8 ft. 7 3/8 in.	8 ft. 3 3/8 in.	8 ft. 2 3/4 in.	8 ft. 2 3/8 in.	8 ft. 1 3/4 in.
Width, over eaves	9 ft. 10 5/8 in.	9 ft. 10 5/8 in.	9 ft. 6 7/8 in.	9 ft. 6 7/8 in.	9 ft. 8 in.	9 ft. 5 1/2 in.
Width, extreme, over all	10 ft. 2 3/8 in.	10 ft. 2 3/8 in.	9 ft. 11 1/4 in.	9 ft. 10 3/4 in.	9 ft. 8 3/8 in.
Height, top of sill to bottom of side plate	7 ft. 9 3/4 in.	7 ft. 9 3/4 in.	7 ft. 7 5/8 in.	7 ft. 3 3/4 in.	7 ft. 7 in.	7 ft. 7 in.
Height, top of rail to eaves	12 ft. 8 1/4 in.	12 ft. 8 1/4 in.	12 ft. 3 3/8 in.	11 ft. 10 3/8 in.	11 ft. 8 in.	12 ft. 1 3/8 in.
Height, top of rail to top of floor	4 ft. 2 1/2 in.	4 ft. 2 1/2 in.	4 ft. 1 3/4 in.	4 ft. 1 3/4 in.	3 ft. 8 in.	4 ft. 1 3/8 in.
Height, top of rail to top of brake mast	14 ft. 0 in.	14 ft. 0 in.	13 ft. 6 in.	14 ft. 7 1/2 in.	14 ft. 1 1/2 in.	14 ft. 1 1/2 in.
Height, top of rail to top of running board	13 ft. 5 1/8 in.	13 ft. 5 1/8 in.	13 ft. 1 1/4 in.	12 ft. 7 1/2 in.	12 ft. 4 3/8 in.	12 ft. 9 in.
Height, top of floor to bottom of carline	7 ft. 9 7/8 in.	7 ft. 9 7/8 in.	7 ft. 6 1/8 in.	7 ft. 3 in.	7 ft. 7 5/8 in.	7 ft. 6 1/8 in.
Side frame members (Z-bar, T-iron, wood, etc.)	Wood	Wood	Wood	Wood	Wood	Wood
Size of side frame members	5 in. x 2 in.	5 in. x 2 in.	5 in. x 1 3/4 in.	5 in. x 2 in.	5 in. x 1 1/2 in.	5 in. x 1 1/2 in.
Type of end	Wood	Wood	Wood, dbl. sheathed	Wood	Wood
Center sills, type (channel, fishbelly or wood)	Fishbelly	Fishbelly	Fishbelly	Continuous channel draft sills	Wood	Channel
Cover plates, length and thickness	* A	* C	35 ft. 7 1/8 in. x 1 1/4 in.	None
Angles, re-inforcing, in center sills, number, position and size	* B	* D	* E	None
Side sills (channel, Z-bar, wood, etc.)	Angle, 6 in. x 4 in. x 3/8 in.	Angle, 6 in. x 4 in. x 3/8 in.	Z-bars, 6 in., 15.6 lb.	Wood, 6 truss rods	Wood, 5 in. x 9 ft.	None
Body bolsters, type	Structural steel	Structural steel	Pressed steel web with cover plates	Built-up	Haskell & Barker Z-bar	Built up
Crossbearers, with or without number	2	2	2	2	2	2
Draft gear, spring or friction	Double board	Double board	Double board	Friction	Spring	Spring
Roof, type	Wood	Wood	Wood	Outside flex. metal	Double board	Double board
Carlines (steel or wood)	18	13	17	Steel and wood	Wood	Wood
Number of carlines	19	15	15
Number of purlines
Type of side door	Miner	Miner	Double door	La Flare patent	Ordinary	Standard ref.
Height and width of side door opening	6 ft. 9 5/8 in. x 5 ft. 0 in.	6 ft. 9 5/8 in. x 5 ft. 0 in.	6 ft. 0 in. x 4 ft. 0 in.	5 ft. 10 1/2 in. x 5 ft. 0 in.	6 ft. 0 in. x 4 ft. 0 in.	6 ft. 0 in. x 4 ft. 0 in.
Height and width of end door opening
Distance, center to center of body bolsters	31 ft. 2 in.	34 ft. 0 in.	28 ft. 8 5/8 in.	30 ft. 11 in.	30 ft. 0 in.	30 ft. 0 in.
Total wheel base	36 ft. 6 in.	40 ft. 8 in.	34 ft. 3 3/8 in.	36 ft. 3 in.	35 ft. 2 in.	35 ft. 6 in.
Truck wheel base	5 ft. 4 in.	6 ft. 8 in.	5 ft. 4 in.	5 ft. 4 in.	5 ft. 2 in.	5 ft. 6 in.
Type of truck	4-wheel	Haskell & Barker
Truck frame, arch bar or cast steel	Arch bar	Steel frame	Steel frame	Steel frame	Arch bar	Arch bar
Truck bolster, type and material
Weight of each truck	7,200 lb.	6,800 lb.	6,800 lb.	5,000 lb.
Wheels, material and size	Cast iron 33 in.	Steel tire 33 in.	Cast iron 33 in.	Cast iron 33 in.	Cast iron 33 in.	Cast iron 33 in.
Material of journal boxes	Malleable	Malleable	Malleable	Malleable	Malleable	Malleable
Refrigeration system	Brine tank	Block ice	Bohn	Bohn syphon	Bohn syphon	Collapsible ice tanks
Ice capacity	6,800 lb.	13,000 lb.	9,244 lb.	278.2 cu. ft.	9,000 lb.	13,600 lb.
Thickness of walls	6 1/2 in.	6 1/2 in.	6 1/2 in.	6 1/2 in.	6 1/2 in.	6 1/2 in.
Insulation, kind of material	Hairfelt	Hairfelt	Linofelt	Flaximum	Linofelt	Hairfelt
Bulkheads, fixed or collapsible	Hinged	Fixed	Collapsible	Removable	Collapsible	Collapsible
Distance between bulkheads	34 ft. 10 in.	36 ft. 10 1/2 in.	31 ft. 9 1/2 in.	33 ft. 2 1/4 in.	32 ft. 9 in.	32 ft. 4 3/4 in.
Ventilators, ordinary hatch or ventilating plug	Ventilators	Ventilators	Ventilating plug	Ventilating plug	Ventilating plug	Ventilating plug
Kind of wood in lining	Basswood	Basswood	Passwood	Fir	Yellow pine	Yellow pine

*A—1 Top, 40 ft. 10 in. x 1 1/4 in.; 2 Bottom, 7 ft. 4 in. x 5 1/2 in.
 *B—2 Top, 3 1/2 in. x 3 1/2 in. x 3 1/2 in.; 4 Bottom, 3 1/2 in. x 3 1/2 in. x 3 1/2 in.
 *C—1 Top, 36 ft. 3 in. x 1 1/4 in.; 2 Bottom, 8 ft. 0 in. x 5 1/2 in.
 *D—4, 3 1/2 in. x 3 1/2 in. x 3 1/2 in.; 4, 3 1/2 in. x 3 1/2 in. x 3 1/2 in.
 *E—2 Outside at bottom, 4 in. x 3 in. x 1/2 in., 31 ft. 8 1/4 in. long.; 2 Inside at bottom, 4 in. x 3 in. x 1/2 in., 29 ft. 11 1/4 in. long.

EXAMPLE OF RECENT BOX CAR DESIGN

	M. K. & T.	Erie	A. T. & S. F.	Gt. Nor.	A. C. L.	III. Cen.	C. M. & St. P.	S. A. L.	C. R. I. & P.	C. St. W.
Light weight	37,700 lb.	39,000 lb.	43,000 lb.	All wood	Steel underfr. frame, ends	Steel frame	Steel underfr.	Steel frame and underfr.	Steel frame	Steel frame and underfr.
Capacity	26,000 lb.	80,000 lb.	80,000 lb.	80,000 lb.	60,000 lb.	10,400 lb.	39,600 lb.	80,000 lb.	40,800 lb.	40,800 lb.
Capacity (cubic)	2,448 cu. ft.	2,448 cu. ft.	2,448 cu. ft.	2,675 cu. ft.	2,448 cu. ft.	2,868 cu. ft.	3,225 cu. ft.	2,264 cu. ft.	2,720 cu. ft.	2,614 cu. ft.
Length, over end sills	36 ft. 0 in.	37 ft. 5 1/2 in.	36 ft. 0 in.	40 ft. 7 3/4 in.	37 ft. 9 in.	41 ft. 5 in.	42 ft. 5 1/2 in.	38 ft. 2 1/4 in.	40 ft. 3 1/2 in.	37 ft. 3 1/2 in.
Length, inside bumpers	36 ft. 0 in.	36 ft. 0 in.	36 ft. 0 in.	40 ft. 0 in.	36 ft. 0 in.	40 ft. 6 in.	41 ft. 5 1/2 in.	35 ft. 11 in.	40 ft. 0 in.	36 ft. 0 in.
Length, inside to inside of coupler knuckles	39 ft. 9 1/4 in.	40 ft. 1 1/2 in.	40 ft. 1 1/2 in.	43 ft. 4 1/2 in.	40 ft. 5 1/2 in.	44 ft. 5 1/2 in.	46 ft. 1 1/2 in.	40 ft. 2 1/4 in.	43 ft. 7 in.	40 ft. 6 1/2 in.
Length, over couplers	9 ft. 3 1/2 in.	9 ft. 7 1/8 in.	9 ft. 7 1/8 in.	9 ft. 8 1/8 in.	9 ft. 11 1/2 in.	8 ft. 9 1/2 in.	9 ft. 6 1/2 in.	8 ft. 7 3/4 in.	8 ft. 9 in.	8 ft. 9 in.
Length, inside bumpers	8 ft. 6 in.	8 ft. 6 1/2 in.	8 ft. 6 in.	8 ft. 1 3/8 in.	8 ft. 6 in.	8 ft. 6 1/2 in.	8 ft. 10 1/8 in.	8 ft. 6 in.	8 ft. 6 in.	8 ft. 6 in.
Width, over ends	9 ft. 4 3/4 in.	9 ft. 6 1/4 in.	9 ft. 6 1/4 in.	9 ft. 7 1/4 in.	9 ft. 6 in.	8 ft. 11 1/2 in.	9 ft. 11 in.	9 ft. 5 in.	9 ft. 5 in.	9 ft. 4 1/4 in.
Width, extreme, over all	9 ft. 6 in.	9 ft. 11 3/4 in.	9 ft. 11 3/4 in.	9 ft. 10 1/4 in.	9 ft. 4 3/4 in.	10 ft. 0 in.	10 ft. 7 3/8 in.	10 ft. 7 3/8 in.	10 ft. 7 3/8 in.	10 ft. 7 3/8 in.
Height, top of sill to bottom of side plate	7 ft. 8 1/2 in.	7 ft. 10 1/2 in.	7 ft. 11 1/2 in.	7 ft. 8 1/2 in.	8 ft. 11 in.	8 ft. 1 1/2 in.	8 ft. 6 1/2 in.	7 ft. 8 in.	7 ft. 10 1/2 in.	8 ft. 2 1/4 in.
Height, top of rail covers	12 ft. 3 1/2 in.	12 ft. 6 1/4 in.	12 ft. 5 7/8 in.	11 ft. 11 in.	11 ft. 9 1/2 in.	12 ft. 3 1/2 in.	12 ft. 8 1/2 in.	11 ft. 11 1/2 in.	12 ft. 9 1/2 in.	11 ft. 11 1/2 in.
Height, top of rail to top of brake mast	4 ft. 0 in.	4 ft. 1 in.	4 ft. 7/8 in.	3 ft. 8 1/4 in.	4 ft. 0 in.	3 ft. 4 1/2 in.	3 ft. 7 1/4 in.	4 ft. 0 in.	3 ft. 9 1/2 in.	4 ft. 3/4 in.
Height, top of rail to top of running board	13 ft. 9 1/2 in.	13 ft. 11 1/2 in.	13 ft. 11 1/2 in.	13 ft. 11 1/2 in.	14 ft. 2 1/2 in.	14 ft. 4 1/2 in.	14 ft. 9 1/4 in.	13 ft. 7 3/8 in.	13 ft. 7 3/8 in.	15 ft. 4 in.
Height, top of rail to top of running board	13 ft. 3 in.	13 ft. 3 1/4 in.	13 ft. 3 1/4 in.	12 ft. 7 1/2 in.	13 ft. 2 1/4 in.	13 ft. 2 3/8 in.	13 ft. 7 in.	12 ft. 10 1/8 in.	12 ft. 10 1/8 in.	13 ft. 6 1/2 in.
Height, top of floor to bottom of carline	8 ft. 5 in.	8 ft. 5 in.	8 ft. 0 in.	7 ft. 9 3/4 in.	7 ft. 8 1/2 in.	8 ft. 3 3/4 in.	8 ft. 11 1/2 in.	7 ft. 6 in.	8 ft. 0 in.	8 ft. 6 in.
Side frame members	Wood	Z-bar posts and braces in side and wood sheathed	Wood	Wood	Wood	Z-bar	Wood	Z-bars and ang.	Z-bars and ch.	Z-bar
Size of side frame members	2 1/2 ft. x 5 in.	Steel plates and sills	Steel plates and sills	Wood	Steel frame, wood	Z-bar	Reinforced	Z-bars x 1 1/4 in.	Wood, with Z bar	3 in. x 8.5 lb
Type of end	Wood	Steel plates and sills	Steel plates and sills	Wood	Steel frame, wood	Z-bar	Reinforced	Z-bars	Wood, with Z bar	Z-bar
Center sills, type	Fishbelly	15 in. ch. 33 lb.	Wood, channel draft sills	Wood	Fishbelly	Fishbelly	Fishbelly	Murphy	Channel	Channel
Cover plates, length and thickness	31 ft. 5 in. x 1 1/4 in.	Bottom 4 ft. 10 in. x 1 1/4 in.	33 ft. 0 in. x 1 1/4 in.	None	Fishbelly, pressed channel 1/2 in. x 20 in.	39 ft. 8 1/4 in. x 1 1/4 in.	15 in., 33 lb. ch
Angles, reinforcing, in center sills, number and position	2 between cross-ties and bolsters	4—Bottom	1 Top, 1 Bottom	2—Bottom	2 Bottom
Angles, reinforcing, in center sills, size	3 in. x 3 in. x 3/8 in.	5 in. x 3 1/2 in. x 3/16 in.	3 1/2 in. x 3 in. Angles
Side sills	Channel	8 in. ch. 11.25	Wood	Wood	Channel	Channel	pressed channel	Z-bar
Body bolsters, type	Built-up	Pressed st. web with cover plates	Pressed st. with cover plates	Haskell & Barker Z-bar	Pressed steel	Built up	Built up	Built-up, pressed steel	Built up
Crossmembers, with or without number
Draft gear, spring or friction
Roof, type
Carlines, type
Number of carlines	8	8	7	13	17	13	13	7	9	15
Number of purlines
Type of side door	Camel No. 27	Frame	Bottom roller	Ordinary	Wood, sliding	M. C. B	Security	National	Camel and National
Height and width of side door opening	7 ft. 4 1/2 in. x 6 ft. 0 in.	7 ft. 8 1/2 in. x 6 ft. 0 in.	7 ft. 7 1/2 in. x 6 ft. 0 in.	7 ft. 6 in. x 5 ft. 5 1/2 in.	6 ft. 0 in.	6 ft. 0 in.	8 ft. 4 1/2 in. x 6 ft. 3 1/4 in.	7 ft. 1 1/2 in. x 6 ft. 0 in.	7 ft. 7 1/2 in. x 6 ft. 0 in.	8 ft. 1 1/2 in. x 6 ft. 0 in.
Height and width of end door opening	22 in. x 24 in.	None	7 1/4 in. x 2 ft. 0 in.	2 ft. 0 in. x 2 ft. 6 in.	None	12 1/4 in. x 2 ft. 2 in.	Ventilator	None	None
Distance, center to center of body	27 ft. 1/2 in.	36 ft. 10 in.	36 ft. 8 1/2 in.	40 ft. 8 1/2 in.	27 ft. 0 in.	30 ft. 9 1/2 in.	32 ft. 3/4 in.	36 ft. 9 1/2 in.	31 ft. 0 in.	36 ft. 11 in.
Total wheel base	32 ft. 4 1/2 in.	32 ft. 2 in.	32 ft. 9 1/2 in.	35 ft. 8 1/2 in.	32 ft. 8 in.	36 ft. 3 1/2 in.	37 ft. 6 1/2 in.	35 ft. 3 1/2 in.	36 ft. 6 in.	32 ft. 5 in.
Truck wheel base	5 ft. 4 in.	5 ft. 4 in.	5 ft. 4 in.	5 ft. 2 in.	5 ft. 4 in.	5 ft. 6 in.	5 ft. 6 in.	5 ft. 6 in.	5 ft. 6 in.	5 ft. 6 in.
Type of truck	Simplex	4-wheel	Andrews cast steel	Arch bar	Rigid	Rigid	Roller bearing	4 wheel	Bentendorf
Truck frame, type and material	Cast steel	Cast steel	Andrews cast steel	Arch bar	Cast steel	Cast steel	Cast steel	Cast steel	Cast steel	Cast steel
Truck bolster, type and material	Cast steel	Simplex steel	Andrews cast steel	Haskell & Barker	Pressed steel	Cast steel	Cast steel	Cast steel	Box and I-sections	Cast steel
Weight of each truck	7,300 lb.	7,000 lb.	7,000 lb.	6,580 lb.	7,000 lb.	5,600 lb.	5,600 lb.	5,600 lb.
Wheels, material	Cast steel	Cast iron	Cast iron	Cast iron	Cast iron	Cast iron	Cast iron	Cast iron	Cast iron
Wheels, size	33 in.	33 in.	33 in.	33 in.	33 in.	67 1/2 lb., 33 in.	33 in.	33 in.	33 in.	33 in.
Material of journal boxes	Malleable	Malleable	Malleable	Malleable	67 1/2 lb., 33 in.	33 in.	33 in.	33 in.	Malleable

* Posts, 3 in. Z-bar, 6.7 lb.; braces, 3 in. x 7, 6.7 lb. and 3 in. x 7, 8.4 lb.
 † Dors, 3 in. x 5 1/2 in.; braces, 1 1/2 in. x 3 in.; T-bars, 3 in. x 3 in. x 5 1/2 in.
 ‡ 1 1/2 in. x 9 lb. channels; 4 in. x 8.2 lb. Z; 3 in. x 6.7 lb. Z; 3 in. x 8.4 lb. Z.
 § Side plate, 3 1/2 in. x 7 in.; posts, 2 1/2 in. x 4 5/8 in.; braces, 2 1/2 in. x 5 in.
 ** Top, 2 ft. 8 in. x 2 ft. 0 in.; bottom, 1 ft. 6 1/2 in. x 2 ft. 0 in.

EXAMPLE OF RECENT BOX CAR DESIGN

Railroad	D. L. & W.	El Paso & Southwestern	L. & N.	B. & O.	B. & M.	N. X. N. H. & H.	U. Pac.	B. & L. E.	B. & L. E.	S. P.	C. & O.
Type of car	St. underfr.	St. underfr.	St. underfr.	St. underfr.	St. underfr.	St. underfr.	St. underfr.	St. underfr.	All steel	Steel frame	Steel fr. and underframe
Light weight	40,500 lb.	43,000 lb.	40,400 lb.	39,400 lb.	37,400 lb.	37,000 lb.	43,200 lb.	46,700 lb.	45,900 lb.	41,600 lb.	39,000 lb.
Capacity (cubic)	200,000 cu. ft.	100,000 lb.	80,000 lb.	80,000 lb.	60,000 lb.	60,000 lb.	100,000 lb.	100,000 lb.	100,000 lb.	100,000 lb.	80,000 lb.
Length, over end sills	2,931 cu. ft.	2,931 cu. ft.	2,448 cu. ft.	2,811.4 cu. ft.	2,475 cu. ft.	2,444 cu. ft.	3,509 cu. ft.	2,229 cu. ft.	2,837 cu. ft.	3,358 cu. ft.	3,745 cu. ft.
Length, inside lining	36 ft. 4 3/8 in.	40 ft. 0 in.	36 ft. 0 in.	42 ft. 6 in.	37 ft. 9 3/4 in.	37 ft. 9 3/4 in.	40 ft. 1 7/8 in.	42 ft. 1 3/4 in.	41 ft. 6 in.	40 ft. 8 3/4 in.	37 1/2 ft. 0 in.
Knuckles	39 ft. 11 in.	43 ft. 11 in.	39 ft. 11 1/2 in.	45 ft. 2 3/4 in.	40 ft. 9 in.	39 ft. 8 3/4 in.	44 ft. 1 1/2 in.	44 ft. 1 3/4 in.	43 ft. 6 in.	44 ft. 1 1/2 in.	40 ft. 5 1/2 in.
Length, over couplers	40 ft. 5 in.	44 ft. 5 in.	39 ft. 4 1/2 in.	45 ft. 8 3/4 in.	40 ft. 9 in.	40 ft. 9 in.	44 ft. 6 1/4 in.	44 ft. 0 in.	44 ft. 6 in.	44 ft. 6 1/4 in.	40 ft. 1 1/2 in.
Width, inside lining	9 ft. 5 1/2 in.	9 ft. 5 1/2 in.	9 ft. 1 1/2 in.	8 ft. 7 in.	8 ft. 6 in.	8 ft. 11 3/4 in.	9 ft. 2 in.	9 ft. 2 in.	8 ft. 6 1/2 in.	9 ft. 5 in.	9 ft. 1 3/4 in.
Width, over axles	8 ft. 6 in.	8 ft. 6 in.	8 ft. 6 in.	8 ft. 7 in.	8 ft. 6 in.	8 ft. 11 3/4 in.	9 ft. 2 in.	8 ft. 6 1/2 in.	8 ft. 6 1/2 in.	9 ft. 7 in.	8 ft. 6 in.
Width, extreme, over all	9 ft. 4 1/2 in.	9 ft. 4 1/2 in.	9 ft. 5 1/4 in.	9 ft. 6 1/2 in.	9 ft. 5 in.	9 ft. 5 in.	9 ft. 6 1/2 in.	9 ft. 6 1/2 in.	9 ft. 7 1/8 in.	9 ft. 7 in.	8 ft. 6 in.
Height, top of sill to bottom of side plate	7 ft. 9 1/2 in.	7 ft. 10 3/4 in.	7 ft. 9 1/2 in.	8 ft. 1 1/8 in.	8 ft. 1 1/8 in.	7 ft. 11 3/8 in.	9 ft. 1 1/2 in.	10 ft. 6 in.	10 ft. 1 3/8 in.	10 ft. 5 1/4 in.	9 ft. 7 in.
Height, top of rail to eaves	12 ft. 2 1/4 in.	12 ft. 1 1/8 in.	12 ft. 3 1/8 in.	11 ft. 11 7/8 in.	12 ft. 8 in.	13 ft. 7 7/8 in.	13 ft. 7 7/8 in.	11 ft. 4 1/8 in.	11 ft. 0 3/4 in.	13 ft. 8 in.	12 ft. 3 3/8 in.
Height, top of rail to top of floor	4 ft. 1 1/2 in.	3 ft. 9 1/8 in.	4 ft. 3 1/2 in.	3 ft. 7 3/8 in.	4 ft. 1 1/2 in.	4 ft. 1 1/2 in.	3 ft. 9 7/8 in.	4 ft. 1 1/2 in.	3 ft. 6 1/4 in.	3 ft. 9 1/8 in.	3 ft. 6 1/4 in.
Height, top of rail to top of brake mast	13 ft. 6 1/4 in.	12 ft. 11 1/8 in.	13 ft. 1 7/8 in.	12 ft. 11 1/4 in.	13 ft. 1 1/2 in.	13 ft. 3 1/4 in.	14 ft. 9 in.	13 ft. 10 1/2 in.	13 ft. 1 1/2 in.	14 ft. 8 1/8 in.	13 ft. 8 in.
Height, top of rail to top of running board	12 ft. 11 1/2 in.	12 ft. 11 1/8 in.	13 ft. 1 7/8 in.	12 ft. 11 1/4 in.	13 ft. 1 1/2 in.	13 ft. 3 1/4 in.	14 ft. 9 in.	13 ft. 10 1/2 in.	13 ft. 1 1/2 in.	14 ft. 8 1/8 in.	13 ft. 8 in.
Height, top of floor to bottom of car line	8 ft. 0 in.	6 ft. 10 3/4 in.	8 ft. 0 in.	8 ft. 1 1/2 in.	8 ft. 1 1/2 in.	8 ft. 1 1/2 in.	9 ft. 4 1/2 in.	8 ft. 0 in.	8 ft. 0 in.	9 ft. 8 in.	7 ft. 11 in.
Side frame members	Wood	Wood	Wood	Wood	Wood	Wood	Wood	Wood, reinforced by angles	Wood, reinforced by channels	Z-bars and angles	Z-bars and Z-bars
Size of side frame members	5 in. x 2 1/2 in.	2 1/2 in. x 5 in.	Posts 4 1/2 in. x 3 in. x 3 1/2 in. 3 in. x 3 in. 3 in. x 3 in.	3 in. x 3 in. x 3 1/2 in.	1 3/4 in. x 4 1/4 in. 1 3/4 in. x 6 in. 1 3/4 in. x 6 in.	15 in. x 33 lb channel	34 in. x 3 1/2 in. x 3 1/2 in.	13 ft. 2 3/8 in.	2 1/4 in. x 3 in. x 2 1/4 in.	3 in. x 6 7/8 in. x 3 in. x 6 7/8 in.	15 in. x 33 lb channel
Type of end	Wood	Wood	Murphy	Wood	Wood	Wood	Corrugated st.	Fishbelly	Channel	Fishbelly	Wood beamed with Z-bars and Z-bars
Center sills, type	12-in. ch	Fishbelly	Fishbelly	Fishbelly	Channel	15-in. 33-lb channel	34 in. order beam	Fishbelly	Channel	Fishbelly	Wood beamed with Z-bars and Z-bars
Cover plates, length and thickness	34 ft. 6 in. x 1/2 in.	37 ft. 8 in. x 1/2 in.	31 ft. 2 1/2 in. x 1/2 in.	37 ft. 2 3/4 in. x 1/2 in.	33 ft. 4 1/4 in. x 1/2 in.	33 ft. 6 in. x 1/2 in.	None	34 ft. 10 1/2 in. x 1 1/2 in.	None	39 ft. 3 1/2 in. x 1 1/2 in.	3 in. x 6 7/8 in. x 3 in. x 6 7/8 in.
Angles, reinforcing, in center sills, number and position	None	2—Top, 4—Bottom	Six	4—Bottom	None	None	None	2—Bottom	None	4—Bottom	Bottom cross plates
Angles, reinforcing, in center sills, size	None	3 1/2 in. x 3 in. x 3 1/2 in. x 3 in.	3 1/2 in. x 3 in. x 3 1/2 in. x 3 in.	3 1/2 in. x 3 in. x 3 1/2 in. x 3 in.	None	None	None	3 1/2 in. x 3 in. x 3 1/2 in. x 3 in.	None	3 1/2 in. x 3 in. x 3 1/2 in. x 3 in.	Bottom cross plates
Side sill	Channels and angles	9-in. 13.25-lb channel	10-in. 15-lb channel	7-bar	Pressed steel	5-in. 11.6-lb. Built-up	Z-bar, wood sub-sill	2—3 in. x 3 in. diaphragms	Pressed steel	9-in. 13.25 lb channel	Pressed steel
Body bolsters, type	Built-up	Built-up	Built-up	Pressed steel	Pressed steel	Built-up	Cast st.	2—3 in. x 3 in. diaphragms	2—3 in. x 3 in. diaphragms	Pressed steel diaphragms	Pressed steel
Crossbearers, with or without number	8	2	2	2	2	7	5	2	6	2	With Spring Murphy
Draft gear, spring or friction	Chicago-Cleaveland all steel	Wood	Spring Murphy, outside metal	Friction	Friction	Friction	Spring Murphy, all steel	Friction Murphy, outside metal	Friction Summer's st	Spring Murphy, outside metal	With Spring Murphy
Roof, type	Wood	Wood	Wood	Steel	Steel	Steel	Steel	Steel	Steel	Steel	Wood, reinforced with angles
Carlines, type	Wood	Wood	Wood	Steel	Steel	Steel	Steel	Steel	Steel	Steel	Wood, reinforced with angles
Number of carlines	11	0	0	9	7	7	11	5	0	0	0
Number of purlines	2	0	0	4	4	4	4	9	0	0	0
Type of side door	Wood	Batten	Camel	Miner, double	Security, No. 5	Wood roller slide	Wood, outside hung	Jones, Peers	Summer's st	Camel	Hung from top
Height and width of side door opening	7 ft. 6 in. x 6 ft. 0 in.	7 ft. 6 1/2 in. x 6 ft. 0 in.	7 ft. 5 1/2 in. x 6 ft. 0 in.	7 ft. 8 in. x 10 ft. 0 in.	7 ft. 8 1/4 in. x 6 ft. 0 in.	7 ft. 8 1/4 in. x 6 ft. 0 in.	8 ft. 8 1/4 in. x 12 in. x 18 1/2 in.	7 ft. 5 1/2 in. x 6 ft. 0 in.	7 ft. 3 in. x 6 ft. 0 in.	8 ft. 7 in. x 6 ft. 0 in.	7 ft. 6 1/2 in. x 5 ft. 6 in.
Distance, center to center of body bolsters	27 ft. 0 in.	30 ft. 8 in.	31 ft. 9 1/2 in.	32 ft. 2 1/2 in.	32 ft. 11 3/4 in.	27 ft. 9 1/2 in.	30 ft. 8 in.	30 ft. 10 1/2 in.	30 ft. 0 in.	30 ft. 8 in.	26 ft. 10 in.
Truck wheel base	32 ft. 6 in.	36 ft. 2 in.	37 ft. 6 3/4 in.	37 ft. 6 3/4 in.	35 ft. 4 in.	35 ft. 4 in.	36 ft. 8 in.	36 ft. 5 in.	35 ft. 6 in.	35 ft. 2 in.	32 ft. 4 in.
Type of truck	4 wheel	Arch bar	Scullin, cast	Barber, lateral	Arch bar	Arch bar	Vulcan & Bet tendorf	Barber	Summer's	Returnoff	3 ft. 6 in.
Truck frame	7 type steel	Arch bar	Cast steel	Cast steel	Arch bar	Arch bar	Cast steel	Arch bar	Summer's	Arch bar	Arch bar
Truck bolster, type and material	Simplex	Simplex	Scullin cast steel	Cast steel	Arch bar	Arch bar	Cast steel	Simplex, steel	Summer's st	Simplex	Arch bar
Weight of each truck	7,300 lb.	7,400 lb.	6,438 lb.	6,825 lb.	6,325 lb.	5,980 lb.	7,447 lb.	8,050 lb.	8,050 lb.	7,593 lb.	Cast iron
Wheels, material	Cast iron	Cast iron	Cast steel	Cast iron	Cast iron	Cast iron	Cast iron	Cast iron	Cast iron	Cast iron	Cast iron
Material of journal boxes	Steel	Malleable	Malleable	Malleable	Malleable	Malleable	Malleable	Pressed steel	Pressed steel	Malleable	Pressed st

Note—See foot note references on the opposite page.

EXAMPLES OF RECENT DESIGN IN AUTOMOBILE CARS

	Gate, Auto.	I. & S. F. Auto.	Gov. Narr. Auto.	Ill. C. Auto.	C. M. & St. P. Auto.	C. R. I. & P. Auto.	L. & N. Auto.	N. Y. N. H. & H. Auto.	U. Pac. Auto.	S. Pac. Auto.
Railroad car	St. underfr.	St. underfr.	St. underfr.	St. underfr.	St. underfr.	St. underfr.	St. underfr.	St. underfr.	St. underfr.	St. underfr.
Weight	40,800 lb.	40,800 lb.	40,800 lb.	40,800 lb.	40,800 lb.	40,800 lb.	40,800 lb.	40,800 lb.	40,800 lb.	40,800 lb.
Length	33.200 ft.	33.200 ft.	33.200 ft.	33.200 ft.	33.200 ft.	33.200 ft.	33.200 ft.	33.200 ft.	33.200 ft.	33.200 ft.
Width	80.000 ft.	80.000 ft.	80.000 ft.	80.000 ft.	80.000 ft.	80.000 ft.	80.000 ft.	80.000 ft.	80.000 ft.	80.000 ft.
Capacity (seats)	3,584 cu. ft.	3,584 cu. ft.	3,584 cu. ft.	3,584 cu. ft.	3,584 cu. ft.	3,584 cu. ft.	3,584 cu. ft.	3,584 cu. ft.	3,584 cu. ft.	3,584 cu. ft.
Length, over end sills	30 ft. 6 in.	30 ft. 6 in.	30 ft. 6 in.	30 ft. 6 in.	30 ft. 6 in.	30 ft. 6 in.	30 ft. 6 in.	30 ft. 6 in.	30 ft. 6 in.	30 ft. 6 in.
Length, inside lining	13 ft. 8 1/2 in.	13 ft. 8 1/2 in.	13 ft. 8 1/2 in.	13 ft. 8 1/2 in.	13 ft. 8 1/2 in.	13 ft. 8 1/2 in.	13 ft. 8 1/2 in.	13 ft. 8 1/2 in.	13 ft. 8 1/2 in.	13 ft. 8 1/2 in.
Length, over complex	11 ft. 8 1/2 in.	11 ft. 8 1/2 in.	11 ft. 8 1/2 in.	11 ft. 8 1/2 in.	11 ft. 8 1/2 in.	11 ft. 8 1/2 in.	11 ft. 8 1/2 in.	11 ft. 8 1/2 in.	11 ft. 8 1/2 in.	11 ft. 8 1/2 in.
Width, over side sills	8 ft. 7 3/8 in.	8 ft. 7 3/8 in.	8 ft. 7 3/8 in.	8 ft. 7 3/8 in.	8 ft. 7 3/8 in.	8 ft. 7 3/8 in.	8 ft. 7 3/8 in.	8 ft. 7 3/8 in.	8 ft. 7 3/8 in.	8 ft. 7 3/8 in.
Width, inside lining	8 ft. 0 in.	8 ft. 0 in.	8 ft. 0 in.	8 ft. 0 in.	8 ft. 0 in.	8 ft. 0 in.	8 ft. 0 in.	8 ft. 0 in.	8 ft. 0 in.	8 ft. 0 in.
Width, over eaves	9 ft. 17 1/2 in.	9 ft. 17 1/2 in.	9 ft. 17 1/2 in.	9 ft. 17 1/2 in.	9 ft. 17 1/2 in.	9 ft. 17 1/2 in.	9 ft. 17 1/2 in.	9 ft. 17 1/2 in.	9 ft. 17 1/2 in.	9 ft. 17 1/2 in.
Width, extreme over all	10 ft. 11 1/4 in.	10 ft. 11 1/4 in.	10 ft. 11 1/4 in.	10 ft. 11 1/4 in.	10 ft. 11 1/4 in.	10 ft. 11 1/4 in.	10 ft. 11 1/4 in.	10 ft. 11 1/4 in.	10 ft. 11 1/4 in.	10 ft. 11 1/4 in.
Height, top of sill to bottom of sills	9 ft. 1 1/4 in.	9 ft. 1 1/4 in.	9 ft. 1 1/4 in.	9 ft. 1 1/4 in.	9 ft. 1 1/4 in.	9 ft. 1 1/4 in.	9 ft. 1 1/4 in.	9 ft. 1 1/4 in.	9 ft. 1 1/4 in.	9 ft. 1 1/4 in.
Height, top of rail to eaves	13 ft. 17 1/2 in.	13 ft. 17 1/2 in.	13 ft. 17 1/2 in.	13 ft. 17 1/2 in.	13 ft. 17 1/2 in.	13 ft. 17 1/2 in.	13 ft. 17 1/2 in.	13 ft. 17 1/2 in.	13 ft. 17 1/2 in.	13 ft. 17 1/2 in.
Height, top of tail to top of brake mast	3 ft. 7 3/8 in.	3 ft. 7 3/8 in.	3 ft. 7 3/8 in.	3 ft. 7 3/8 in.	3 ft. 7 3/8 in.	3 ft. 7 3/8 in.	3 ft. 7 3/8 in.	3 ft. 7 3/8 in.	3 ft. 7 3/8 in.	3 ft. 7 3/8 in.
Height, top of rail to top of running gear	14 ft. 4 1/8 in.	14 ft. 4 1/8 in.	14 ft. 4 1/8 in.	14 ft. 4 1/8 in.	14 ft. 4 1/8 in.	14 ft. 4 1/8 in.	14 ft. 4 1/8 in.	14 ft. 4 1/8 in.	14 ft. 4 1/8 in.	14 ft. 4 1/8 in.
Height, top of floor to bottom of carline	9 ft. 3 1/2 in.	9 ft. 3 1/2 in.	9 ft. 3 1/2 in.	9 ft. 3 1/2 in.	9 ft. 3 1/2 in.	9 ft. 3 1/2 in.	9 ft. 3 1/2 in.	9 ft. 3 1/2 in.	9 ft. 3 1/2 in.	9 ft. 3 1/2 in.
Side frame members	Z-bar	Z-bar	Z-bar	Z-bar	Z-bar	Z-bar	Z-bar	Z-bar	Z-bar	Z-bar
Size of side frame members	4 1/2 in. x 3 in.	4 1/2 in. x 3 in.	4 1/2 in. x 3 in.	4 1/2 in. x 3 in.	4 1/2 in. x 3 in.	4 1/2 in. x 3 in.	4 1/2 in. x 3 in.	4 1/2 in. x 3 in.	4 1/2 in. x 3 in.	4 1/2 in. x 3 in.
Type of end	Steel fr. single sheathed	Steel doors one end, other wood	Steel doors one end, other wood	Pressed steel	Reinforced door one end	Wood with U-beam end-plates	Murphy st. end	Wood	Corrugated st.	Z bars and ch.
Center sills, type	None	Wood	Wood	Fishbelly	Fishbelly	Ch. with cover plate	None	15 in. x 3 in.	20-in. girder	Fishbelly
Cover plates, length and thickness	None	50 ft. 9 1/4 in. x 3 1/4 in.	50 ft. 9 1/4 in. x 3 1/4 in.	43 ft. 0 in. x 3 1/4 in.	None	37 ft. 0 in. x 3 1/4 in.	None	33 ft. 4 1/2 in. x 3 1/4 in.	None	51 ft. 1/2 in. x 3 1/4 in.
Angles, reinforcing, in center sills	None	1 3/8 in. x 3 in.	1 3/8 in. x 3 in.	2 Top, 2 Bottom	None	3 in. x 3 in. x 3 in.	None	2 Bottom, 3 1/2 in. x 3 in. x 3 in.	None	4 Bottom, 3 1/2 in. x 3 in. x 3 in.
Side sills	16-in. pressed st. plate	Wood	Wood	Channel	16-in. x 6 in. Z-bar and wood	Ch. with wood fillers	4-in. x 3 in. x 3 in. angle	5 in. x 3 in. x 3 in. Z-bar	5 in. Z-bar, wood sub-sill	Pressed steel diaphragm
Body bolsters, type	Pressed st. web with cover plate	Built-up, pressed fillets	Z-bar	Built-up	Friction	Friction	Bettendorff, cast steel	Friction	Cast steel	Pressed steel diaphragm
Crossbeams, type	With cover plate	With cover plate	With cover plate	With cover plate	With cover plate	With cover plate	With cover plate	With cover plate	With cover plate	With cover plate
Draw gear, spring or friction	Friction	Friction	Friction	Friction	Friction	Friction	Friction	Friction	Friction	Friction
Roof, type	Outside steel	Outside steel	Outside steel	Outside steel	Outside steel	Outside steel	Outside steel	Outside steel	Outside steel	Outside steel
Carlines	Steel	Steel	Steel	Steel	Steel	Steel	Steel	Steel	Steel	Steel
Number of carlines	4	4	4	4	4	4	4	4	4	4
Number of purlines	Sheathed	Large double	Ordinary	M. C. B.	Security	Chimney	Camel	Double, sliding	Double, outside lining	Camel
Type of side door	8 ft. 8 1/2 in. x 10 ft. 0 in.	9 ft. 6 1/2 in. x 10 ft. 2 1/8 in.	9 ft. 7 in. x 10 ft. 5 1/2 in.	9 ft. 4 1/2 in. x 10 ft. 0 in.	9 ft. 4 1/2 in. x 10 ft. 0 in.	9 ft. 5 1/4 in. x 8 ft. 0 in.	7 ft. 5 1/4 in. x 10 ft. 0 in.	12 ft. x 7 ft. 8 1/2 in.	9 ft. 5 1/2 in. x 10 ft. 5 1/8 in.	9 ft. 6 1/2 in. x 10 ft. 5 1/8 in.
Height and width of side door opening	9 ft. 3 in. x 8 ft. 6 in.	9 ft. 7 1/4 in. x 8 ft. 4 in.	9 ft. 5 in. x 8 ft. 0 in.	None	9 ft. 2 in. x 7 ft. 8 1/2 in.	9 ft. 1 in. x 8 ft. 8 in.	None	None	9 ft. 5 1/4 in. x 7 ft. 10 in.	9 ft. 6 in. x 7 ft. 9 1/4 in.
Height and width of end door opening	39 ft. 8 in.	40 ft. 4 1/4 in.	35 ft. 10 in.	46 ft. 9 1/2 in.	36 ft. 6 in.	31 ft. 0 in.	30 ft. 9 1/2 in.	27 ft. 0 1/2 in.	45 ft. 4 in.	40 ft. 6 in.
Distance, center to center of body bolsters	35 ft. 0 in.	45 ft. 8 1/4 in.	35 ft. 10 in.	46 ft. 9 1/2 in.	36 ft. 2 1/2 in.	31 ft. 0 in.	30 ft. 9 1/2 in.	32 ft. 11 1/4 in.	45 ft. 10 in.	46 ft. 0 in.
Total wheel base	5 ft. 4 in.	5 ft. 4 in.	5 ft. 4 in.	5 ft. 4 in.	5 ft. 4 in.	5 ft. 4 in.	5 ft. 4 in.	5 ft. 4 in.	5 ft. 6 in.	5 ft. 6 in.
Truck wheel base	4 wheel	4 wheel	4 wheel	4 wheel	4 wheel	4 wheel	4 wheel	4 wheel	4 wheel	4 wheel
Type of truck	Cast steel	Cast steel	Cast steel	Cast steel	Cast steel	Cast steel	Cast steel	Cast steel	Cast steel	Cast steel
Truck frame, arch bar or cast steel	Simplex st. plate	Cast steel	Cast steel	Cast steel	Cast steel	Cast steel	Cast steel	Cast steel	Cast steel	Cast steel
Truck bolster, type and material	7,300 lb.	7,000 lb.	7,000 lb.	6,580 lb.	6,750 lb.	6,750 lb.	6,750 lb.	6,750 lb.	7,507 lb.	7,387 lb.
Weight of each truck	Cast iron	Cast iron	Cast iron	Cast iron	Cast iron	Cast iron	Cast iron	Cast iron	Cast iron	Cast iron
Wheels, size	675 lb.	33 in.	33 in.	33 in.	33 in.	33 in.	33 in.	33 in.	33 in.	33 in.
Wheels, material	Malleable	Malleable	Malleable	Malleable	Malleable	Malleable	Malleable	Malleable	Malleable	Malleable
Material of journal boxes	If all-steel, special means for holding lading									
If all-steel, special means for holding lading										

* Posts, 3-in. Z-bars, 6.7 lb., and 2 1/2 in. x 7/8 in. x 3/4 in. plate. † Two flanged plates, Z-shaped, connected by 1/4 in. x 4-in. plate at top side and wooden stringers.

EXAMPLES OF RECENT DESIGN IN STOCK CARS

	A. T. & S. F.	Ill. Cent.	C. M. & St. P.	C. R. I. & P.	C. Gt. W.	D. L. & W.	E. P. & S. W.	L. & N.	B. & O.	U. Pac.	S. Pac.
Light weight	47,600 lb.	36,000 lb.	39,010 lb.	37,500 lb.	33,800 lb.	38,800 lb.	38,800 lb.	40,900 lb.	36,400 lb.	35,600 lb.	45,600 lb.
Capacity	80,000 cu. ft.	80,000 cu. ft.	80,000 lb.	80,000 lb.	60,000 lb.	80,000 lb.	80,000 lb.	80,000 lb.	86,000 lb.	80,000 lb.	80,000 lb.
Capacity (tonnage)	2,500 cu. ft.	2,310 cu. ft.	3,250 cu. ft.	2,272 cu. ft.	2,328 cu. ft.	2,872 cu. ft.	2,453 cu. ft.	2,330 cu. ft.	2,608 cu. ft.	2,608 cu. ft.	2,506 cu. ft.
Length, inside timbers	40 ft. 0 in.	40 ft. 10 in.	36 ft. 3 in.	36 ft. 3 in.	36 ft. 0 in.	36 ft. 0 in.	36 ft. 0 in.	38 ft. 7 in.	36 ft. 8 in.	36 ft. 8 in.	36 ft. 7 3/8 in.
Length, inside of coupler knuckles	44 ft. 1 1/8 in.	44 ft. 5 1/2 in.	39 ft. 1 1/2 in.	39 ft. 8 1/4 in.	39 ft. 6 1/4 in.	39 ft. 1 1/2 in.	40 ft. 3 1/4 in.	41 ft. 10 in.	40 ft. 1 in.	40 ft. 1 in.	40 ft. 6 3/8 in.
Length, over couplers	44 ft. 7 7/8 in.	44 ft. 19 in.	39 ft. 7 1/2 in.	40 ft. 2 1/4 in.	39 ft. 5 3/4 in.	39 ft. 5 3/4 in.	40 ft. 4 1/4 in.	42 ft. 4 in.	40 ft. 1 in.	40 ft. 1 in.	40 ft. 1 in.
Width, over side sills	8 ft. 19 in.	9 ft. 2 1/4 in.	8 ft. 8 in.	8 ft. 11 1/2 in.	9 ft. 5 1/4 in.	9 ft. 3 1/2 in.	9 ft. 2 1/2 in.	9 ft. 7 in.	8 ft. 7 1/4 in.	9 ft. 5 1/8 in.	9 ft. 5 1/8 in.
Width, inside timing	9 ft. 6 in.	9 ft. 2 1/4 in.	8 ft. 6 3/4 in.	8 ft. 18 in.	8 ft. 3 in.	8 ft. 4 in.	9 ft. 0 in.	8 ft. 6 1/2 in.	8 ft. 5 1/4 in.	8 ft. 5 1/4 in.	8 ft. 10 1/8 in.
Width, extreme, over all	10 ft. 5 in.	9 ft. 7 1/4 in.	9 ft. 8 1/4 in.	9 ft. 8 3/8 in.	9 ft. 10 1/2 in.	9 ft. 10 1/2 in.	10 ft. 6 in.	10 ft. 9 in.	9 ft. 3 1/4 in.	10 ft. 1 1/8 in.	10 ft. 1 1/8 in.
Height, top of sill to bottom of plate	6 ft. 10 in.	7 ft. 0 in.	7 ft. 5 1/2 in.	7 ft. 5 1/2 in.	7 ft. 2 1/4 in.	7 ft. 7 in.	8 ft. 1 3/8 in.	7 ft. 2 1/4 in.	8 ft. 1 1/2 in.	7 ft. 11 1/2 in.	7 ft. 11 1/2 in.
Height, top of rail to ceiling	11 ft. 7 3/4 in.	11 ft. 9 in.	11 ft. 7 1/2 in.	11 ft. 5 1/8 in.	11 ft. 10 1/8 in.	12 ft. 1 in.	12 ft. 1 1/8 in.	11 ft. 9 1/4 in.	12 ft. 4 1/2 in.	12 ft. 4 1/2 in.	12 ft. 4 1/2 in.
Height, top of rail to top of floor	3 ft. 7 1/2 in.	4 ft. 0 in.	4 ft. 0 in.	4 ft. 1 1/4 in.	4 ft. 1 1/4 in.	3 ft. 6 1/4 in.	4 ft. 3 1/4 in.	4 ft. 3 1/4 in.	4 ft. 3 1/4 in.	3 ft. 9 1/8 in.	3 ft. 9 1/8 in.
Height, top of rail to top of timbers	14 ft. 6 in.	13 ft. 6 in.	13 ft. 6 1/2 in.	13 ft. 11 1/4 in.	13 ft. 5 1/8 in.	14 ft. 3 1/4 in.	13 ft. 1 1/2 in.	13 ft. 8 1/2 in.	13 ft. 6 1/2 in.	13 ft. 6 1/2 in.	13 ft. 9 1/8 in.
Height, top of floor to bottom of carline	12 ft. 6 in.	12 ft. 5 1/4 in.	12 ft. 1 1/4 in.	12 ft. 3 1/8 in.	12 ft. 6 1/8 in.	12 ft. 9 in.	12 ft. 11 1/8 in.	12 ft. 7 1/4 in.	13 ft. 3 1/4 in.	13 ft. 4 1/8 in.	13 ft. 4 1/8 in.
Side frame members	6 ft. 10 in.	7 ft. 2 1/4 in.	11 ft. 5 1/4 in.	7 ft. 4 1/2 in.	7 ft. 4 1/2 in.	7 ft. 8 1/2 in.	7 ft. 11 1/8 in.	7 ft. 4 1/2 in.	7 ft. 10 1/8 in.	8 ft. 4 1/2 in.	8 ft. 4 1/2 in.
Size of sill frame members	3 in.	5 in. x 2 1/2 in.	6 in. x 2 in.	3 in. x 4 in.	5 in. x 4 in.	3 in. x 3 1/4 in.	3 in. x 6 1/2 in.	Posts 3 1/2 in. x 3 in. x 3 in.	3 in. x 5 lb. Z.	3 in. x 5 lb. Z.	3 in. x 5 lb. Z.
Type of end	Z-bar	Z-bar	Wood slatted	Wood with I-beam end posts	Wood	Wood posts and braces	Z-bars	Wood	I-beams and Z-bars	Corrugated steel	Z-bars and angles
Center sills, type (channel, fishbody or wood)	Channel	Wood	Special 18-in. I-beam	Channel	Channel	Wood 4 1/2 in. x 5 in.	Ch. 13 in. x 3 1/2 lb.	Fishbody	Channel	18-in. girder beam	Fishbody
Cover plates, length and thickness	40 ft. 10 3/8 in. x 1 1/4 in.	39 ft. 1 1/2 in. x 3 1/4 in.	34 ft. 3 in. x 3 in.	35 ft. 2 1/4 in. x 3 1/4 in.	None	None
Angles, re-inforcing, in center sills, number, position and size
Side sills (channel, Z-bar, wood, etc.)	Channel	Wood	Channeled 7 in. girder beam
Body bolsters, type	Built up cast and press, steel	Cast steel box section	With Friction Wood	1 section steel built up
Cross-hangers, with or without number
Draft gear, spring or friction
Roof, type	Outside flexible metal	Steel	Shatted	Double board	Spring Wood	Double board	Friction Single board	Spring Double board	Friction Wood	Spring Wood	Spring Wood
Carlines (steel or wood)	Steel	Steel	Wood	Steel	Steel	Steel	Steel	Wood	Wood	Steel	Steel
Number of carlines	17	9	35	11	7	7	6	8	4	7	2
Type of side door	Double for double deck
Height and width of side door opening	6 ft. 9 3/4 in. x 5 ft. 1 in.	6 ft. 0 1/8 in. x 5 ft. 0 in.	3 ft. 5 1/4 in. x 2 ft. 3 in.	6 ft. 9 in. x 5 ft. 0 in.	7 ft. 11 1/8 in. x 6 ft. 0 in.	7 ft. 4 1/2 in. x 5 ft. 0 in.	7 ft. 11 in. x 6 ft. 0 in.	7 ft. 1 in. x 5 ft. 0 in.	7 ft. 5 3/4 in. x 5 ft. 0 in.	7 ft. 10 in. x 5 ft. 0 in.	7 ft. 10 in. x 5 ft. 0 in.
Height and width of end door opening	ft. 1 in.
Distance, center to center of body bolsters	30 ft. 7 3/8 in.	30 ft. 4 in.	25 ft. 5 in.	27 ft. 3 in.	27 ft. 8 1/2 in.	30 ft. 6 in.	30 ft. 6 in.	28 ft. 3 in.	26 ft. 19 in.	26 ft. 8 in.	26 ft. 8 in.
Total wheel base	35 ft. 1 1/8 in.	35 ft. 10 in.	30 ft. 5 in.	32 ft. 9 in.	32 ft. 1 1/2 in.	36 ft. 6 1/8 in.	36 ft. 6 in.	33 ft. 8 in.	32 ft. 2 1/2 in.	32 ft. 2 in.	32 ft. 2 in.
Truck wheel base
Truck frame, arch bar or cast steel	Arch bar	Cast steel	Cast steel	Cast steel	Cast steel	Cast steel	Cast steel	Cast steel	Cast steel	Cast steel	Cast steel
Truck bolster, type and material	Cast steel	Cast steel	Cast steel	Cast steel	Cast steel	Cast steel	Cast steel	Cast steel	Cast steel	Cast steel	Cast steel
Weight of each truck	7,000 lb.	5,200 lb.	5,200 lb.	5,200 lb.	6,150 lb.	7,000 lb.	7,000 lb.	6,765 lb.	6,765 lb.	7,043 lb.	7,043 lb.
Wheels, material	Cast iron	Cast iron	Cast iron	Cast iron	Cast iron	Cast iron	Cast iron	Cast iron	Cast iron	Cast iron	Cast iron
Material of journal boxes	Malleable	Malleable	Malleable	Malleable	Malleable	Malleable	Malleable	Malleable	Malleable	Malleable	Malleable
Single or double deck	Double	Double	Double	Single	Single	Single	Single	Single	Single	Single	Single

** Posts, 4 1/2 in. x 2 1/2 in. Trusses, 3 in. x 3 in. angle. Sole plate, 5 in. x 3 in. angle.

EXAMPLES OF RECENT DESIGN IN CHAIR CARS

Table with 10 columns: Material, Vestibule, Seating capacity, Length, Width, Height, etc. Each column lists specifications for various components of chair cars, such as steel frame, vestibule, seating capacity, and structural details. The table is organized into sections for different parts of the car, including the body, vestibule, and interior.

EXAMPLES OF RECENT DESIGN IN VESTIBULE STEEL COACHES

<p>Railroad</p> <p>Light weight</p> <p>Seating capacity</p> <p>Length, over body and sills</p> <p>Length, over bolsters</p> <p>Length, inside to inside of corner knuckles</p> <p>Width, inside lining</p> <p>Width, over side sills</p> <p>Width, over eaves</p> <p>Height, extreme over all</p> <p>Height, highest point</p> <p>Height and width of door opening</p> <p>End doors, wood or steel</p> <p>Height, top of rail to eaves</p> <p>Height, top of rail to top of floor</p> <p>Sides, top of floor to top of roof</p> <p>Size of side frame members</p> <p>Vestibule end, vertical members</p> <p>Body end, vertical members</p> <p>Center sills, type</p> <p>Cover plates, length and thickness</p> <p>Angles, reinforcing, in center sills</p> <p>Number, position and size</p> <p>Side sills, type</p> <p>Body bolsters, type and material</p> <p>Cross-braces, number</p> <p>Drift, rope, spring or friction</p> <p>Roof, type</p> <p>Windows</p> <p>Thickness, of walls</p> <p>Insulating material</p> <p>Walls insulated</p> <p>Dead weight per passenger</p> <p>Number of windows per side</p> <p>Windows wash</p> <p>Width of aisle</p> <p>Aisle strip (loose or depressed)</p> <p>Smoking room, with or without</p> <p>Number of toilets</p> <p>Interior finish (wood or steel)</p> <p>Heating system</p> <p>Cube ft. of contents per sq. ft. radiating surface</p> <p>Ventilation system</p> <p>Lighting system</p> <p>Light center of upper deck or side</p> <p>Lighting, direct or indirect</p> <p>Total wheel base</p> <p>Distance, center to center of body bolsters</p> <p>Truck wheel base</p> <p>Type of truck</p> <p>Wheels, material and size</p> <p>Type of brakes</p> <p>Weight of each truck</p> <p>Width of trap door, opening</p>	<p>Errie</p> <p>134,500 lb.</p> <p>86</p> <p>61 ft. 8 in.</p> <p>72 ft. 7 1/2 in.</p> <p>62 ft. 6 3/4 in.</p> <p>72 ft. 1 1/2 in.</p> <p>81 ft. 0 in.</p> <p>9 ft. 1 3/4 in.</p> <p>9 ft. 7 3/4 in.</p> <p>10 ft. 1 3/4 in.</p> <p>10 ft. 1 3/4 in.</p> <p>9 ft. 5 3/4 in.</p> <p>6 ft. 5 3/4 in.</p> <p>2 ft. 2 1/4 in.</p> <p>11 ft. 1 1/2 in.</p> <p>10 ft. 3 3/8 in.</p> <p>4 ft. 6 3/4 in.</p> <p>4 ft. 6 3/4 in.</p> <p>5 in. x 2 1/2 in.</p> <p>4 9/16 in. beams, I-beams and channels and I-beam</p> <p>Pressed steel</p> <p>8-in. 16.25 lb. ch.</p> <p>67 ft. 10 in. x 3/8 in.</p> <p>3 Bottom, 4 in. x 3 1/2 in. x 3/8 in.</p> <p>3 1/2 in. x 3 3/4 in. x 3/8 in.</p> <p>3 in. x 3 3/4 in. x 3/8 in.</p> <p>Top, 4 in. x 3 1/2 in. x 3/8 in.</p> <p>Bottom, each 4 in. x 3 in. x 3/8 in.</p> <p>Side 3 in. x 3 1/2 in. x 3/8 in.</p> <p>4-in. plate</p> <p>Build-up structural steel</p> <p>Friction</p> <p>Clerestory</p> <p>Steel</p> <p>Flaxman</p> <p>Outside</p> <p>1,000 lb.</p> <p>22</p> <p>Single</p> <p>Wood</p> <p>2 ft. 0 in.</p> <p>2 ft. 0 in.</p> <p>Depressed</p> <p>Without</p> <p>1</p> <p>Steel</p> <p>Ward</p> <p>20</p> <p>Utility</p> <p>Electric, axle</p> <p>Center</p> <p>Direct</p> <p>64 ft. 3 1/2 in.</p> <p>55 ft. 7 1/2 in.</p> <p>47 ft. 7 1/2 in.</p> <p>10 ft. 6 in.</p> <p>6-wheel</p> <p>Special cast iron</p> <p>33 in.</p> <p>Classp</p> <p>12,500 lb.</p> <p>28 in.</p>	<p>A. T. & S. F.</p> <p>139,700 lb.</p> <p>83</p> <p>70 ft. 0 in.</p> <p>81 ft. 7 in.</p> <p>69 ft. 3 3/4 in.</p> <p>77 ft. 7 3/4 in.</p> <p>9 ft. 8 1/4 in.</p> <p>9 ft. 7 3/4 in.</p> <p>10 ft. 1 3/8 in.</p> <p>10 ft. 1 3/4 in.</p> <p>9 ft. 5 3/4 in.</p> <p>6 ft. 6 1/2 in. x 2 ft. 4 in.</p> <p>Wood</p> <p>11 ft. 3 3/8 in.</p> <p>10 ft. 1 3/8 in.</p> <p>4 ft. 6 3/4 in.</p> <p>4 ft. 6 3/4 in.</p> <p>2 in. x 2 in. x 1/2 in. steel</p> <p>Channels and I-beams</p> <p>Pressed steel</p> <p>8-in. 16.25 lb. ch.</p> <p>68 ft. 8 in. x 3/4 in.</p> <p>3 Top, each side 3 1/2 in. x 3 in. x 3/8 in.</p> <p>3 in. x 3 3/4 in. x 3/8 in.</p> <p>Bottom, each 4 in. x 3 in. x 3/8 in.</p> <p>4-in. plate</p> <p>Build-up structural steel</p> <p>Friction</p> <p>Clerestory</p> <p>Steel</p> <p>Flaxman</p> <p>Outside</p> <p>1,000 lb.</p> <p>22</p> <p>Single</p> <p>Wood</p> <p>2 ft. 0 in.</p> <p>2 ft. 0 in.</p> <p>Depressed</p> <p>Without</p> <p>2</p> <p>Steel</p> <p>Chicago</p> <p>20</p> <p>Utility</p> <p>Electric, axle</p> <p>Center</p> <p>Direct</p> <p>64 ft. 3 1/2 in.</p> <p>59 ft. 9 1/2 in.</p> <p>47 ft. 7 1/2 in.</p> <p>10 ft. 6 in.</p> <p>6-wheel</p> <p>Special cast iron</p> <p>33 in.</p> <p>Classp</p> <p>12,500 lb.</p> <p>28 in.</p>	<p>Can. Nor.</p> <p>145,000 lb.</p> <p>78</p> <p>72 ft. 6 in.</p> <p>80 ft. 8 3/4 in.</p> <p>71 ft. 6 3/4 in.</p> <p>80 ft. 2 3/4 in.</p> <p>88 ft. 9 3/8 in.</p> <p>82 ft. 9 3/8 in.</p> <p>8 ft. 1 3/8 in.</p> <p>9 ft. 3 3/8 in.</p> <p>10 ft. 1 3/8 in.</p> <p>10 ft. 4 3/8 in.</p> <p>10 ft. 3 3/8 in.</p> <p>9 ft. 7 3/8 in.</p> <p>5 ft. 6 3/8 in.</p> <p>2 ft. 7 1/2 in. x 2 ft. 3 in.</p> <p>Wood</p> <p>11 ft. 4 3/4 in.</p> <p>4 ft. 6 3/4 in.</p> <p>4 ft. 6 3/4 in.</p> <p>5 in. x 2 in. x 1/2 in. angle</p> <p>Channels and I-beams</p> <p>Pressed steel</p> <p>8-in. 16.25 lb. ch.</p> <p>74 ft. 10 1/2 in. x 3/8 in.</p> <p>4 Top, 5 in. x 3 1/2 in. x 3/8 in.</p> <p>3 1/2 in. x 3 3/4 in. x 3/8 in.</p> <p>Bottom, 3 in. x 3 in. x 3/8 in.</p> <p>Z-bar</p> <p>Pressed steel</p> <p>Friction</p> <p>Clerestory</p> <p>Steel</p> <p>Flaxman</p> <p>Inside</p> <p>1,540 lb.</p> <p>24</p> <p>Wood</p> <p>2 ft. 5 3/8 in.</p> <p>None</p> <p>2</p> <p>Steel</p> <p>Vapor</p> <p>Automatic</p> <p>Electric, axle</p> <p>Center</p> <p>Direct</p> <p>69 ft. 4 1/2 in.</p> <p>58 ft. 4 1/2 in.</p> <p>10 ft. 6 in.</p> <p>6-wheel</p> <p>Steel</p> <p>36 in.</p> <p>Clasp</p> <p>21,500 lb.</p> <p>2 ft. 9 1/2 in.</p>	<p>C. M. & St. P.</p> <p>141,000 lb.</p> <p>78</p> <p>72 ft. 6 in.</p> <p>80 ft. 2 3/4 in.</p> <p>71 ft. 7 1/2 in.</p> <p>79 ft. 3 3/4 in.</p> <p>9 ft. 3 3/4 in.</p> <p>10 ft. 1 in.</p> <p>10 ft. 4 3/8 in.</p> <p>10 ft. 6 in.</p> <p>9 ft. 10 1/2 in.</p> <p>6 ft. 4 in. x 2 ft. 3 in.</p> <p>Wood</p> <p>11 ft. 1 3/8 in.</p> <p>4 ft. 6 3/4 in.</p> <p>4 ft. 6 3/4 in.</p> <p>5 in. x 2 in. x 1/2 in. angle</p> <p>Channels and I-beams</p> <p>Pressed steel</p> <p>8-in. 16.25 lb. ch.</p> <p>74 ft. 10 1/2 in. x 3/8 in.</p> <p>4 Top, 4 in. x 3 1/2 in. x 3/8 in.</p> <p>3 1/2 in. x 3 3/4 in. x 3/8 in.</p> <p>Bottom, 3 in. x 3 in. x 3/8 in.</p> <p>Z-bar</p> <p>Pressed steel</p> <p>Friction</p> <p>Clerestory</p> <p>Steel</p> <p>Flaxman</p> <p>Inside</p> <p>1,808 lb.</p> <p>21</p> <p>Wood</p> <p>2 ft. 2 in.</p> <p>None</p> <p>2</p> <p>Steel</p> <p>Steam</p> <p>Deck sash</p> <p>Electric and oil, head-end</p> <p>Center</p> <p>Direct</p> <p>68 ft. 0 in.</p> <p>56 ft. 6 in.</p> <p>10 ft. 6 in.</p> <p>6-wheel</p> <p> Rolled steel</p> <p>36 in.</p> <p>Single shoe</p> <p>44,000 lb.</p> <p>2 ft. 7 in.</p>	<p>S. A. L.</p> <p>135,900 lb.</p> <p>99</p> <p>72 ft. 4 1/2 in.</p> <p>79 ft. 2 3/4 in.</p> <p>71 ft. 8 3/8 in.</p> <p>9 ft. 1 in.</p> <p>9 ft. 9 3/4 in.</p> <p>9 ft. 11 1/2 in.</p> <p>10 ft. 3 3/4 in.</p> <p>10 ft. 6 7/8 in.</p> <p>9 ft. 5 3/4 in.</p> <p>6 ft. 1 in. x 2 ft. 3 in.</p> <p>Wood</p> <p>11 ft. 3 3/4 in.</p> <p>4 ft. 6 3/4 in.</p> <p>4 ft. 6 3/4 in.</p> <p>5 in. x 2 in. x 1/2 in. angle</p> <p>Channels and I-beams</p> <p>Pressed steel</p> <p>8-in. 16.25 lb. ch.</p> <p>74 ft. 10 1/2 in. x 3/8 in.</p> <p>2 Top, 3 1/2 in. x 3 1/2 in. x 3/8 in.</p> <p>3 1/2 in. x 3 3/4 in. x 3/8 in.</p> <p>Bottom, 3 1/2 in. x 3 3/4 in. x 3/8 in.</p> <p>Z-bars and angles</p> <p>Cast steel, double</p> <p>Friction</p> <p>Clerestory</p> <p>Steel</p> <p>Flaxman</p> <p>Both</p> <p>1,365 lb.</p> <p>23</p> <p>Single</p> <p>Wood</p> <p>2 ft. 1 in.</p> <p>None</p> <p>2</p> <p>Steel</p> <p>Vapor</p> <p>Garland</p> <p>Electric, axle</p> <p>Center</p> <p>Direct</p> <p>65 ft. 8 1/4 in.</p> <p>54 ft. 8 1/4 in.</p> <p>10 ft. 6 in.</p> <p>6-wheel</p> <p> Rolled steel</p> <p>36 in.</p> <p>Single shoe</p> <p>21,000 lb.</p> <p>2 ft. 3 in.</p>	<p>C. R. & S. P.</p> <p>135,900 lb.</p> <p>86</p> <p>70 ft. 5 3/4 in.</p> <p>79 ft. 5 3/4 in.</p> <p>70 ft. 0 in.</p> <p>79 ft. 2 3/4 in.</p> <p>9 ft. 1 1/4 in.</p> <p>10 ft. 8 in.</p> <p>10 ft. 0 in.</p> <p>10 ft. 6 7/8 in.</p> <p>9 ft. 7 in.</p> <p>6 ft. 7 in. x 2 ft. 4 in.</p> <p>Steel</p> <p>11 ft. 3 3/4 in.</p> <p>4 ft. 6 3/4 in.</p> <p>4 ft. 6 3/4 in.</p> <p>5 in. x 2 in. x 1/2 in. angle</p> <p>Channels and I-beams</p> <p>Pressed steel</p> <p>8-in. 16.25 lb. ch.</p> <p>74 ft. 10 1/2 in. x 3/8 in.</p> <p>4 Top, 3 1/2 in. x 3 1/2 in. x 3/8 in.</p> <p>3 1/2 in. x 3 3/4 in. x 3/8 in.</p> <p>Bottom, 3 1/2 in. x 3 3/4 in. x 3/8 in.</p> <p>Z-bars and angles</p> <p>Cast steel, double</p> <p>Friction</p> <p>Clerestory</p> <p>Steel</p> <p>Flaxman</p> <p>Both</p> <p>1,365 lb.</p> <p>20</p> <p>Double</p> <p>Wood</p> <p>2 ft. 2 1/2 in.</p> <p>None</p> <p>2</p> <p>Steel</p> <p>Vapor</p> <p>Garland</p> <p>Electric, axle</p> <p>Center</p> <p>Direct</p> <p>65 ft. 8 1/4 in.</p> <p>54 ft. 8 1/4 in.</p> <p>10 ft. 6 in.</p> <p>6-wheel</p> <p> Rolled steel</p> <p>36 in.</p> <p>Single shoe</p> <p>21,000 lb.</p> <p>2 ft. 3 in.</p>	<p>E. P. & S. W.</p> <p>137,340 lb.</p> <p>86</p> <p>70 ft. 0 in.</p> <p>78 ft. 10 1/2 in.</p> <p>69 ft. 2 1/2 in.</p> <p>78 ft. 4 in.</p> <p>9 ft. 4 in.</p> <p>10 ft. 9 in.</p> <p>10 ft. 6 7/8 in.</p> <p>9 ft. 7 in.</p> <p>6 ft. 8 in. x 2 ft. 4 in.</p> <p>Steel</p> <p>11 ft. 3 3/4 in.</p> <p>4 ft. 6 3/4 in.</p> <p>4 ft. 6 3/4 in.</p> <p>5 in. x 2 in. x 1/2 in. angle</p> <p>Channels and I-beams</p> <p>Pressed steel</p> <p>8-in. 16.25 lb. ch.</p> <p>74 ft. 10 1/2 in. x 3/8 in.</p> <p>4 Top, 3 in. x 3 in. x 3/8 in.</p> <p>3 in. x 3 3/4 in. x 3/8 in.</p> <p>Bottom, 3 in. x 3 in. x 3/8 in.</p> <p>Z-bars and angles</p> <p>Cast steel, double</p> <p>Friction</p> <p>Clerestory</p> <p>Steel</p> <p>Flaxman</p> <p>Both</p> <p>1,365 lb.</p> <p>24</p> <p>Double</p> <p>Wood</p> <p>2 ft. 1 in.</p> <p>None</p> <p>2</p> <p>Steel</p> <p>Chicago, steam</p> <p>Garland</p> <p>Electric, axle</p> <p>Center</p> <p>Direct</p> <p>64 ft. 6 in.</p> <p>54 ft. 0 in.</p> <p>10 ft. 6 in.</p> <p>6-wheel</p> <p> Steel</p> <p>36 in.</p> <p>Single shoe</p> <p>21,000 lb.</p> <p>2 ft. 7 3/8 in.</p>	<p>E. L. & W.</p> <p>106,000 lb.</p> <p>78</p> <p>70 ft. 5 3/4 in.</p> <p>59 ft. 11 1/2 in.</p> <p>69 ft. 5 3/4 in.</p> <p>8 ft. 11 3/4 in.</p> <p>8 ft. 11 3/4 in.</p> <p>10 ft. 0 in.</p> <p>10 ft. 0 in.</p> <p>9 ft. 7 in.</p> <p>6 ft. 7 in. x 2 ft. 4 in.</p> <p>Steel</p> <p>11 ft. 3 3/4 in.</p> <p>4 ft. 6 3/4 in.</p> <p>4 ft. 6 3/4 in.</p> <p>5 in. x 2 in. x 1/2 in. angle</p> <p>Channels and I-beams</p> <p>Pressed steel</p> <p>8-in. 16.25 lb. ch.</p> <p>74 ft. 10 1/2 in. x 3/8 in.</p> <p>4 Top, 3 in. x 3 in. x 3/8 in.</p> <p>3 in. x 3 3/4 in. x 3/8 in.</p> <p>Bottom, 3 in. x 3 in. x 3/8 in.</p> <p>Z-bars and angles</p> <p>Cast steel, double</p> <p>Friction</p> <p>Clerestory</p> <p>Steel</p> <p>Flaxman</p> <p>Both</p> <p>1,365 lb.</p> <p>20</p> <p>Double</p> <p>Wood</p> <p>2 ft. 2 1/2 in.</p> <p>None</p> <p>2</p> <p>Steel</p> <p>Chicago, steam</p> <p>Garland</p> <p>Electric, axle</p> <p>Center</p> <p>Direct</p> <p>64 ft. 6 in.</p> <p>54 ft. 0 in.</p> <p>10 ft. 6 in.</p> <p>6-wheel</p> <p> Steel</p> <p>36 in.</p> <p>Single shoe</p> <p>21,000 lb.</p> <p>2 ft. 7 3/8 in.</p>
---	---	---	--	--	---	--	---	---

* Top, 30 in. x 1/2 in.; web, 25 1/2 in. x 3/8 in.

EXAMPLES OF RECENT DESIGN IN VESTIBULE STEEL COACHES (Continued)

	L. & N.	N. & W.	B. & O.	B. & M.	N. Y., N. H. & H.	Union Pac.	Union Pac.	I. C.	S. P.	C. & O.
Light weight	139,200 lb.	137,500 lb.	135,000 lb.	118,500 lb.	122,400 lb.	104,500 lb.	132,000 lb.	88	106,300 lb.	138,166 lb.
Seating capacity	80	78	80	88	80	72	84 and 81	88	73	85
Length, over body and sills	79 ft. 0 in.	70 ft. 8 1/2 in.	70 ft. 0 in.	70 ft. 3 1/2 in.	70 ft. 3 1/2 in.	59 ft. 10 in.	79 ft. 0 in.	71 ft. 11 1/8 in.	59 ft. 10 in.	70 ft. 0 in.
Length, over buffers	79 ft. 3 1/4 in.	80 ft. 1 1/8 in.	75 ft. 10 3/4 in.	80 ft. 3 1/4 in.	80 ft. 3 1/4 in.	69 ft. 1 in.	79 ft. 0 in.	70 ft. 11 7/8 in.	69 ft. 5 1/8 in.	77 ft. 4 in.
Length, inside of corner knuckles	78 ft. 4 in.	69 ft. 5 1/2 in.	75 ft. 0 in.	69 ft. 1 in.	69 ft. 1 in.	68 ft. 9 1/4 in.	79 ft. 0 in.	71 ft. 1 1/8 in.	69 ft. 5 1/8 in.	77 ft. 4 in.
Width, inside lining	8 ft. 11 3/4 in.	79 ft. 3 1/4 in.	79 ft. 4 in.	79 ft. 11 1/8 in.	78 ft. 8 1/4 in.	68 ft. 8 1/4 in.	78 ft. 8 1/4 in.	8 ft. 10 1/4 in.	68 ft. 6 3/8 in.	78 ft. 4 1/4 in.
Width, over side sills	10 ft. 0 in.	9 ft. 9 in.	9 ft. 9 in.	9 ft. 2 in.	9 ft. 3 1/8 in.	9 ft. 1 1/2 in.	9 ft. 1 1/2 in.	9 ft. 9 5/8 in.	9 ft. 1 1/8 in.	9 ft. 1 1/8 in.
Width, over eaves	10 ft. 0 in.	10 ft. 0 in.	10 ft. 3 8 in.	9 ft. 10 3/8 in.	9 ft. 10 3/8 in.	9 ft. 9 5/8 in.	9 ft. 9 5/8 in.	10 ft. 0 in.	9 ft. 9 5/8 in.	9 ft. 9 3/4 in.
Width, extreme, over all	10 ft. 3 3/8 in.	10 ft. 1 1/4 in.	9 ft. 11 3/4 in.	10 ft. 1 1/4 in.	10 ft. 1 1/4 in.	9 ft. 11 7/8 in.	10 ft. 1 1/4 in.	10 ft. 1 1/8 in.	9 ft. 11 7/8 in.	10 ft. 1 1/4 in.
Height, top of floor to bottom of carline, highest point	9 ft. 5 21/32 in.	6 ft. 11 1/8 in.	9 ft. 2 1/4 in.	9 ft. 1 1/8 in.	9 ft. 2 1/4 in.	10 ft. 3 in.	9 ft. 3 in.	9 ft. 1 1/8 in.	9 ft. 5 3/8 in.	9 ft. 7 in.
Height and width of floor opening	6 ft. 7 1/2 in. x 2 ft. 4 in.	6 ft. 7 1/2 in. x 2 ft. 4 in.	6 ft. 9 1/2 in. x 2 ft. 4 in.	6 ft. 6 1/2 in. x 2 ft. 1 in.	6 ft. 9 1/2 in. x 2 ft. 4 in.	9 ft. 3 1/8 in. x 2 ft. 3 in.	6 ft. 8 in. x 2 ft. 3 in.	6 ft. 6 1/2 in. x 2 ft. 4 in.	6 ft. 8 in. x 2 ft. 4 in.	6 ft. 8 in. x 2 ft. 4 in.
End doors, wood or steel	Wood	Steel	Wood	Wood	Wood	Wood	Wood	Wood	Wood	Steel
Height, top of rail to eaves	11 ft. 3 in.	11 ft. 3 in.	11 ft. 1 1/8 in.	10 ft. 11 1/2 in.	10 ft. 11 1/2 in.	11 ft. 7 8 in.	11 ft. 7 8 in.	10 ft. 10 1/8 in.	11 ft. 7 8 in.	11 ft. 3 in.
Height, top of floor to top of roof	4 ft. 6 5/8 in.	4 ft. 4 1/8 in.	3 ft. 8 in.	4 ft. 3 3/8 in.	4 ft. 3 3/8 in.	4 ft. 3 3/8 in.	4 ft. 5 3/8 in.	4 ft. 5 3/8 in.	4 ft. 5 3/8 in.	4 ft. 3 in.
Side frame members	Pressed steel ch. 3 1/2 in. x 3 1/2 in.	Pressed channel 3 1/2 in. x 3 1/2 in.	Pressed channel 1 1/2 in.	Pressed ch. 4 in. x 1 1/2 in.	Pressed ch. 1 1/2 in. x 3 1/4 in.	Angles and T. 8-3 iron, 2 1/2 in. x 1 1/2 in.	Angles and T. 2 1/2 in. x 1 1/2 in.	Angles and T. 2 1/2 in. x 1 1/2 in.	Angle and T. 4 in. x 1 1/2 in.	Channels 4 in.
Size of side frame members	3 1/2 in. x 4 in.	3 1/2 in. x 3 in.	1 1/2 in.	4 in. x 1 1/2 in.	1 1/2 in. x 3 1/4 in.	8-3 iron, 2 1/2 in. x 1 1/2 in.	2 1/2 in. x 1 1/2 in.	2 1/2 in. x 1 1/2 in.	Belt track, 3 1/2 in. x 1 1/2 in.	
Vestibule end, vertical members	6 in. I-beams	6 in. I-beams	6 in. I-beams	6 in. 23.0 lb. I-beams	9 in. 35 lb. I-beams	6 in. I-beams, pressed steel corner posts, and Z-bars and angles	6 in. I-beams, pressed steel corner posts, and Z-bars and angles	6 in. I-beams, pressed steel corner posts, and Z-bars and angles	6 in. I-beams, pressed steel corner posts, and Z-bars and angles	6 in. I-beams
Body end, vertical members	Z-bar and I-beams	Z-bar	I-beams and Z-bars	I-beams and Z-bars and angles	I-beams and Z-bars	I-beams and Z-bars and angles	I-beams and Z-bars and angles	I-beams and Z-bars and angles	I-beams and Z-bars and angles	I-beams
Center sills, type	Fishbelly	Fishbelly	Fishbelly	Fishbelly	Fishbelly	Fishbelly	Fishbelly	Fishbelly	Fishbelly	Fishbelly
Cover plates, length and thickness	49 ft. 2 1/2 in. x 26 in. x 1/2 in.	66 ft. 7 1/2 in. x 1 1/2 in.	69 ft. 4 in. x 3 1/2 in.	50 ft. 10 in. x 3 1/2 in.	12 in. 40 lb. ch. 1/8 in. thick	53 ft. 1 in. x 22 in. x 1/4 in.	53 ft. 1 in. x 22 in. x 1/4 in.	2-51 ft. 1 1/8 in. x 3 in.	49 ft. 2 1/2 in. x 1 1/2 in.	49 ft. 2 1/2 in. x 1 1/2 in.
Angles, reinforcing, in corner sills	None	None	None	None	None	None	None	None	None	None
Number, position and size	2 Top, 4 Bottom, 3 in. x 3 1/2 in.	2 Top, 4 Bottom, 3 in. x 3 1/2 in.	2 Top, 4 Bottom, 3 in. x 3 1/2 in.	2 Top, 5 in. x 3 1/2 in. x 3 1/2 in.	None	None	None	2 Top, 4 in. x 3 in. x 3 1/2 in.	None	2 Top, 5 in. x 3 in. x 3 1/2 in.
Side sills, type	6 in. x 4 in. x 1/4 in. angles	6 in. x 3 1/2 in. x 3/8 in. angles	3 1/2 in. x 3 1/2 in. x 3/8 in. angles	6 in. x 3 1/2 in. x 3/8 in. angles	Flanged angles	6 in. x 3 1/2 in. x 3/8 in. angles	6 in. x 3 1/2 in. x 3/8 in. angles	8 in. x 3 1/2 in. x 3/8 in. angles	6 in. x 3 1/2 in. x 3/8 in. angles	5 in. x 3 in. x 3/8 in.
Body bolsters, type and material	Double, cast steel	Double, cast steel	Double, cast steel	Commonwealth cast steel	Built-up, double, steel plate	Single, cast st.	Single, cast st.	Double, cast st.	Single, cast st.	Commonwealth cast steel
Cross-braces, number	3	3	3	2	2	2	2	40	2	2
Draft gear, spring or friction	Friction	Friction	Friction	Friction	Friction	Friction	Friction	Friction	Friction	Friction
Roof, type	Clerestory	Clerestory	Clerestory	Clerestory	Clerestory	Clerestory	Clerestory	Clerestory	Clerestory	Clerestory
Carlines	Steel	Steel	Steel	Steel	Steel	Steel	Steel	Steel	Steel	Steel
Thickness of walls	5 1/4 in.	4 1/4 in.	4 1/4 in.	3 7/8 in. and 4 1/4 in.	3 7/8 in. and 4 1/4 in.	5 1/8 in.	5 1/8 in.	4 7/8 in.	4 1/8 in. and 5 1/8 in.	4 1/8 in. and 5 1/8 in.
Insulating material	Nycinel	Salamander	Flaxium	Salamander	Salamander	Salamander	Salamander	Salamander	Salamander	Salamander
Walls insulated	Outside	Both	Outside	Outside	Outside	Outside	Outside	Outside	Outside	Inside
Lead weight per passenger	1,740 lb.	1,763 lb.	1,695 lb.	1,347 lb.	1,389 lb.	1,630 and 1,572 lb.	1,630 and 1,572 lb.	1,625 lb.	1,625 lb.	1,625 lb.
Number of windows per side	22	22	22	22	22	22	22	33	19	31
Windows, sash	Double	Single	Single	Single	Single	Double	Double	Single	Double	Double
Width of aisle	1 ft. 10 1/4 in.	2 ft. 3 1/2 in.	2 ft. 3 1/2 in.	2 ft. 2 1/2 in.	2 ft. 2 in.	2 ft. 2 in.	2 ft. 2 in.	2 1/2 in.	2 ft. 2 in.	2 ft. 1 1/4 in.
Aisle strip, those on depressed	None	None	None	None	None	Depressed	Depressed	None	None	None
Smoking room, with or without	With	With	Without	Without	Without	With & without	With & without	Without	Without	Without
Number of toilet	2	2	2	2	2	2	2	2	2	2
Interior finish (wood or steel)	Wood	Steel	Wood	Steel	Alusite and st.	Steel	Steel	Wood	Steel	Steel
Heating system	Chicago, vapor	Standard, vapor	Steam heat	Standard vapor	Ideal steam	Direct steam and vapor	Direct steam and vapor	Standard	Direct steam vapor	Ward
Cubic ft. of contents per 80-ft. rating surface	16	100	Ratio 15 to 1	11.55	Automatic	13	13	13	13	13
Ventilation system	Truck sash	Ward	Motor, Peerless	Automatic	Automatic	Utility	Utility	Utility	Globe	Garland
Lighting system	Asile	Electric, axle	Electric, axle	Electric, axle	Electric, axle	Gas and electric head end	Gas and electric head end	Asile	Electric, axle	Electric, axle
Light center of upper deck or side	Center	Center and side	Center	Center	Center	Center	Center	Center	Center	Side
Lighting, direct or indirect	Direct	65 Direct	Direct	Direct	Direct	Direct	Direct	Semi-direct	Direct	Direct
Position, centers of body bolsters	64 ft. 6 in.	54 ft. 6 in.	53 ft. 0 in.	62 ft. 6 in.	62 ft. 6 in.	52 ft. 6 in.	52 ft. 6 in.	55 ft. 11 1/8 in.	52 ft. 6 in.	64 ft. 6 in.
Track wheel base of body bolsters	10 ft. 6 in.	10 ft. 6 in.	11 ft. 0 in.	8 ft. 0 in.	8 ft. 0 in.	11 ft. 0 in.	11 ft. 0 in.	11 ft. 0 in.	48 ft. 0 in.	54 ft. 0 in.
Type of truck	4-wheel	4-wheel	6-wheel	4-wheel	4-wheel	4-wheel	4-wheel	6-wheel	4-wheel	10 ft. 6 in.
Wheels, material and size	36 in.	36 in.	36 in.	36 in.	36 in.	36 in.	36 in.	36 in.	36 in.	36 in.
Type of brakes	Single shoe	Single shoe	Chasp	Chasp	Chasp	Single shoe	Single shoe	Chasp	Single shoe	Single shoe
Weight of each truck	21,020 lb.	20,500 lb.	21,850 lb.	15,150 lb.	17,500 lb.	23,400 lb.	23,400 lb.	22,500 lb.	23,400 lb.	23,400 lb.
Width of trap-floor opening	2 ft. 7 1/8 in.	2 ft. 3 in.	2 ft. 11 1/8 in.	3 ft. 1 1/4 in.	2 ft. 8 in.	2 ft. 8 in.	2 ft. 8 in.	2 ft. 9 in.	2 ft. 8 in.	2 ft. 8 1/4 in.

* 2 1/2 in. x 3 in. x 3/8 in. T-irons, 4 in. x 1 1/2 in. x 1/8 in. corner posts.

Shop Practice

TOOLS FOR MAKING LOCOMOTIVE SAFETY CHAINS

BY M. C. WHELAN
Foreman Blacksmith, St. Louis & San Francisco, Kansas City, Mo.

As the government requires that the railways equip their engines and tenders with safety chains before July 1, 1917, every means by which this work can be done should be of interest. Those roads not equipped with heavy forging machines or drop hammers will find the following method of doing this work entirely satisfactory. The tools are made with but little machine work and most of the work in making the chains is done under the steam hammer. The tools are shown in the illustration. Nos. 1, 2 and 12 are used for making the clevis 3. No. 1 is a piece of machine steel used to form the dies 2-2 under the steam hammer. No. 12 is used to punch the 2 1-16-in. holes in the clevis ends. The material used for making the clevises is obtained from 1½ in. by 4½ in. and 1½ in. by 5 in. scrapped arch bars sheared to 12-in. and 13-in. lengths. With small furnaces

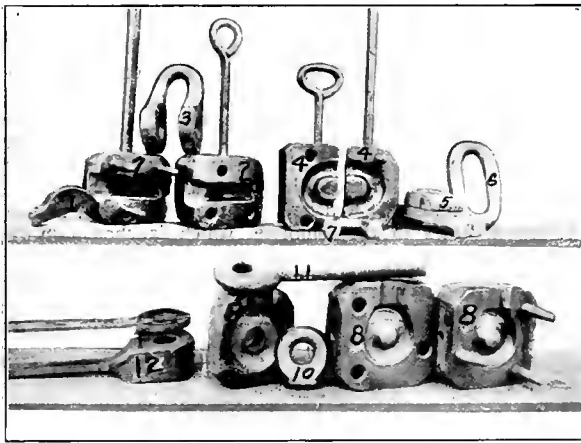

Forging Dies for Making Safety Chains

at least four of these clevises can be made per hour by one smith and two helpers.

Nos. 4, 5 and 7 are used for making the link 6. No. 5 is a tool used for scraping the rods prior to welding, and 4-4 are the dies used for welding the links. No. 7 is the forming piece used in making the dies 4-4. Nos. 8, 9 and 10 are used for making the eye bolt 11. No. 8 is the die for forming the head of the bolt and 9 is the guide for punching the hole through the web in the eye bolt head formed by the dies 8-8. No. 10 is the forming piece for making the dies 8-8. The guide pin holes in the dies 2 and 8 are formed by the following method: The space in each die is filled with melted lead which is allowed to cool. It is then removed and the respective halves soldered together. They are then replaced in the dies and the dies securely clamped together for drilling. This will insure the proper alignment of the guide pins and the receiving holes. A

1-in. hole is drilled through the bottom to within 1 in. of the top of the top die. A 13-16-in. hole is drilled through the remaining 1 in. of metal. The dies are then taken apart and the holes in the bottom dies are enlarged to 1 1-16-in. and the 13-16-in. holes in the top dies are counter-sunk. The guide pins are made from 1-in. material. The guide pin holes in dies 4-4 are drilled with simply the forming piece in place between the dies.

These tools will be found to do the work very satisfactorily where more improved methods are available. No machine work is required after forging except the cutting of the threads on the eye bolts. By the use of these tools a stock of clevises and eye bolts can be placed in store and with a stock of links bent in pneumatic machines on hand, the engines can be equipped with safety chains at short notice.

PNEUMATIC BOLT CLAMP

BY HOWARD W. STULL
Foreman Machine Shop, Philadelphia & Reading, Reading, Pa.

A pneumatic bolt chuck which has been used and proved to be very successful at the Philadelphia & Reading shops at Reading, Pa., is shown in the drawing. This chuck can be used as an attachment to a bolt threading machine for hold-

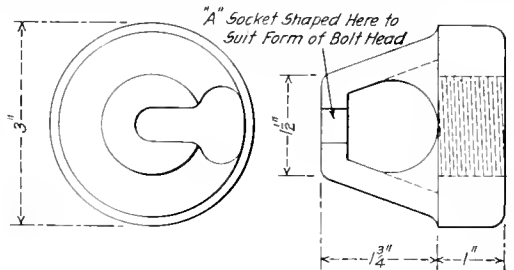

Detail of the Clamping Head

ing short size counter sunk and button headed bolts. As used by the Reading the chucks are mounted on a triple spindle 1½-in. National bolt cutter. The barrel of the chuck is placed in the jaws of the machine, which are tightened

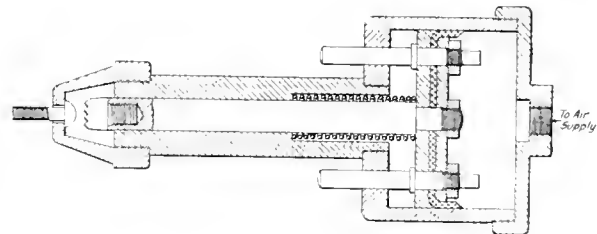

Sectional View of Air Cylinder and Clamp

down just as though they were holding a bolt to be threaded. The cylinder is then connected up through a 1½-in. three-way air cock to the nearest supply of compressed air.

The short sizes of counter sunk and button headed bolts are ordinarily very difficult to hold in the common grip of

a bolt cutter. The process is not only slow, but awkward. In this pneumatic chuck the bolt blanks are slipped in through the opening *A* in the side of the chuck. Air is then admitted into the cylinder, pushing the piston down. On the end of the clamping rod is a stop, which serves to hold the screw in position and keep it from revolving. It will be noted that a spring is provided on the non-pressure side of the cylinder to insure the freeing of the screw when the air pressure is released. There are also two guides on the non-pressure side of the piston that extend through the bottom end of the cylinder and prevent the piston and rod turning with the screw. It will be noted that the cap in which the screw is placed, screws on to the barrel of the chuck. In threading screws with heads of odd size and shape, all that is necessary is to exchange the cap for one that will accommodate them.

INDICATOR FOR PLACING JACKS

BY W. J. KELLY

When it is necessary in making repairs to freight or passenger cars, to jack up the body of the car, it is often difficult to tell whether the jack is placed exactly in a vertical

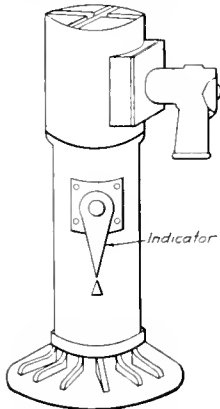

Simple Indicator for Setting Jacks

position, there often being differences of opinion as to this among men who are experienced in this class of work. In order to insure that the jack is set in a stable manner the following suggestion is offered. An indicator consisting of a plate curved to conform to the surface of the jack body should be made for attachment to the jack, with machine screws, a horizontal pin on the plate carrying a pointer at all times free to assume a

vertical position under the action of gravity. With two of these devices attached to the jack at points around the barrel 90 deg. apart, there would be no difficulty in checking up the position of the jack under all conditions.

A USE FOR OLD BOILER TUBES

BY "APEX"

Old boiler tubes can be made into good fence posts for wire fencing, those about 2 in. in diameter being most suitable for this purpose. One order for 15,000 posts was handled in the following manner:

The tubes were cut to length in a high speed friction saw at the rate of 200 per hour. They were then passed to a sensitive drill press to have the holes drilled for the wire. The first hole was drilled one inch from the end of the tube. The rest of the holes were spaced and drilled by the test of a jig. This jig has a pin in it which slips in the hole first drilled near the end of the tube. At the other end is a clip which slips over the tube and helps hold it in position. This clip is riveted on to the body of the jig, which is a piece of light strap-iron. The holes in the pattern should be drilled about $\frac{3}{8}$ in. or $\frac{1}{2}$ in. in diameter and they can then be fitted with steel bushings, boring a hole in the center large enough to take the drill used. The steel bushings can then be replaced as they wear too large.

FLANGING BOILER SHEETS COLD

BY E. P. FAIRCHILD

A tube sheet being flanged cold is shown in Fig. 1. This sheet, which is of $\frac{1}{2}$ -in. stock, was laid out and all the flue holes, rivet holes and staybolt holes punched. It was then brought to the press and flanged cold as shown in the photograph. After this operation it was taken to a furnace and annealed, the flue holes reamed and arch pipe holes drilled. No trouble has been experienced with cold flanged

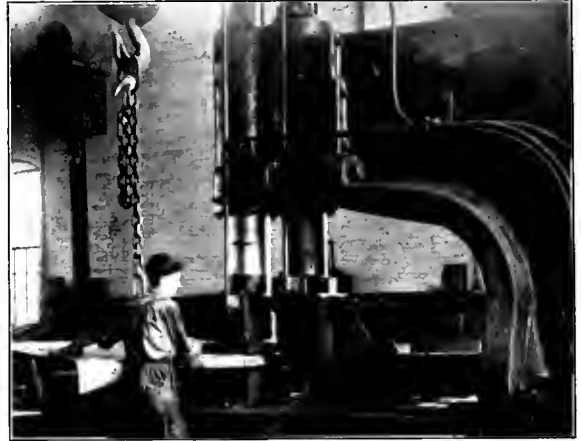

Fig. 1—Flanging a $\frac{1}{2}$ -In. Tube Sheet Cold

sheets. They may be welded or riveted in, either method giving good results. The cost of labor and material for the flue sheet completed was \$25.

Two firebox sheets are shown in Fig. 2. The firedoor opening has been flanged out with a $2\frac{1}{2}$ -in. inside radius flange. The large radius eliminates fire cracks; in fact, after many installations I have yet to find one cracked, using this radius. It will be noted that there are a number of $\frac{1}{2}$ -in. holes in the template, which is shown on the



Fig. 2—Template Used on Door Sheets After They Have Been Flanged Cold

left. These holes mark four different styles of door collars, one of which is shown laid out on the sheet to the right. The template is placed on the door sheet and the $\frac{3}{8}$ -in. set screws in the strap located in the door opening are so adjusted that the mud ring rivet holes in the sheet correspond with the mud ring rivet holes in the template. Whichever door sheet is wanted is then marked off through the $\frac{1}{4}$ -in. holes.

"FIRED"—FOR THE GOOD OF THE SERVICE

A Chapter in the Life Story of John McNally,
General Foreman of the Y. and A. Z. Railroad

BY HARVEY DE WITT WOLCOMB

"JOHN, we've got to make a change." It was the master mechanic who was speaking, and he paused and looked straight across his table at John McNally, the general foreman of the Y. and A. Z. Railroad at Greenfield.

John, the object of this remark, was the only other occupant of the room and he sat on the other side of a table of a style always found with other antiquated furniture in railroad offices. He wore a preoccupied look that comes to man or beast who, day after day, with never a break, carries on and on any hard, grinding task. He had been the general foreman at Greenfield for eleven years. Eleven years at a post, where there is more trouble and less appreciation than any other place on the railroad.

The master mechanic's voice began again and some note in it made John brace himself for an unusually severe reprimand. "After tonight there will be a younger man in charge of the Greenfield roundhouse."

Such an unexpected thing was like a thunderbolt out of a clear sky. Things had not been going right for some time, John knew, but that he should be "canned!" It was unthinkable. His eyes opened wide till the whites showed all around, as his gaze rested for a few moments on the set face of the master mechanic. His head then dropped forward on his chest as a smothered "My God" escaped his lips.

A picture of despair he was, until the injustice of it all aroused some of the old fighting spirit that had become blunted through eleven long, weary years of roundhouse grind.

"Do you realize," said John, first with halting speech, but gaining speed and courage as he went, "that I have been general foreman for the past eleven years and know every bolt and nut on all the engines coming into the terminal? The men all know me an' have worked so long under my direction that they work harder for me than they would for anyone else. While we have a few failures, we keep the total down to so few that our division makes as good a showin' as any other. Have you stopped to think that I have grown to be an old man in the service, yet am only 43?"

"All you say is only too true," replied the master mechanic.

"Then why am I kicked out so sudden?"

"You have not only grown old in the service, but you have become moss-covered as well. You have comparatively few engine failures, to be sure, but there's no improvement. With a younger and more up-to-date general foreman, our failures could be entirely eliminated. Your days of usefulness as our general foreman are over. We can't keep you at your present salary, but we intend to take care of you by giving you an easy job at the bench."

Realizing the disagreeable conference was over, poor old John McNally returned to his own little office in the roundhouse where he could think over all the details of this terrible blow. As he pondered over the question, he could not find any satisfactory answer as to what he should do. In the days gone by he had had several good offers of positions with other roads. He had been considered an efficient foreman and had built up quite a reputation, but now he was older and besides being "fired," account of being "old-fashioned," he realized only too well that any other road would not want a "cast off." He was "up against a stiff proposition." He recalled the days, twenty years ago, when he completed his apprenticeship and first started out as a full-fledged merchant; of his ambitions and how hard he had

worked to become successful—in fact he soon received the reputation of being a "horse" for work. He would turn out nearly as much work in one day as two ordinary mechanics. Sitting in the familiar time-worn office chair he pictured, as though it were yesterday, the day he was given charge of a gang, and how he had put his whole heart and soul into his job. And then after two years as a very successful shop foreman he had been promoted to the position of general foreman at the Greenfield roundhouse, which was an important main line terminal. While there were no large repair shops at this point, due to the importance of its location and the great number of engines handled, the position of general foreman meant something.

As his thoughts drifted back over the past eleven years of his career, he could now see that the first few years had slipped by very quickly—hardly noticed—for he was young and ambitious and could handle the many trying conditions with ease. During the later years he had worked harder and longer hours, besides being on duty practically every day in the year. He had neglected his home, his friends, his pleasures, till now he moved in an atmosphere that blotted out everything but "turning engines" and "shop troubles." After working twelve hours a day every day in the year he did not feel like dressing up and going out to any social doings with his wife or family. The few special occasions when he had gone out he felt like a fish out of water or a stranger in a foreign land. The people whom he met did not talk on subjects with which he was familiar.

All he knew, in fact all that was pleasant for him to talk about, was handling engines, and after a few half-hearted attempts at enjoying a social evening out, he had given up even trying and had positively refused to leave his own fire-side after completing his day's work. Anyway, wasn't he uncertain as to what time he would get home, and just as sure as he planned on going out, just so surely would there be a breakdown or something happen so that it would be very late when he left the roundhouse? Vacations had come to be a regular nightmare. As soon as he left town he would always remember some important piece of business he should have attended to before leaving, and when he returned he usually found everything so upset that it took him a long time to get things organized again as he wanted them.

Now he could see just where he stood. Like a fire horse that had outlived its days of usefulness he was being turned out to pasture for the rest of his natural days, a pensioner.

During the time he had lived in Greenfield he had bought his own home. It was not completely paid for but he had raised his family without going into debt very much. Once, when the company had offered to transfer him to another point he had refused to go. He had just begun buying his home and he did not like to take his children out of the schools where they were doing so well. Now he could see his mistake, for it had become understood that he did not wish to be moved and would not consider even a promotion. He was anchored. He knew it and so did his company.

Well! There was no use of crying over "spilled milk." He moved out of his chair and paced up and down the floor trying to shake off the gloom. Would he stay and take the disgrace of demotion with a steady job, or would he pull up stakes and strike out for a fresh start? This was what kept running over and over again through his mind.

The office was so small that he could walk only a few steps each way past his desk, one of those affairs with a

slanting top and so blackened with roundhouse grime that the character of the wood had long since faded. The walking helped him think. He would write to some of the friends he had made during the past few years and ask them to help him secure a job. He recalled, however, with a sinking feeling, a conversation he had just the other day with a friend who claimed that when a man holding a minor position was dropped, it would be very hard for him to secure another position, but if one of the "big bugs" was let out they could soon get another position for they were known and rated by the high positions they had held. As he thought over the list of men he knew, he could not pick out one man who would be of any assistance to him at this time. The only thing for him to do was to start out on his own hook and dig up a job.

Thoughts of having to move away from Greenfield fairly made him sick. When he remembered, however, how the company had robbed him of the best years of his life and now, because he was getting old, intended to set him back just where he had started, twenty years ago, he made up his mind to show them there was still some "kick" left in the old man.

However, it must be thought out from all sides. Here he had his home, and what few friends he could really class as true friends. His family had a certain standing in the community. Was it worth trying to start all over again at his age of life? No matter where he went, he was sure to end up with a roundhouse job for he had neglected to follow up any other branch of mechanics and had specialized on roundhouse work, and so was now unqualified to take up any other kind of a position. In fact, there was a doubt in his own mind if he could "make good" at any other point. Many of the other roads had late appliances with which he was totally unfamiliar. The Y. & A. Z. had not been an up-to-date road and he had not taken time to study along any other lines than those which affected his own work. He wasn't posted and, in fact, had fallen behind the great procession of progress.

The real facts of the case were that he was one of those old fogies who did not believe in magazines. Everything had to come to him by word of mouth or experience. He had no use for any article describing mechanical improvements. It was "d— nonsense." He always laughed at anything describing advanced ideas on roundhouse management, for, as he had always claimed, there was only one way to get experience in roundhouse management, and that one way was to get in "the harness" the same as he had been for the past eleven years. Yet now his long training was not bringing the results he had looked for. Actual experience was necessary to some extent, but it was far more necessary to keep one's eyes open so as to easily select the good points from the bad. If he hadn't been so sure of himself, he could have seen that for some time business wasn't going as smoothly as it should.

Old John stopped his restless pacing up and down; one comforting thought came to him to still the devils that tortured. The men about the plant would miss him. While he had not been considered an "easy" foreman, he had been a "just" man in his own opinion. He felt he held the loyalty and respect of every employee. What a shock for him when he went out to see if train 46's engine was ready to leave the house in time to take her train at the depot. That very morning the men had greeted him with a "good morning" or a friendly nod of recognition, but by this time they had received an inkling that "something was doing," so they fairly turned their backs on the faithful old soul as he went through the house.

This act made him feel a great deal worse than losing his position, for he could probably secure another place equally as good but it would take him long years to build up true friendships. He was just learning by bitter experience that

the people whom one befriends the most are the first ones to forget past favors. He did not know or realize that the deserving man needs no favors, for he earns and is worth all he gets. It is the undeserving or unfaithful man who seeks for and secures favors, and then when he sees his source of future favors cut off, he quickly looks for his new victim, forgetting the friend who has done so much for him in the past.

Talk about hurting pride! The snubs received were too much for him, and he told his clerk that he was going home for the balance of the day. As he left the roundhouse he suddenly remembered that in all his experiences at Greenfield he had never gone home early before and if he went home at this time his people would be alarmed. He did not want to tell them just now about losing his place, so where could he go? He wouldn't go back to the roundhouse nor would he go home, and as he had no particular friends down town he was a true "outcast," with nothing to do but walk the streets till his regular time to start for home. Would he stay or leave? The question kept coming back and back for solution.

At the supper table that night he electrified the entire family by remarking he intended to lay off the next day and make a visit to the large shops at Ridgewood, a trip he had planned for the past eight years but for which he had never found time. Casually asking the family if they would like to move over to Ridgewood he was dumbfounded to hear a dissenting voice from every member. In fact, they all positively refused to leave Greenfield, even his wife said that as they had been so long in Greenfield they had made many friends, and if they moved they would never get over their homesickness.

"Yes," he thought, "you have made friends, but how many of them are true friends?" Then when John remembered what was before him, he, too, was homesick, for like the great majority of railroad men who receive fairly good salaries, he had allowed his family many liberties which had used up his salary so that even his home was not all paid for, and if he was out of work very long it would place them in very embarrassing circumstances. What would he do? On one hand he would have to sacrifice his pride if he accepted the offer to work as a mechanic, while on the other he might have to sacrifice the livelihood of his family if he took a position at some other point. Would the fascination of his work and the thoughts of his family's comfort more than offset the damage to his pride? What was the use of trying to start all over again at his age?

Business at the Greenfield terminal went on the next morning just as if nothing had been changed. When a new notice was posted on the bulletin board, first among the crowd to read it was a mechanic with a familiar figure but wearing a brand new pair of overalls. For all you could tell from outside appearances he read the following notice with as much unconcern as any of the other employees about the plant:

"Effective this date, Mr. Thomas Carleton is hereby appointed General Foreman of the Greenfield roundhouse, in place of John McNally, who has been assigned to other duties."

ORIGIN OF THE LOCOMOTIVE STEAM WHISTLE.—On May 4, 1833, there occurred an accident that gave us the locomotive whistle. It was on a level crossing between Bagworth and Thornton in England. Stephenson's locomotive "Samson" ran into a market cart containing 50 pounds of butter and 80 dozen eggs. A meeting of the directors was called, and Stephenson's suggestion of a whistle blown by steam was adopted. He went at once to a musical instrument maker in Leicester, who constructed a steam trumpet, which ten days later was tried in the presence of the board of directors. In appearance it was like a huntsman's horn, 18 ins. long and 6 ins. across at the top.—*Railway and Locomotive Engineering*.

RECLAIMING WEDGES WITH BROKEN FLANGES

BY WILLIAM HALL

International & Great Northern, Palestine, Texas

Some railroads use cast steel bronze-lined wedges, while others use solid bronze wedges. The cost of these is very high as compared with the cost of the gray iron driving box wedge which has been in common use for a great many years.

It is the flange of the gray iron wedge which is most frequently broken. Ordinarily these flange shoes must be scrapped and new ones machined to take their place. The

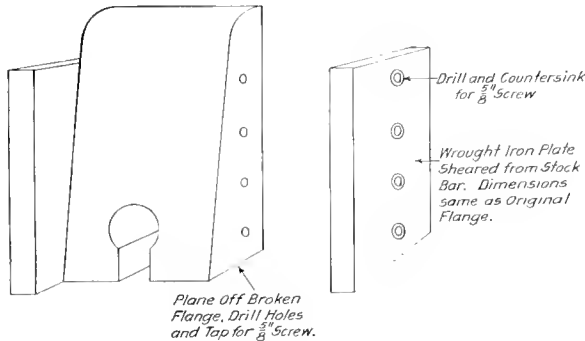

Cast Wedge Shoe Prepared for Iron Plate Flange

drawing shows a method of preparing these shoes, which is not only satisfactory, but lengthens the life indefinitely.

If the flange has been broken, as indicated, the shoe is planed off on the side to the depth of the original flange. Four holes are then drilled and tapped for $\frac{5}{8}$ -in. screws. The wrought iron plate is sheared from ordinary stock bar iron of dimensions suitable to the size of the original flange. This is then drilled and counter sunk to accommodate $\frac{5}{8}$ -in. screws, spacing being according to the spacing on the shoe.

Standard patterns can be changed to cast the wedge flangeless on the hub side so that when it is necessary to use a new one all that has to be done is to put on a wrought iron plate of the proper dimensions.

THE USE OF COMPRESSED AIR IN RAILROAD SHOPS*

Compressed air, which was used before electricity as a transmitter of power, is used in practically every railroad shop in the country, and besides being used it is also much abused at many of these points.

Compressed air has the possible advantage over electricity in that means of utilizing it can be cheaply and easily manufactured. It is largely owing to this fact that it has been developed for railroad shop and yard work. It has the same disadvantage, however, as using a cheap but inefficient motor; the first cost is low, but the consumption of power is high. This might not at first be thought a serious consideration, but a check of several shop power plants showed that, not deducting for the exhaust steam, the shop air compressor consumed over 30 per cent of all the steam generated by the shop power plant. This is due to several causes:

First: The use of compressed air has been developed for various classes of shops, so that each individual shop, roundhouse, and yard that makes up a group of railroad shops has its air lines and air tools.

Second: Unlike an electric transmission system a compressed air system can have a large number of leaks without

causing immediate trouble other than an increased load on the air compressor. Even with careful supervision over the pipe lines there are always leaky valves developing, valves carelessly left partially open, or leaky air hose left with the pressure on it, while the compressor runs on twenty-four hours in the day, compressing air to be wasted.

Third: As shop air lines are constantly being extended it is not at all unusual for the feeders to be outgrown. This is a frequent cause of complaint, the complaint usually being that the compressor is too small, whereas, in this case, the compressor is not to blame. In planning a compressed air system, it is most important to get the mains and the reservoirs large enough not only to take care of the present but to provide for future growth.

Fourth: As a usual thing, the smaller shops are dependent on one air compressor alone, which require that this compressor run twenty-four hours in the day and three hundred and sixty-five days in the year. The result is that the engineer postpones any heavy repairs on the air compressor as long as he possibly can with a corresponding increase in the coal bill for which the air compressor is often not suspected.

All in all, the air compressor and the compressed air equipment are very important and useful parts of a shop's equipment, but unless great care is taken they are much less efficient than they should be.

ELECTRIC DRIVEN COMPRESSORS

Where a steam plant is necessary regardless of whether a steam driven compressor is installed or not, especially when the greater part of the exhaust steam is needed for heating during a portion of the year, and further when a steam driven compressor can be installed in the power plant, and operated without the need of an additional engineer, an electric driven compressor cannot show much, if any, economy over the steam driven machine. The advantage of the electric driven compressor is that it can be located near the point where the air is to be used, consequently long pipe lines can be avoided. With the electric compressor, as well

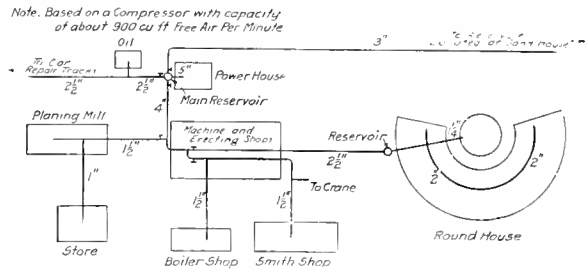

Diagram of Compressed Air Piping for a Roundhouse Plant

as with the steam driven compressor, a certain amount of power is consumed whenever the machine is running idle. A recent check of a motor driven, two stage compressor of about 500 cu. ft. per minute capacity showed that the electrical energy used, while the equipment was running unloaded, was 17 per cent of the amount used when compressing air to 110 lb. pressure. Of course, this loss may be avoided, especially with the smaller sized compressors, by installing an automatic starter for the motor controlled by a pressure regulator. The advisability of such an installation depends largely on whether there are fairly long periods when the compressor may be shut down if equipped in this manner. If the compressor is required to start every few minutes, it would be more advisable to install an unloading device on the compressor and permit it to run constantly at full speed. With a plant using one or more electric driven compressors, the question of whether the equipment shall be located at one point or distributed at two or more points depends on the first cost

*A report presented before the convention of the Association of Railway Electrical Engineers, held in Chicago, October 31 to November 3, 1916, inclusive.

of the installation, the cost of transmitting the air and the electricity to the desired points, the diversity of the load and the cost of attendance. As these items vary for each plant considered, it is impossible to lay down a definite rule. In the case of yards located at considerable distances from the steam power plant, it would be cheaper to transmit the electricity to the desired point than to transmit the compressed air with the same percentage of loss. On the other hand with a fairly compact shop plant, the additional cost of a pipe line designed to transmit the air efficiently from one point would be counterbalanced by the advantage of having all of the compressor equipment under one supervision.

DESIGN OF A COMPRESSED AIR SYSTEM

The diagram submitted shows an example of compressed air piping at a roundhouse point. It should be noticed that care has been taken to have several air reservoirs distributed throughout the plant to reduce friction loss and to keep the air as dry as possible, each reservoir acting as a settling tank for moisture. Care has also been taken to have the mains to the different buildings, or groups of buildings, separated as much as possible, and to have valves located in the different lines. By this arrangement, the air can be shut off from all shops not requiring air, as at night or on Sundays, and still leave the line to the roundhouse, etc., open. This has the added advantage of permitting repairs to be made on part of the system without the necessity of shutting down the compressor.

COST OF LEAKS IN AIR LINES

The importance of keeping all unused air lines shut off and of keeping all lines in first-class condition may be emphasized by taking a concrete example.

Assume that air compressed to 100 lb. pressure at a certain shop is costing 4 cents per thousand cu. ft. of free air. A hole 1 16 in. in diameter in the pipe line would permit a leak of 6.45 cu. ft. of air per minute, which would cost 37 cents per day of 24 hours, or \$135 per year. The following figures are the results of a test for air leakage, which was run at the shop and terminal plant of a railroad entering Chicago. At the time the test was run, there were no machines in operation, therefore, the total leakage was due to leaks in the air line. This line was originally installed about 25 years ago, but has been continually repaired and added to

cu. ft. As the system started to leak as soon as pressure was put into it, the time of leakage is calculated from the time the engine was started. The pressure during this time was variable, going from 0 lb. gage to 100 lb. and back to 40 lb., but as the flow of gas through an orifice is practically constant when the inside pressure is more than two times that of the receiving gas, it is safe to assume that the rate of leakage was constant.

A leakage of 15 per cent was assumed during the time the compressor was working. Subtracting this amount from 21,331.4 cu. ft. there was .85 x 21,331.4 or 18,131.69 cu. ft. of free air in the system when the compressor was stopped. As there was no way to determine whether or not the 15 per cent leakage assumed was correct, it was necessary to assume a per cent loss and after calculating check back and find how the assumed and calculated values checked.

ELECTRIC VERSUS PNEUMATIC PORTABLE TOOLS

Portable tools can be divided into two classes: rotating tools such as drills, motors, etc., and reciprocating tools such as riveting hammers, etc. For the reciprocating class the electric tool, in its present stage of development seems to have no advantages over the air tools. It can merely be said that for light work there are electric tools of this type on the market. For rotating tools the following statement gives a comparison of the advantages of the two types:

Lightness.—The pneumatic tool is considerably lighter and consequently easier to handle than the electric tool. The increased weight of the electric drill over the pneumatic varies roughly from 10 per cent in the larger sizes to 25 per cent in the smaller. However, the electric tool has the advantage that a portable electric cord is much easier to handle than an air hose. It has also sometimes developed that two men with an electric drill will accomplish more than twice as much work as one man with a pneumatic drill.

Efficiency.—This is the chief advantage that the electric tool has over the pneumatic. This is due first to the tool itself, and, especially as the work varies from second to second, a portable pneumatic tool speeds up the instant the load is removed, thus taking more and more power as the load is released, whereas with the electric tool the exact reverse is true. On full load the efficiency of the electric drill varies from 30 per cent in the smaller sizes to as much as 80 per cent in the larger sizes, whereas the efficiency of the pneumatic tool varies from about 18 per cent to 35 per cent, depending on the size. The total system of generation and transmission is usually more efficient in the case of electricity than in the case of air. The instant current is turned off of the electric tool the supply of energy ceases, there are no valves, air hose, couplings and pipes to leak.

First Cost.—The first cost of a pneumatic tool is less than that of an electric tool.

Trouble from Freezing.—Electric tools are free from the annoyance that the air tools often give of freezing up in the winter time.

Cost of Maintenance.—Accurate figures have not been obtained by the committee as to relative cost of maintenance of the two types of tools. Electric tools will not stand the abuse that pneumatic tools will, but where not abused it is probable that the maintenance of electric tools is considerably less than that of pneumatic.

REASONS FOR ANNEALING STEEL.—Annealing steel has for its object: (a) completely undoing the effect of hardening, leaving the steel in its softest and most ductile condition; (b) removing any strains set up by rapid cooling, particularly if the rate is different in different parts of the piece; (c) refining the grain. For (a) and (b) it is sufficient to heat below the critical point, say to 1,110 deg. F., but for (c) the temperature must be raised above the critical point. —*Bulletin, U. S. Bureau of Mines.*

DATA

Total air in system at 100-lb. gage.....	18,131.69 cu. ft. free air.
$(V1 - V2) = \frac{P1 - P2}{P1}$	
Now $V = \frac{(V1) P1}{P2}$	
V1 = original volume of free air at.....	100-lb. gage = 18,131.69
V2 = volume free air at.....	40-lb. gage = ?
P1 = absolute pressure at.....	100-lb. gage = 115 lb.
P2 = absolute pressure at.....	40-lb. gage = 55 lb.
Let $V = \frac{V1 - V2}{P1 - P2}$ = volume of free air leaked.	
Now $V = \frac{V1 (P1 - P2)}{P1}$ =	$\frac{18,131.69 (115 - 55)}{115}$ = 9,446 cu. ft. of
	free air in 55 minutes, or 171 cu. ft. per minute.
Steam used per cu. ft. of free air =	.1306 lb.
Steam used in pumping leaking air, per minute.	.1306 x 171.7 = 224 lb. = 1,344 lb. per hour.
$\frac{1,344}{30}$ =	44.8 boiler hp. hrs., at \$.005 per boiler hp. hour.
	Cost per hour of leaks = \$0.224
	Cost per day (24 hr.) = 5.38
	Cost per month = 161.40
	Cost per year = 1,936.80
Add 50% for machine leaks when shop is in full operation =	\$2,905.20.
Cost of producing 1,000 cu. ft. of air equals	$\frac{.1306 \times 1000}{.005} = \$2,012.5$

Note that the air compressor was not as efficient as it should be.

since then. The figure for steam consumption per cu. ft. of air was obtained in a previous test.

After the system was filled to a gage pressure of 100 lbs. per square inch, the compressor was stopped. When the gage pressure had reached 40 lb., the time was noted. The amount of free air pumped into the system was 21,331.4

THE ELECTRIC WELDING PROCESS*

Description of Methods and Equipment; Organization and Standardization of Work Emphasized

AN electric arc is formed when a current of electricity passes from one conductor to another conductor through an incandescent vapor. The conductor from which the current passes into the incandescent vapor is called the positive electrode or anode, the conductor to which the current passes from the incandescent vapor is called the negative electrode or cathode. It is estimated that approximately 75 per cent of the resistance offered to the passage of the current of electricity from anode to cathode occurs at the anode. The remaining 25 per cent of the resistance is in the vapor and in the cathode. It is generally believed that more resistance is offered by the cathode than in the vapor of the arc in short arcs such as are used in the arc welding process. Since the amount of heat in any part of the arc or electrodes is proportioned to the amount of resistance offered by that part of the arc to the passage of the electric current, it is evident that the visible arc or flame liberates a comparatively small percentage of the total heat of the arc. The largest part of the heat is liberated at the positive electrode.

POLARITY FOR WELDING

Owing to the fact that the heat of the arc is produced in greater quantity at the positive electrode, in electric arc welding practice it is necessary to consider the matter of polarity.

In metal electrode welding, the mass of the welding wire which is being melted is usually less than the mass of the piece to which the metal is being added so that the amount of heat lost by conduction is greatest on the piece to which the metal is being added. For this reason the piece of greater mass is made the positive electrode. In certain cases, such as the welding of very thin sheet metal, the wire being melted is made the positive electrode in order to reduce the tendency of the arc to burn through the sheet metal.

When the slag coated electrode is used, the wire is usually made the positive electrode. In this case, the arc operates under a slag so that a considerable percentage of the heat otherwise radiated is retained in the vicinity of the arc. This conservation of the heat on the heavier piece permits the higher rate of melting of the metal being added.

It is necessary to use the carbon electrode as the cathode in carbon electrode welding. The current of electricity must pass from the metal to the carbon, otherwise the carbon will be carried into the metal being welded, causing hardness.

HEAT DEVELOPED IN THE ELECTRIC ARC

The electric arc transforms electrical energy into heat. The heat is intense because a comparatively large amount of energy is transformed into heat in a small area. One kilowatt hour of electrical energy is equivalent to 3,413 B.t.u. Thus an arc in which the current is 150 amperes and the voltage between electrodes is 20 volts will transform three kilowatts of electrical energy into 10,239 B.t.u. in one hour of continuous operation. Similarly, one cubic foot of acetylene gas burned in oxygen will produce 1,555 B.t.u. of heat. Thus the three kilowatt hours of electrical energy will produce the same amount of heat as may be produced by approximately 6.6 cu. ft. of acetylene burned in 7.5 cu. ft. of oxygen.

The amount of heat which can be used in the arc welding process depends largely on the size of the wire electrode being used. The kind of wire being used and the character of the piece being welded also affect this factor. The fol-

lowing table shows the limits indicated by present practice:

Kind of electrode	Size	Current	Voltage	Work
Mild steel electrode	1/8 in.	60-90	14-16	2 in. flues
Mild steel electrode	5/32 in.	110-140	16-20	5-in. flues; filling
Mild steel electrode	3/16 in.	150-180	18-25	Filling
Carbon electrode	3/4 in.	250-350	35-50	Cutting; welding
Carbon electrode	1 in.	350-500	35-50	Cutting; welding

ELEMENTARY METALLURGY

The electric arc welding process (metal electrode) reduced to its simplest terms, is simply a means of melting steel wire and allowing it to flow while molten onto another piece of steel which has been melted over a local area. There are three important changes which occur in the metal during the process:

1. The effect of mechanical treatment is entirely eliminated over the area heated to a plastic or molten state. The metal thus affected becomes cast steel.

2. Unless the molten metal is protected by a slag covering, it is oxidized to a certain extent by the oxygen present in the atmosphere, tending to make the metal cold short.

3. A large percentage of the impurities (carbon, manganese, nickel, vanadium, chromium, etc.), which may be present in the steel before welding, is vaporized or oxidized and has disappeared after the operation.

The net result is that in bare wire welding, the metal obtained in the weld may be as high in tensile strength as the metal in the original piece being welded. It will be rather low in ductility, but will be soft if the metal before the operation was not over .35 per cent in carbon content. No method has been demonstrated up to the present time of giving the cast steel in the weld the same characteristics to the same degree as those found in flange steel.

In spite of the comparatively low degree of ductility of the metal obtained in the weld, the process is entirely practical as a means of welding both cast steel and boiler plate owing to the fact that the welded area may be reinforced where great resistance to fracture must be produced.

APPLICATION IN RAILROAD SHOPS

The simplest application of electric arc welding in the railroad shop is the "building up" operation. Practically every steel casting on the locomotive is subject to wear at several points. Wearing surfaces are rapidly worn down and bolt holes wear large.

The metal electrode process should be used for these building up operations for the following reasons:

1. Locomotive steel castings welded with the carbon arc should be annealed before being put in service. The locomotive shop is not equipped to anneal castings.

2. Metal may be more accurately placed with the metal electrode process than with the carbon electrode process. Time saved in the welding operation using the carbon arc is more than lost in the machining operations.

3. Less skill is required to operate the metal arc than the carbon arc for building up operations.

4. There is no possibility of hard spots when the metal electrode process is used for the operation.

Most of the building up operations should be done with a 3/16-in. electrode. The use of smaller electrodes is not economical owing to the slow speed. The use of the larger bare wire electrode is not good practice owing to lack of control of the metal.

WELDING BOILER PLATE

Welding in the firebox should be done with 1/4-in. or 5/32-in. electrodes. The best metal is obtained in the weld

*From a report presented at the convention of the Association of Railway Electrical Engineers held in Chicago, October 31 to November 3, 1916.

with these sizes. The amount of heat is as small as can be economically used. It is evident that owing to expansion and contraction difficulties, the quantity of heat it is possible to use in welding flues or firebox sheets is limited.

The ideal preparation of a set of flues for welding is as follows:

1. Put flues in exactly as if they were not to be welded.
2. Fire the boiler, or, better still, send the engine out for a run. The object is to burn the oil out from under the beads of the flues.
3. The flue sheet should then be brushed with a stiff

edges of the crack should then be beveled so that the operator can get at them to make the weld. On horizontal cracks, the lower edge does not need to be beveled but should be chipped to give a square edge. The upper edge should be beveled at least 45 deg. Vertical cracks should be beveled from 30 deg. to 45 deg. on each side. The less material removed from the crack the better. All welds should be made with the least possible amount of metal between the edges of the original material.

If the crack or seam is a long one, the metal should be put in alternate sections 4 in. to 6 in. long. The operator

TABLE I.—STATEMENT OF WORK PERFORMED WITH ELECTRIC WELDER AT LOCOMOTIVE SHOPS

1916	No. of engines	No. of flues welded	Actual time welding, hr. and min.	Labor	Material	Current	Total cost, actual	Time preparing for welding, hr. and min.	Cost preparing for welding	Total cost to engines	Average cost per engine
Total for 2-in. flues	247	42,640	2,811' 15"	\$990.77	\$181.09	\$843.72	\$2,015.58	232' 45"	\$80.39	\$2,093.97	\$8.48
Total for 5-in. flues	196	5,034	1,473' 45"	\$20.01	85.47	442.16	1,047.64	24' 00"	10.08	1,056.12	5.39
Total for smoke consumer tubes	244	1,946	122' 00"	42.85	9.76	36.60	89.21			89.21	.37

MISCELLANEOUS JOBS

1916	No. of operations	Labor	Material	Current	Total cost	Other method	Saving	Saving per operation
January	461	\$183.07	\$47.88	\$155.70	\$386.65	\$1,176.58	\$789.93	\$1.71
February	433	218.08	59.89	187.70	465.67	1,558.56	1,092.89	2.52
March	584	253.37	64.57	199.13	517.07	1,871.44	1,354.37	2.32
April	325	172.92	42.62	134.30	349.74	1,232.65	882.91	2.72
May	487	228.22	60.62	175.52	464.36	1,839.54	1,375.18	2.82
June	579	210.09	54.94	175.52	440.53	1,726.10	1,285.55	2.22
July	523	165.97	41.12	135.62	342.71	1,501.33	1,158.62	2.22
Totals	3,392	\$1,431.72	\$371.64	\$1,163.39	\$2,966.75	\$10,906.20	\$7,939.45	\$2.34

wire brush or sand blasted. The object is to eliminate, so far as possible, the scale of oxide on the flue sheet and flues. Iron oxide is not a good conductor of electricity and causes difficulties with the arc which in turn may produce a poor weld.

The welding of 2-in. tubes is done best with 1/8-in. electrode. On sand blasted flue sheets 90 to 100 amperes is enough current. Flue sheets that have a thick coat of oxide

should put one layer of metal in each of these alternate sections starting near the center of the seam or crack. The open sections can then be filled starting at the coolest point. Successive layers of metal can then be applied until the seam is completed. Wherever possible, at least 30 per cent of reinforcing should be applied so that the cross-section through the weld is 30 per cent greater than the section of the original plate. After each layer of metal is welded

TABLE II.—MISCELLANEOUS ELECTRIC WELDING—LOCOMOTIVE SHOP—ONE MONTH

Description	No. of operations	Labor	Material	Current	Total cost	Other method	Saving
Bumper Beam	1	\$1.41	\$0.33	\$1.35	\$3.09	\$5.00	\$1.91
Brake Shoe Heads	102	11.79	2.48	9.55	23.82	80.58	56.76
Brake Hanger Bracket	1	.33	.02	.08	.43	1.25	.82
Crossheads—Piston	17	12.96	3.29	10.53	26.78	133.06	106.28
Crossheads—Valve	22	3.39	.55	1.95	4.89	13.93	9.09
Crosshead Pins	3	.83	.18	.53	1.54	4.47	2.93
Deck Castings	7	10.12	6.90	20.70	57.83	484.32	426.49
Driving Boxes	4	2.10	4.20	1.80	8.10	105.48	97.38
Driving Box Lugs	10	1.08	.33	.88	2.29	6.90	4.61
Frames	2	5.11	1.25	4.20	10.56	57.84	47.28
Frame Cross Brace	1	2.59	.60	1.80	4.99	21.75	16.76
Eccentric Blades	5	.96	.21	.86	2.03	5.44	3.41
Eccentric Crank	1	.19	.05	.15	.39	12.74	12.35
Guide Bars	69	99.52	28.91	86.33	214.76	423.03	208.27
Guide Yoke	1	.66	.10	.30	1.06	9.74	8.68
Levers—Combination	17	2.66	.60	1.73	4.99	32.37	27.38
Links	33	3.44	.89	2.35	6.68	36.41	29.73
Link Hangers	12	1.36	.30	.90	2.56	3.24	.68
Link Saddles	2	.59	.10	.45	1.14	8.32	7.18
Miscellaneous	6	1.48	.10	.50	2.17	4.86	2.69
Quadrants—Teeth	3	2.48	.05	.23	5.56	2.43	1.87
Rods—Main	9	20.61	2.70	10.03	33.34	89.04	55.70
Rods—Side—Grease Pin Holes	106	.65	.23	.68	1.56	12.29	10.73
Rod Straps	7	4.16	1.10	3.30	8.56	53.78	45.22
Reverse Lever Heels	3	.57	.15	.45	1.17	7.80	6.63
Reverse Lever Latches	6	.66	.13	.53	1.32	11.55	10.23
Spring Saddles	8	2.19	.60	1.80	4.59	22.99	18.40
Spokes—Driving Wheel	9	6.01	1.59	4.20	11.71	42.50	30.79
Shop Tools and Machinery	1	.72	.13	.50	1.35	6.00	4.65
Tail Sheet	1	.33	.05	.15	.53	1.50	.97
Tumbling Shaft	2	3.13	.85	1.00	4.98	49.21	44.23
Tender Truck Equalizers	8	4.18	.80	3.15	8.13	78.30	70.17
Transmission Hangers	6	.57	.10	.38	1.05	1.38	.33
Total	487	\$228.22	\$60.62	\$175.52	\$464.36	\$1,839.54	\$1,375.18
Net saving for month						\$1,375.18	

require from 120 to 130 amperes on this size wire. The 5-in. flues should be welded with 5/32-in. electrode with 120 to 140 amperes, depending upon the condition of the flue sheet.

Cracks and patch seams offer the most difficult problems to the operator. A crack should be located and at least two inches beyond each end a 1/2-in. hole drilled. The

into the seam, it should be thoroughly brushed with a stiff wire brush to remove as much of the oxide as possible. Where the sand blast is available and can be used on the job the results will justify the expenditure of time necessary to clean the metal between layers. The same general care should be taken in the welding of locomotive frames as in the case of the boiler plate of the firebox.

Aside from the use of judgment in the application of the electric arc welding process, there are three rules which the operator must observe to get the best results in welding: Hold a short arc; use a low current; and always work on clean metal.

COST DATA

The cost data presented in the accompanying tables were obtained in one of the largest locomotive shops of the country. The period covered by Table I was seven months, and that covered by Table II was one month; the cost of electric power was 2 cents per kw. h.

ELECTRIC ARC WELDING EQUIPMENT

The power required for electric arc welding at the electrodes is low voltage direct current. The metal arc requires from 75 to 180 amperes at 15 to 30 volts. The carbon arc requires from 250 to 400 amperes at 40 to 50 volts. The only object in using welding equipment is to get power of this nature economically. So far as welding is concerned, quite as good work can be done with resistance ballast across 250 volts direct current, as is possible with the most refined and highly developed equipment.

There are two types of equipment on the market which may be described as constant voltage type and variable voltage type. The constant voltage type is a motor generator set which takes power from the shop mains and delivers on the generator end a practically constant low voltage. The low voltage direct current power is carried over the shop on heavy cable to the welding outlets. The variable voltage type is a motor generator set which takes power from the shop mains and delivers on the generator end the voltage required for welding without the use of resistance ballast. With this type of equipment the low voltage distribution system may be eliminated.

The desirability of any installation of welding equipment is based on the following points: Reliability and flexibility; operation cost; cost of the installation complete, including wiring, apparatus and installing.

At the present time it appears that 150 amperes capacity for each 5 tracks in a locomotive shop or for each 15 tracks in an engine house is sufficient capacity.

An operator's shield for building up operations which is very satisfactory can be made of a soft pine board with a small slot in it for the protective glass. Firebox work requires a head shield which should be made of hard fibre. The color combination in the protective glass is of importance. Two red glasses and one blue glass or two reds and a green give good results. Special glass put out under various trade names is also satisfactory. While the operator is working outside the fire box, the other men should be protected from the light of the arc by screens. Portable screens should be used where work is done on the floor. Where a regular welding bench is provided, permanent curtains should be provided. The screens should always be designed to protect the crane operators from the flash of the arc.

SHOP ORGANIZATION

The importance of the welding operations in a locomotive shop or engine house is so great that it is necessary for the work to be done under the direction of a competent and responsible member of the railroad organization. On a large system where welding is done at several shops and engine houses it has been found that unless some special effort is made in that direction the practice of one shop has not usually conformed with the practice of the other shops of the system. This leads to a situation in which it is impossible to place the responsibility for the success or failure of the process. A very successful solution to this problem has been made on several systems by the appointment of a supervisor of electric welding who is responsible directly to the general superintendent of motive power. The supervisor of electric welding

makes the practice of the several shops uniform so that the failure of one shop to get results from a process can be traced to its origin. The supervisor of electric welding must find a successful way of doing each job and require every shop to perform the operation according to his instructions.

When failures of certain operations are reported the supervisor of electric welding can readily locate the trouble since it can only be due to the failure of some particular shop to follow his instructions. In this plan the operators in each shop are responsible to the local shop authorities in the usual way and are responsible only to the supervisor of electric welding for the manner in which they perform the welding operations. The operators in a given shop are usually in charge of a foreman operator, who assigns them to individual jobs and is responsible for their following instructions of the welding supervisor.

Operators are obtained in most cases from a shop organization. On roads where an apprenticeship training is provided most of the operators are men who have just completed the apprentice work. It is desirable to have operators who have had general experience in a railroad shop. In shops which have a local electrician the care of the electric arc welding equipment is handled by the chief electrician. In engine houses the operator of the equipment is usually trained to give the equipment whatever care is necessary.

STANDARDIZATION OF OPERATIONS

The tendency at the present time is to standardize the welding operations in the same manner that the machine shop and other operations have been standardized. Where welding operations are thoroughly standardized the work can be paid for on a piece work basis. The standardization of welding operations is comparatively simple on systems which employ a supervisor of electric welding. On other roads it is more difficult to standardize the operations, but the necessity for having them standardized is greater. Ninety-five per cent of the electric arc welding done in railroad shops is on operations which can be standardized. The following factors should be determined for each job of this nature: Size of electrode; kind of electrode; current in the arc, and time required for the operation.

LATHE CENTERS AND DRILL PRESS AND MILLING-MACHINE SOCKETS*

BY CARL G. BARTH

It is well known that the Morse sockets are no standards at all, but a perpetuated, unsuccessful attempt of years ago to establish standards. Compelled for the time being to accept them as they are, everybody has now at least two standard tapers for sockets and shanks to contend with, namely the Morse, and the Brown and Sharpe. The best the writer has been able to do has been to make all lathe centers conform to a Morse standard, enabling drills or drill sockets to be directly inserted in the spindle of some or all lathes in a shop; and to make all milling-machine sockets conform to the Brown and Sharpe standard, with Morse drill sockets having Brown and Sharpe shanks for use with these whenever drilling has to be done on a milling machine.

The writer unqualifiedly recommends the universal adoption of the Brown and Sharpe standards all around, and the use of Morse sockets with Brown and Sharpe shanks during the change. He also recommends the universal abandonment of the tang as a means of driving. We have for years had the ridiculous inconsistency of drill makers, that they still furnish taper-shank drills with the old-style tang as a means of driving, and along with this extensively advertise and sell various forms of "use-them-up" sockets for drills with the original tang broken off. More than twelve years

*From a paper on Standardization of Machine Tools, presented before the annual meeting of the A. S. M. E. in New York City, December, 1916.

ago the writer adopted a modification of William Sellers & Company's key method of driving as a substitute for the tang of drills, arbor and boring-bar shanks. This is illustrated in the drawing, and differs from the Sellers method in the use of a special form of key that has become known as the Barth key. The virtue of this as a means of driving

by $\frac{1}{2}$ -in. bar frame through an angle at each end, and to it is riveted the axle. A 5-in. by $9\frac{1}{2}$ -in. block tapered on each end, on which the mounted wheels ride is secured to the bed plate. The wheels of the truck are 12 in. in diameter and are held on the axle by the bar frame. The block of wood which supports the wheels is reinforced, as shown in section *AB*, and has an overhang, as shown in the end view. The lowest part

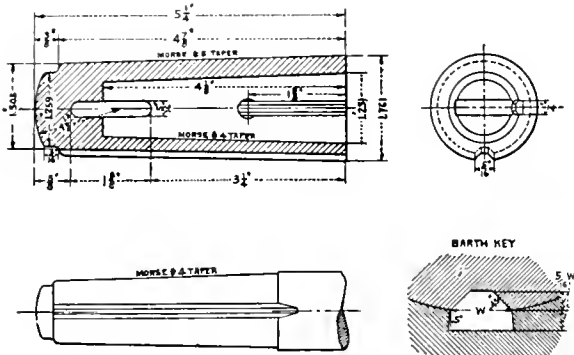

Key Method of Driving Drill, Arbor and Boring-Bar Shanks

consists in its being subjected to crushing pressures only, and that it has no tendency to work out of its seat. For a taper drill socket it has the additional great advantage over the Sellers straight key that the drill shank can be inserted rapidly without any special care.

MOUNTED WHEEL TRUCK

For convenience in transferring mounted wheel trucks from one part of the plant to another, George W. Bill, general foreman of the Union Tank Line Company, Whiting,

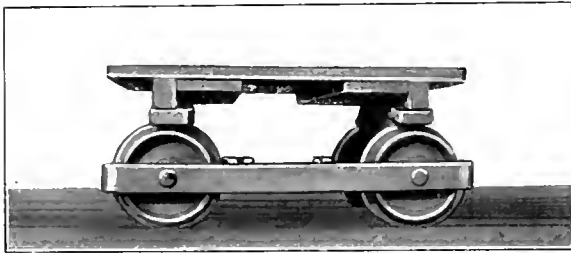

Platform Applied to the Wheel Truck

Ind., has devised the truck shown in the accompanying illustration. It consists of a bed plate of $\frac{1}{2}$ -in. steel $19\frac{1}{2}$ in. wide by 3 ft. 10 in. long which is secured to a $3\frac{1}{2}$ -in.

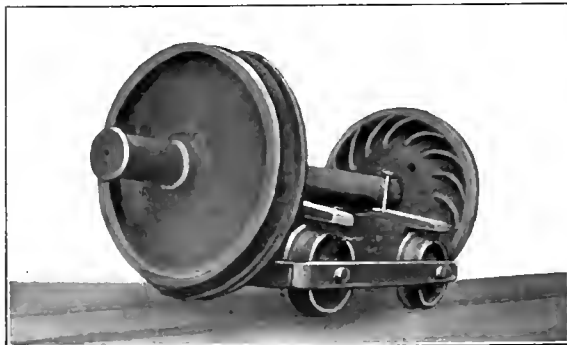

Truck with Mounted Wheels in Place

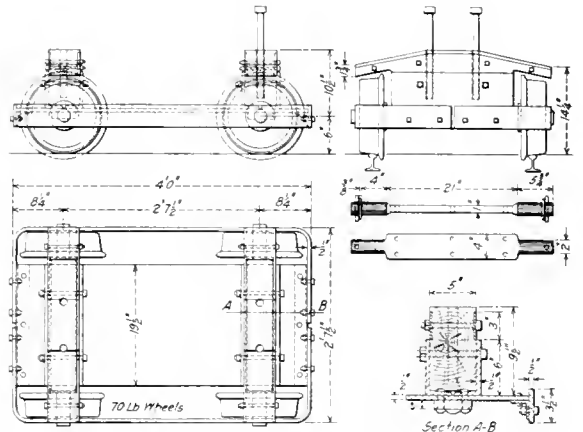

Details of Truck for Moving Mounted Wheels

of this tapered overhang is slightly lower than the height of the bottom part of the axle of the mounted wheels, so that they may easily be rolled up the inclined plane and held on top of the truck by two bolts, as indicated in the drawing. One of the illustrations shows a platform which may be mounted on the truck, permitting its use for carrying other articles about the shops.

SAVING METAL IN VALVE BUSHINGS

BY W. J. BOHANNON

Since the general adoption of superheated steam it has become necessary to use a higher grade of iron than was formerly used for valve bushings, owing to the much higher temperatures found in valves and cylinders. As this metal, being of special content, is bought in the outside market and is not cast in the railroad companies' foundries, the cost of bushing has increased considerably.

It has been the common practice to buy these bushings of special material the same length as the old ones. It has been noted, however, that these bushings are much longer than is actually needed and by reducing the length considerable saving can be effected.

To determine the shortest length of bushing that can be used, all that is necessary is to force the valve up against the front and back valve chamber heads in turn, marking on the inside of the opposite bushings the position of the edges of the valve head. The lines thus secured on each of the two bushings will measure the lengths that are necessary to carry the valve and the distance from the line to the end of the bushing represents the amount of metal that can be dispensed with.

AUTOGENOUS WELDS FOR STEAM BOILERS.—The Swiss Society of Steam Boiler Owners has recently reported on an exhaustive investigation into autogenous welds for steam boilers, and the report confirms the opinion of engineers generally that, everything considered, such welds should not be used where high pressures are employed and where riveting is not unreasonably difficult.—*Power*.

New Devices

CAR VENTILATING SHUTTER

A shutter for ventilating box and fruit cars and at the same time keeping them weather tight and burglar proof is shown in the accompanying photograph. It is made of malleable iron and it is claimed to be indestructible and so arranged that the shutter can not be lost out.

This shutter, which is manufactured by the Wine Railway Appliance Company, Toledo, Ohio, is made in two types, one for ventilating purposes only, the other to permit a larger opening for loading cars with lumber and other long material. The two types are interchangeable and are both made of standard parts.

Two side pieces and five cross pieces make up the frame, and they are securely riveted together to form a rigid construction. Brackets are cast integral with the side pieces to form supports for carrying the shutters. The lugs cast on each of the shutters form hinge joints, carrying the weight and permitting rotation. The shutters are so designed that



Shutter In Closed Position

when closed they completely fill the opening between the cross pieces. Their shape is such that when they are open they obstruct a direct passage through the ventilator, thus preventing the entrance of rain, sleet or snow.

The shutters are connected together and operated by a shutter bar which is attached to each individual shutter with cotter pins. The frame acts as a stop to this bar, thus limiting the up and down travel. When the shutters are either fully open or closed, the center of gravity is beyond the center of the hinge lugs, so that the weight of the shutters prevents them from changing their position. While permitting ample space for proper ventilation the distance between the lattices is small enough to make it impossible for anyone to creep through and enter the car. The overall dimensions of

the standard ventilator are 24 in. by 30 in. and the total weight is 120 lb., but any other size desired can be furnished.

A ROD AND DRAWBAR UPSETTING MACHINE

An upsetting machine is shown in the illustration which will shorten, lengthen, and straighten side rods, draw-bars, eccentric rods, link hangers, etc. The machine is of simple construction; the body being cast in one piece and provided with a groove for a sliding block which engages with the ram and is connected with toggle links. Underneath the center of the links is placed a 40-ton jack. The body is arranged to receive two cam shaped gripping blocks, also a movable block containing another pair of cam shaped gripping blocks.

When it is desired to shorten or upset a side rod or any forging, one end is held by either of the cams and the ram operates against the other. The heated part being between the cams and the end, the upsetting or shortening is easily accomplished. When a side rod or forging is to be lengthened, one end is held by one pair of gripping blocks and the other end by the other pair of cams in the movable block;

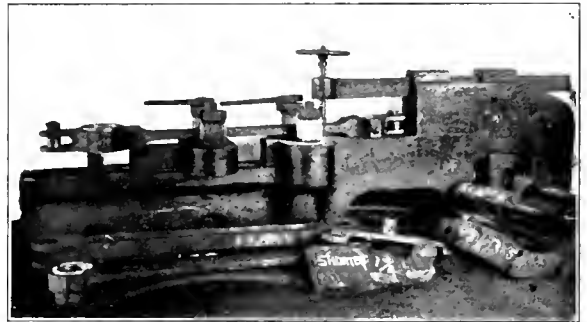

Machine for Shortening or Lengthening Rods

the ram acting against a bar in the body of the machine pushes the movable block and stretches or lengthens the rod or forging to the required length. Heat treated forgings may be adjusted without heating above the critical temperature. Pedestal binders are adjusted so accurately that they require no machining or filing. One blacksmith and one helper are required to operate the machine. This machine has been patented by Walter Stock, Albany, N. Y.

A CAR-WHEEL LATHE

An improved car-wheel lathe of extra heavy design has recently been brought out by the Niles-Bement-Pond Company, New York. It is of the open-center or end-driven type and is designed for the heaviest duty using modern high speed steel.

This machine is considerably heavier than any of the type previously built. The result is a machine much stiffer throughout, which makes possible a greater output. The weight has been so placed as practically to eliminate vibra-

tion under the heavy cuts of which the new high speed steel tools are capable. It will accommodate axle journals as large as 8-in. in diameter, and can therefore be used for

The right hand headstock is equipped with power traverse of a new design. The traverse is operated by a separate 8-hp. motor located at the end of the bed, which is engaged

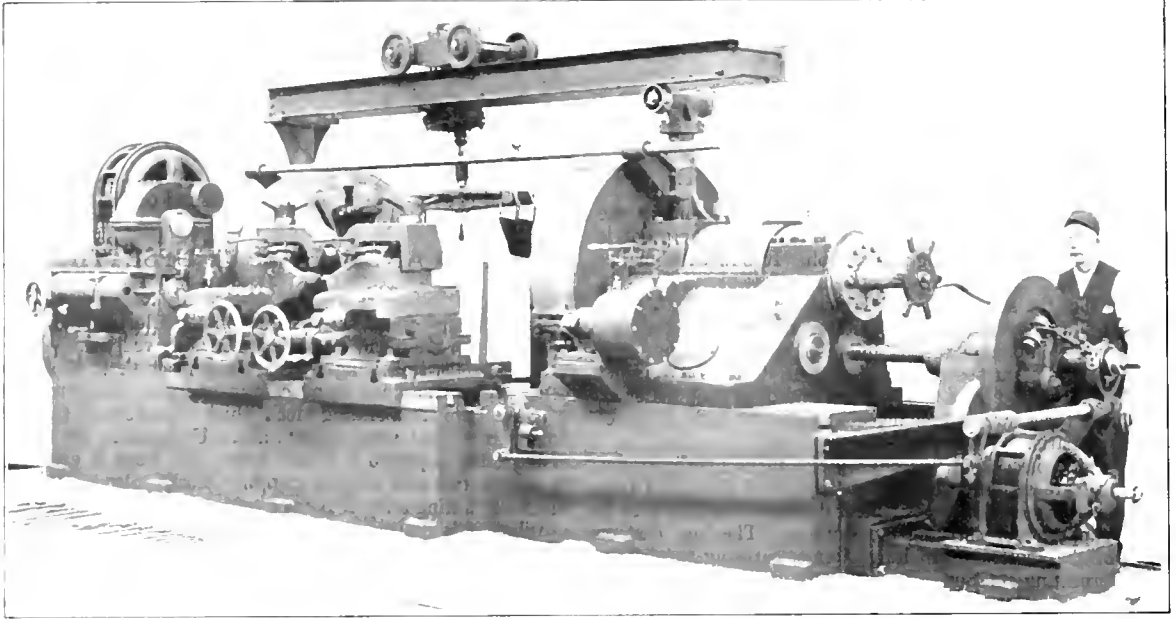

View of Car Wheel Lathe Showing the Power Traverse End

turning locomotive trailer wheels. The largest wheel diameter that the lathe will take is 44 in. on the tread.

One of the new features is a quick operating power device which enables the operator instantly to clamp the right-hand

by a large friction clutch operated by a lever conveniently located so that the operator may traverse the headstock without leaving his position near the wheels. The friction clutch is so adjusted as to slip when excessive power is applied, thus

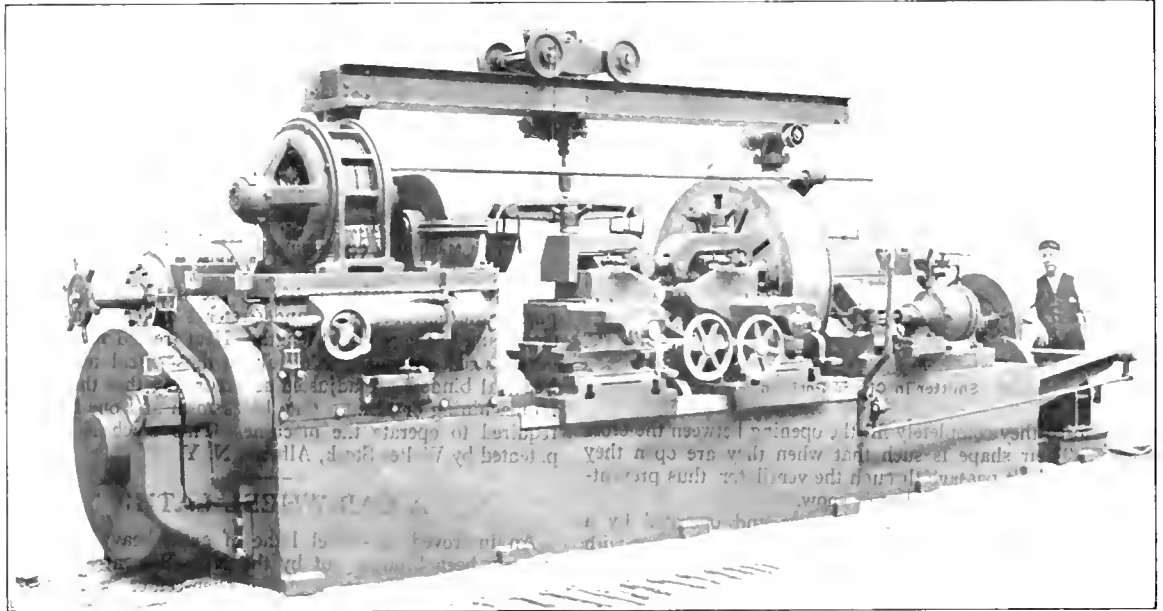

View of the Wheel Lathe Showing the Driving End

head-stock by simply turning an air valve. The device is operated by a large air cylinder and clamps the head to the bed at both the front and back simultaneously.

eliminating any possibility of damage to the mechanism in case the face plate is brought up too forcibly against the wheels.

When traversing the movable headstock to the right away from the wheels, the motion is disengaged by an automatic stop. Therefore the operator does not have to give further attention to this motion after engaging the clutch and damage to the mechanism from overtravel in this direction is avoided.

There is no exposed gearing. The left-hand headstock is of the enclosed type and contains the speed change gearing. The machine illustrated is equipped with alternating current drive. There are provided six speeds which are changed by means of the handwheel and lever shown on the front of the headstock. The machine is also furnished for D. C. motor drive by a three to one variable speed motor. In this case a push button control is furnished consisting of two pendant switches, one for starting and stopping and the other for slowing down the speed.

The faceplates are driven through internal gearing. Pinions are located at the front of the machine about 45 deg. from a vertical line through the center of the spindles, bringing the drive on the faceplates very close to the point of cutting.

The lathe is equipped with a simple calipering device by which the operator can readily size both wheels to the same diameter. It consists of an adjustable pointer on a bar which is rigidly supported on the headstocks and has a sliding bearing on the right-hand bracket.

The tool rests are equipped, as on previous models, with patented pneumatic tool clamps. The clamps enable the operator to change and clamp the tools in a few seconds without the use of a wrench. There is absolutely no chance of slipping or vibration of the tools under the heaviest cuts. The wedge action forms a positive lock independent of the air pressure.

THE WILSON ARC WELDER

Analysis of a number of defective electric welds has shown that they bore evidence of damage from excessive heat. As electric welding, from an economical standpoint, has proved itself of great importance, one trunk line railroad determined to find a method of making electric welds which would be free from failure, that is, free from damage due to overheating.

Expert operators were securing good results on some classes

machine was assigned to the railroad's chief electrical engineer and after a series of experiments a machine was produced which could be set to operate at a certain current value and would automatically keep within six per cent of that value as long as the arc was maintained. This equipment is now being placed on the market by the Wilson Welder & Metals Company, New York.

The Wilson electric welder consists essentially of a motor generator set, an automatic control panel, and a welding tool with a remote control switch attached. The generator

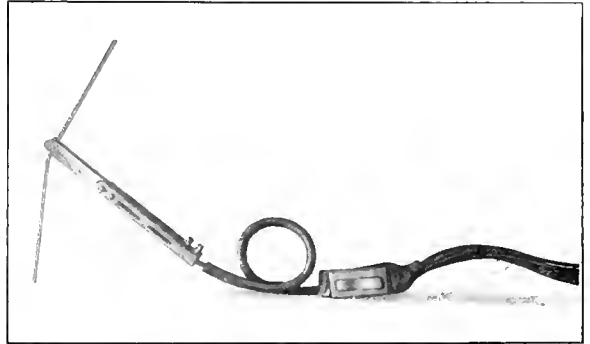

Welding Tool or Electrode Holder with Distant Control Switch

is of the constant potential type, with interpoles and laminated field structure. The control panel performs a general function of maintaining a constant current in the welding circuit, regardless of variations in the resistance of the welding circuit. This is accomplished by the carbon pile rheostat (No. 5 in the illustration of the panel) the resistance of which is varied by a lever mechanism operated by the electro-magnetic coil 29. Both rheostat and coil are connected in series with the welding circuit, consequently the action of the coil on the lever is governed by the amount of current in the circuit; a decrease of current allows the magnet plunger to drop, compressing the carbon pile, thereby

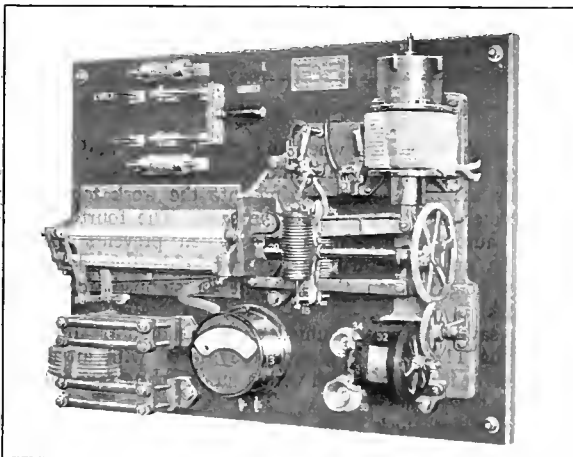

Control Panel. The Current in Each Arc Circuit Is Controlled with One of These Panels

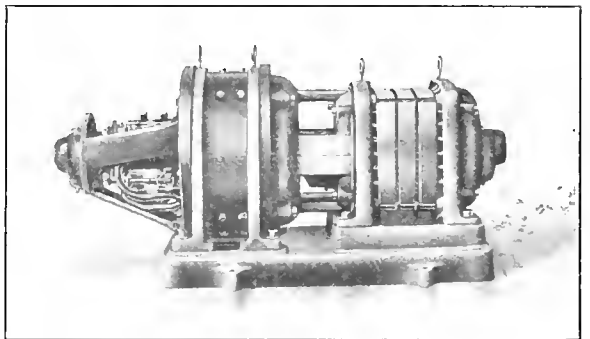

Four-Arc, 600-Ampere Capacity, Motor-Generator Set for Alternating Current

of work, on others it was the exception rather than the rule. After investigation the trouble was diagnosed as being due to the lack of heat control when using the ordinary type of welding outfit. The problem of designing a satisfactory

decreasing the resistance of the circuit which brings the current back to normal value. The actual value of the current is dependent on the leverage of arm 17, and to change the current the leverage of this arm must be changed. This is accomplished by moving the mechanism attached to the rheostat to a different point on the lever arm. The adjustment is made by the motor operated lead screw 20 which is a distinguishing feature of this panel. The motor is operated by the remote control switch attached to the handle of the welding tool. There are two contacts on this switch, one for raising the current and one for decreasing the current;

limit switches are provided on the panel to prevent the motor overrunning its limit of travel in either direction.

Motor generator sets of various sizes can be furnished. The smallest machine will handle one arc and is rated at 150 amperes. The largest machine, rated at 1,200 amperes, will handle eight arcs at the same time. The arcs are operated in multiple, but a separate control panel must be used for each. The use of a separate control panel makes each operator entirely independent of the other. A portable machine for field use is mounted on a gasoline motor truck while the shop type is mounted on a hand truck.

AIR STRAINER FOR LOCOMOTIVE AIR PUMPS

The Gustin-Bacon Manufacturing Company, Kansas City, Mo., has recently placed on the market an air strainer for locomotive air compressors which is made of malleable iron with either 1½-in. or 2-in. fittings, and weighs 8½ lbs.

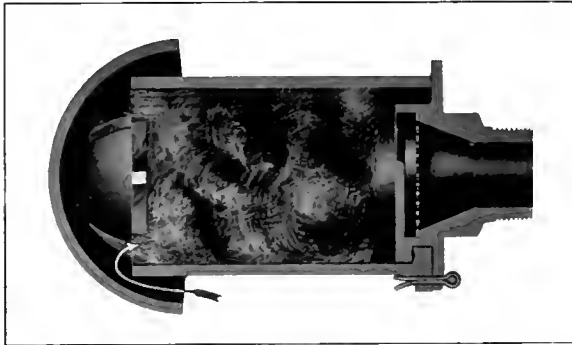

Section of the Locomotive Air Pump Strainer

This strainer may be applied to the intake of the air compressor in either the horizontal or vertical position. It consists of a 6-in. by 4-in. cylinder, filled with oil-soaked curled hair, through which the air must pass before it reaches

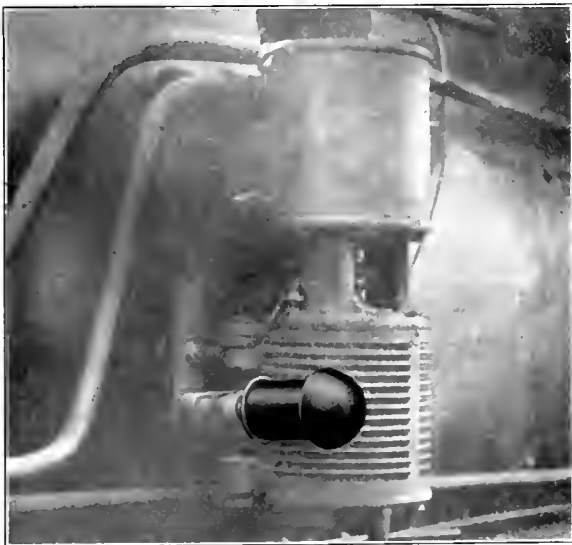

Strainer Applied to the Air Pump

the cylinder. This cleans the air of foreign matter before it passes to the compressor. The strainer is provided with a hood that overlaps the outer wall of the cylinder for one inch,

so that the air is drawn in from the under side of the hood and not directly into the strainer. This construction prevents rain or snow from getting into the strainer and finally working into the cylinder. It also prevents the possibility of squirting oil into the compressor, a practice that is becoming too common with the enginemen. The curled hair being soaked with oil will prevent the strainer from freezing in cold weather.

HACK SAW MACHINE

A new hack saw machine has been placed on the market by the L. S. Starrett Company, Athol, Mass., which includes a number of interesting features. It is the first machine to be put on the market by this company, and was developed because of its connection in the metal cutting industries where its hack saw blades are used. There are four features in the machine that will be especially appreciated by practical shop men. The first is the stroke adjustment, which makes possible a stroke of practically the full length of the blade, no matter what the size of the stock may be. This insures uniform wear of the blades and greater output. The second feature is the foot treadle for raising the saw frame. By it the operator's weight raises the saw instead of requiring him to exert his strength in lifting. This also will save time in cutting. The third feature is an oil dash pot controlling the descent of the saw. This dash pot allows the

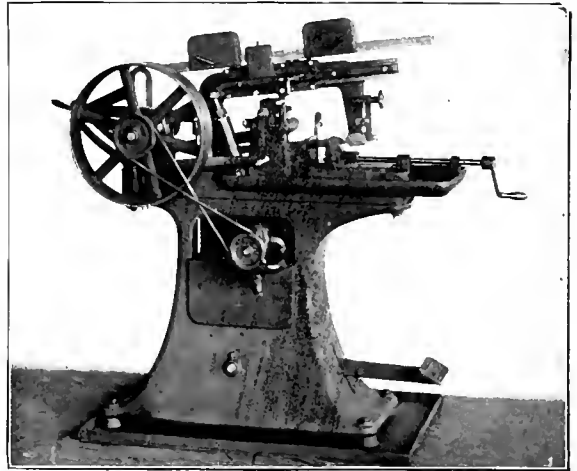

Hack Saw with Foot Operated Return

machine to be started when the frame is up and prevents it from dropping suddenly and breaking the saw. It also prevents the blade from cutting into the work too rapidly thus protecting the teeth and the saw. The fourth feature is the automatic locking device which prevents the saw dragging on the return stroke and holds the saw frame at any height when the machine is stopped for setting the work.

The saw frame is mounted on a rectangular slide with a bearing 11¼ in. long, accurately fitted with an adjustment for wear and provided with a quick-acting saw tightener to hold the blades square. The stroke of the saw is adjustable for stock from 1 in. to 6 in. in diameter. A pump and lubricant tank are located inside the base and may be quickly removed for cleaning, although this is seldom necessary as chips are retained in the pan of the bed and easily removed. The machine is intended to take 14-in. saws but 12 or 13 in. saws may also be used. The height over all is 48 in. and the height to the top of the table is 28 in. The floor space which this machine occupies is 14 in. by 32 in.

A MAGNETIC PYROMETER

In the heat treatment of steel, the most important thing is to know when the material has reached the critical temperature. It is not the same for all steel, but varies according to the chemical composition.

A pyrometer is shown in the drawing which takes advantage of the fact that in the process of heating steel, it loses its magnetic properties just at the critical point. This pyrometer, which is the product of the Gibb Instrument Company, Pittsburgh, Pa., consists of a small transformer connected on one side to a convenient power line and on the other side to the portable instrument. The portable portion has an indicator mounted on a hollow rod with a handle and switch on one end and a search coil on the other end. Contact is made with the steel in the furnace through the search coil. The surface of the steel in time becomes non-

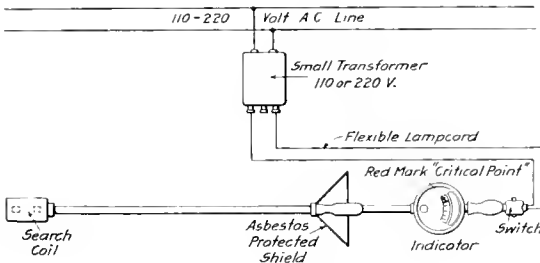
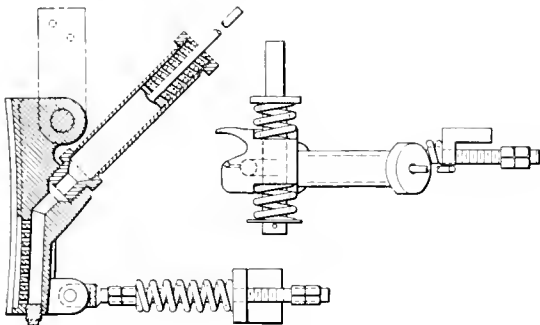

Diagram of Wiring and Pyrometer

magnetic, or in other words reaches the critical temperature. This is shown on the indicator by an approach of the needle towards a heavy red line. As the heat penetrates to the inside of the steel, the needle gradually approaches closer until it finally stands over the mark, signifying that the entire body of metal has reached the critical point. The instrument does not measure temperature, no indication of temperature being given when the critical point is reached. It is claimed that most of the ills due to imperfect heat-treatment are overcome by keeping from the operators the knowledge of what is the actual temperature.

A FLANGE LUBRICATOR

A flange lubricator, using driving box grease or similar lubricant, has been patented by H. S. Rauch, general foreman of the New York Central shops at Avis, Pa. This device is now applied to a passenger locomotive and it is re-



A Flange Lubricator Using Hard Grease

ported that several other installations will be made in the near future on locomotives in other classes of service.

It will be noted from the drawing that a hanger is provided so that the lubricator may be suspended from a convenient location in line with the driving wheel. Lateral

motion is taken care of by means of a loose fitting hanger pin on the lubricator. The lubricator proper is in the form of a shoe which fits against the driving wheel. A number of small holes in the shoe extend to a chamber which holds the grease. A piston with a spring behind it is provided to force the grease through these holes. In order to have the shoe constantly against the wheel, a second connection is provided, one end of which may be attached to any convenient stationary part of the locomotive. There is a spring and a jam nut on this connection which is adjusted to give pressure between the wheel and the shoe face. A sufficient amount of heat is generated to keep the grease in condition to flow through the small holes and onto the driving wheel flange.

One important feature in the cost of operation of this lubricator is that waste driving box compound can be used as a lubricant. The carbonized portion is removed from the waste driving box grease cakes, and, instead of being thrown out, is saved for use in the flange lubricator.

FASTENING CROSSHEAD SHOES

A crosshead which does away with reamed holes and fitted bolts to hold the shoes in place is shown in the drawing. Such an arrangement allows the free interchange of shoes on locomotives of similar classes, a condition that may mean

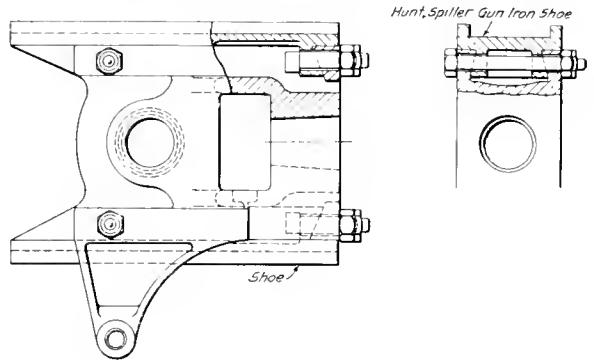

Fig. 1—Shoe Fastening as Applied to Crosshead with Piston Rod Held by a Nut

a great deal in increasing the roundhouse and shop output. This crosshead is known as the Markel design and has been patented by Charles Markel, locomotive inspector of the Chicago & North Western.

Each shoe is held by but two bolts, one for the long axis

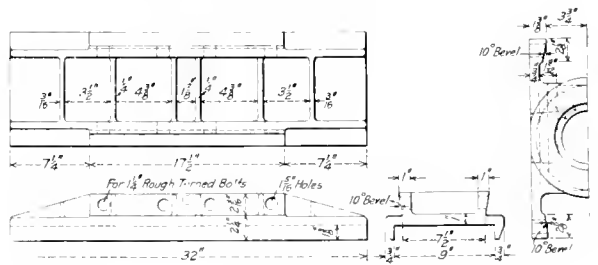

Fig. 2—Shoe Fastening as Applied to Crosshead with Piston Rod Held by a Key

and the other running across the crosshead, on shoes applied on cross heads with the piston rod held by a nut. This application is shown in Fig. 1. At each point where the bolts pass through, a beveled surface will be noted on both the shoe and crosshead. When the bolts are drawn up tight, a wedging action takes place, which holds the shoe in place.

As there are no reamed fits to wear, the arrangement when once applied should last for the life of the wearing face of the shoe.

The same method applied to crossheads in which the piston rod is held by a key is shown in Fig. 2. On this style, no end bolts are used; all bolts run across the crosshead and the number is increased to four per shoe.

The Chicago & North Western is reported as having 110 of its modern passenger and freight locomotives fitted up with this style of crosshead. It is also converting its old crossheads as rapidly as the locomotives pass through the shops for classified repairs.

A BOILER METAL TREATMENT

A boiler metal treatment called Perolin has been introduced into the railway field recently by the Perolin Railway Service Company, St. Louis, Mo. This product has been used in stationary practice for the past seven years, and over 40,000 boiler plants are now using it. It is being used in locomotive service by several roads, and has been found to give satisfactory service. Perolin treats the boiler metal and is not a boiler compound, or a chemical water treatment. It is a viscous, non-volatile, mineral liquid which has an affinity for hot metal and a high coefficient of expansion. When injected into the boiler through a short pipe or syphon attached to the suction side of the injector it diffuses through the water, and being attracted to the hot boiler metal, is drawn through the pores, cracks, and crevices of the scale into direct contact with the metal. As its temperature is raised it expands, reaching its maximum expansion at 500 deg. The expansion force exerted between the scale and the metal removes the scale mechanically. During and after

tube sheets and stay bolts has been increased by its use. With cleaner boilers the fuel consumption will be decreased, and this is one of the results that have been realized by its use. Where Perolin has been used it has been found unnecessary to erect and operate water treating plants which require attention with every change in the analysis of the water throughout the year. The company provides special representatives for the service of the railroads using Perolin to see that it is being properly applied to the locomotives and that the roads are obtaining the fullest possible benefit from its use.

MOTOR DRIVEN FOUR-PLUNGER PUMP

The hydraulic pump shown in the illustration is of the horizontal, four-plunger type and is intended to fill the requirements for a simple, heavy duty pump for applying a large volume of water or other similar fluid against a high pressure.

This pump, which is made by the Hydraulic Press Manufacturing Company, Mount Gilead, Ohio, is designed so that it may be equipped with 16 different sizes of plungers ranging from 1 3/8 in. to 5 in. in diameter, advancing by quarter inches. The water cylinders are made of forged steel for the highest pressures. For the medium pressures, 1,500 lb. to 2,900 lb. per sq. in. inclusive, cast steel is used, and for the lowest pressures the cylinders are semi-steel. The pressures range from 9,500 lb. to 700 lb. per sq. in., and the water capacity from 24 to 326 gallons per minute. All sizes of this pump have bronze valve seats and bronze or nickel-steel valves.

A 150 h. p. motor is required to operate the pump. A flexible shaft coupling is provided for motor connection and

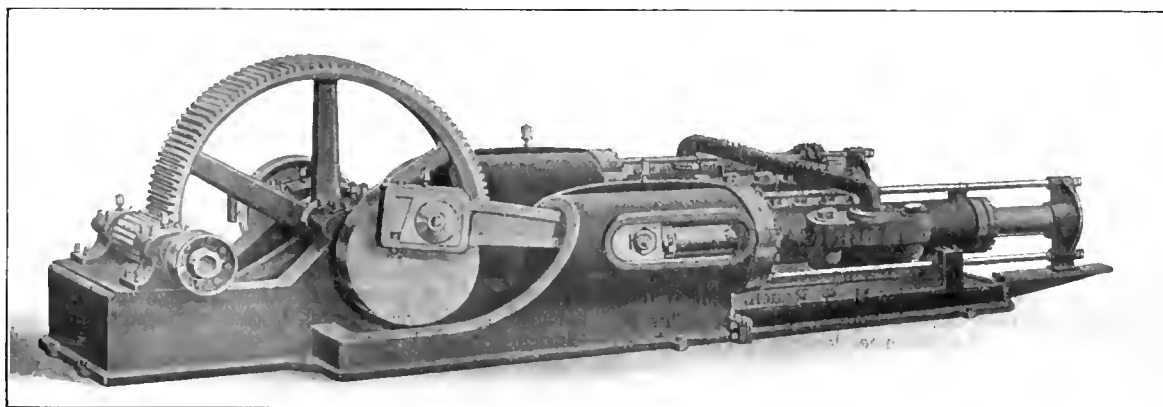

High Pressure Motor Driven Pump

the removal of the scale a thin heat conducting film of Perolin is established on the metal, which prevents sediment from baking on in the form of scale, and at the same time it protects the metal against pitting and corrosion. Through its "colloidal action" Perolin will prevent boiler foaming and it has been found that it will give satisfactory results irrespective of the kind of water used.

In locomotive service Perolin is fed to the engine through the injector at the roundhouse by the hostler when he is preparing the engine for service. None is required to be fed to the engine by the engineer or fireman while on the road. Where this treatment has been used in locomotive service it has been found that engine failures due to poor water have been reduced, that the mileage between boiler washings has been increased three to four times, that less tube and tube sheet work were required, with a consequent saving in firebox repairs and that the life of the tubes and

any 150-h. p. motor having a speed of from 450 r. p. m. to 750 r. p. m. may be used. The speed of the crank shaft is 60 r. p. m. The stroke of the plungers is 16 in., the two cranks being set at 90 deg. so that a more uniform flow of fluid may be obtained than with a triplex pump.

At all points where the strain and wear is most severe, the parts such as main bearings, connecting rod ends, crosshead guides, valves and valve seats, are of easy access for adjustment and replacement. The frame or pump bed consists of two heavy castings securely bolted together. The crosshead guides and main bearing containers are machined in this frame. This insures perfect alignment and gives the most rigid construction. The pump occupies a floor space of 18 ft. 8 in. in length by 6 ft. 10 in. in width. While the illustration shows the pump equipped with a spur gear and pinion, a herringbone gear and pinion may be furnished if desired.

PORTABLE PILLAR HOIST

The Ingersoll-Rand Company, New York, has recently introduced a portable hoist for the use of those who prefer manila rope to wire rope for light hoisting and hauling. These hoists are particularly adaptable for service in railroad yards where compressed air is available. They have been in active service since the latter part of 1914 and are now used extensively by industrial plants in their yards for shifting cars and by railroads, in coal mining service.

The hoist has a lifting capacity of 600 lb. and weighs less than 315 lb. fully equipped. It is 21½ in. long by 31¼ in. wide and 23 in. high. The drum is 7 in. in diameter by 17 in. long, with 5-in. flanges and accommodates 300 ft. of 7/8 in. manila rope. The base is so arranged that it may

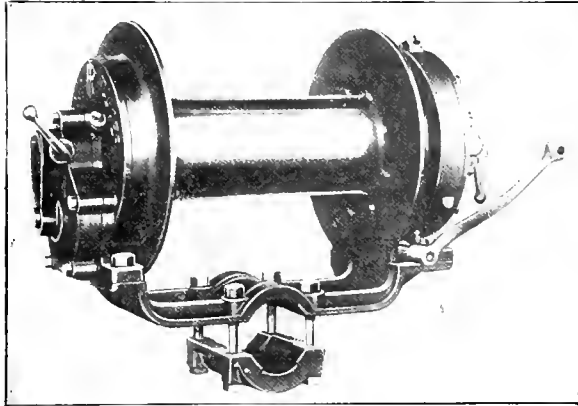

Ingersoll-Rand Pillar Hoist

be clamped to a circular column or pipe and by removing the clamps can be readily bolted to any convenient support.

The square piston, reversible driving engine, drum release clutch and worm operated hand brake are essentially the same as in the portable hoist described in the *Railway Mechanical Engineer* of September, 1914, the main differences being in the diameter and length of the drum, the width of the flanges and the main frame and over-all dimensions.

This hoist is built for operation either by compressed air or steam. Although designed primarily for underground work, it is adaptable for general hoisting and hauling in quarries and industrial plants.

TUBE BORING AND FACING MACHINE

A tube boring and facing machine which is adapted to such work as bushings, sleeves, cylinders, liners, or other work, which can be held advantageously in saddles is shown herewith. One feature that will be noted is that with a comparatively small machine a long boring travel is obtainable.

This machine, built by the Pedrick Tool & Machine Company, Philadelphia, Pa., has a boring bar which is supported in three pedestals. The pedestals are so designed that spacing blocks may be used to raise them in case of need, without interfering with the other mechanism. A direct-connected variable speed motor drives the bar through compound gearing, however, if desired belt drive can be furnished. The bearings are all bush lined. The cutter head travels along the bar and is controlled by an automatic, reversible feed, having three changes instantly available. The saddles for holding the work may be plain, as in the photograph, or furnished with four adjusting screws for miscellaneous requirements.

These saddles are concentric with the bar, in fact, they are bored out by the bar after it is fitted to the bed plate. Like the pedestals they are movable along the bed and are securely

held in position by substantial studs fitting the two T-slots, which run full length of the bed on both sides.

The cutter heads have four arms for carrying an equal number of tools, although it is claimed a single tool will do excellent work, owing to the strong construction and substantial design. The photograph shows a facing arm on the bar for facing the flanges or ends of the tubes or cylinders.

This machine is adaptable to railway shops, industrial

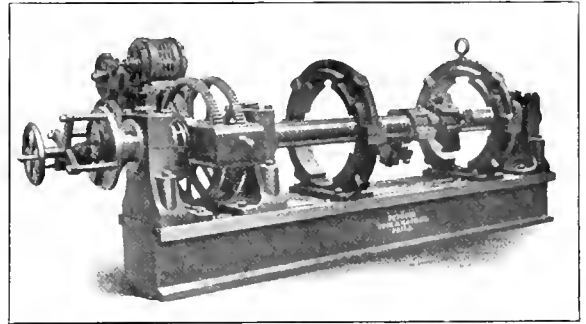

A Machine for Tube Boring and Facing

plants and shipyards, where boring of sleeves and tubes is a constant occurrence, and it will release more valuable equipment for other work. It is economical of floor space and is self-contained.

A SELF-CENTERING ROLLER SIDE BEARING

A self-centering roller side bearing is shown in the photograph, which provides for rolling contact between the bearings for ordinary angular movements of the truck and sliding contact for movements of greater extent.

This roller side bearing is made by the Wine Railway Appliance Company, Toledo, Ohio. The roller is contained in a malleable housing, which bolts onto the top of the truck side frame, in the bottom of which is placed a spring steel plate with two rivets in the center acting as guiding lugs. In

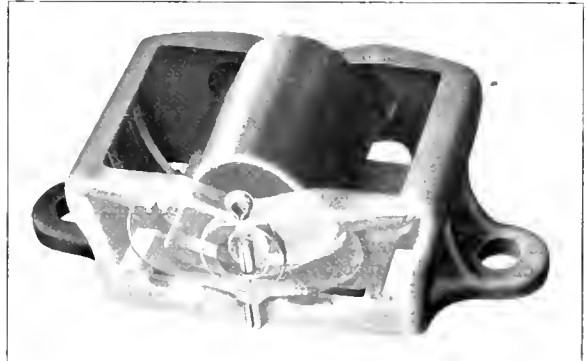

Roller Bearing In Center Position

the bottom of the steel roller are two holes fitting over these lugs. There is also a hole through the long axis of the roller; in this is slipped a wrought iron pin, the ends of which pass through slots in the housing. While the bearing is rolling, this pin is free to move in the slots. It is prevented from working out by means of a cotter

The special feature of this bearing is that after completing the rolling travel, the roller has turned over on its side and any sliding travel occurs on the flat surface; thus scoring and chafing do not take place on the cylindrical surface.

Railway Mechanical Engineer

(Formerly the RAILWAY AGE GAZETTE, MECHANICAL EDITION
with which the AMERICAN ENGINEER was incorporated)

PUBLISHED ON THE FIRST THURSDAY OF EVERY MONTH BY THE
SIMMONS-BOARDMAN PUBLISHING COMPANY

EDWARD A. SIMMONS, *President* L. B. SHERMAN, *Vice-President*
HENRY LEE, *Vice-President and Treasurer* M. H. WIUM, *Secretary*
WOOLWORTH BUILDING, NEW YORK, N. Y.
F. H. THOMPSON, *Business Manager*, CHICAGO.

Chicago: Transportation Bldg. Cleveland: Citizens' Bldg.
Washington: Honie Life Bldg.
London: Queen Anne's Chambers, Westminster.

ROY V. WRIGHT, *Editor*
R. E. THAYER, *Managing Editor*

C. B. PECK, *Associate Editor* E. S. BARNUM, *Associate Editor*

Entered at the Post Office at New York, N. Y., as mail matter of the second class.

Subscriptions, including the eight daily editions of the *Railway Age Gazette* published in June in connection with the annual conventions of the Master Car Builders' and American Railway Master Mechanics' Associations, payable in advance and postage free: United States, Canada and Mexico, \$2.00 a year; Foreign Countries (excepting daily editions), \$3.00 a year; Single Copy, 20 cents.

WE GUARANTEE that of this issue 9,100 copies were printed; that of these 9,100 copies 7,758 were mailed to regular paid subscribers, 112 were provided for counter and news companies' sales, 522 were mailed to advertisers, exchanges and correspondents, and 708 were provided for new subscriptions, samples, copies lost in the mail and office use; that the total copies printed this year to date were 9,100, an average of 9,100 copies a month.

THE RAILWAY MECHANICAL ENGINEER is a member of the Audit Bureau of Circulations.

VOLUME 91

JANUARY, 1917

NUMBER 1

CONTENTS

EDITORIALS:		SHOP PRACTICE:	
Change in Fiscal Year.....	1	Tools for Making Locomotive Safety Chains.....	35
Higher Postage Proposed for Magazines.....	1	Pneumatic Bolt Clamp.....	35
The Draft Gear Problem.....	1	Indicator for Placing Jacks.....	36
Benefits from Convention Attendance.....	1	A Use for Old Boiler Tubes.....	36
Mechanical Department Prospects for 1917.....	2	Flanging Boiler Sheets Cold.....	36
The New Headlight Rule.....	2	"Fired" for the Good of the Service.....	37
The Hot Box Competition.....	2	Reclaiming Wedges with Broken Flanges.....	39
Railway Supplies and Foreign Markets.....	3	The Use of Compressed Air in Railroad Shops.....	39
The Standard Box Car.....	3	The Electric Welding Process.....	41
Machine Tool Equipment in Railway Shops.....	4	Lathe Centers and Drill Press and Milling Machine Sockets.....	43
New Books.....	4	Mounted Wheel Truck.....	44
		Saving Metal in Valve Bushings.....	44
GENERAL:		NEW DEVICES:	
Car and Locomotive Orders in 1916.....	5	Car Ventilating Shutter.....	45
Steam Pipe Joint Rings.....	9	A Rod and Drawbar Upsetting Machine.....	45
Annual Report of the Chief Inspector of Locomotive Boilers.....	9	A Car-Wheel Lathe.....	45
Pulverized Fuel for Locomotives.....	11	The Wilson Arc Welder.....	47
Tabular Comparison of Locomotives of the Mountain, Pacific and 10-Wheel Types.....	15	Air Strainer for Locomotive Air Pumps.....	48
Tabular Comparison of Locomotives of the Santa Fe and Consolidation Types.....	16	Hack Saw Machine.....	48
Tabular Comparison of Mailer and Consolidation Locomotives.....	17	A Magnetic Pyrometer.....	49
Tabular Comparison of Switching Locomotives.....	18	A Flange Lubricator.....	49
		Fastening Cross-head Shoes.....	49
CAR DEPARTMENT:		A Boiler Metal Treatment.....	50
Practical Tests of Freight Car Paint.....	19	Portable Pillar Hoist.....	51
Interchange Inspection.....	20	Tube Boring and Facing Machine.....	51
Hot Box Problem Not Insurmountable.....	21	A Self-Centering Roller Slide Bearing.....	51
Interpretations of M. C. B. Rules.....	23		
A Dining Car Water Heater.....	24	NEWS DEPARTMENT:	
Car Department Organization and Efficiency.....	25	Notes.....	52
Examples of Recent Design in Refrigerator Cars.....	26	Meetings and Conventions.....	54
Examples of Recent Design in Box Cars.....	28	Personal Mention.....	54
Examples of Recent Design in Automobile Cars.....	28	Supply Trade Notes.....	56
Examples of Recent Design in Gondola and Hopper Cars.....	29	Catalogues.....	59
Examples of Recent Design in Stock Cars.....	31		
Examples of Recent Design in Chair Cars.....	31		
Examples of Recent Design in Vestibule Steel Coaches.....	32		
Examples of Recent Design in Dining Cars.....	34		

The Interstate Commerce Commission has issued a summary of the monthly reports for Class 1 roads for the fiscal year ending June 30, 1916, subject to revision, showing that railway operating revenues amounted to \$3,396,808,000; operating expenses amounted to \$2,220,004,000; net revenue to \$1,176,804,000; operating income to \$1,029,243,000; operating revenues per mile, \$14,818, against \$12,678 last year; expenses, \$9,684 against \$8,915; operating income, \$4,490, against \$3,169.

The Pennsylvania Railroad has recently organized two new apprentice schools, one at Meadows, N. J., and the other at Trenton, N. J., bringing the total number of schools to ten. All schools are in direct charge of the supervisor of apprentice schools, at Altoona, Pa., Paul E. Reinhardt, who was formerly instructor at the Altoona school. Preparations are being made to establish a school at Baltimore, Md., and when it is in operation, apprentice school instruction will

be established on Lines East at all shops employing apprentices.

The Executive Committee of the Master Car Builders' Association has postponed the date at which the Tank Car Specifications for Class 3 and Class 4 tank cars are to go into effect to May 1, 1917. It has also changed date from which cars not properly equipped with safety appliances shall not be interchanged, adding a second paragraph to Section *n* of Rule 3, of the Rules of Interchange to read: "After June 1, 1917, no foreign car will be accepted in interchange unless properly equipped with United States Safety Appliances or United States Safety Appliances, Standard." The law requiring the complete equipment of cars with the required appliances goes into effect July 1, 1917.

Tests to determine the relative value of various grades of coal in locomotive service are now in progress at the loco-

motive testing plant of the University of Illinois at Urbana, Ill. These tests are being made under the auspices of the International Railway Fuel Association, the University of Illinois and the U. S. Bureau of Mines, and all members of the fuel association and others who are interested are urged to visit the laboratory to witness the tests, which will be completed about January 25. Specific information regarding the operation of the laboratory on any particular date during the course of the tests may be had by writing or wiring Professor Edward C. Schmidt, Room 101, Transportation Building, University of Illinois, Urbana, Ill.

The Pennsylvania Railroad has adopted a scheme, covering the whole of its territory, under which applications for work will be received by every one of the 1,500 station agents on the lines, each becoming, in effect, an employment agent. An employment clearing house is to be established in the general manager's department at Philadelphia. The purpose of the new plan is to encourage the entrance into the service of a greater number of men who live in the neighborhood of the road. It will now be easy for anyone to make an application, and to ascertain what lines of service are open, and in what localities work for which he is fitted may be obtained. The agent will interview each applicant, learn his capabilities as fully as possible, and direct him to the nearest shop foreman, supervisor, trainmaster or road foreman of engines, who may want men. Each general superintendent will forward, once a week, to the general manager a list showing the number of vacancies on his grand division for shop laborers, car repairmen, car cleaners, engine cleaners, brakemen, firemen, freight handlers and trackmen.

A. O. Wharton, St. Louis representative of the American Federation of Labor, has given out a statement to the effect that the majority of shop employees of six different unions, working on 26 railroads in the west, have voted to refuse the compromise offer of the roads to the men's demands for an increase of five cents an hour and an eight-hour day. The roads propose to increase wages by two and one-half cents an hour and to grant the eight-hour day to men on stationary work. Negotiations, it is said, will be continued by the organized employees and the companies involved. The Chicago & Alton has come to an agreement with its men, granted an increase of 2½ cents an hour to all skilled mechanics and 2 cents an hour to apprentices, effective August 16. It has also granted a nine-hour day to all shopmen. The Chicago, Rock Island & Pacific also has reached an agreement with its men. It has granted an increase of 2½ cents an hour, flat, for mechanics and their helpers and helper apprentices, and 1½ cents an hour for other apprentices. The present working conditions are to continue with the exception that men engaged in rebuilding and repairing cars will work nine hours a day instead of ten.

The Chicago, Milwaukee & St. Paul added 76 miles to its electrified section of road on December 11, completing the electrification from Harlowton, Mont., to East Portal, at the east end of the St. Paul Pass tunnel, a total distance of 406 miles. A length of only 34 miles remains to be electrified,

which includes 1.7 miles through the tunnel. The lining of the tunnel with concrete has been completed, and the bonding of rails and the construction of trolleys are under way. The St. Paul has ordered 44 electric locomotives, 37 of which are now in use. One of these recently hauled a special train 339 miles. This train consisted of a baggage car and four business cars, and was occupied by L. W. Hill, chairman of the board and president, and R. Budd, assistant to the president of the Great Northern; J. M. Hamnford, president, and George T. Slade, first vice-president of the Northern Pacific.

The run was from Alberton, Mont., to Harlowton and is the longest ever made by any locomotive on the system. The engine received no special care en route, and after arriving at Harlowton was ready to return to its starting point without passing through a roundhouse or receiving any further attention.

CARS AND LOCOMOTIVES ORDERED IN DECEMBER

Elsewhere in this issue there appears an article dealing with the equipment market in 1916 from the standpoint of the amount of business done, the prices paid, the tendencies in car and locomotive design and the output of cars and locomotives.

The car and locomotive orders in December totaled:

	Locomotives	Freight Cars	Passenger Cars
Domestic	288	17,424	125
Foreign	477	7,000	...
Total	765	24,424	125

Among the important orders were the following:

LOCOMOTIVES			
Road	No.	Type	Builder
Arlinson, Topeka & Santa Fe..	28	Mikado	Baldwin
	2	Mountain	Baldwin
Baltimore & Ohio.....	30	Mallet	Baldwin
	10	Pacific	Baldwin
Chicago, Burlington & Quincy.	20	Mikado	Baldwin
	10	Santa Fe.....	Baldwin
	15	Mikado	Baldwin
Great Northern	15	Mikado	Baldwin
St. Louis-San Francisco.....	30	Sante Fe	Baldwin
Virginian	10	Mallet	Baldwin
British Government	40	Consolidation ..	Canadian
French Government	100	Consolidation ..	American
Paris-Lyon-Mediterranean ..	110	Mikado	American
Russian Government	110	Decapod	Baldwin
	30	Decapod	Canadian

FREIGHT CARS			
Road	No.	Type	Builder
Baltimore & Ohio.....	1,000	Hopper	Std. Steel Pullman
	1,000	Hopper	Am. C. & F
New York Central.....	1,200	Hopper	West Steel
Los Angeles & Salt Lake.....	1,600	Gen. service ..	Co. Shops
Norfolk & Western.....	1,000	Gondola	Mr. Vernon
	1,000	Box	West Steel
Northern Pacific	500	Auto	West. Steel
Union Pacific	1,800	Refrigerator ..	Am. C. & F
	700-900	Refrigerator ..	Co. Shops
	200	Box	Seattle C. & F.
	200	Box	Twofly Bros
	100	Tank	Gen'l Am.
Russian Government	2,000	Gondola	Am. C. & F
	1,500	Gondola	Std. Steel
	3,500	Pool	Eastern

PASSENGER CARS			
Road	No.	Type	Builder
Central of New Jersey.....	26	Coaches	Pullman
	5	Commodation ..	Pullman
Erie	50	Express	Osg. Brad

RAILROAD CLUB MEETINGS

Club	Next Meeting	Title of Paper	Author	Secretary	Address
Canadian	Jan. 9, 1917	Passenger Car Painting	Thos. Marshall..	James Powell..	P. O. Box 7, St. Lambert, Que.
Central	Jan. 12, 1917	Annual Meeting; Election of Officers ..	Harry D. Vought.	Harry D. Vought.	95 Liberty St., New York.
Cincinnati	Feb. 13, 1917	Demonstration of the Automatic Stop ..	Julian Peggs.....	H. Boutet.....	101 Carew Bldg., Cincinnati, Ohio.
New England.....	Jan. 9, 1917	Maintenance of Air Brakes on Freight Car Equipment	H. S. Walton.....	Wm. Cade, Jr....	683 Atlantic Ave., Boston, Mass.
New York.....	Jan. 19, 1917	Accident Prevention	Marcus N. Dow..	Harry D. Vought.	95 Liberty St., New York.
Pittsburgh	Jan. 26, 1917	The Man Problem	D. C. Bueh.....	J. R. Anderson..	307 Penn Station, Pittsburgh, Pa.
Richmond	Jan. 19, 1917	Glacier National Park and Blackfoot Indians. Travelogue with Moving Pictures.	L. D. Kitchell..	F. O. Robinson..	C & O Railway, Richmond, Va.
St. Louis.....	Jan. 12, 1917	Electrifications of Steam Railroads. Moving Pictures	B. W. Frauenthal.	Union Station, St. Louis, Mo.
South'n & S'w'rn.	A. J. Merrill.....	Box 1295, Atlanta, Ga.
Western	Jan. 15, 1917	Accounting	Frank Ney.....	Jos. W. Taylor..	1112 Karpen Bldg., Chicago.

I. C. C. MODIFIES HEADLIGHT ORDER

As a result of hearings before the Interstate Commerce Commission in November at the request of the railways that they might present additional evidence giving the results of headlight tests, the commission has issued a modification of rules 29 and 31 of its order regarding the use of locomotive headlights, and postponed the effective date from January 1 to July 1. Rule 29, applying to locomotives in road service, is amended to provide that "each locomotive used in road service between sunset and sunrise shall have a headlight which shall afford sufficient illumination to enable a person in the cab of such locomotive, who possesses the usual visual capacity required of locomotive enginemen, to see in a clear atmosphere a dark object as large as a man of average size standing erect at a distance of at least 800 feet ahead and in front of such headlight; and such headlight must be maintained in good condition." This makes the language more specific than in the previous form of the order, and reduces the distance requirement from 1,000 feet. Rule 31, applying to locomotives in yard service, provides that two lights shall be used, giving sufficient illumination to see the object for a distance of 300 feet. These rules apply to locomotives constructed after July 1. For locomotives constructed prior to that date the changes required are to be made the first time they are shopped for general repairs after that date, and all locomotives must be so equipped before July 1, 1920.

MEETINGS AND CONVENTIONS

Master Boiler Makers' Association.—The eleventh annual convention of the Master Boiler Makers' Association will be held May 22 to 25, 1917, at the Hotel Jefferson, Richmond, Va.

Railway Business Association Dinner.—F. A. Delano, member of the Federal Reserve Board, former president of the Chicago, Indianapolis & Louisville, and Alfred P. Thom, general counsel of the Southern Railway and also general counsel of the Railway Executives' Advisory Committee are announced as the speakers for the eighth annual dinner of the Railway Business Association which will be held at the Waldorf-Astoria Hotel, New York, Tuesday evening, January 16, 1917. The business meeting of the association occurs at 11 a. m. at the Waldorf-Astoria, the election of officers at 1.30 p. m. and the dinner at 7 p. m.

The following list gives names of secretaries, dates of next or regular meetings and places of meeting of mechanical associations:

- AIR BRAKE ASSOCIATION.**—F. M. Nellis, Room 3014, 165 Broadway, New York City. Convention, May 1-4, 1917, Memphis, Tenn.
- AMERICAN RAILROAD MASTER TINSNERS', COPPERSMITHS' AND PIPEFITTERS' ASSOCIATION.**—O. E. Schlink, 485 W. Fifth St., Peru, Ind.
- AMERICAN RAILWAY MASTER MECHANICS' ASSOCIATION.**—I. W. Taylor, Karpen Building, Chicago.
- AMERICAN RAILWAY TOOL FOREMEN'S ASSOCIATION.**—R. D. Fletcher, Belt Railway, Chicago.
- AMERICAN SOCIETY FOR TESTING MATERIALS.**—Prof. E. Marburg, University of Pennsylvania, Philadelphia, Pa.
- AMERICAN SOCIETY OF MECHANICAL ENGINEERS.**—Calvin W. Rice, 29 W. Thirty-ninth St., New York. Annual Meeting, December 5-8, 1916, New York.
- ASSOCIATION OF RAILWAY ELECTRICAL ENGINEERS.**—Joseph A. Andreucetti, C. & N. W., Room 411, C. & N. W. Station, Chicago.
- CAR FOREMEN'S ASSOCIATION OF CHICAGO.**—Aaron Klinc, 841 Lawlor Ave., Chicago. Second Monday in month, except June, July and August, Hotel La Salle, Chicago.
- CHIEF INTERCHANGE CAR INSPECTORS' AND CAR FOREMEN'S ASSOCIATION.**—W. R. McMurd, New York Central, Albany, N. Y.
- INTERNATIONAL RAILROAD MASTER BLACKSMITHS' ASSOCIATION.**—A. L. Woodworth, C. H. & D., Lima, Ohio.
- INTERNATIONAL RAILWAY FUEL ASSOCIATION.**—J. G. Crawford, 547 W. Jackson Blvd., Chicago. Convention, May, 1917, Chicago.
- INTERNATIONAL RAILWAY GENERAL FOREMEN'S ASSOCIATION.**—William Hall, 1126 W. Broadway, Windsor, Mich.
- MASTER BOILERMAKERS' ASSOCIATION.**—Harry D. Vought, 95 Liberty St., New York. Convention, May 22-25, 1917, Richmond, Va.
- MASTER CAR BUILDERS' ASSOCIATION.**—J. W. Taylor, Karpen Building, Chicago.
- MASTER CAR AND LOCOMOTIVE PAINTERS' ASSOCIATION OF U. S. AND CANADA.**—A. P. Dane, E. & M., Reading, Mass.
- NIAGARA FRONTIER CAR MEN'S ASSOCIATION.**—E. N. Frankenberger, 623 Brisbane Building, Buffalo, N. Y. Meetings, third Wednesday in month, New York Telephone Bldg., Buffalo, N. Y.
- RAILWAY STOREKEEPERS' ASSOCIATION.**—J. P. Murphy, Box C, Collinwood, Ohio.
- TRAVELING ENGINEERS' ASSOCIATION.**—W. O. Thompson, N. Y. C. R. R., Cleveland, Ohio.

PERSONAL MENTION

GENERAL

SAMUEL T. ARMSTRONG, division master mechanic of the International & Great Northern, has been appointed superintendent of motive power, succeeding F. W. Taylor, who has resigned, effective January 1, to accept service with another company.

D. F. CRAWFORD, general superintendent of motive power of the Pennsylvania Lines West, at Pittsburgh, Pa., has been appointed general manager.

T. K. FAHERTY, road foreman of engines of the Baltimore & Ohio, with office at Grafton, W. Va., has been promoted to supervisor of locomotive operation of the West Virginia district, with headquarters at Wheeling, W. Va.

C. E. JONES has been appointed supervisor of fuel of the Canadian Northern, with headquarters at Toronto, Ont. He will be in charge of the distribution and accounting of all fuel, including that for locomotives, shops, stations, water stations and other purposes.

GEORGE McCORMICK, who has been appointed general superintendent of motive power of the Southern Pacific, lines west of El Paso, Tex., was born on July 15, 1872,



G. McCormick

He was graduated from the Agricultural and Mechanical College at Bryan, Tex., with the degree of mechanical engineer in 1891. He began railway work in 1891, as an apprentice in the shops of the Galveston, Harrisburg & San Antonio, at Houston, Tex. In a short time he was transferred to San Antonio, Tex., as a draftsman, returning to Houston in 1895 as chief draftsman. In 1900 he was appointed mechanical engineer, in which position he remained until December, 1911, when he went to El Paso, Tex., as assistant superintendent of the El Paso division. He held this latter connection until his appointment in February, 1913, as assistant general manager (mechanical) of all the Southern Pacific, Texas lines, with headquarters at Houston, Tex. His new headquarters will be at San Francisco, Cal., and his jurisdiction will include all the Southern Pacific lines in the States of New Mexico, Arizona, California, Oregon and Nevada.

G. C. NICHOLS, master mechanic of the Alabama, Tennessee & Northern at York, Ala., has been promoted to superintendent of motive power and equipment, with headquarters at York.

J. A. POWER, superintendent of shops of the Southern Pacific, Texas Lines, at Houston, Tex., has been appointed assistant general manager, succeeding George McCormick, with the same headquarters.

O. P. REESE, assistant engineer of motive power of the Pennsylvania Lines West, at Pittsburgh, Pa., has been appointed superintendent of motive power of the Central sys-

tem of the Lines West, succeeding P. F. Smith, Jr., who has been promoted.

P. F. SMITH, JR., superintendent of motive power of the Central system of the Pennsylvania Lines West, with office at Toledo, Ohio, has been appointed general superintendent of motive power of the Lines West, with headquarters at Pittsburgh, Pa., succeeding D. F. Crawford, promoted.

F. W. TAYLOR has been appointed superintendent of motive power of the Missouri, Kansas & Texas, with headquarters at Denison, Tex., succeeding W. L. Kellogg, who has resigned to accept service with another company. Mr. Taylor was born on October 24, 1875, at Water Valley, Miss. He entered railway service with the Illinois Central as a machinists' apprentice at Water Valley, Miss., in 1893. After several years' experience as an apprentice and as a journeyman machinist, he was appointed roundhouse foreman on October 1, 1901. In October, 1902, he was promoted to the position of general foreman, with headquarters at Jackson, Miss., where he served until October, 1903, when he was transferred to Louisville, Ky., as general foreman. On October 1, 1908, he was appointed master mechanic, with headquarters at Mattoon, Ill., and on April 1, 1912, was transferred to Waterloo, Ia., as master mechanic of the Minnesota and Iowa division. He was appointed superintendent of motive power of the International & Great Northern, with headquarters at Palestine, Tex., on January 1, 1915, which position he held at the time of his appointment as superintendent of motive power of the Missouri, Kansas & Texas effective January 1, 1917.

MASTER MECHANICS AND ROAD FOREMEN OF ENGINES

HARRY C. ALLEN has been appointed road foreman of engines on the Rocky Mountain division of the Northern Pacific with headquarters at Missoula, Mont., succeeding H. E. Day.

C. E. BESS, assistant general foreman of the Southern Pacific at Rosedale, Cal., has been appointed assistant master mechanic with headquarters at Sparks, Nev., succeeding Paul Jones, promoted.

JOHN BIRSE, whose appointment as district master mechanic, district 3, Transcontinental division of the Canadian Government Railway, was announced in these columns last month, has his headquarters at Fort William, Ont., instead of at Transcona, Man., as announced.

F. E. DYMOND, heretofore car foreman of the Grand Trunk Pacific at Smithers, B. C., has been appointed car foreman at Prince Rupert, B. C., succeeding C. A. McNiece, resigned.

W. H. EAKIN, formerly supervisor of fuel economy of the Chesapeake & Ohio, has been appointed road foreman of engines at Clifton Forge, Va.

C. GRIBBINS has been appointed division master mechanic of the Smiths Falls division of the Canadian Pacific with office at Smiths Falls, Ont., succeeding F. Ronaldson, promoted.

JOHN HANDFORD has been appointed general foreman of the Pere Marquette at St. Thomas, Ont., succeeding G. W. Cook, resigned.

PAUL JONES, assistant master mechanic of the Southern Pacific with office at Sparks, Nev., has been appointed a member of the efficiency committee of that company with headquarters at San Francisco, Cal.

RICHARD J. McDONALD, road foreman of engines on the Chicago & Alton at Bloomington, Ill., has been appointed trainmaster, with office at Roodhouse, Ill., succeeding T. F. Shuman, resigned.

W. H. SAMPLE, formerly master mechanic of the Grand Trunk, at Battle Creek, Mich., has been appointed master mechanic at Montreal, Que.

LOUIS E. THOMAS, formerly passenger car inspector of the Illinois Central, has been appointed traveling steam heat and air brake inspector of the Northern lines, with office at Chicago.

E. B. LE VAN has been appointed road foreman of engines of the Montana division of the Northern Pacific.

CAR DEPARTMENT

* G. S. CLARKE, car foreman of the Canadian Northern at Tollerton, Alta., has been appointed car foreman at Dauphin, Man.

J. H. CRAIG has been appointed car foreman of the Canadian Northern at Tollerton, Alta., succeeding G. S. Clarke, transferred.

C. R. STOKES has been appointed car foreman of the Canadian Northern at North Regina, Sask.

F. B. ZERCHER, formerly master car builder, Eastern lines, of the Canadian Pacific at Montreal, has been appointed master car builder of the Western lines of the Grand Trunk Railway, at Elsdon, Ill., succeeding A. Copony, resigned.

SHOP AND ENGINEHOUSE

G. MORTIMER has been appointed locomotive foreman of the Canadian Northern at Blue River, Sask.

J. W. SURLES, general foreman of the Southern Pacific at Houston, Texas, has been appointed superintendent of shops at that point, succeeding J. A. Power, who has been promoted.

PURCHASING AND STOREKEEPING

ROY BENSON, chief clerk in the purchasing department of the Chicago & Western Indiana and the Belt Railway of Chicago, has been appointed purchasing agent, succeeding George L. Pollock, resigned to go with another company.

EDWARD ORMOND GRIFFIN, purchasing agent and general storekeeper of the International & Great Northern here, has been appointed assistant to the first vice-president of the St.

St. Louis Southwestern, and assistant to the president of the St. Louis Southwestern of Texas, with jurisdiction over the department of purchasing and of materials and supplies, with headquarters at St. Louis, Mo. He was born on January 3, 1867, at Madison, N. C., and received his education at Brownsville College, Southwestern Baptist University and Nashville College. He began railway work with the International & Great Northern as secretary to the receiver, and in 1891 was promoted to chief clerk to the receiver and purchasing agent of the same road. From May, 1895, to June, 1897, he was assistant to the general manager, being then appointed assistant to the vice-president and general manager in charge of transportation. In 1903 he was made passenger and ticket agent, and in



E. O. Griffin

retary to the receiver, and in 1891 was promoted to chief clerk to the receiver and purchasing agent of the same road. From May, 1895, to June, 1897, he was assistant to the general manager, being then appointed assistant to the vice-president and general manager in charge of transportation. In 1903 he was made passenger and ticket agent, and in

1904 passenger and freight agent. In 1905 he was appointed Southwestern passenger agent for the Missouri Pacific, and then became demurrage agent for the same company's Texas Lines in 1908. He returned to the International & Great Northern in 1909, and in 1910 was appointed chief clerk to the superintendent. In June, 1911, he was made general storekeeper, and in May, 1914, he was promoted to general fuel and supply agent of the same road. On the resignation of the purchasing agent and general storekeeper in September, 1914, he was promoted to this position, which he held up to the time his present appointment became effective.

WILLIAM A. LINN, assistant purchasing agent of the Chicago, Milwaukee & St. Paul, has been appointed purchasing agent with office at Chicago, Ill. Mr. Linn was born at Waukesha, Wis., January 4, 1863. He was educated at Carroll College, Waukesha, and entered railway service in 1882 in the accounting department of the Chicago, Milwaukee & St. Paul, where he remained until 1887. From 1887 to 1890 he was bookkeeper in the purchasing department, being then promoted to chief clerk in this same office. In 1900 he was appointed assistant purchasing agent, with headquarters at Chicago, Ill., which position he held at the time his present promotion became effective. He succeeded John T. Crocker, retired.

H. L. MORGAN has been appointed general storekeeper of the St. Louis, Brownsville & Mexico, with office at Kingsville, Tex., succeeding L. C. McRoberts, assigned to other duties.

J. H. MORGAN, storekeeper of the Canadian Northern at Dauphin, Man., has been appointed storekeeper, with office at Port Mann, B. C.

A. H. MULCAHEY has been appointed assistant purchasing agent of the Grand Trunk Pacific, with headquarters at Winnipeg, Man.

R. M. NELSON has been appointed assistant purchasing agent of the Chesapeake & Ohio, with office at Richmond, Va.

H. D. PONTON has been appointed assistant general storekeeper of the Southern Pacific, Texas and Louisiana Lines, with headquarters at Houston, Tex.

C. B. PORTER, chief clerk to receiver of the International & Great Northern, has been appointed purchasing agent and general storekeeper, with office at Houston, Tex., succeeding E. O. Griffin, resigned to accept service with another company.

OBITUARY

HENRY MONKHOUSE, until two years ago president of the Rome Locomotive & Machine Works, Rome, N. Y., died in St. Paul, Minn., on November 9, at the age of about 72 years. Mr. Monkhouse was in railway mechanical department service for many years. He was acting master mechanic of the Chicago, Kansas & Nebraska division of the Chicago, Rock Island & Pacific from October, 1887, to November, 1890, following which, from November, 1890, to June, 1891, he was assistant general master mechanic and assistant general master car builder of the Chicago, Rock Island & Pacific lines west of the Missouri River. From June, 1891, to February 1, 1897, he was assistant superintendent of motive power and equipment of the same road; from February 1, 1897, to April 1, 1900, superintendent of machinery of the Chicago & Alton; and from July, 1900, to September, 1901, superintendent of motive power of the Chicago, Indianapolis & Louisville. In September, 1901, he was appointed general manager of the Compressed Air Company, becoming, later, president of the Rome Locomotive & Machine Works, as noted above.

SUPPLY TRADE NOTES

Charles B. Moore has resigned as vice-president and director of the Boss Nut Company, Chicago, Ill.

S. C. Stebbins, formerly western sales manager of the Lansing Company, Lansing, Mich., has been elected secretary of this company.

A. S. Blagden has been elected president of the American Malleables Company in place of W. G. Pearce who has been elected chairman of the board.

Edward L. Pollock, People's Gas building, Chicago, has been appointed western representative of the Wilson Welder & Metals Company, New York.

A. J. Boyle, formerly with the Pittsburgh Screw & Bolt Co., Pittsburgh, Pa., has been appointed general manager of the Boss Nut Company, Chicago, Ill.

Ike W. Lincoln has been appointed manager of the railroad and car material department of the C. A. Goodyear Lumber Company, Tomah, Wis., effective January 1.

J. L. Jackson, vice-president of the Duncan Lumber Company, Portland, Ore., has taken charge of the Chicago office of this company, succeeding I. W. Lincoln, resigned.

Charles Wiley, vice-president of John Wiley & Sons, New York, publishers of scientific books, died at his home in East Orange, N. J., December 3, at the age of 83 years.

John D. Ristine has been appointed manager of sales of the Perolin Railway Service Company, St. Louis, Mo. His headquarters will be located in the Peoples Gas building, Chicago.

Harry M. Evans has been appointed eastern sales manager of the Franklin Railway Supply Company with office at 30 Church street, New York. Mr. Evans was born at Meadville, Pa., and was educated in the public schools at that place. He began railroad work as a call boy on the Erie, and served in various positions in the mechanical, transportation and traffic departments of that road. He entered the mechanical department of the Franklin Railway Supply Company, October 1, 1908, as traveling representative and was promoted to assistant western sales manager last August, which position he held at the time of his recent appointment.



H. M. Evans

Alfred Blunt Jenkins, of Jenkins Brothers, New York, manufacturers of valves and rubber goods, died December 29, at his home in Llewellyn Park, West Orange, N. J., age 69.

Ralph G. Coburn, formerly eastern sales manager of the Franklin Railway Supply Company, will henceforth devote his entire time to the management of the electrical department and exploitation of the Stone-Franklin lighting equipment.

Robert Hughes, until recently engaged in commercial business at Toronto, Ont., has become associated with the National Railway Devices Company, Chicago, in the capacity of manager of sales.

W. W. Butler has been appointed a vice-president and managing director of the Canadian Car & Foundry Company, and F. A. Skelton, the secretary-treasurer, has also been made a vice-president.

J. L. Randolph has been elected vice-president of the Economy Devices Corporation with office at 30 Church street, New York. Mr. Randolph was born in Boston, Mass., August 25, 1878, attended the public schools and graduated from the English High School of that city. He began his railroad career as a machinist apprentice in the Concord, N. H., shops of the Northern Railroad, now a part of the Boston & Maine. Subsequently he served this road in the capacity of machinist, gang foreman, general foreman, master mechanic, and superintendent of shops at Keene, N. H. In April, 1911, he accepted a position with the Franklin Railway Supply Company in the mechanical department. In February, 1914, he was appointed eastern sales manager of the Economy Devices Corporation which position he held at the time of his recent appointment.



J. L. Randolph

Hugh E. Creer, formerly connected with the sales department of the Union Railway Equipment Company of Chicago, Ill., has been appointed special representative of the Camel Company, with headquarters at Chicago, Ill.

E. P. Hobson, formerly with the Sherwin-Williams Company, has been appointed railroad sales representative of the Barrett Company, with headquarters in the Illuminating Building, Cleveland, Ohio, effective January 1.

Holden & White, dealers in electric railway specialties, Chicago, Ill., have been appointed general sales agents by the Garland Ventilator Company, for the sale of Garland ventilators in the steam railway field, as well as in the electric railway field.

F. A. Purdy, Canadian representative of the Chicago Car Heating Company at 61 Dalhousie street, Montreal, has also been appointed direct representative of the U. S. Light & Heat Corporation to the railroads of Canada, and will henceforth represent both companies.

W. V. D. Wright, formerly sales agent of the Chicago district for the Railway Steel Spring Company, has been elected vice-president of the Edgewater Steel Company, which is constructing a plant at Pittsburgh, Pa., for the manufacture of locomotive tires and rolled steel wheels.

The Pyle-National Company, Chicago, announces the following appointments: Robert C. Shaal, eastern representative, with headquarters in New York; N. S. Kenney, representative, Munsey building, Baltimore, Md.; W. L. Jefferies, Jr., representative, Mutual building, Richmond, Va.

Burton W. Mudge, president of Mudge & Co., has been made vice-president of the Pilliod Company, in full charge of its western territory. Mudge & Co. has been the western representative of the Pilliod Company for the past four years.

A sketch and picture of Mr. Mudge appeared in the *Railway Mechanical Engineer* of October, 1916, page 547.

Announcement is made of a trustees' sale in bankruptcy by order of the United States District Court of the Cincinnati Equipment Company's railroad car repair shops, with 13 acres of land and concrete buildings, tracks, switches, etc., at Cullon's Station, Riverside, Cincinnati, Ohio. The property is on the Baltimore & Ohio and New York Central.

N. B. Ford, who for 10 years traveled for the Corbin Screw Corporation of New Britain, Conn., from its Chicago office, having his headquarters in Kansas City, and who left some two years ago to become connected with the Ford Chain Block & Manufacturing Company of Philadelphia, has re-entered the employ of the Corbin Screw Corporation as salesman, with headquarters in New Britain, and covering the territory formally traveled by A. H. Harrop.

The Allegheny Steel Tank Car Company, incorporated under the laws of Pennsylvania, has been formed to manufacture steel tank cars at Warren, Pa., and has purchased the plant and equipment of the Allegheny Foundry Company. The plant is to be opened in the near future, with a payroll of about \$100,000. The authorized capital stock is \$100,000. H. D. Kopf, president of the Hammond Iron Works, of Warren, is president of the new corporation; J. A. Schofield, vice-president; G. L. Craft, secretary; and A. J. Hazeltine, treasurer.

S. B. Taylor, sales manager of the S K F Ball Bearing Company, Hartford, Conn., has been elected vice-president of the company, succeeding F. B. Kirkbride, who remains on the board of the company. Mr. Taylor will remain in charge of sales. G. A. Ungar, former representative of the company in Cleveland, Detroit and Pittsburgh, has been appointed technical manager and chief engineer, succeeding Uno Forsberg, who returns to Sweden after completing his work of creating the manufacturing organization of the S K F Ball Bearing Company in this country.

Norman C. Naylor has been appointed sales agent of the Chicago district, in charge of the Chicago office, for the Railway Steel Spring Company of New York. Mr. Naylor has been in the employ of the Railway Steel Spring Company since 1902. He was born in Rochester, N. Y., June 3, 1881, and entered the employ of McKee-Fuller & Co. September 8, 1895. In June, 1896, he left this company to attend school in Colorado. He entered the employ of the Steel Tired Wheel Company, July 5, 1898, going to the Railway Steel Spring Company in 1902, when the Steel Tired Wheel Company was merged with the latter.



N. C. Naylor

He has been employed in the Railway Steel Spring Company continuously since that time.

At the recent annual meeting of the stockholders of the Westinghouse Air Brake Company, the position of chairman of the board was created and filled by the election of H. H. Westinghouse. John F. Miller, formerly first vice-president, was elected to the office of president. A. L. Humphrey, formerly second vice-president and general manager, was made first vice-president and general manager of the company.

Charles A. Rowan, heretofore auditor, was promoted to the position of controller, and John H. Eicher, formerly assistant auditor, was made auditor of the company.

G. H. Peabody, vice-president, and W. A. Austin, consulting engineer, of the Railway & Mine Supply Company, 332 South Michigan avenue, Chicago, have been appointed western representatives of the Southern Locomotive Valve Gear Company, Knoxville, Tenn., and will handle matters pertaining to the Southern valve gear and the Brown power reverse gear in Chicago territory. Mr. Peabody was formerly western sales manager for the Lima Locomotive Works, and Mr. Austin was formerly connected with the Baldwin Locomotive Works, and later chief mechanical engineer of the Lima Locomotive Works.

At a meeting of the board of directors of the American Locomotive Company on December 26, Andrew Fletcher was elected president to succeed Waldo H. Marshall, resigned. Mr. Fletcher has been a director and a member of the executive committee for several years. A successor to J. McNaughton, the vice-president whose resignation has also been accepted to take effect in February, has not been selected. Mr. Fletcher is president of the W. & A. Fletcher Company, manufacturers of marine engines, with a plant in Hoboken, N. J. The corporation is one of the oldest firms of the kind in the country. He is a director of the William Cramp & Sons Ship & Engine Building Company and president of the Consolidated Iron Works and the North River Derrick Company.

George L. Pollock, purchasing agent of the Chicago & Western Indiana and the Belt Railway of Chicago, has resigned to become vice-president and treasurer of the Burnside Steel Company, with headquarters at Chicago, Ill. He was born on December 8, 1874, at Burlington, Iowa, and entered railway service with the Chicago, Burlington & Quincy in May, 1892. From December, 1905, to May, 1906, he was chief clerk to the purchasing agent of the Wabash, with office at St. Louis, Mo., following which he was appointed purchasing agent of the Wheeling & Lake Erie. In May, 1910, he became purchasing agent of the Chicago & Western Indiana and the Belt Railway of Chicago, from which position he has just resigned to become vice-president and treasurer of the Burnside Steel Company, as noted above.



George L. Pollock

At separate meetings of the boards of directors of the two companies on December 8, it was unanimously voted to merge the Westinghouse Air Brake Company and the Union Switch & Signal Company. The matter will be submitted to stockholders of both companies for approval within the next two weeks. It is planned to increase the capital of the Air Brake Company from \$20,000,000 to \$30,000,000, and make an exchange of stock on the basis of four shares of the Air Brake Company for five shares of Union Switch preferred and two shares of Air Brake for three shares of Union Switch common. The object of the merger is to reduce overhead expenses, as both companies are controlled by practically the same interests, and are now engaged in similar kinds of busi-

ness. What changes in the physical status of the plants will result from the merger has not been decided upon.

George H. Groce has left the Electric Storage Battery Company, where he has been a sales agent of the railway department, to become a sales representative in the railroad department of the U. S. Light & Heat Corporation of Niagara Falls, N. Y., with headquarters at 1402 Railway Exchange building, Chicago. Mr. Groce has had considerable railroad experience. Starting as a telegraph operator on the Pittsburgh & Lake Erie in 1880, he has since been with a number of roads in such positions as train dispatcher, signal engineer, division superintendent and assistant to vice-president and to general manager. Mr. Groce has also represented the General Railway Signal Company, and was assistant to the president of that company. From 1912 to 1915 he was vice-president of the Wright Telegraphic Typewriter Company.

R. W. Young, secretary and general manager of the Weir & Craig Manufacturing Company, Chicago, Ill., has resigned to organize and become president of the R. W. Young Manufacturing Company, manufacturer of electric and pneumatic hoists, monorail cranes and electric and pneumatic turntable tractors. Mr. Young was born in Hamilton, Ont., and is a graduate of the Collegiate Institute of that city. In 1892 he went to Chicago to enter the firm of Russell Brothers & Young, iron founders, then being established. This concern carried on business for several years and then sold out, at which time Mr. Young became manager of the Liquid Carbonic Company at Pittsburgh, Pa. In 1902 he returned to Chicago to become secretary and general manager of the Weir & Craig Manufacturing Company.



R. W. Young

A complete reorganization of the Joliet Railway Supply Company, Chicago and Joliet, Ill., has been effected. The entire capital stock, good-will, patents, property, liabilities and assets of the Joliet Railway Supply Company have been purchased by the Northwestern Malleable Iron Company, Milwaukee, Wis. Possession of the offices and plants of the Joliet company has been taken by the new management and new officers elected. The new company's headquarters have been established at 4052 Princeton avenue, Chicago, where extensive additions and improvements to the plant will be made at once. The company will hereafter manufacture its own malleable iron and two new car specialties will be added to the output, which has consisted of brake beams, side and center bearings, etc. The following officers have been elected: President, C. F. Huntoon; vice-president, F. L. Sivyer; secretary and treasurer, W. F. Hoffman; manager, R. F. C. Schultz.

George W. Bender has been appointed assistant to the vice-president of Mudge & Co., with office in Chicago. Mr. Bender, who has been manager of the mechanical department of the same company for several years, was born August 20, 1884, in Pittsburgh, Pa. In 1901 he entered the service of the Pressed Steel Car Company, serving in the engineering department on freight car construction. In 1906 he entered

the service of the American Locomotive Company in the engineering department, where he later had charge of the extra work order department. In 1908 Mr. Bender returned to the Pressed Steel Car Company, again entering the engineering department to engage in passenger car work, remaining until September, 1910, when he resigned to accept the position as chief draftsman of Mudge & Co. Subsequently he was appointed manager of the mechanical department, which position he held up to the time of his recent promotion.

The United Hammer Company, 141 Milk street, Boston, Mass., has purchased the power hammer business of E. & T. Fairbanks & Co., St. Johnsbury, Vt., and is prepared to furnish complete Fairbanks power hammers of all sizes for prompt shipment, as well as parts and repair sections. Fairbanks hammers have been manufactured since 1890; first by the Dupont Manufacturing Company, St. Johnsbury, Vt., who marketed them under the name "Dupont" hammers. In 1902 the business was taken over by E. & T. Fairbanks & Co., St. Johnsbury, who have been manufacturing them since, they giving the machine the name "Fairbanks" hammers, which title will be continued. During the time E. & T. Fairbanks manufactured these hammers they were sold by their selling agents, the Fairbanks Company of New York, and branches, in the East; by Fairbanks, Morse & Co., Chicago, and branches, in the West, and by the Canadian Fairbanks Company in Montreal, and branches, for Canada. They were also handled in Europe by the London, Glasgow, Paris and Hamburg branches of Fairbanks Company. These hammers are known throughout the world, some 1,400 installations having been made.

W. J. Leighty, who has resigned as mechanical engineer of the St. Louis-San Francisco, with office at Springfield, Mo., to become chief engineer for the Oxweld Railroad Service Company, Chicago, Ill., was born at Tonganoxie, Kan., on October 19, 1878. Upon leaving the University of Kansas, where he spent four years, he entered railway service in August, 1904, as a machinist in the Atchison, Topeka & Santa Fe shops at Topeka, Kan. In April, 1905, he was transferred to the efficiency department of the same road, where he remained until the following September, when he re-entered the University of Kansas. In June, 1906, he graduated from the mechanical and electrical engineering departments of that institution, following which he returned to the efficiency department of the Santa Fe at Topeka, Kan. On June 1, 1907, he left the Santa Fe to enter the service of the St. Louis & San Francisco in the office of the general superintendent of motive power, devoting his time to the standardization of mechanical equipment. On December 21, 1907, he became one of the motive power assistants in the experimental and betterment departments on the Atchison, Topeka & Santa Fe, with headquarters at Topeka, Kan., being transferred to the position of assistant to the engineer of tests on August 1, 1912. In October, 1913, he was appointed mechanical engineer of the St. Louis & San Francisco, with headquarters at Springfield, Mo., from which position he resigned to enter the service of the Oxweld Railroad Service Company.



W. J. Leighty

CATALOGUES

POWER HAMMERS.—A booklet recently issued by Beaudry & Company, Inc., illustrates and describes in considerable detail the Beaudry Champion and Beaudry Peerless power hammers made by the company.

LOCOMOTIVE GRATE SHAKER.—Bulletin No. 700, recently issued by the Franklin Railway Supply Company, New York, gives information relative to the advantages and operation of the Franklin steam grate shaker.

LOCOMOTIVE APPLIANCES.—Bulletins No. 111 and No. 112, recently issued by the Economy Devices Corporation, deal respectively with the type B Universal valve chest, and the straightway piston valve arrangement.

CORKBOARD INSULATION.—A booklet and folder recently issued by the Armstrong Cork Company, Pittsburgh, Pa., are entitled respectively "Nonpareil Corkboard Insulation for Cold Storage Rooms" and "Fifteen Years on Brine Lines."

HYDRAULIC VALVES AND FITTINGS.—Catalogue No. 94, recently issued by the Watson-Stillman Company, New York, describes the company's line of hydraulic valves and fittings. The booklet contains 96 well illustrated pages, and in them complete details, sizes and lists are given concerning valves and accessories of all kinds.

ALLOY STEELS.—The Vanadium-Alloys Steel Company, Pittsburgh, Pa., has issued a new pamphlet on Vasco Vanadium, in which information is given as to the study of alloy steels and their uses. The pamphlet also describes the various types of Vasco Vanadium steel, and contains a complete list of carbon steel extras.

KEEPING CARS IN SERVICE.—This is the title of a booklet recently issued by the American Steel Foundries Company to show the advantages to be gained by the application of Economy cast steel draft arms to wooden underframe cars. The booklet contains several illustrations showing the Economy arms and their application.

THAWING OUTFIT.—The Hauck Manufacturing Company, Brooklyn, N. Y., has issued a pamphlet describing its kerosene thawing outfit and torches, and illustrating their use on railroads, for such purposes as the thawing of track work, switches, signaling, hopper cars and the like. Several pages are devoted to detailed descriptions of the several sizes and types of burners made.

SMALL TOOLS.—Catalogue No. 9, recently issued by the Pratt & Whitney Company, Hartford, Conn., is a complete catalogue of the small tools manufactured by the company. The booklet has over 300 pages and gives data and price lists of the company's taps, dies, milling cutters, reamers, punches, drills and miscellaneous tools. About 40 pages are devoted to tables of standard threads, thread dimensions and tap drill sizes, decimal equivalents, etc.

MILLING MACHINES.—Catalogue No. 19, recently issued by the Kearney & Trecker Company, Milwaukee, Wis., is an 86-page booklet describing and illustrating the company's line of milling machines. The Kearney & Trecker Company manufactures milling machines only. In its catalogue it takes up point by point every part of the machines, emphasizing each detail of mechanical correctness and summarizing the advantages of its unique and patented features.

PORTABLE TOOLS.—H. B. Underwood & Co., Philadelphia, Pa., have recently issued a catalogue covering their extensive line of portable tools. The catalogue not only shows illustrations of new tools, but also covers many new

and interesting features which have been added to the older types. The booklet contains much useful information and is of especial interest at this time because of the rapid development which has recently taken place in the design of portable tools, and also because of their increased use in railway shops during the last few years.

GEARS.—Facts About Gears is the title of a 46-page booklet recently issued by the Van Dorn & Dutton Company, Cleveland, Ohio. The booklet is termed a reference book for gear buyers. It is divided into 21 sections giving such information as: Gearing terms, how to order gears of all kinds, spur gear specifications, bevel and mitre gear specifications, worms and worm gears, sprocket specifications, Lewis' rule for strength of gear teeth, diametral pitch formulae, diametral pitch table, circular pitch formulae, circular pitch table, decimal equivalents, metric pitch module, standard keyways, comparative size of gear teeth, etc.

PAINT GUN.—The Spray Engineering Company, Boston, Mass., in Bulletin No. 310 describes the "Spraco" paint gun, a hand tool for use in applying all kinds of liquid coatings. The complete equipment consists of the paint gun proper connected by flexible hose to a portable unit combining in a compact, rugged form the material container, air dryer and strainer, pressure control attachment, and pressure gage. The equipment is adapted for use in shop or field and may be adjusted for spraying the highest grade of varnishes and lacquers, as well as heavy asphaltum and structural paints, producing finely finished surfaces without streaks or brush marks. It is also adapted to applying heavy durable coatings to rough structures.

ENGINE LATHES.—The J. A. Fay & Egan Company, Cincinnati, Ohio, has issued Bulletin No. 201, describing its 18-in. standard engine lathe. This lathe has a double-sliding back gear and is equipped to give 16 spindle speeds, with a single back gear, ranging from 12.5 to 375 r. p. m. and 18 spindle speeds with the double friction back gear ranging from 13.5 to 338 r. p. m. The feed box is provided to give four rates of positive geared feed. The spindle is made of .50 per cent carbon hammered crucible steel, and runs in large phosphor bronze boxes. This lathe has a swing of 18½ in. over the ways and 11¼ in. over the carriage; the bed is 8 ft. long and the distance between centers is 4 ft. 5 in. The net weight of the lathe is 3,200 lb.

AIR COMPRESSORS—PNEUMATIC HAMMERS.—Ingersoll-Rand Company, New York, has recently issued the following bulletins: Form 8,311, on "Little David" pneumatic riveting hammer, inside trigger pattern. These hammers are offered in six sizes, the dimensions and specifications of which are listed in the descriptive table in the catalogue. A very important feature of this tool is the rivet set retainer designed to meet the regulations and requirements of the safety appliance laws enacted in the various states. Form 3,130 on class ER-1 power driven single stage straight line air compressors. These machines are built in various sizes from 6 to 12-in. stroke, with a piston displacement capacity of 52 to 955 cu. ft. per minute, and are equipped with the Ingersoll-Rogler type of air valve. Both catalogues are well illustrated.

PNEUMATIC COLLECTING AND CONVEYING SYSTEMS.—Catalogue No. 235 recently issued by the B. F. Sturtevant Company, Hyde Park, Mass., is devoted to the line of Sturtevant fan systems for collecting dust and conveying materials. The book is 8 in. by 11 in. in size and contains 76 well illustrated pages. It shows the necessity for dust collecting systems and takes up the advantages of Sturtevant apparatus for this work and for conveying pulverized coal and other materials. The fans themselves are described in detail with illustrations of the various types of fans and auxiliary equipment. Information is given which will en-

able the prospective purchaser to ascertain what type and size of apparatus is best suited for his purpose. There are also given tables of velocity, volume pressure, horsepower, etc. A large number of illustrations show actual installations in plants of various kinds.

ELECTRIC RAILWAY APPARATUS.—Recent bulletins from the Westinghouse Electric & Manufacturing Company include the following. Circular No. 1516-A covers electric locomotives for freight haulage. It gives reasons for the adoption of electric locomotives, takes up the handling of freight traffic by electric railways and contains a detailed description of the equipment used in such work as well as the Interstate Commerce Commission requirements for this service. Leaflet 3764-A describes the No. 323-V split frame type railway motor having a rating of 30 kw. at 600 volts. The No. 101-K railway motor with a rating of 30 kw. at 600 volts is described and illustrated in considerable detail in leaflet 3510. This motor is especially adapted to operating conditions requiring the handling of heavy loads at slow speed without undue draft of current on the generating equipments. Circular 1577 takes up standard railway equipments and 1571 drum type controllers. The bulletins are well illustrated.

TAPS AND DIES.—The Greenfield Tap & Die Corporation, Greenfield, Mass., has recently issued catalogue No. 37, containing the entire line of the Greenfield Tap & Die Corporation, and taking the place of the old divisional catalogues as follows: Wells Brothers Company, Division No. 34; Wiley & Russell Manufacturing Company, Division No. 36; A. J. Smart Manufacturing Company, Division No. 3. By combining the tools of the different divisions, the line has been much simplified. The famous old trade marks, "Little Giant," "Lightning," "Green River" and "Smart," are still retained as applies to taps, dies and screw plates, these brand names having reference particularly to the various styles of dies which have so long been marketed under these names. The new G. T. D. trade mark is already making its appearance on some of the tools of the corporation, and will be added to others as fast as practicable. The line illustrated in the new catalogue includes taps, dies, screw plates, reamers, gages, threading machines, tap and die holders, the friction tap chuck, the Wells self-opening die, the new "Gun" tap, pipe threading tools, etc.

INGERSOLL-RAND COMPANY.—This company has recently issued three new bulletins as follows: Form 9,024 deals with steam condensing plants of the Beyer barometric type. The Beyer condenser is of the barometric counter-current type, in which the air and vapor leaving the condenser move counter to or in an opposite direction to the incoming water. As a result, the air contained in the water is removed before the mixture of water and steam takes place, and the air and vapor leave at a comparatively low temperature. The catalogue describes the fundamental principles of steam condensing plants in minute detail, and compares the Beyer barometric condenser with low level jet condensers and surface condensers. Auxiliary apparatus, such as vacuum pumps and centrifugal water pumps, is also illustrated and described in detail. Form 4,122 describes the IR Model Leyner drill sharpener. This bulletin explains and illustrates the sharpener in detail, and shows the various styles of bits. Machine sharpeners, it is asserted, not only make uniform bits, but make them at less expense and with greater satisfaction than can be done by hand. Form 3,033 describes the Imperial "XPV" duplex steam driven compressors, produced to meet a demand for a steam driven air compressor, designed and constructed to operate satisfactorily under "high pressures" and "superheat," as well as under "ordinary steam" conditions. The catalogue shows the various sizes and capacities, and explains in detail the operation of the Imperial piston valve.

Railway Mechanical Engineer

Volume 91

February, 1917

No. 2

We Want to Know

We wish to secure several good articles covering different phases of milling machine practice in railroad shops. For instance, one reader might be able to supply information of special value as to the use of a certain type of milling machine for work which had previously been done on another type of machine at a greater cost or with less satisfactory results. Another contributor might be able to discuss the care and handling of milling machines in order to get the best work from them. Still another might have special information as to the design of the various types of cutters, or possibly of only one type. Still another may have devised jigs or special methods for performing a certain class of work and thereby greatly increasing the output of the machine. These are only a few suggestions. There are a great variety of different problems concerning the advantages and use of milling machines in railroad shop practice, of detail methods of handling the work, and of the design, manufacture and maintenance of the tools, cutters and jigs used in connection with them. In order that we may present a complete study in the form of special contributions to our readers, we shall offer three prizes of \$20 each for the best articles from the practical viewpoint which are received at our office in the Woolworth Building, New York, not later than April 1, 1917.

Valuation in the Mechanical Department

There are a variety of opinions as to how thoroughly the valuation of the railways should be conducted. Some mechanical officers take this matter seriously, while others do not. There is one thing certain, however, and that is unless the mechanical department has sufficiently accurate information and data to support its valuation figures there will be an extended controversy between the road and the federal authorities. No rule of thumb method should be followed. Only absolute and definite facts will stand the test of scientific analysis. The work is being done at a great cost, and but little additional cost will be required to get the information completely and scientifically. Those roads that do not do this are taking a chance. It may result in the acceptance by the government, of an unfairly low valuation, or in the necessity of going over the work again more thoroughly.

From the statement of the law it is apparent that the federal government is after definite information as to the absolute cost and value of the entire railway property. Undoubtedly, in many cases a road's valuation will in the end have to be handled by the railway lawyers. Lawyers are not mechanical men. They will be unable properly to argue their cases without definite and concrete information, nor will they be able to make their arguments good unless they can show how the information was obtained. Every bit of calculation with thorough explanation of the methods followed, should accompany each item valued. The computation should be based on fair and unquestioned premises.

Absolute concrete data is what is needed, and it will be found in the end to be worth considerably more than rule-of-thumb estimating by competent men, however expert they may be.

Analyze Your Engine Failures

The successful man is known to be the one who seldom makes the same mistake twice. This applies equally as well to the successful mechanical department. Needless to say, if it were possible to prevent engine failures recurring from the same causes the locomotives of this country would be in a very high state of efficiency. Regardless of how impossible this may seem, there is much to be done in the reduction of engine failures. If every failure were carefully analyzed and the basic cause of the failure determined, a great deal could be done to eliminate them. One road states that the average cost per engine failure, exclusive of labor and material for repairs, amounts to \$17. Cases have been known where this cost amounted to over \$250, and it was a small failure at that. Adding the cost of labor and material for repairs, the cost per engine failure would be far in excess of the above mentioned average.

The cost is not the only consideration. The reputation of the mechanical department is based very largely on the service it renders. The effect of engine failures is felt throughout the entire operating department, and every means should be taken to reduce them to a minimum. One mechanical department officer has taken special pains to impress upon his men the importance of finding the underlying causes for the engine failures as they occur. Where it is found that they are caused by some inherent defects in the locomotive, strong efforts are made to correct them and the necessary changes are made at the first opportunity. Some roads make as many as 40,000 and 50,000 miles per engine failure, while others average below 10,000 miles. There are, therefore, large opportunities for improvement. It can be done, and it is important that it should be done. Good results can be accomplished only by a very careful analysis of every failure as it occurs, and by making corrections in the design and construction of the equipment to obviate them.

Freight Car Repair Track Earnings

Most railway men do not fully appreciate the opportunity there is for obtaining actual profit from the car repair tracks. An investigation made by a road in the middle West has shown that under normal conditions a net profit of about \$1 per car per day can be made under the M. C. B. prices. This road has taken special efforts to impress this fact upon the repair track foremen. Such profits, however, cannot be realized at the present time on account of the high cost of labor and material, although the 25 per cent increase to the face value of

all car repair bills recently authorized by the executive committee of the Master Car Builders' Association will tend to make some of these tracks profitable. Careful attention should be given to the arrangement of the cars on the track. Cars with light repairs should not be switched in between cars requiring heavy repairs, as time will be lost in getting the car back into service and it will occupy valuable space on the repair track. A few extra minutes used in properly switching the bad orders and classifying them according to the extent of the repairs to be made will be found to be well worth while.

The car repair forces should be well organized and provided with facilities for expediting the work. The repair track should be located convenient to the storehouse and the shops so that as little time as possible will be taken to provide the proper material for the repairs. The yard should have outlets on either end, and where it is composed of more than one track the bad order cars should be classified according to the time it will take to make the repairs. Where it is found necessary to hold a car for shipment of material from owning roads, it will also be found profitable in many cases to remove the car from the repair track, thus allowing another bad order car to take its place. If every car foreman in charge of repair tracks will analyze his particular plant, he will be surprised to see the profit that may be obtained in this work, considering, of course, the service value of the car.

The Cost of Equipment Failures

We all know what trouble is caused the mechanical department by equipment failures, but do we fully appreciate what it costs the railroads in

actual money? Of course it is difficult to determine just what the amount is but the following incident will indicate to some extent what it may be. A through passenger train which was running on a fast schedule was stopped 31 miles from a terminal by an engine failure due to defective reversing gear. The accident was such that the engine could only run in full gear forward. Engines were exchanged with a fast freight train that happened to be in the vicinity and the passenger train proceeded. About five miles from the engine terminal the air supply gave out as the freight engine did not have sufficient compressor capacity. The brakes were bled and the train was taken in under the hand brakes, much to the discomfort of the passengers. A passenger engine was put on at this point and the train proceeded, only to be delayed at the next station by a defective baggage car which had to be replaced and the baggage transferred. This made the total delay to the train about one and one-half hours.

In addition to its through business this train handles a large passenger and mail business from a point about 300 miles from its destination and which is in competitive territory. To save this business and also to relieve the through train from many intermediate stops a special section of six cars was made up at this point and sent out a little late. The total delay of the through train at its final destination was only 15 minutes, and the special section came in a little later. Thus the through passengers and the local passengers from the city above referred to were but little inconvenienced.

This, however, was accomplished at a considerable expense to the railroad. The cost of the special section was in itself a fairly large item, but in addition to this there was the delay to the fast freight train, the delay to the intermediate passengers on the through train, the cost of a baggage car transfer, the extra fuel consumption caused by an additional locomotive and extra fast runs to make up lost time, and wages for overtime to some of the train crews affected.

This was the cost of two equipment failures on the same

train. Others may be more or less expensive while some may even mean loss of life. Is it not well worth while, therefore, to provide a sufficiently large force to properly inspect each piece of equipment?

Locomotive Tractive Effort Formulas

In this issue will be found a discussion of the Kiesel locomotive tractive effort formula by Lawford H. Fry, which is of interest as furnishing a ready method of calculating the tractive effort for any

speed from the principal dimensions of the locomotive. Mr. Fry has departed somewhat from the usual practice and his method should provoke lively discussion on this subject, which is always of interest to designers.

The empirical formula upon which Mr. Fry's method is based was developed from the results of tests of locomotives using saturated steam and its application to engines using superheated steam is open to criticism. There is an inconsistency in basing the value of K on the total heating surface, including the superheater, as there is of course no actual evaporation in the superheater and the effect of the increase in the volume of the steam can be taken care of in the formula. The value of the hourly evaporation per square foot of heating surface K for superheater engines is apparently an arbitrary figure. Using the total heating surface of the superheater engine and changing the value of K compensates for the effect of the elimination of initial condensation and the difference in the rate of heat absorption in the boiler and superheater, which Mr. Fry has assumed to be the same, but the method is hardly logical.

The former practice of calculating tractive effort by applying a speed factor to the rated tractive effort is no longer used when trustworthy data is desired and while Mr. Fry goes a step farther in taking account of some of the numerous factors on which the tractive effort depends, it would seem better in making such calculations to estimate the total evaporation by making use of the data now available concerning the rate of heat absorption in various parts of the boiler, modified to suit the particular case under consideration. The numerous tests which have been conducted on modern locomotives make it possible to estimate the water rate with a fair degree of accuracy and by applying the water rate to the total evaporation, and determining the horse power, the tractive effort can be calculated.

This method is not as easily applied as the formula given by Mr. Fry and the choice between the two systems is a matter in which each designer will use his own judgment. It would be interesting to know the consensus of opinion on this subject and contributions from our readers will be welcomed.

A Neglected Function of the Testing Department

The testing department of a railroad has two principal functions, both of vital importance in promoting efficiency. The first of these, the testing of materials, is so evidently important that a staff of specialists is usually engaged to attend to it and the organization is built up on a permanent basis. The investigation of new methods and the testing of new devices, while no less important, is not so much a matter of routine and unfortunately the work along that line is regulated largely by the financial showing of the railroad. An organization built up with care is often destroyed when drastic retrenchment is demanded. It is for this reason, probably, that so few railroads have adequate facilities and a trained force for testing new devices.

That the matter is of sufficient importance to warrant attention, no one will deny. The amounts which the railroads spend for fuel, oil and supplies make the saving of even a small percentage of the total a matter of great importance. A comparatively slight percentage of saving in operation

justifies an expenditure of large amounts of money and yet, in spite of the enormous sums which the railroads are spending for improvements, their purchases are seldom based on specific knowledge of the performance which can reasonably be expected of the devices purchased. There are certain devices whose efficiency has been demonstrated until it is no longer questioned, but there are many more of questionable merit which are adopted because the arguments advanced in their favor are plausible and no one is in a position to say that they will not do what is claimed for them. An efficient testing department should determine the value of new devices so that they can be adopted at once if they will effect a saving, or definitely rejected if found worthless.

The lack of energy in developing the superheater, even after the economy of superheated steam had been demonstrated, is an instance of the indifference toward new devices manifested by American railroads. The Clench superheater was patented in 1896, the Cole superheater in 1904, and the Schmidt superheater was developed in practically its present form in 1906. At the St. Louis tests in 1904 an engine equipped with a Pielock superheater showed a steam consumption of 16.6 lb. per indicated horsepower hour, while the lowest steam consumption for an engine using saturated steam was 19.4 lb. per indicated horsepower hour. In spite of this demonstration of the marked economy of superheated steam and the feasibility of using a high degree of superheat, there was only one railroad on this continent which took a prominent part in the development of the superheater, and the device was not generally applied in considerable numbers until about 1912.

In purchasing valve gears, how many roads will consider the first cost and the cost of repairs and neglect the more important question of relative coal consumption? So far as we know, no railroad in this country has tested the valve gears now on the market with a view to determining their relative economy, taking all factors into consideration. Certainly the importance of the question would warrant a careful investigation, and this is but one of many problems which should be handled in a broad, thorough way. Each great railroad system should have an organization capable of taking care of all such matters. For the smaller roads it is not feasible and here is the field for a joint experiment station.

The particular form of testing department organization which will give the best results is a matter which each railroad will determine for itself. At present the important thing is to organize the work so that the standards can be established, not on a vague general idea of relative merits, but on a sound basis of the amount which can be saved in dollars and cents.

Car Inspectors Need Better Training

The *Railway Mechanical Engineer* has gone on record many times in recent years concerning the necessity of giving more real attention to the selection and training of car inspectors. Hiram W. Belnap, chief of the Division of Safety of the Interstate Commerce Commission, in a paper before the Central Railway Club, which is abstracted elsewhere in this issue, made a most forceful and able presentation of this subject. While he did not attempt to tell in detail how the situation could be improved, he clearly pointed out facts and made a number of suggestions which, if adopted, would do much to improve conditions. In addition to the car inspector's duties, as outlined in the paper, several more might be added, including a working knowledge of local agreements and the peculiar requirements which exist at many interchange points. What other class of railway employees must fulfill such exacting requirements, or have it within their power to save or waste more money, or to protect or endanger so many lives? Is it not to be wondered at that so little systematic attention

has been given to the selecting and training of these men?

Inasmuch as the greater number of the car inspectors are promoted from freight car repairmen, it would seem that the place to begin is in giving more care to selecting men when they first enter the service and in seeing that they are thoroughly instructed in their duties, as well as in those things which may fit them for promotion to more important positions. With a few notable exceptions, the railroads generally have entirely disregarded the necessity of so doing. Indeed, officers at the heads of the car department who have had many years of practical experience, while admitting the seriousness of the conditions, will insist that a satisfactory apprentice system, similar to that used in the locomotive department, cannot be installed. They will claim that even in the smaller towns it is useless to try to attract the higher grade of boys, because the work of the freight car repairman is classed almost with that of the common laborer. Then, too, it will be argued that these men need to know how to do well only a few jobs or operations and do not need a general training in the work. Difficulty has also been found in keeping the boys to the end of their apprenticeship because of more attractive positions in other fields.

Is there not something wrong with a system which allows such conditions to exist? Industrial managers are beginning to realize that one of the great extravagances of the American industrial system is the continual hiring and firing of men. Steps are being taken by many concerns to remedy this condition. Is it not time that the railroads also awakened to their responsibilities in the matter?

The real executive not only has vision and foresight, but has the ability to impress those above him and make them see in concrete terms the possibilities which lie ahead. Those in charge of the car department cannot very well afford to "pass the buck" and claim that there is inadequate supervision or that the higher officers are not sympathetic. It is their business to impress these higher officers with the necessities of the case and to give adequate attention to the great problems affecting the human element.

Several suggestions were made at the Central Railway Club meeting which will be helpful in the solution of the problem. In order to attract the right kind of men to the car repair department and develop efficient and effective car inspectors it may be necessary to increase the wages, but there are other things of at least as great importance. For instance, they must be made to feel that they are a vital part of the organization. Their positions must be dignified and facilities should be provided which will make their work as convenient and comfortable as possible. Above all they must be given systematic and thorough instruction in their duties and with a view for fitting them for promotion. Truly, it is a big problem, requiring the services of big men, and on its solution depends to a great extent the future welfare of our railways.

NEW BOOKS

Proceedings of the Master Car and Locomotive Painters' Association. 116 pages, 6 in. by 9 in. Published by the association. Albert P. Dane, secretary, Reading, Mass.

This is the report of the forty-seventh annual convention of the Master Car and Locomotive Painters' Association which was held September 12, of this year, at Atlantic City. It contains a report of the test committee, which during the year made a number of tests on heat treated linseed oil and on various paint materials, to find which will offer the greatest resistance to sulphuric acid. Other reports and papers are included in the book concerning the painting of steel passenger car equipment, the treatment of light colored headlinings, proper method of classifying cars for the shop, economy in railroad paint specifications, removing varnish and cleaning cars.

VIRGINIAN TRIPLEX LOCOMOTIVE

Total Weight 844,000 Lb.; Maximum Tractive Effort
166,000 Lb.; Designed for Heavy Pusher Service

A TRIPLE articulated compound locomotive, with 2-8-8-8-4 wheel arrangement, has recently been built by the Baldwin Locomotive Works for the Virginian Railway. As far as the general principles of its design are concerned, this locomotive is similar to the Erie Triple locomotives, which have now been in service a sufficient length of time to demonstrate the value of the type in heavy grade work. The Virginian locomotive exerts a maximum tractive effort of 166,300 lb. and was designed with a height limit of 16 ft. 10 in., and a width limit of 12 ft. at a height of 2 ft. 3 in. above the rail. The center line of the boiler is placed 10 ft. 9 in. above the rail. Flanged tires are used throughout the lateral play between rails and flanges, being $\frac{7}{8}$ in. on the front and back drivers of each group, and $\frac{5}{8}$ in. on the main and intermediate pairs. The locomotive is turned on Y's, on which the curvature is 18 deg.

The boiler is of the wagon top type, with an outside diameter of 100 in. at the third ring. Both the main and auxiliary domes are mounted on this ring, the latter being placed over at 15-in. opening in the shell. The longitudinal seams are all placed on the top center line. That on the dome ring is welded throughout its entire length, while the seams on the first and second rings are welded at the ends. The circumferential seam uniting the second and third rings

The throttle is of the Rushton type, designed to suit the restricted clearance limits. The dome is 10 in. high and 36 in. in diameter; the opening in the shell measures 20 in. longitudinally by 28 in. transversely. The throttle valve is seated immediately over this opening, and on the throttle pipe is cast a supporting bracket which is bolted to the boiler shell. The valve is lifted by a transverse rotating rod, which passes through a stuffing box in the side of the boiler below the dome and has an outside connection with the throttle lever. The latter is placed in a vertical position, and is designed to give maximum leverage and slowest travel of the valve at the beginning of its movement.

The superheater header is of cast iron, in one piece, and is designed for a 65-element superheater having 2,509 sq. ft. of heating surface. The superheated steam pipes leading back to the high pressure cylinders are fitted with slip joints, and the right hand pipe has a connection, through a suitable cast steel elbow, with the Simplex starting valve. This valve is located in the high pressure cylinder saddle.

When working compound the two high-pressure cylinders exhaust into a common chamber, which communicates with the front and back receiver pipes. In starting, the intercepting valve is in such a position that live steam enters both the front and back receiver pipes, as well as the high-

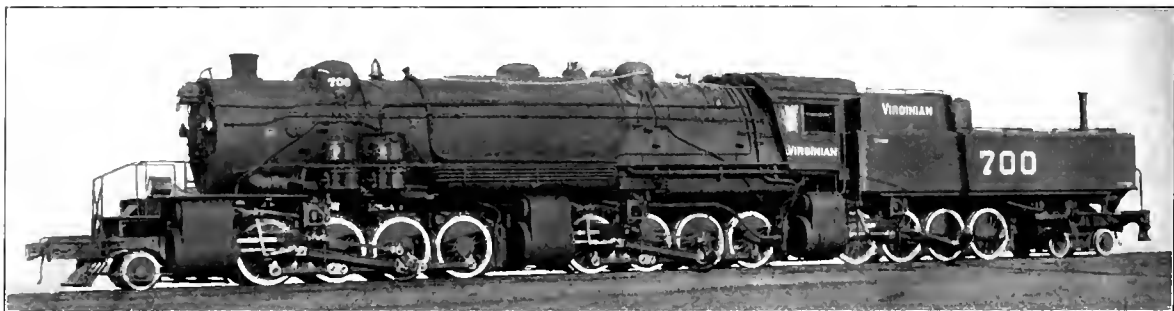

The Virginian Triple Articulated Locomotive

and the seam uniting the third ring with the throat and outside firebox sheets are triple riveted. The back tube sheet is straight, and the tubes have a length of 25 ft.

The furnace is of the Gaines type, fired by a Street stoker, and the arch is supported on five tubes. As the firebox is placed above the middle group of driving wheels, the space available for the throat is exceedingly restricted, and sufficient depth of throat has been obtained by depressing the front bar of the mud ring between the wheels. Flexible bolts stay the throat and back of the firebox and are used in the breakage zones in the sides, while four rows of Baldwin expansion stays support the forward end of the crown. The mud ring is supported on vertical plates at the front and back, and at one intermediate point. Here the load is transferred to the plate through a transverse, cast steel brace, which is strongly ribbed, and supports the longitudinal grate bearers. The ash pan, in spite of the limited space available, has two large hoppers with cast steel bottoms and drop doors. The back receiver pipe and reach rod pass through the pan, a longitudinal duct being provided for this purpose. Provision is made for admitting air at the front of each hopper and near the top of the duct at each side, as well as under the mud ring.

pressure cylinders; the high-pressure exhaust being conveyed to the smokebox through a separate pipe, which terminates in an annular nozzle surrounding the main nozzle. Both the main and auxiliary nozzles have removable thimbles. The intercepting valve is so arranged that, by admitting steam through a pipe connection from the cab, the locomotive can be worked single expansion at any time. When drifting, saturated steam can be admitted to the high-pressure cylinders through a pipe connected with a lever valve in the cab.

The high-pressure cylinder saddle is made in two pieces, the upper of which is riveted to the boiler shell, while the lower is cored out for the intercepting valve and pipe connections. All six cylinders are cast from the same pattern; they are of vanadium iron, so designed that bushings $\frac{3}{4}$ in. thick can be applied subsequently if desired. The pistons have dished heads of forged steel, with cast iron bull rings held in place by electrically welded retaining rings. The piston rods are of Nikrome steel, without extensions. Vanadium cast steel is used for the cross-head bodies; they are of the Laird type, and are as light as is consistent with the strength required. The main crank pins are of Nikrome steel, hollow bored, while the main and side rods and main driving axles are of chrome-vanadium heat treated steel. Vanadium steel

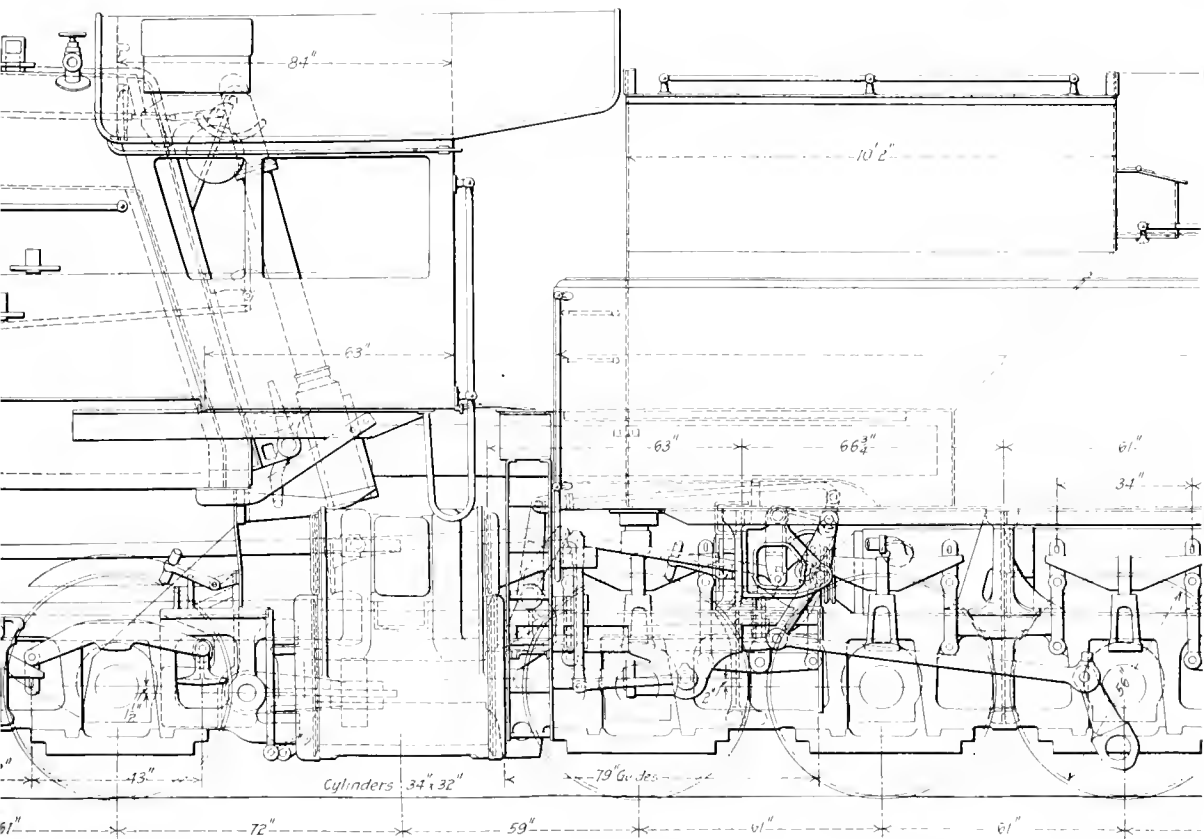
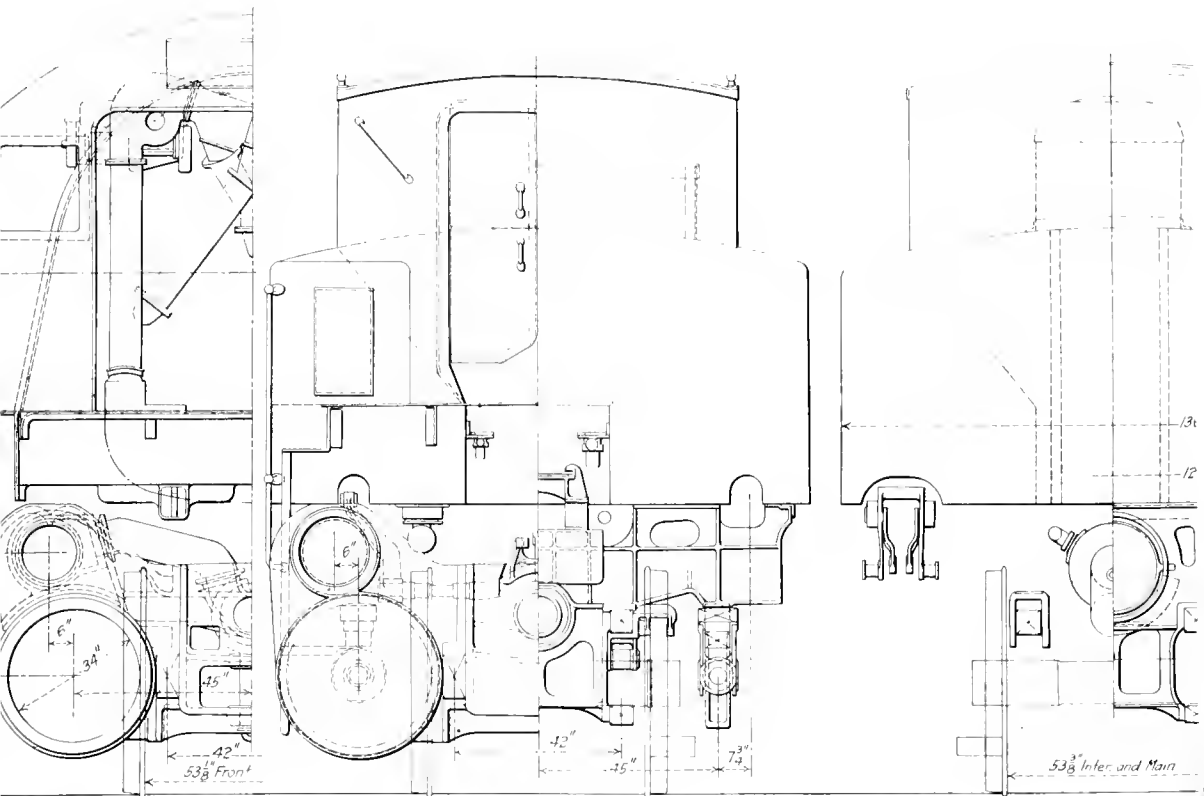

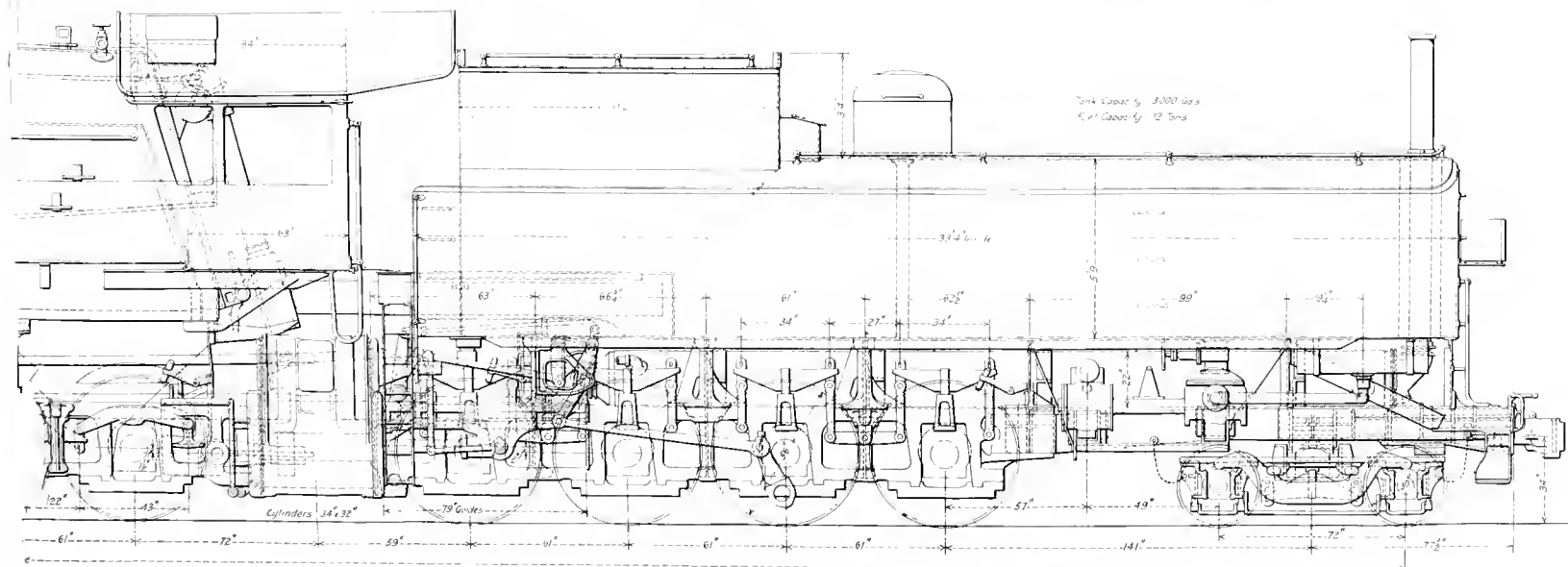
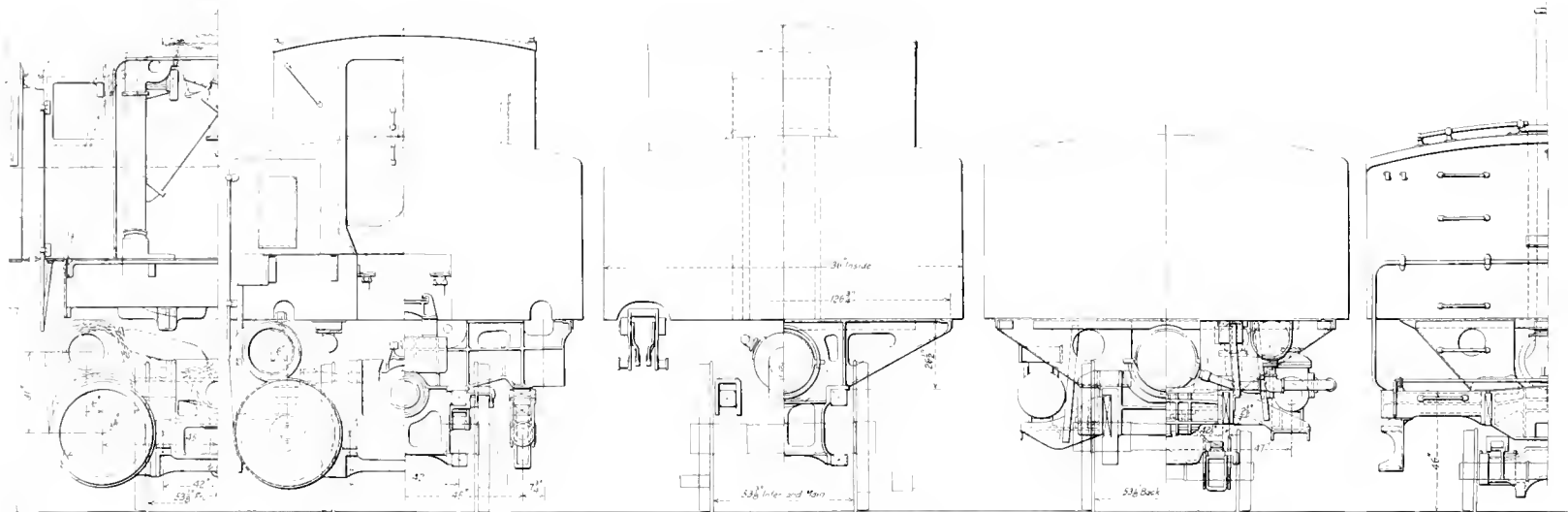

Railway; Total Weight, 844,000 lb.; Tractive Effort, 166,300 lb.



atal Wheel Ba

he Virgini.

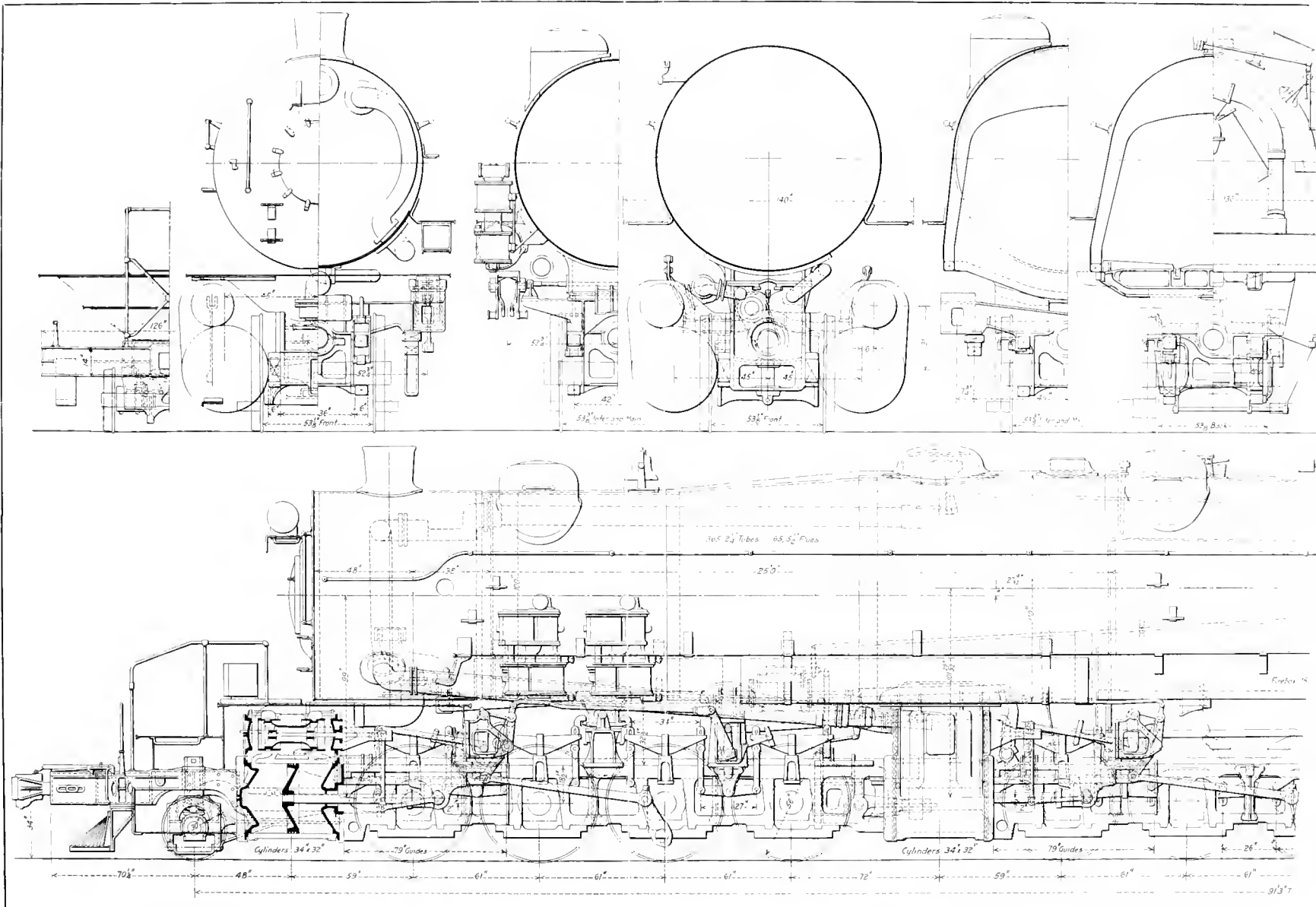

is used for the driving tires and also for the springs. The valve motions are of the Baker type, controlled by the Ragonet power reverse mechanism.

The frames are of vanadium steel castings, 6 in. in width. The radius bars at the two articulated frame connections are attached to horizontal transverse pins, and are fitted with case-hardened spherical bushings which embrace the hinge

9 in. deep inside. It has a capacity of 13,000 gallons. The top is rounded to a radius of 22 ft. 1 in. and the top and side sheets are joined by a plate which is bent to a 3-in. radius. This provides a neat finish, and makes it impossible for water to accumulate on top of the tank. Supports for the tank are provided by the guide bearer of the rear engine by two cast steel bearers placed respectively between the second and third and the third and fourth pair of wheels of the rear groups, and by three bearers composed of 1/2-in. plates, which are placed over the rear frame extensions.

The exhaust steam from the rear cylinders passes through a feed-water heater, which is placed under the tank, and consists of a long drum 22 in. in diameter. The exhaust steam passes through 31 tubes, 2 1/4 in. in diameter, which traverse the drum, 437 sq. ft. of heating surface thus being provided. The feed-water is handled by a Blake and Knowles piston pump, which is placed between the tank and the heater. The pump is located under the tank, back of the rear driving wheels. This arrangement requires a flexible connection in the steam line leading to the pump, but as only cold water is handled, the pump is far more reliable in service than it would be if placed between the heater and the boiler, where hot water would have to be handled. The locomotive is also provided with two injectors for use in cases of emergency.

The tank is of such length that it extends considerably beyond the rear driving wheel base, and the weight of the overhang is carried by a four-wheel, constant resistance engine truck of the Economy type. This truck has a total swing of 13 1/4 in., and the load carried by it is equal to the total weight of an express passenger locomotive of 30 years ago. The two-wheel leading truck is of the Economy type also.

Attention should be called to the sanding arrangements used on this locomotive. There are four sand boxes placed right and left over the boiler, two for the forward group of wheels and two for the middle group. Sand for the rear group is carried in a box, which is placed on top of the tank. The pipes from this box are run to the bottom of the tank through two vertical pipes 4 1/2 in. in diameter. The sanders are of the Graham-White "Perfect" type and are 12 in. number, six for sanding forward and six for sanding backward. In connection with the sanding equipment, rail washers are placed at each end of the locomotive, and a specially designed valve in the cab controls the supply of sand and washing water simultaneously. When the handle of this valve is turned in one direction, sand is delivered under the front drivers of each group and water is discharged through the

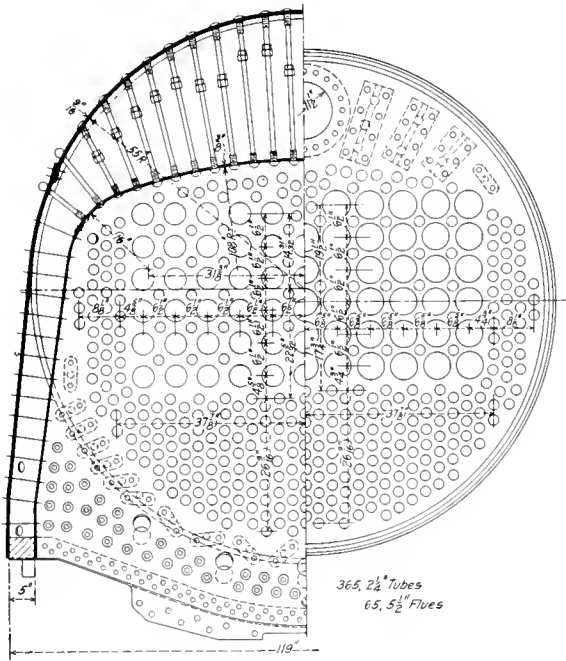

Section Through the Firebox and Elevation of the Front Tube Sheet

pins. This construction provides flexibility in a vertical as well as horizontal plane, and prevents binding at the hinge pins when passing over sudden changes in grade or poorly surfaced track. It has been used by the builders in a number of recent Mallet locomotives. The structural details include a number of steel castings of unusual design. The waist bearers supporting the forward part of the boiler barrel, for

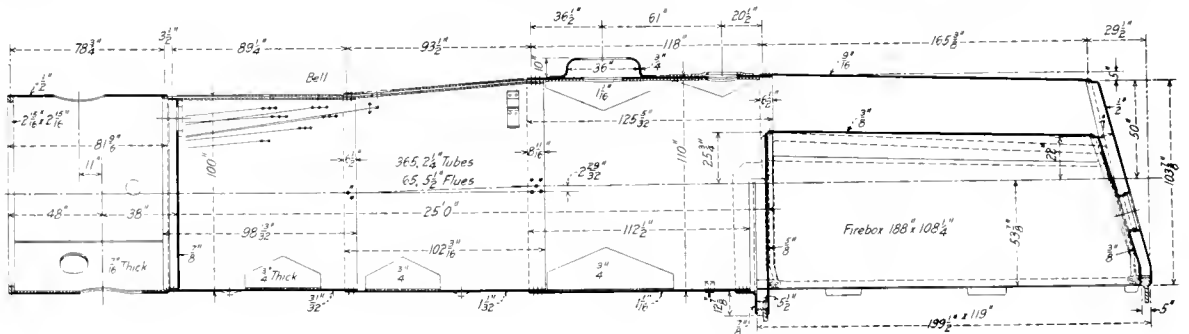

Boiler of the Virginian Triplex Locomotive

example, and the three guide bearers are all bolted to both the upper and lower frame rails, and constitute most effective transverse frame braces. The front bumper beam and deck plate are combined in a large steel casting, furnished by the Commonwealth Steel Company and designed to house the Miner A-59 draft gear. This style of draft gear is also used at the back end.

The tank is 33ft. 4 in. long, 11 ft. 4 in. wide and 5 ft.

washing pipes at the rear; while if the handle is turned in the opposite direction, sand is delivered under the rear drivers of each group and water is discharged through the front washing pipes. Suitable nozzles are also provided for blowing out the sand traps and their pipe connections by means of compressed air. Flange oilers are applied to the front and rear driving wheels in each group.

The cab is roomy and the fittings are conveniently ar-

ranged. The front wall of the cab is sloped to follow the inclination of the back-head, in order to provide ready access to the stay-bolts. The cab equipment includes a pyrometer and a low water alarm. The advantage of a power reverse mechanism in simplifying the arrangement of the cab fittings is most apparent in a locomotive of this size.

Where practicable, the railway company's standard details have been used in this locomotive. The driving tires and driving boxes interchange with those of the Class M-C Mikado type locomotives, which are used in heavy freight service on the low grade sections of the line.

The principal data and dimensions are as follows:

General Data	
Gage	4 ft. 8½ in.
Service	Soft coal
Fuel	166,300 lb.
Tractive effort	844,000 lb.
Weight on working order	726,000 lb.
Weight on leading truck	36,000 lb.
Weight on trailing truck	82,000 lb.
Weight of engine and tender in working order	844,000 lb.
Wheel base, driving	67 ft. 7 in.
Wheel base, rigid	15 ft. 3 in.
Wheel base, total	91 ft. 3 in.
Ratios	
Weight on drivers ÷ tractive effort	4.4
Total weight ÷ tractive effort	5.1
Tractive effort × diam. drivers ÷ equivalent heating surface*	829.3
Equivalent heating surface* ÷ grate area	103.6
Firebox heating surface ÷ equivalent heating surface*, per cent.	3.2
Weight on drivers ÷ equivalent heating surface*	64.8
Total weight ÷ equivalent heating surface*	75.3
Volume both cylinders	46.3 cu. ft.
Equivalent heating surface* ÷ vol. cylinders	242.1
Grate area ÷ vol. cylinders	2.3
Cylinders	
Kind	Compound
Diameter and stroke (s-x)	34 in. by 32 in.
Valves	
Kind	Piston
Diameter	14 in.
Wheels	
Driving, diameter over tires	56 in.
Driving, thickness of tires	3½ in.
Driving journals, diameter and length	11 in. by 13 in.
Engine truck wheels, diameter	30 in.
Engine truck, journals	6½ in. by 14 in.
Trailing truck wheels, diameter	30 in.
Trailing truck journals	6½ in. by 14 in.
Boiler	
Style	Wagon top
Working pressure	215 lb. per sq. in.
Outside diameter of first ring	100 in.
Firebox, length and width	188 in. by 108½ in.
Firebox plates, thickness	sides, back and crown, ½ in.; tube, ⅜ in.
Firebox, water space	front, 5½ in.; sides and back, 5 in.
Tubes, number and outside diameter	365—2½ in.
Tubes and flues, length	65—5½ in.
Tubes and flues, length	25 ft.
Heating surface, tubes and flues	7,689 sq. ft.
Heating surface, firebox	359 sq. ft.
Heating surface, arch tubes	72 sq. ft.
Heating surface, total	8,120 sq. ft.
Superheater heating surface	2,059 sq. ft.
Equivalent heating surface	11,209 sq. ft.
Grate area	108 sq. ft.
Tender	
Water capacity	13,000 gal.
Coal capacity	12 tons

*Equivalent heating surface = total evaporative heating surface + 1.5 times the superheating surface.

A PILOT SNOW PLOW

BY C. C. LEECH

At this season of the year the removal of snow from the right of way becomes a more or less serious problem, depending on the weather conditions and the locality. Drifting of snow frequently takes place where and when least expected. It therefore becomes important that there should be on hand snow plows which can be easily attached to locomotives.

A snow plow of simple construction is shown in the drawings. A 4-in. by 6-in. oak frame is provided on which is laid 1¼-in. oak flooring, and above this is erected a flanger for pushing the snow to each side. This flanger is covered with No. 10 steel and the space between the end of the flanger and the toe of the plow is covered with ¾-in. steel plate. The weight of the plow is carried by two hinge joints

bolted to the pilot, one over each rail and two yokes bolted to the frame of the plow and bearing against the steel plate bolted onto the face of the bumper beam.

It will be noted there is an iron shoe which is bolted on the frame near the toe of the plow. There are two of these shoes, one above each rail, and while the plow is standing

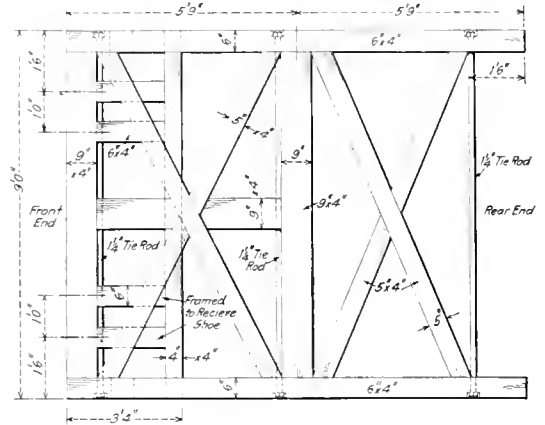

Snow Plow Frame

free without snow on it, there is a small clearance between the shoes and the rails. The clearance is obtained by means of a rod located at the top of the plow and running down through a strap on the bumper beam. In order that the clearance may be correct a stop post is so located that it will work against any convenient part of cylinder or valve casting.

In putting the plow on a locomotive it is not necessary to

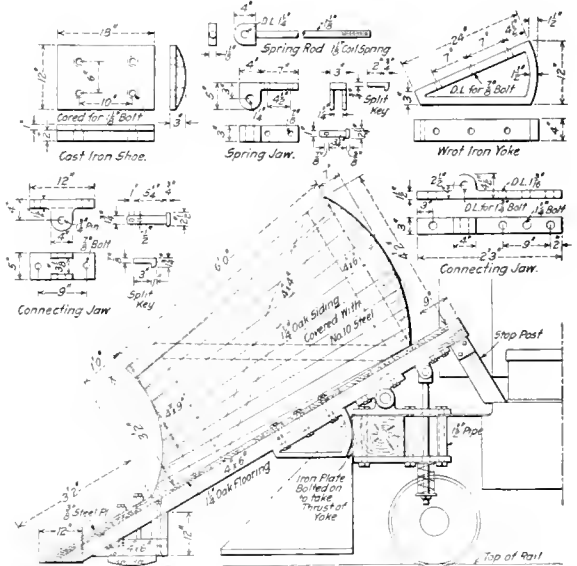

Details and Assembly of Snow Plow

remove the regular pilot as the bearings and yokes are on the outside, over the rails, and do not interfere with the pilot in any way. The front coupler has to be removed, but as it is only held by a pin it can be done in less than a minute.

By keeping the plow on an accessible track during the winter season and having it raised up the proper height by a rail underneath the yoke, it is possible to quickly attach it to a locomotive which has been fitted with hinge joints.

CONVENTION ATTENDANCE A BIG ASSET

Enthusiastic Expressions Received in Prize Letter Competition as to the Practical Benefits Derived

A LARGE number of letters were received in the competition on the Benefits to be Derived from Convention Attendance. Announcement was made in last month's issue of the prize winners. To a man who is closely tied down to the job and has little opportunity of coming in contact with men engaged with similar problems on other roads, the advantages gained from attending a live convention are truly remarkable. Indeed, it is difficult to understand why the officers and foremen on some roads are not more systematically encouraged to attend conventions. The best thing that could be done in the interests of efficiency and economy would be to order them to do so at the company's expense.

THE VALUE OF CONVENTION ATTENDANCE

(FIRST PRIZE.)

BY F. P. ROESCH

Master Mechanic, El Paso & Southwestern, Douglas, Arizona

A man's value to the company employing him in any position, but more especially in an official or semi-official capacity, depends, first, on his own personal knowledge and ability, and, second, on his capacity to use this knowledge or impart it to others. The faculty of imparting information to others is governed largely by ability to think quickly, clearly, and express oneself concisely—to reason from cause to effect, and conversely from effect to cause, to know what is to be said and how to say it understandingly.

Full knowledge of any one particular subject cannot be grasped by any one individual; but many men all studying a single subject from as many angles will naturally cover the ground more thoroughly than can any one man, regardless of the time and attention he may devote to it. That this fact is fully appreciated by manufacturing, engineering and similar concerns, is manifest by the number of experts, consulting engineers, etc., retained on their staffs.

In the railroad field, however, the question arises, How can each man interested in a certain subject obtain the benefit of the research of others devoting their time and energy along similar lines? Surely no better means could be devised than through mutual interchange of ideas and a full discussion of the various phases of the subject.

We are all more or less bound by environment, and often when a new and troublesome question in operation or maintenance arises, we spend time and money seeking a solution, whereas exactly similar cases may have arisen elsewhere, the remedy has been found and the information available for our use, did we but know where to apply for it.

Here we have the keynote of the value of all conventions—the opportunity of obtaining information first hand, covering many vexing problems which daily confront those in charge of various departments on our railways.

The writer has often "been up against it," so to speak, on matters pertaining to locomotive and train operation, maintenance, tests, inspection, etc., and has never yet failed to find help for his troubles at one of the conventions. In fact, the information obtained has been of such benefit individually, that he has not only paid his own expenses, but in some cases his railroad fare, in order to attend. The conventions have been regarded as an annual post graduate course in his line of work.

The question may be asked, Cannot this information be obtained equally as well from the perusal of the printed proceedings? The answer can be given Yankee fashion: Why do physicians and surgeons who are admittedly at the

head of their profession attend clinics and lectures? Books are invaluable where no other means of obtaining information are available, but the most valuable information is obtainable through that intimate personal discussion possible only on the "side lines"—talks that are never published.

Conventions present another educational feature that must not be overlooked, viz., the exhibits. To paraphrase, "An ounce of demonstration is worth a pound of reading." At all present-day conventions can be found modern appliances appertaining to that division of the railroad world under the auspices of which the convention is held, as well as a corps of trained experts to demonstrate and describe their operation. The knowledge so obtainable is in itself alone sufficient to justify attendance, and no one need return home without a full understanding of these devices.

The difference between the man who must remain at home and the one who has the privilege of attending conventions is, the former must frequently grope in the dark to work out his own salvation, while the latter is working in the light of combined and concentrated knowledge gained by the experience of others. Personal experience is a dear teacher. We can learn through the mistakes of others as well as through our own and at much less expense. Is it not therefore good business policy to send men where they can at little cost obtain the benefit of the experience of many men instead of paying for knowledge piecemeal through personal mistakes and personal experience?

BENEFITS DERIVED FROM THE FOUNDRY-MEN'S CONVENTION

(SECOND PRIZE.)

BY R. R. CLARKE

Pittsburgh, Pa.

Conventions are the inventories of progress. They record the advancements of a season. They are great educators. In them we study our composite wants and conditions. We compare notes, exchange opinions, analyze methods and fund the sum total of useful knowledge along specific lines of endeavor.

The American Foundrymen's Association and The American Institute of Metals jointly convened in Cleveland, Ohio, September 11 to 16, 1916. Three features were prominent: practical and technical sessions, plant visitation, and foundry appliances exhibition. The author made this convention a part of his vacation and attended every session. He found it a post-graduate course in experience. Inspiration was in the air. It existed along with an atmosphere of brotherhood, strengthened from association with the best men in the business. The two types of session brought the two types of men close together. Comparison of ideas followed freely; technical men joined in practical discussion lending their basic principles to the elucidation of foundry facts. Similarly, practical men took interest in technical arguments, inquisitive of the practical meaning and application. Technical men expounded in practical terms and details, carrying the thought to its actual foundry application. Better understanding resulted. New ideas sprung forth and old ones took on new features. That was a great benefit. It gave everybody hundreds of little points applicable to daily practice. For instance, in discussing aluminum melting, a technical man stated that aluminum was a carbon absorber. The graphite crucible and the charcoal flux were therefore detrimental. Practical men asked for remedies and got them in detail. Co-ordinating this discussion was a valuable remark from a

man who had obtained 100 aluminum melts from a crucible that had outlived its copper melting usefulness and in which the carbon walls were partially carbon-neutralized.

Papers presented covered the whole field of foundry activity and came from men foremost in the industry. Such subjects as "Twenty-five Years' Experience in a Brass Foundry," "High Pressure Alloys," "Making Thin Walled Castings," "Results of Closer Co-operation Between the Engineer and the Foundry," all from authoritative sources and amplified by free discussion, could not fail to broaden every foundryman present. This whole-hearted co-operation along with the excellent subjects yielded the author his greatest benefit.

Plant visitation consisted in inspection of the representative foundries of the city and afforded the opportunity of seeing how other people do it. Its benefits are too obvious to require comment.

The foundry exhibition afforded a great study. Every related phase was represented, equipment, supply, literature, etc. Life-sized working models, demonstrations, explanations, information, could be seen and had for the asking. We derived invaluable benefit in practice and ideas from the exhibition.

The convention instills within a man a love and appreciation for organization which is a great power. Each "getting together" cements more firmly, and the man attending gets the benefit of the cementing. Maximum benefit from the convention involves a close study of it. The author wrote the Cleveland convention up for a trade paper. He had to study it and sift its proceedings. He realizes full well the results of studying a convention.

Of the many improvements in practice we derived from the convention we submit the following as representative: We presented a paper ourselves on "Gating Non-ferrous Castings." In writing that paper several new ideas came to us. One was that a single gate cut and poured properly would give better results than a half dozen or more combined in running long thin strips. We tried it and were surprised at the high efficiency of the single gate. This single gate weighed about one-tenth as much as the old multiple gate and was much cheaper because of the great loss of high priced metal in melting. We have been using it ever since. We exhibited samples of this gate accomplishment at the convention and other foundrymen present said that they too would discard the multiple in favor of the better and cheaper single gate.

CONVENTIONS—A MIND TONIC

BY E. S. BARNUM*

If you want to be abreast of the times you must make the opportunity to attend some of the mechanical conventions. The young man who has his career ahead of him is the one who can least afford to miss the things that come to him through the attendance of at least one convention each year.

It is a great and only-too-frequent mistake to look at the matter in the light of a great sacrifice of time and money. There's no sacrifice about it. It is the best investment that can be made.

We are in a period of rapid development. A car or locomotive which was adequate a few years ago is now looked upon as antiquated.

What does the future hold?

There is no better way to get an indication of future developments than to attend one of the conventions of the important branches of the mechanical field.

And don't forget that you must be able to work in terms of the future if you would command attention. The past is history and open to all, but the future with great things in

store, is quite another matter. Association with the far-sighted, and an ear close to the ground will certainly help in reading the signs of the times.

Only at a convention are you privileged to hear authorities give their opinions on various subjects of general interest. In many cases you have but to step out to the exhibits and see some actual examples of the subjects discussed. The exhibits at some of the conventions are an education in themselves.

Hearing first handed what the leading lights of the railroad mechanical world have to say on the live subjects is like a tonic to an active mind.

We are very careful to keep our physical condition toned up. The mind should be treated just as fairly. A splendid definition for a real live convention would be "a mind tonic."

WHAT THE AIR BRAKE ASSOCIATION HAS DONE FOR ME

BY W. P. HUNTLEY

General Foreman, Chesapeake & Ohio, Ashland, Ky.

I wish to write on this topic, not for the reason of the prizes offered, but because of the value this association has been to me and to others.

I have been a member of it 19 years, joining at the annual meeting in Nashville in 1897. The association at that time was four years old. It was at a time when air brake information was hard to get. The best and most authentic available descriptive information was contained in what was known as the "little black book" published by the Westinghouse Air Brake Company.

I can remember taking the diagrams and charts that this book contained, and comparing them with the different parts of the brake mechanism. Some of the parts were not clear on the diagrams and in order to trace them out clearly, I found it necessary to blow through the ports or insert several drops of water with an ink dropper and trace the cavities in this way. It was tedious, uphill work, although I can say that the knowledge gained by these methods "stuck."

At the Nashville convention, I was a timid young man, frankly afraid to speak about or on the subjects that were before the convention. I listened, I absorbed, I became interested and enthused. In fact, there was a spirit of earnest interest manifested by all the members and the desire by all to master the details of the troubles, ailments and treatment of the different parts.

In 1898 I was appointed air brake instructor of our company, continuing in the position six years, and was then appointed shop foreman and general foreman at different points on the system. I realized fully what the Air Brake Association was and is to me. From 1897 to the present time, its progress has been great in the way of spreading broadcast knowledge and information that would otherwise be hard to obtain.

It is with a feeling of pride that I note that the Master Mechanics' and Master Car Builders' Associations are recognizing its usefulness as a helpmate to them. The value of the Progressive Questions and Answers is very great, and had the Air Brake Association copyrighted them, its treasury would have been filled to overflowing. But no, it would not do this, stating the information was for the members and the railways the members served. Even when it was clearly evident that other air brake publications were using their "gunpowder," it stuck to its text, believing it best for the common good, for how could the shop repairmen or trainmen be reached otherwise?

I trust to see the day when the Air Brake Association will come fully into its own, when railways will encourage their air brake foremen to attend and join, when railways will purchase copies of the yearly proceedings for the different shops and terminals for the men to read and study, and when the Railroad Y. M. C. A. will carry it as a text book.

* This contribution was entered in the competition, but was not considered in making the awards, Mr. Barnum having associated himself with our editorial staff before the awards were made.

THE KIESEL LOCOMOTIVE TRACTIVE EFFORT FORMULA

BY LAW FORD H. FRY

Prof. A. J. Wood, in his article in the December *Railway Mechanical Engineer*, page 627, does considerable service in putting W. F. Kiesel, Jr.'s, formula on record, but it seems to the writer that the formula offered for the tractive power would have a wider practical usefulness if explained more fully. It also seems that this formula can be more readily handled if brought into a slightly different form. The formula is based on the assumption that at running speeds the relation between the mean effective pressure and the initial pressure in the cylinder is given by the equation:

$$P_m = \frac{2 P_i}{1 + E} \dots \dots \dots (1)$$

where
 P_m = the mean effective pressure in pounds per square inch.
 P_i = the initial pressure in pounds per square inch.
 E = a calculated quantity which Professor Wood calls the ratio of expansion.

This expansion ratio is found by dividing the weight of a cylinder full of steam at the initial pressure by the weight of steam actually passed through a cylinder at each stroke. In terms of volume, which is the way in which expansions are usually figured, this expansion ratio is found by dividing the cylinder volume by the volume which the steam passed through in one stroke would have at the initial pressure. It is worth noting that this expansion ratio is not the same as that usually calculated from an indicator card, because on the card we deal with only the steam present in the cylinder as steam, while in the present case the steam passed through the cylinder includes all of that lost in the cylinder by initial condensation. In the formula the amount of steam passed through the cylinders is determined by the steaming capacity of the boiler. If the locomotive has H sq. ft. of heating surface each foot of which produces K lb. of steam per hour, the total hourly steam production will be HK lb. The volume

of this is $\frac{HK}{W}$ cu. ft., where W is the weight of one cubic foot of steam at the initial cylinder pressure P_i . The volume

of one cylinder is $\frac{d^2 l}{4}$ cu. in., and transforming this into

cubic feet and multiplying by the number of strokes per hour, the total piston displacement per hour is found to be

$$\frac{110}{3} \frac{d^2 l}{D} V \text{ cu. ft.}$$

where
 d = the cylinder diameter in inches.
 l = the piston stroke in inches.
 D = the driving wheel diameter in inches.
 V = the speed in miles per hour.

The expansion ratio is found by dividing the cylinder volume by the volume of steam produced, or in symbols

$$E = \frac{110}{3} \frac{d^2 l}{D} V \times \frac{W}{HK} \dots \dots \dots (2)$$

So far we have followed Professor Wood, merely putting into words what he has given in symbols only, but now a modification of the formula is suggested to bring it into a condensed form, so that in practical work it can be applied with less calculation.

The basis of this is the boiler factor

$$B = \frac{\text{Rated Tractive Effort}}{\text{Total Heating Surface}}$$

The rated tractive effort is calculated from the cylinder dimensions with a mean effective pressure equal to 85 per cent of the boiler pressure, so that

$$B = 0.85 \frac{P d^2 l}{DH} \text{ where}$$

P =the boiler pressure in lb. per sq. in.

Using this to replace the cylinder, driving wheel and heating surface dimensions, equation (2) becomes

$$E = 43 \frac{B V}{K} \times \frac{W}{P} \dots \dots \dots (3)$$

On the right hand side of this equation we have four factors which bring into account various phases of the design and operation of the locomotive.

(1) B , the boiler factor, is dependent on the proportions of the locomotive and its value will depend on whether high speed or low speed is aimed at in the design. It may run from about eight in the case of Atlantic type locomotives to about 15 in the case of Consolidations.

(2) V is the speed at the moment under consideration.

(3) K is the hourly evaporation per sq. ft. of heating surface.* The value will vary somewhat with the design of the locomotive and with the quality of the steam produced. Professor Wood assumes, in the case he calculates, K equal to 10 for a saturated steam locomotive. This is a conservative value, as the Pennsylvania Railroad in the testing plant at Altoona has shown an hourly equivalent evaporation of as high as 18 lb. from and at 212 deg. F. per sq. ft. of heating surface. As this was superheated steam the corresponding actual weight of steam would be about 14 lb. This is a maximum figure and for general practice it would be safe to put

$K = 11$ for saturated steam.
 $K = 10$ for superheated steam.

If a more general statement is preferred we can say that the heat available for evaporation which can be absorbed per hour per sq. ft. of total heating surface may run as high as 17,500 B.t.u., but can be conservatively estimated as 12,500 B.t.u. in general practice. Professor Woods' figure corresponds to about 11,600 B.t.u.

For any given rate of heat absorption the weight of steam produced will depend on the amount of heat required to produce each pound. This is mainly dependent on the amount of superheat to be given to the steam and is only very slightly affected by the pressure at which the steam is produced. For the present purposes the effect of the pressure can be neglected. The following table is drawn up to show the amount of heat required for the production of one pound of steam at various temperatures.

TABLE I.

1 Degrees Deg. F.	2 Heat for the production of 1 lb. of steam from 70 deg. F. B.t.u.	3 Weight of steam produced per sq. ft. of heating surface per hour for various rates of heat absorption.		
		4 For 17,500 B.t.u. per sq. ft.	5 For 12,500 B.t.u. per sq. ft.	6 For 11,300 B.t.u. per sq. ft.
0 (sat.)	1161	15.1	10.8	9.7
50	1193	14.7	10.5	9.5
100	1221	14.3	10.2	9.3
150	1247	14.0	10.0	9.1
200	1272	13.8	9.8	8.9
250	1297	13.5	9.6	8.7

In this table the feed water temperature is assumed to be about 70 deg. F. The three last columns give values for K under various conditions of superheat and of heat absorption or steaming capacity. The figures in column 3 apply to a well designed boiler under conditions of maximum steaming capacity and exceed those which can be maintained in service. Those in column 5 apply to a boiler which is not being pushed to its utmost. Column 4 gives figures which are generally applicable for a conservative calculation. In dealing with modern superheater locomotives the superheat should be taken as about 200 deg.

(4) The fourth factor in equation (3) $\frac{W}{P}$, depends only

* The total heating surface is based on actual dimensions and not on the so-called equivalent heating surface. It includes the fire side of the firebox surface and of the arch tubes, if any, the water side of the boiler flues, and the fire side of the superheater elements.

on the quality and pressure of the steam. Its value for various boiler pressures are shown in column 4 of Table II.

TABLE II.

1	2	3	4
Boiler Pressure. Lb. sq. in.	Degrees of Superheat. Deg. F.	Weight of 1 cu. ft. of steam at initial pressure. Lb. cu. ft.	$\frac{W}{P}$
160	0	0.384	0.00240
	200	0.290	0.00181
170	0	0.405	0.00238
	200	0.305	0.00179
180	0	0.426	0.00236
	200	0.321	0.00178
190	0	0.447	0.00235
	200	0.337	0.00177
200	0	0.468	0.00234
	200	0.351	0.00176

The values of H' are given in column 3. These it must be remembered show, in accordance with the Kiesel formula, the density of the steam at the initial pressure in the cylinder, not at the boiler pressure P . It will be seen that the effect

of the pressure on the values of $\frac{H'}{P}$ is practically negligible.

If we neglect the effect of the pressure and use the mean values as follows:

$$\frac{W}{P} = 0.00236 \text{ for saturated steam.}$$

$$\frac{W}{P} = 0.00178 \text{ for superheated steam.}$$

We can combine these with the values given for K in Table I with the results shown in Table 3.

TABLE III.
Values of $43 \frac{W}{KP}$ for saturated and superheated steam under various conditions of steaming capacity. Steaming capacity is expressed as heat absorption in B.t.u. per hour per sq. ft. of total heating surface.

Degree of superheat. Deg. Fahr.	High steaming capacity 17,500 B.t.u.	Average steaming capacity 12,500 B.t.u.	Low steaming capacity 11,500 B.t.u.
	0	0.0066	0.0092
200	0.0055	0.0077	0.0091

In this table it will be seen that the co-efficient 43 has been combined with the factors H' , P and K , which depend on the quality of the steam, and when this has been done equation (3) for the expansion ratio E can be used in the form given below for calculating the tractive effort for general purposes:

$$E = 0.0092 \text{ B V for saturated steam.}$$

$$E = 0.0077 \text{ B V for superheated steam.}$$

This brings equation (1) for the mean effective pressure into the simple form given below:

$$P_m = \frac{2 P_i}{1 + 0.0092 \text{ B V}} \text{ for saturated steam} \dots\dots\dots (1 A)$$

$$P_m = \frac{2 P_i}{1 + 0.0077 \text{ B V}} \text{ for superheated steam} \dots\dots\dots (1 B)$$

The calculation required in using this in practical work can be still further reduced by eliminating the pressures and getting an expression for the running tractive effort at any speed in terms of the rated tractive effort. To do this we note that P_i is the initial cylinder pressure which Professor Wood gives as 10 lb. per sq. in. less than the boiler pressure. This is based on the Pennsylvania Railroad experiments with 205 lb. per sq. in. boiler pressure, and to simplify matters we may write $P_i = 0.95 P$ where P is the boiler pressure. Then if T_v be the tractive effort at the speed of V miles per hour, and Tr be the rated tractive effort with the assumed mean effective pressure of $0.85 P$, we have T_v is to Tr as P_m , the mean effective pressure at speed, is to $0.85 P$. If this be combined with equations (1A) and (1B) we have:

$$\frac{T_v}{Tr} = \frac{2.24}{1 + 0.0092} \text{ for saturated steam} \dots\dots\dots (1 C)$$

$$\frac{T_v}{Tr} = \frac{2.24}{1 + 0.0077} \text{ for superheated steam} \dots\dots\dots (1 D)$$

The equation in this form can be very readily applied in any given case. The rated tractive effort Tr and the total heating surface H being known, the boiler factor B is found by dividing the first of them by the second, and to find the running tractive effort at any speed it is only necessary to insert this boiler factor and the value for the rated tractive effort together with the speed required, in either equation (1C) or (1D), according as the locomotive uses saturated or superheated steam.

EXHAUST SEPARATOR FOR HEADLIGHT SERVICE

BY L. ERNEST

On engines where the headlight turbine is located in front of the cab on top of the boiler, trouble has been experienced with the condensed steam from the exhaust pipe freezing on top of the cab in cold weather. This has been overcome by the application of a separator, which is shown in the accompanying illustration. It is made of cast iron and contains a baffle plate against which the steam from the tur-

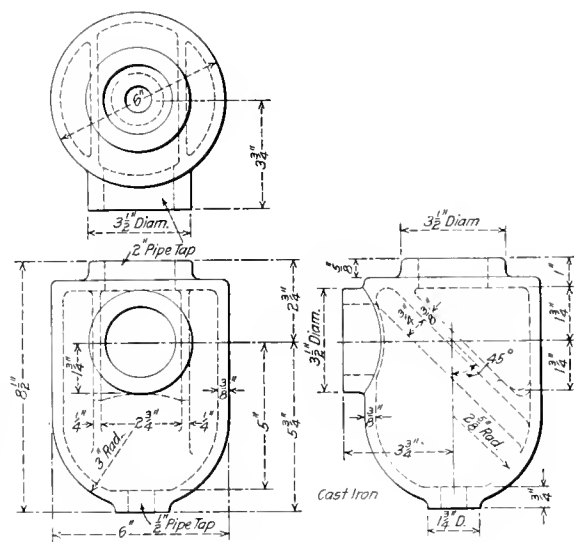

Exhaust Steam Separator for Headlight Service

bine strikes. What moisture is in the steam is caught on this plate and passes out through the opening on the side, while the steam passes up through the small tapped hole at the top. This arrangement has been found to be entirely satisfactory and is of decided advantage where long exhaust pipes are used.

SAFETY STANDARDS FOR CRANES.—It is particularly opportune that at a time when shops are turning their attention toward increased facilities, the American Society of Mechanical Engineers should propose a code of safety standards for cranes. This proposed code, presented before the annual meeting in New York City during December, was drafted by a committee representative of the various interests involved and is for the consideration of the sub-committee on the protection of industrial workers. It covers such details of general construction as the factors of safety, materials of construction, clearance between crane and overhead trusses, buildings, columns or other stationary structures, switch-board wiring and other electrical equipment, and various safety devices. There is also a section devoted to the operation of cranes, containing rules for operators, floormen and repairmen.

WALSCHAERT VALVE GEAR DESIGN

Mathematical Determination of the Proportions of Moving Parts to Meet Locomotive Conditions

By H. A. WEIS

IN the design of a new application of the Walschaert valve gear cut-and-try methods are usually employed to a considerable extent. Where an adjustable model is available it is usually the practice to set this up to meet the conditions imposed by the design of the locomotive, and by trial determine the proportions of the various parts to give the desired valve motion. With the following system a complete layout of a new gear may be worked out in a few hours' time; it involves the use of either analytical or graphic methods in proportioning the moving parts and proceeds directly from one end of the gear to the other, starting with the combination lever. The principle involved is, of course, the same whether the gear is for inside or outside admission valves, but the application is slightly different.

In Fig. 1 is shown the layout of a gear for inside admission valves. As in any method, the first requirement is to

caseing and the cylinder center plus one-half the stroke plus 4 in. Draw a vertical line HH^1 through F , this line being the center line of the combination lever with the crosshead in mid-position and the link block on center.

Proportions of the Combination Lever.—The proportions of the combination lever are determined by the following formula (see Fig. 2), assuming $V = 4$ in.

$$\frac{R}{C} = \frac{L}{V}$$

in which

- R = Crank radius.
- C = Lap + lead.
- L = Length of combination lever.
- V = Distance between radius rod and valve stem connections.

If the combination lever becomes too short, increase V by $\frac{1}{4}$ in.; if it becomes too long, shorten V by $\frac{1}{4}$ in. Lay out

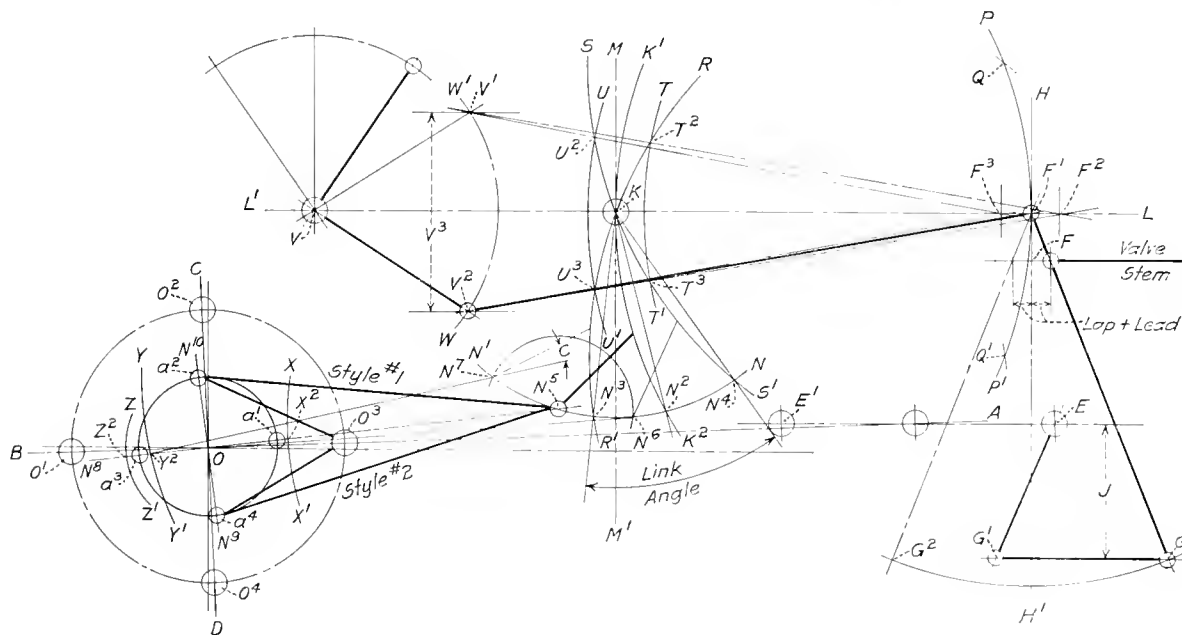

Fig. 1—Layout of Walschaert Valve Gear for Inside Admission Valves

lay out all basic center lines, such as the center lines of the cylinders and driving wheels, and also to locate all limiting points fixed by the boiler, frames, cylinder heads, casings, guides and guide yokes. For the greatest convenience a scale of three inches to the foot should be used. Draw a line AB through the center of the crosshead in mid-position and the center of the main driving wheel, O . Next draw a line, CD , at right angles to AB through O ; with O as a center and a radius equal to one-half the stroke draw the crank circle, cutting lines AB and CD at the points O^1 , O^2 , O^3 and O^4 . Points O^1 and O^3 are the correct dead centers and the other two points are the quarter positions of the main crank pin. With a radius equal to the main rod length and O^1 and O^3 as centers, cut the crosshead path at E and E^1 , these points being the position of the crosshead at the dead centers. **Locate** point F to the left of the vertical center line of the cylinder by an amount equal to the distance between the cylinder head

the combination lever on the drawing as shown in Fig. 1, point F and line HH^1 determining its location.

If the design is for an outside admission valve a combination lever of the type shown in Fig. 2A is required. The same formula is used with the exception that

$$L = \text{Length of combination lever} - V.$$

Union Link and Crosshead Arm.—The extreme positions of the lower end of the combination lever are shown at G and G^2 . In these positions the union link should be horizontal. First determine J , the distance between the center line of the crosshead and the union link connection, as follows (see Fig. 3):

$$J = \sqrt{L^2 - R^2} - (E + V)$$

in which

- E = Vertical distance between steam chest and cylinder centers.

For inside admission valves, if J should become less than

12½ in. lengthen the combination lever; if more than 16 in. shorten the combination lever. For outside admission valves *J* should not be less than 14 in. nor greater than 18 in.

The length of the union link may then be determined by the following formula:

$$C = \sqrt{A^2 + B^2}$$

in which

- C = Length of union link.
- A = Distance between crosshead arm connection and center line of combination lever in mid-position.
- B = Vertical distance between crosshead arm connection and the lower end of the combination lever (= L - V - E - J).

Assume *A* as about 20 in. If this brings point *G*¹ more than 10 in. either side of the crosshead center make *A* shorter and recalculate the length of the union link. This should not be more than 22 in. nor less than 15 in.

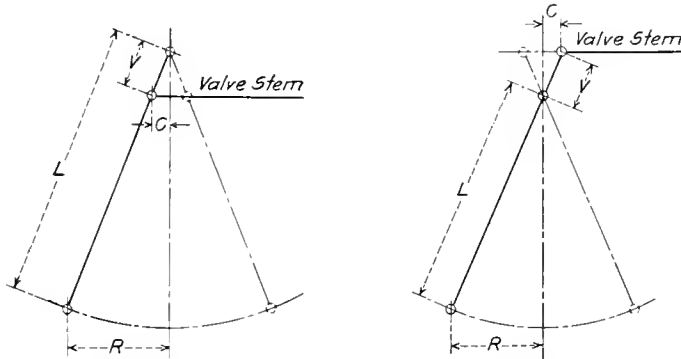

Fig. 2

Fig. 2A

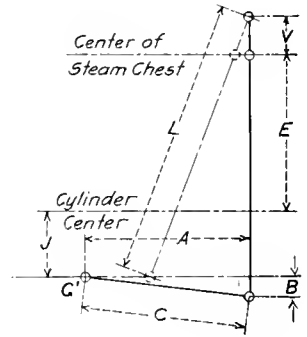

Fig. 3

Fig. 2—Combination Lever for Inside Admission Valves. Fig. 2A—Combination Lever for Outside Admission Valves. Fig. 3—Length of Crosshead Arm and Union Link

Valve Travel.—In ordinary cases the valve travel equals twice the lap plus twice the port opening. However, this does not give sufficient valve travel for the cut-offs desired on locomotives; a valve travel is to be used which gives about 88 per cent to 90 per cent cut-off, which is necessary to start a heavy train. Construct a valve diagram as shown in Fig. 4, finding the valve travel for the desired cut-off. Referring to the diagram:

- AB = Valve travel.
- AK = Lead.
- OL = Lap.
- OG = Exhaust lap, if used.
- LP = GH = Width of steam port.
- OS = Crank position when valve opens.
- OC = Crank position at cut-off.
- Z = Crank angle at maximum valve travel.

The width of port opening for any desired position of the crank is the distance measured radially from center *O* between the lap circle *OL* and the valve circle *OUPW*, the maximum opening being maintained from *F* to *H*. The width of port opening, during exhaust is similarly indicated by the shaded portion *G X H Y*.

When laying out valve diagram assume about 6 in. valve travel. If cut-off is less than 88 per cent increase the valve travel by ¼ in. With the assumed valve travel and the lap and lead known, draw *SC* tangent to the lap and lead circles. If exhaust lap is used draw *ED* parallel to *SC* and tangent to the exhaust lap circle. If the exhaust is line and line draw *NM* through *O* parallel to *SC*. Draw *CR* perpendicular to *AB*. Then the

$$\text{Per cent maximum cut-off} = \frac{AR}{AB} \times 100.$$

The valve travel is obtained from the link and crosshead movements combined, and its amount has a direct effect on the amount of movement which must be obtained from point *F*¹, Fig. 1. In Fig. 5 is shown a graphical solution of the movement of *F*¹ for inside admission valves. This is de-

termined as follows: Lay off *OD* equal to *R*, the crank radius. With *O* as a center and a radius equal to *A*, one-half the valve travel, draw a semicircle, as shown by the full line. Draw *EF* perpendicular to *OD* through *O* and lay off the distance *C*, equal to the lap plus the lead, to the left of *O*. Erect a perpendicular at *H* cutting the valve circle at *G* and draw line *DG*, cutting line *EF* at *K*. The distance *OK* is equal to *B*, one-half the required travel of point *F*¹, Fig. 1. Stated as a formula which may be applied without the use of the drawing board,

$$B = \frac{R \sqrt{A^2 - C^2}}{R - C}$$

For outside admission valves the graphic solution is shown in Fig. 5A. This differs from the Fig. 5, in that *OH* is laid

out to the right instead of to the left of *O*. The formula then becomes

$$B = \frac{R \sqrt{A^2 - C^2}}{R + C}$$

Link and Link Angle.—The rise of the link block should

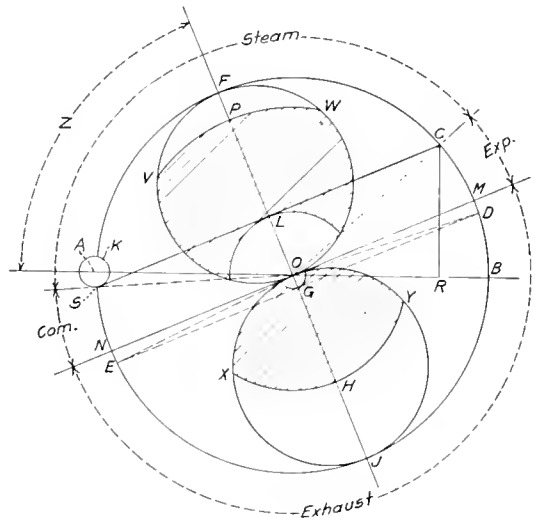

Fig. 4—Valve Diagram

be made about 9 in., which is common practice, but can be increased to 9½ in., maximum, beyond which the link angle becomes too great. Having found the travel of point *F*¹

(Fig. 1), find the link angle as shown in Fig. 6, in which

- D = 1/2 link angle.
- K = Travel of F¹ (Fig. 1) = 2 × B (Fig. 5).
- Y = Lift or drop of the link block.
- S = Y + 3 in. = link clearance.

The following relations will readily be seen to exist:

$$X = \frac{.5 K}{\tan D} \text{ and } Y = \frac{.5 K}{\sin D}$$

The link angle ordinarily should not be greater than 45 deg., while the lift of the link block is usually about 9 in. for inside admission valves and 8 in. for outside admission valves. In laying out a new gear solve for X or Y first, assuming a link angle of 45 deg. Should the required valve travel be unusually large, the link angle may be increased to

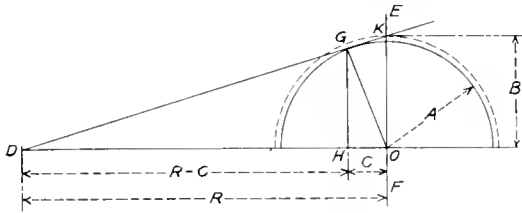

Fig. 5—Travel of F¹, Fig. 1, for Inside Admission Valves

a maximum of 50 deg., and the link block lift increased to 9 1/2 in. These limits should never be exceeded. When a case of this kind presents itself, first increase the link block lift to 9 1/2 in. and determine the link angle. Should the latter exceed 50 deg. it will be necessary to decrease the valve travel by an amount necessary to keep the link angle within the above limit.

Having found the link angle, locate the link center K, Fig. 1, about halfway between the vertical center line of the main wheel and the vertical line through point F, Fig. 1, on line LL', passing through point F' and parallel to the horizontal center line of drivers. Since point F' may be rather high on engines having cylinders of large diameter and inside admission valves, or may be low where outside admission valves are used, point K may be located either

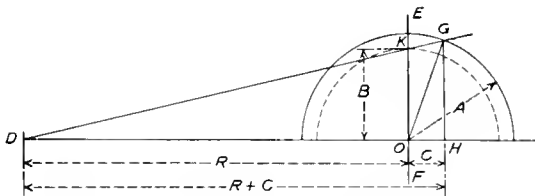

Fig. 5A—Travel of F¹ for Outside Admission Valves

lower or higher than point F', as the case may be. This will not affect the gear seriously, provided the drop or rise of the line F'K from the horizontal does not exceed 1 in 12.

Draw a line MM' through K at right angles to LL', the center line of the radius bar. Line MM' is the center line of the link and, in all cases, must be at right angles to LL'. With K as a center and a radius equal to the link foot radius (the vertical distance between the link center and the horizontal wheel center minus 3 in.) draw an arc NN'. With a radius equal to F'K (the length of the radius bar) and F' as a center, draw arc K'K', cutting NN' at N'. With K as a center and the same radius draw PP', through point F'. Draw a line through K N' and on this line as a center lay off the link angle N'K N'. With N' as a center and a radius equal to F'K cut arc PP' at Q'; with the same radius and N' as a center cut arc PP' at Q. With the same radius and Q Q' as centers, draw arcs RR' and SS', these arcs being the center lines of the link in its extreme positions. Lay off

distance B (Fig. 5), each side of F', locating points F² and F³. With a radius equal to F'K and F² F³ as centers, draw arcs T² T³ and U² U³, cutting the center lines of the link in its extreme positions at points T² T³ and U² U³. These points locate the center of the link block in extreme positions for both forward and reverse motions.

Radius Bar Suspension.—Various forms of radius bar suspensions are used in practice, the two principal types being shown in Fig. 1 and Fig. 8, respectively. In laying out the suspension shown in Fig. 1, locate point F' about 31 in. to the left of K on line LL'. This distance will provide the proper clearance for the radius bar and radius bar lifter. With a radius of 19 in. (the maximum length of reverse shaft

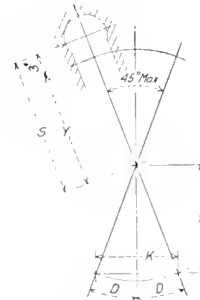

Fig. 6—Length and Angle of the Link

arm when distance K I' = 31 in.) and I' as a center, draw arc II' II', this line being the path of the radius bar lifter. Draw lines through points F² T², F² T³ and F³ U², F³ U³, cutting arc II' II' at I¹ and I². If the two lines do not in each case cut line II' II' at a common point, place points I¹ and I² half way between the actual points of intersection at top and bottom respectively. Distance I¹ I² between the two points just found is the throw of the reverse shaft radius

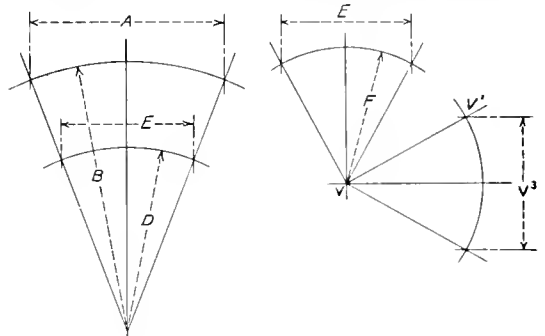

Fig. 7—Proportions of the Reverse Lever and Reverse Shaft Arm

bar connection. Proportion the reach rod arm by the formula (Fig. 7)

$$\frac{E}{F} = \frac{V^2}{V V^3}$$

in which I¹ I² and I³ are known and

- E = Throw of reach rod arm.
- F = Length of reverse shaft reach rod arm.

The proportion of the reverse lever must be such that

$$\frac{A}{B} = \frac{E}{D}$$

E depending on the length of F above, and

- A = Throw of the reverse lever at the quadrant.
- B = Radius of the quadrant.
- D = Radius of the reach-rod connection.

In Fig. 8 the radius bar is shown suspended by a link from the reverse shaft arm, the center of the shaft being lo-

cated forward of the suspension. In laying out this type of suspension draw arcs F^1V^1 and I^2I^3 (see Fig. 8) with a radius equal to F^1K plus 9 in. and with points F^2 and F^3 as centers. Draw lines through points F^2T^2 and F^2T^3 , cutting arc I^1I^1 at points W^1 and W^2 ; also draw lines through F^3U^2 and F^3U^3 , cutting arc V^2V^3 at W^1 and W^3 . With a radius of 12 in. (the length of the suspension link) and

N^2N^3 as a radius, locate points N^6 and N^7 , which are the extreme positions of the link foot.

The above procedure is based on the assumption that the line LL^1 (Fig. 1), is parallel to the center line of the drivers. If the link center should be located below this line, proceed as indicated by the broken lines in Fig. 9. In this case DE is horizontal and DE^1 represents the slope of the line through F^1 and K (Fig. 1). Arc HJ is drawn from E as a center with a radius A equal to the link foot radius plus M . With this difference in the value of A the formula is applied in the same way as before.

Eccentric Rod.—Draw line N^5N^8 through the center of the crank circle, O , in Fig. 1, and draw line N^9N^{10} at right angles to this line through O . With N^6 as a center, and a radius equal to N^5O , draw an arc XX^1 , cutting line N^5N^8 at X^2 . With the same radius and N^7 as center draw arc I^1I^1 , cutting line N^5N^8 at I^2 . With O as a center and a

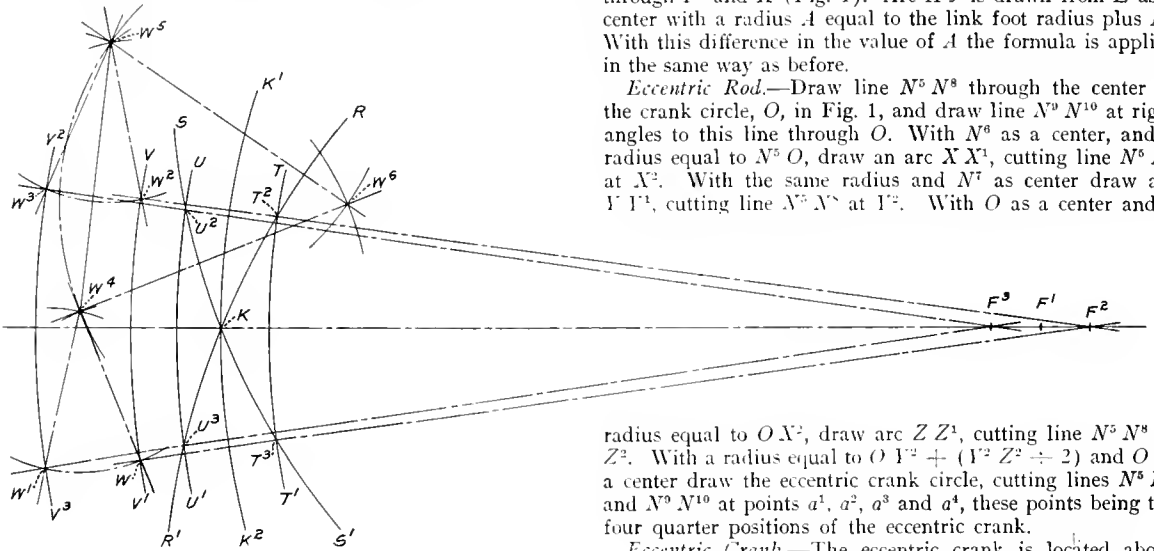

Fig. 8—Link Suspension of the Radius Bar.

W^1 , W^3 , W^2 and W^3 as centers, strike arcs, the intersections of which locate the points W^4 and W^5 . With a radius of 21 in. and W^4 and W^5 as centers, locate point W^6 , the center of the reverse shaft. Proportion the reverse shaft reach rod connection as shown in Fig. 7, using distances W^4W^5 and W^5W^6 as the known quantities.

Link Foot Offset.—In Fig. 9 is shown the graphical solution of the link foot offset. This is laid out on the horizontal line DE , the length of which is equal to the length of the radius bar. Draw FG perpendicular to DE through E and

radius equal to OX^2 , draw arc ZZ^1 , cutting line N^5N^8 at Z^2 . With a radius equal to $OY^2 + (Y^2Z^2 \div 2)$ and O as a center draw the eccentric crank circle, cutting lines N^5N^8 and N^9N^{10} at points a^1 , a^2 , a^3 and a^4 , these points being the four quarter positions of the eccentric crank.

Eccentric Crank.—The eccentric crank is located above

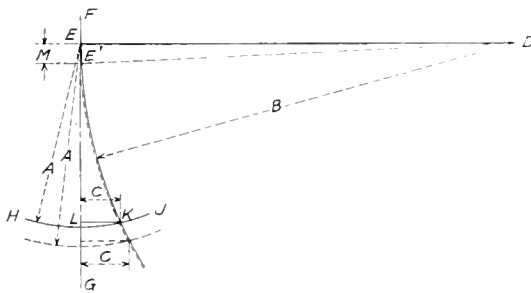

Fig. 9—Link Foot Offset

with this point as a center strike the arc HJ , using the link foot radius. With D as a center and a radius equal to the length of the radius bar draw an arc intersecting HJ at K . Then KL equals the amount of the link foot offset. If

- A = Link foot radius
- B = Length of the radius bar
- C = Link foot offset

the above relation may be expressed by the formula

$$C = \frac{A^2}{2B}$$

Lay off the distance C to the left of line MM^1 (Fig. 1), locating point N^5 on arc N^5N^7 . With N^5 as a center and

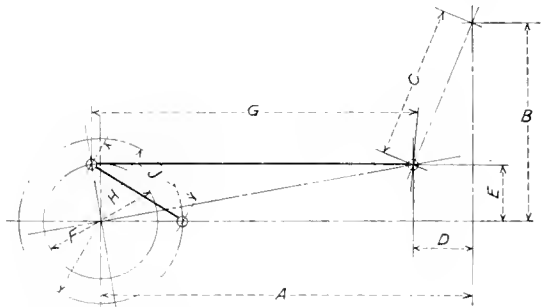

Fig. 10—Lengths of Eccentric Rod and Crank; the Latter Trailing

center O , the crank pin being on the forward dead center, when the reach rod connects above point I^1 , Fig. 1, and below point W^6 , Fig. 8, (see style 1, Fig. 1). It is located below

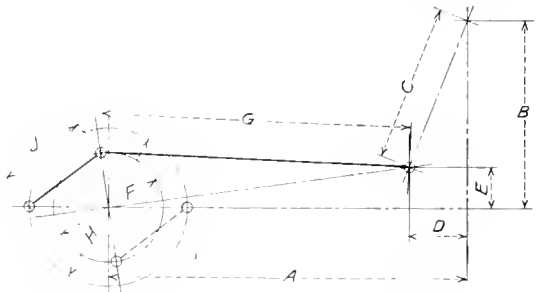

Fig. 10A—Lengths of Eccentric Rod and Crank; the Latter Leading

center O when the reach rod connects below point V and above point W^6 (see style 2, Fig. 1).

For outside admission valves the positions are reversed.

Draw a line through O^3 and a^2 or O^3 and a^1 , as the case may be, this line being the center line of the eccentric crank.

The length of the eccentric rod and crank may be scaled from the drawing, or they may be calculated, Fig. 10 showing the geometrical relations on which the calculations for Style 1, Fig. 1, are based. If

- A = Horizontal distance between main wheel and link centers
- B = Vertical distance between wheel and link centers
- C = Link foot radius
- D = Link foot offset
- E = Distance from the center line of the drivers to the link foot connection (link in central position)
- F = Diameter of eccentric crank circle
- G = Length of eccentric rod
- H = Diameter of the crank pin circle
- J = Length of the eccentric crank

the length of the eccentric rod is

$$G = \sqrt{(A - D)^2 + E^2 + \frac{1}{2} F^2}$$

The distance from the wheel center line to the link foot connection is

$$E = B - \sqrt{C^2 - D^2}$$

The length of the eccentric crank is

$$J = \sqrt{\frac{1}{2} H^2 + \frac{1}{2} F^2} + \frac{E}{\frac{1}{2} F (A - D)}$$

The length of the eccentric rod is correct when $a^1 N^6 = a^2 N^7 = a^2 N^5 = a^4 N^5$.

For Style 2, Fig. 1, the length of the eccentric rod remains unchanged, as may be seen by referring to Fig. 10A. The length of the eccentric crank, however, is shortened, its value being

$$J = \sqrt{\frac{1}{2} H^2 + \frac{1}{2} F^2} - \frac{E}{\frac{1}{2} F (A - D)}$$

Care should be taken that the eccentric rod does not form an angle less than 10 deg. at C in position $a^2 N^7$ (Fig. 1). If this angle should be smaller, the link foot offset can be slightly reduced without affecting the gear seriously. If this becomes necessary the length of the eccentric rod and crank must be recalculated.

MECHANICAL DESIGN OF ELECTRIC LOCOMOTIVES

A paper on this subject was presented by A. F. Batchelder before the railroad section of the A. S. M. E. at the annual meeting in New York. An abstract was published on page 558 of the November, 1916, issue.

DISCUSSION

C. H. Quereau, superintendent electrical equipment, New York Central—The operating advantages gained by having electric locomotives designed to operate in either direction are of such great importance that means must be found to provide satisfactory designs to meet this condition. The chief difficulty with present double end locomotives is the oscillation of the trailing truck which Mr. Batchelder proposes to prevent by the introduction of resistance against swivelling. This scheme is practical and has been so demonstrated, but it results in increased flange wear, at least when the center of gravity is low.

I am particularly interested in that the item of "reliability in service" has been given an important place in the list of requirements for electric locomotives. This is a feature which quite commonly is omitted in a discussion of this kind. On railroads which run through a sparsely settled country with comparatively few trains per day, a train delay of half an hour may be of comparatively little importance, but in eastern territories, especially around the large cities, a delay of a few minutes will upset the smooth operation of the railroad for hours and the effect of it will reach back on the line for 150 miles. It is my opinion that the prevention of such delays justifies a considerable increase in first cost, and also that such maintenance methods should be employed

that will prevent, as far as possible, delays to traffic. It is decidedly poor policy to reduce maintenance costs if by so doing the result is increased traffic delays.

In my judgment Mr. Batchelder very wisely considers the "cost of maintenance of permanent way" of more importance than "cost of maintenance of locomotives." I believe, however, that if the cost of maintenance of way is no greater under electric than steam operation, it would be satisfactory and would not be used as an argument against electrification.

As to the cost of maintenance of electric locomotives: The difference in the cost of maintenance at the rate of 3.5 cents a mile and 7 cents a mile is approximately \$1,000 per engine per year. This saving, capitalized, represents a considerable sum, and would warrant an appreciable increase in first cost. The sum mentioned is 10 per cent of \$10,000, or 5 per cent of \$20,000.

With half a dozen different designs of electric locomotives, no one has had the advantage of experience with more than one of these types. Therefore, one's conclusions as to other types are based on opinions and theoretical considerations rather than actual results as shown by service records.

The New York Central electric locomotives are all equipped with bipolar, gearless motors mounted directly on the driving axle. The operating results have been completely satisfactory to the officers of every operating department affected. This statement, you will note, does not include the net financial returns from the investment, which must take into account the item of fixed charges.

With the usual maintenance these locomotives ride satisfactorily, do not have any undue effect on the track structure, and are perceptibly more comfortable than steam locomotives. In order to secure these results it is necessary to keep the total lateral motion, both in the boxes and center-pins, within limits which approximate three-quarters of the allowable lateral motion on steam locomotives.

Table I contains statistics which will permit a conclusion as to the reliability of these locomotives in service, and which will probably be more satisfactory than any general statement or expression of opinion, no matter how authoritative.

TABLE I.

Year	Miles Per Detention—All Locomotives			
	Mechanical	Electrical	Grand Total	
1912	48,271	103,967	32,965	
1913	27,873	86,716	21,093	
1914	35,625	57,395	21,981	
1915	53,720	107,440	35,813	
1915	Type "S" Locomotives (Rigid Frame)	59,583	187,260	45,201

Note: All detentions of two minutes or more included. In 1913 and 1914 there was a total of 16 Class "T" locomotives placed in service. In 1912 there were 47 locomotives in service. Since the middle of 1914 there have been 63. Detentions due to man failures, or delays to following trains, not included.

In this connection I wish to enter a strong plea for the use of "miles per detention," instead of "miles per minute detention," as the unit in the preparation of statistics by which to judge the reliability of equipment in the service and the efficiency of the organization responsible for maintaining it. Including the time element leads only to confusion and is, therefore, worse than useless.

TABLE II.

Year	Cost, Cents Per Mile		
	Labor	Material	Total
1912	1,888	1,460	3,348
1913	1,982	1,454	3,436
1914	2,155	2,134	4,289
1915	1,901	1,379	3,280

Note: The above statistics were compiled in accordance with the requirements of the Interstate Commerce Commission. In the year 1914 it was necessary to replace all driving wheel tires because of unsuitable material, regardless of the extent to which they had been worn. The costs of maintenance have been essentially as above since 1907, omitting 1914.

In studying Table II, the following facts should be borne in mind. These figures include the cost of inspection and

maintenance of all the electric locomotives, both road and switch. In 1912 and 1913 approximately half the total engine mileage and in 1914 and 1915 approximately one-third was that of engines used in switching service. Our experience has shown the cost of maintenance of engines in switching service to be about twice that of those used exclusively in road service. It follows that the cost of maintaining the road locomotives has been about 2.5 cents per mile and that of the switch engines about 4.8 cents per mile. In this connection it is only fair to call attention to the fact that these engines were not designed for switching service. Bearing this in mind, it will be seen they have given remarkable results.

For the first ten months of 1916 the average cost of maintenance of all the electric locomotives has been 2.73 cents per mile. This gives a cost of approximately 4 cents per mile for the locomotives in switching service and approximately 2 cents per mile for those in road service. I expect these costs will not be exceeded for the entire year 1916, but very much doubt that we will be able permanently to keep the maintenance costs at this level.

C. E. Eveleth (Baldwin Locomotive Works)—When an occasion arises to examine critically different designs of electric locomotives there is almost always a tendency, due to the individual's interest in specific features, to concentrate on particular elements and rather superficially consider the locomotive as a whole, but in Mr. Batchelder's paper we are fortunate in having a clearly brought out presentation of all the essential elements. A number of the elements are intimately related to common features of design, particularly the subject of "service time factor" and "reliability in service" of locomotives which are all affected directly by the simplicity of parts.

Disregarding other features, the bipolar type of locomotive with its freedom from all gears, pinions, gear cases and motor armatures and motor axle bearings has, as regards these three related subjects, a decided initial advantage over all other designs. It also has an unquestioned superiority in mechanical efficiency as shown by the table:

RELATIVE MECHANICAL EFFICIENCIES	
Motor Design or Connection to Axle	Mechanical Efficiency
Bipolar gearless	100 Per Cent
Quill drive	99 " "
Gear drive (twin gears)	95 " "
Gear to jack shaft and side rods	90 " "
Direct connected jack shaft and side rods	87 " "

The difference in power consumption, due simply to the difference in the mechanical efficiency, may, when capitalized, amount to from one-third to one-half the original cost of the locomotives; in other words, to obtain the same overall economic result a material increase in investment in an engine of higher mechanical efficiency is justified, if such investment is necessary to obtain this type of drive.

In conclusion, it appears that considered from the mechanical design standpoint, Mr. Batchelder's claim for superiority of the bipolar gearless design for high speed service is founded on the incontrovertible facts that this type of engine is safe in operation, superior as to reliability and availability for service requiring no overhaul periods and requiring minimum inspection time, it has the lowest cost of maintenance on account of the elimination of gears, gear case, jack shaft, pin and motor bearings, and its maximum mechanical efficiency insures minimum power consumption.

With Mr. Batchelder's suggestion of the use of a truck center pin located in a well elevated position, all of the advantages of high center of gravity, so far as effect on rail displacement is concerned, can be obtained. On the other hand, with ordinary leading truck designs, it appears that the high center of gravity designs will give a low center of gravity effect by the action of the rear truck on the track unless the high center pin arrangement suggested by Mr. Batchelder is adopted on the trucks. These remarks, of

course, refer to a symmetrically designed locomotive intended to run in both directions.

These features do not seem to have had general recognition, as they should place the bipolar gearless locomotive distinctly in a class by itself, and superior on account of these features to every other design. It is, therefore, to be expected that where the system of electrification will lend itself to the use of this type of locomotive, its application will become very general.

E. B. Katte, chief engineer electric traction, New York Central, stated that the riding of the New York Central electric locomotives had been materially improved by the addition of coil springs immediately over the journals. Before these springs were added, it was possible at high speed to follow the motion of the equalizers with the eye, it was so slow; in the event of any upward movement of the journals, the springs now have the effect of immediately forcing them down, before the effect of the movement is transmitted to the body of the locomotive.

George L. Fowler disagreed with the statement made by the author, in the section of his paper referring to safety of operation, that the rear driver puts a lateral pressure on the rail in excess of that produced by the other wheels, stating that in his experiments to determine the effect of lateral pressure on the rail, he had found that the front wheels invariably gave the highest thrust.

PEAT POWDER AS A LOCOMOTIVE FUEL

The Engineering, London, recently published an account of tests made on the Swedish State Railways with peat powder as a fuel for locomotives in comparison with British coal, in which it was shown that greater efficiency can be obtained by the use of powdered peat. The peat had a heat value of 7,740 B.t.u.'s and the British coal of 12,600 B.t.u.'s, and it was found that 1.45 lb. of peat powder will produce the same quantity of steam as 1 lb. of the British coal. The peat powder was blown through a nozzle into the firebox by compressed air from a steam blower. The firebox was subdivided into an ignition chamber, two side passages and an upper chamber through which the products of combustion are led to and fro before they enter the tubes. Under the nozzle through which the peat is blown, a small grate carrying a coal fire is provided for igniting the peat. The consumption of the coal for this purpose averages 3 to 4 per cent of the weight of the peat powder used. Firebox temperatures of 3,040 deg. F. were obtained with the peat powder, and 2,750 deg. F. with the British coal. A greater degree of superheat was obtained with the peat powder and the smoke box temperatures were generally less. The tests were made over a 60-mile division with a load of approximately 785 British tons. The engines used in the test were of the same type, having 195½ by 25-in. cylinders, 54-in. driving wheels, and 170-lb. steam pressure. It was calculated that the efficiency of the boiler was 73 per cent with the peat-fired engine and about 65 per cent for the coal-fired engine. The following is the analysis of the two fuels used:

	Peat	Coal
Carbon	47.0	73.5
Oxygen	29.5	4.4
Hydrogen	4.5	8.6
Sulphur	0.5	1.5
Nitrogen	1.1	1.2
Ashes	3.2	6.2
Water	14.2	4.6

HOW TO TELL MALLEABLE IRON.—If the break is clean malleable iron will show two distinct colors, white in the center and black on the outside, this black ring extending into the casting from 1/16 to 1/4 inch. Malleable will spark a little but enough to show it is not cast iron, which does not spark at all.—*The Welding Engineer.*

Car Department

ANTI-FRICTION BEARINGS A REMEDY

BY WALTER R. BYLUND
Hyatt Roller Bearing Company, Newark, N. J.

No one who follows the trade papers and technical institute discussions can fail to perceive that the anti-friction bearing is receiving a marked amount of attention. The automobile would not be a practical device if it were not for the anti-friction bearing. We are beginning to realize that other kinds of machinery and vehicles are not efficient without the anti-friction bearings. Therefore, why not use the anti-friction bearings as a medium for eliminating hot box trouble on railway cars?

In the first place wheels were put on a car to eliminate sliding friction. That is to say, rolling friction was substituted for sliding friction. But in doing this only a part of the sliding friction is eliminated because it still takes place between the journal and its bearing. Why not go a step further and substitute rolling friction for sliding friction here also?

I am familiar with the Hyatt flexible roller bearing.

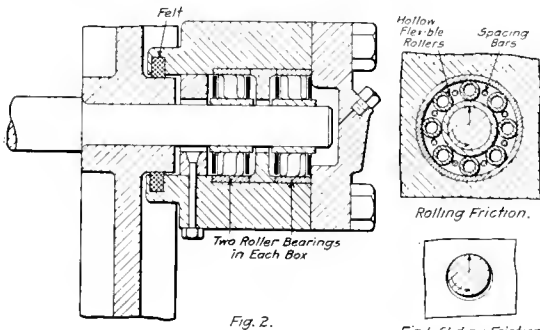

Fig. 2.

Fig 1—Sliding Friction.

Therefore, in this discussion I shall consider this type. The pressure on a bearing is distributed over a narrow strip. That is to say the axle is a free fit in the box and pressure comes on only a part of it. The pressure is not distributed over the whole horizontal projection of the box. Fig. 1 illustrates this point.

When the resultant pressure is large the lubricant is squeezed out easily and in consequence heat is developed faster than it can be dissipated, which causes evaporation of the lubricant. This is one reason for hot boxes. Another cause is the fact that dirt gets into the box and breaks the oil film between the axle and the bearing.

The anti-friction bearings reduce friction, thus reaching the root of the hot box evil. As the friction is reduced the drawbar pull becomes less. P. B. Liebermann, engineer of tests of the Hyatt Roller Bearing Company, Newark, N. J., has run several dynamometer car tests to determine the drawbar pull of mine cars with plain and Hyatt bearings. The saving in drawbar pull in favor of Hyatt bearings was about 50 per cent at a running speed of about 5½ miles per hour. The starting pull of plain bearing cars was 150 per cent

higher than Hyatt bearing cars. These tests were made at the Greensburg Coal Co., Greensburg, Pa. The results were published in the June Bulletin of the American Institute of Mining Engineers.

Of course, freight cars and mine cars are two distinct propositions. However, from these mine car dynamometer tests comparative results are afforded. When an anti-friction bearing equipped car runs at high speed, the saving of drawbar pull is not much over the plain bearing car. The great saving on high speed cars occurs at the time of starting.

Anti-friction bearings save lubricant. This is an important item because the amount of oil and grease that is wasted with plain bearings is enormous. On freight cars the pressure on the bearings is high and the lubricant is squeezed out. On mine cars where the pressure is not so great, Mr. Liebermann found that 80 per cent saving was made when Hyatt bearings were used.

PASSENGER CAR WORK*

BY J. R. SCHRADER
New York Central

Light Repair Work at Passenger Terminals and Yards.—

It is important that minor defects which develop in the course of ordinary service be remedied promptly, as it is just such defects that, unless properly cared for, tend to create other defects of a more serious nature that necessitate the premature shopping of equipment and the expense incident thereto. Some definite system should be adopted to handle the various classes of defects which develop during the trips from one terminal to another. Material should be located at a central point so as to be easily accessible when required for emergency use in repairing cars made up in trains, etc. The conditions existing at various points would, of course, have to govern the organization of such a system, as at some terminals the work is performed on a piecework basis while at others the men are paid on a straight hour basis.

Some of the defects which should be carefully watched for are loose pedestal bolts, loose pedestal tie bar bolts, loose front carry iron bolts, defective brake beam safety hangers and defective brake beam release springs. Another important feature is the maintaining of cotter keys in brake connections, brake beam hangers, spring plank hangers, etc. Wherever possible all brake beam hanger pins, or other pins where a cotter is used, should be so applied that the cotter key is plainly visible when inspection is made.

Terminal or yard inspection, in particular, requires competent employees—men who have had considerable experience on car repair work and who are familiar with all the rules of inspection, which knowledge can only be obtained by previous experience. Great care should be exercised in selecting men for this work. Running gear inspection is the first inspection which a car must receive at a yard or terminal. Wheels, trucks, brake apparatus, etc., should be inspected closely to ascertain if they are in a fit condition for

*Presented at the convention of the Chief Interchange Car Inspectors' and Car Foremen's Association, held in Indianapolis, Ind., October 3-5, 1916.

further service; if not, the defects, whatever they may be, should be repaired locally, if possible. Terminal test of air brakes prior to departure of trains is another matter of importance. The problem of journal lubrication is a special class of work which requires the constant attention of regular men employed and trained especially for it. The men doing this work must be reliable in order that each journal box will be given the proper attention. Although this class of work requires the utmost efficiency, it is impossible to attain it at all times, for the reason that on many roads it is the lowest paid work in the inspection and repair force; consequently the men are continually changing.

Passenger Car Cleaning at Terminals.—Car cleaning at terminals is also an important problem, and a regular car cleaning force should be so organized that this work can be handled in a systematic manner. All passenger cars should be thoroughly cleaned inside and out. Railroads are especially liable to criticism in connection with car cleaning, as the condition of the cars is something with which the traveling public comes in direct contact. Exterior cleaning should be handled as follows: In wet weather the outside of the cars should be washed down with clean water and a brush on a pole of sufficient length to reach to the letter-board of the car. In dry weather the cars should be wiped down with waste slightly saturated with some kind of a cleaning oil. The windows should be cleaned with pulverized pumice and wiped off with a cloth to polish the glass. Close attention should be paid to the corners and to the edges of glass next to the heading to see that the glass does not become grimy. A piece of cloth wrapped around a small stick should be used to get into the corners.

The interior of the cars should be dusted down with a duster and swept with a toy broom. This broom should be spread out fan-shape so that the sweeper can get under steam pipes and in the corners where dirt becomes lodged. Also a small hook should be used to clean under the pipes. After car is swept between the seats and under the pipes with a toy broom, the floor should be swept with a hair floor broom. The interior of car should then be wiped with a cloth. Raw silk can be used to good advantage for this purpose. Mopping of cars should receive close attention. A pail of water with some kind of a disinfectant that will clean as well as disinfect should be used. A toy broom should be used in washing off the steam pipes, foot rests, seat pedestals and for scrubbing the floor, after which the floor should be mopped twice with a clean mop. The seat arms, window sills, leather seats in the smokers and the hoppers in the toilet rooms should be sponged off with disinfectant.

On cars that have double sash windows both sash should be raised and dusted and the surface of glass between the windows should be cleaned by means of a cloth placed on a stick which can be shoved up between the sash. Raw silk, slightly damp, will be found to work to good advantage for this class of work. The outside of the window curtains should be dusted and wiped with waste slightly saturated with some kind of a cleaning oil. The lamps and lamp shades should be wiped with a damp cloth. All washstands should be thoroughly cleaned and the metal work polished. The carpet aisle strips should be taken out and thoroughly swept and blown with air as often as possible. The seat cushions should be cleaned by means of a vacuum cleaner. The vestibules should be wiped with waste slightly saturated with a cleaning oil. The drinking water tanks should be cleaned with live steam at least once in every three days and should be emptied and refilled every trip. The ice should be washed off to prevent the ice compartment becoming dirty.

General Cleaning.—When cars become very dirty so that they cannot be cleaned by ordinary methods they should be given a general cleaning. The exterior of the car should be scrubbed with bead brushes and some kind of a cleaning oil

or paste, after which the car should be wiped thoroughly with cotton waste so that the surface is clean and free from oil. In cleaning the interior all seat backs and cushions should be taken out of the car and the car blown out with compressed air. It should then be washed with linseed oil soap, then thoroughly rinsed off with clean water and wiped with raw silk cloth. The steam pipes, seat castings and floor should be given a thorough scrubbing with old brooms and flushed out by means of a water hose and mopped dry. After the car has been washed, the cushions and seat backs should be replaced and cleaned with a vacuum cleaner so that all dust will be removed.

Economy in Material.—The issuing of material should be carefully watched. New material should not be issued until the old material has been entirely used, as it often happens that the help cleaning cars will try to get new material before the old has outlived its usefulness. When the cloths used for cleaning windows, etc., have outlived their usefulness on this class of work they should be washed and used for other purposes. The foremen in charge should keep a close check on the material, as well as on labor, to see that the cost of car cleaning is kept down to the lowest figure possible to maintain the cars in clean and sanitary condition.

EDUCATE THE MEN

BY GEORGE C. CHRISTY

General Foreman, Illinois Central, McComb, Miss.

Because of the general interchange of freight cars, it is not possible for any one division or any one railroad entirely to correct the hot box trouble. Every terminal or division will have to educate the men who actually do the work to see that journal boxes are given more consideration than merely feeling the box lid as an evidence of the condition on the inside.

Precautions should be taken in turning the journals to make sure that they are true and are in a smooth condition. When the wheels are pressed on, the journals should be coated with grease or paint to prevent rusting; new as well as old journals should be carefully examined before applying boxes. Make sure that the wedge has the proper bearing in the center, that the dustguard is of the right dimensions, that the brass has the proper bearing in the wedge and has a crown bearing on the journal as well as end clearance. One of the principal causes for hot boxes is that the brass has not been correctly tinned when being relined. Be sure that the men understand thoroughly how to do this work and the importance of having it done right. If the brasses are not properly cleaned before reabbtting the abtitt will fall out within a short time, causing the journal to run hot.

In packing the box the waste should be formed in rolls so that there will be a long fibre to the packing in order that the oil may be fed from the cellar of the box to the journal. The packing must not be put in in a haphazard manner. It is not necessary to have it come in contact with the journal above the center line.

In my opinion, every car that goes to the repair track, whether empty or loaded, should have the journal box pulled and the brasses examined and put in proper condition before the car is returned to service. If this were done the hot box problem would be reduced remarkably, as all cars are placed on the repair track for some cause or other within the limit of the time it takes to wear out the journal brass.

In many cases trouble and delays could be avoided if the brakemen had a better conception of how to take care of hot boxes. Often when they notice a box running warm they get a bucket of water and a paddle, push all the packing jam up against the journal at the back and fill the box full of water, floating what little oil is left in the box out on the ground. The result is that the car is often set out, whereas if the packing had been stirred up intelligently and oil applied it would have run safely to the next terminal.

CAR INSPECTION OF VITAL IMPORTANCE*

Inspectors, Because of Added Duties and Responsibilities, Must Be Trained With Greater Care

BY HIRAM W. BELNAP

Chief of the Division of Safety, Interstate Commerce Commission

RAILWAY development of the past few years has vastly increased the importance of the car inspectors' work, and it is my observation that railway managers as a rule have not yet awakened to that fact, or, at least, have not sufficiently appreciated the change in the car inspector's status by making adequate provision to insure the proper performance of his increased and responsible duties. The car inspector's duties are so many and of such grave importance that but few employees in railroad service are called upon to exercise a broader general knowledge of the conditions of safe railroad operation than the man who inspects cars. With the tremendously increased size and capacity of cars, as well as length and tonnage of trains, it is necessary for car inspectors to be better qualified and better informed than the foreman used to be. A car inspector must be thoroughly familiar with the details of construction and maintenance of cars of all classes; he must understand the application of the rules of interchange, which are growing more and more complicated each year; he must know the federal safety appliance requirements in detail, including the air brake system. He must know the rules and regulations governing the loading, placarding, and handling of explosives and inflammable materials, and must be familiar with the requirements governing car clearance on every portion of the road on which he is employed; he must also be able to pass intelligently upon the loading of long materials. *In short, the importance of the car inspector's work has increased to such an extent that the service requirements can only be met by men above the average, both mentally and physically.*

Under present requirements a competent car inspector must be a man of alert mind and more than average intelligence. He must be prompt to act in emergencies, and both able and willing to assume responsibility when the occasion demands. The service is exacting, and the mind must act quickly in order that the man may properly perform the work imposed upon him in the limited time at his disposal. When all is considered, it is astonishing that capable car inspectors are found to perform the multitudinous duties that are imposed upon them, particularly when it is understood that their compensation compares very unfavorably with that given to men of equal mental attainments in other branches of railroad employment.

RELATION OF THE CAR INSPECTOR TO SAFETY

An indication of the necessity for thorough and painstaking car inspection may be had by considering the large number of accidents, with their resulting loss of life and personal injuries, as well as damage to property, due to defective car equipment, as reported in the statistics of the Interstate Commerce Commission. Car inspectors also have it within their power to decrease the number of violations of the safety appliance laws and resulting fines imposed upon the railroads, as well as to effect a considerable reduction in the claims for loss and damage to freight.

During the ten year period 1907-1916 there were 72,122 derailments reported to the Interstate Commerce Commission, of which number 33,782, or 46.8 per cent, were charged to defective equipment. In the total number of derailments which occurred during this period there were 3,334 persons

killed, 51,952 injured, and a property loss of \$62,381,338 was suffered. This property loss includes only the damage to equipment and roadway, and cost of clearing wrecks. Of the above items, defective equipment was responsible for 14.9 per cent of the deaths, 16.3 per cent of the injuries, and 43.5 per cent of the whole amount of property loss suffered in derailments, the figures for defective equipment accidents being 497 deaths, 8,491 injuries, and \$27,160,785 property loss. The derailments due to defective equipment increase steadily from year to year as compared with derailments due to other causes. In 1907 they were 42.7 per cent of the whole, and in 1916 the percentage was 51.5; the average for the ten year period was 46.8 per cent. A tabular exhibit of this increase by specific causes, condensed into five year periods for the sake of brevity, is as follows:

D derailments Due to—	1907-1911	1912-1916	Inc. Per cent
Defective wheels	5,196	5,453	01
Defective axles	1,757	2,166	23
Defective brake rigging	1,845	2,548	38
Defective draft gear	795	1,553	95
Defective side bearings	310	777	150
Defective arch bars	637	1,368	115
Defective rigid trucks	333	1,000	200
Defective power brake apparatus	795	1,584	125
Failure of couplers	723	1,080	49
Miscellaneous equipment defects	1,593	2,359	48
Total	13,894	19,888	43

The number of casualties increased in proportion to the increase in number of accidents, the ratio of casualties to accidents being approximately the same for each five year period. The casualties for the year 1916 total 523, the vast majority of which number affected railroad employees. From the humanitarian standpoint alone steps should be taken to diminish the number of accidents due to this cause, which so greatly increase the hazards of railway employment. The chief hope of a bettered condition in this respect lies largely in diligent and efficient car inspection.

CAR INSPECTION AND PROPERTY LOSS

Nor is the property loss a matter of small importance. The damage to equipment and roadway and cost of clearing wrecks caused by defective wheels increased from \$5,020,617 for the period ending June 30, 1911, to \$5,398,634 for the period ending June 30, 1916. Increases in the other items included under defective equipment are as follows: Axles, from \$1,314,337 to \$1,852,631; brake rigging, from \$1,408,962 to \$1,812,025; draft gear, from \$426,658 to \$940,732; side bearings, from \$225,806 to \$540,418; arch bars, from \$600,089 to \$1,540,091; rigid trucks, from \$189,811 to \$594,074; power brake apparatus, from \$397,587 to \$779,033; failed couplers, from \$337,197 to \$514,952; miscellaneous equipment defects, from \$1,227,230 to \$2,039,901.

For the year 1916 alone the damage to equipment and roadway and cost of clearing wrecks due to defective equipment, amounted to \$3,420,200. If to this sum there is added the amount paid in claims allowed for damage to property and injuries to persons, the annual loss to the railroads chargeable to accidents due to failure of equipment is so enormous as to compel attention, and demand remedies that will reduce this great economic loss of life and property to an absolute minimum.

It may be said that the increases above noted are about commensurate with the increase in the number of units of equipment during the same period, and are no more than

*From a paper on "The Selection and Training of Car Inspectors," presented before the January 12 meeting of the Central Railway Club and copyrighted by that club.

might reasonably have been expected to occur. This would be true provided our starting point represented a minimum, but experience demonstrates that such is not the case. Fortunately, we are able to show that certain kinds of equipment defects to which special attention has been directed, have enormously decreased during this same period, and as a consequence the accidents due to their existence have decreased in like proportion. I refer to the appliances for the protection of trainmen formerly covered by the standards of the Master Car Builders Association, and now subject to regulation by federal statute.

SAFETY APPLIANCE INSPECTION

When the Interstate Commerce Commission first instituted its inspection service, the railroad car inspectors had not been educated to give special attention to those units of equipments included in the standards for the protection of trainmen, and their inspection was not as thorough as it should have been. The first year of the Commission's work of inspection for which we have a complete record is the year 1902. In that year the Commission's inspectors inspected 161,371 cars and found 42,718 cars, or 26.47 per cent of the number inspected defective with respect to the items to which their inspections were directed; that is, out of every 100 cars inspected about 27 were found defective. For the year 1916, out of 908,566 cars inspected, only 33,715, or 3.72 per cent, were defective. This notable decrease occurred notwithstanding the fact that, owing to an extension of the law in 1910, inspections now cover a great many appliances that were not included in the earlier inspections.

There can be no doubt that this great decrease has been brought about by the education and training of car inspectors. When the federal inspection service was inaugurated railroad car inspectors had but vague and indefinite notions of the law, and they had received no special instructions relative to inspection of appliances covered by the federal statute. In many cases they looked upon the government inspectors as enemies, and devoted more attention to attempts to evade the law than to measures for compliance with it.

A few years ago, under the direction of the secretary of the Interstate Commerce Commission, accompanied by another inspector, I made an inspection on one of the large eastern trunk lines. During this inspection we were accompanied by one of the mechanical officers of the company, with authority to request at each inspection point that all of the available car inspectors might be assembled, so that the safety appliance acts and their application might be discussed. At each inspection point from four to twenty car inspectors were assembled, and the fact that impressed itself more than any other upon my mind was that each of these employees seemed to be hungering for information concerning the safety appliance work. The men were taken to a train yard where all classes of cars were available, and every question that they asked concerning the appliances covered by the law was fully explained. In many instances the men frankly stated that it was the first time they had ever had the safety appliance requirements explained to them in an understandable way, and it was indelibly impressed upon my mind at that time that the thing most needed to bring about a thorough understanding regarding the law was a system of instruction concerning it, so that those charged with the maintenance of these safeguards might have full information, not only as to their number, location, dimensions and manner of application, but also as to their necessity.

Within the past 15 years the Interstate Commerce Commission has distributed hundreds of thousands of documents for the education of car inspectors on various phases of the law, and has carried on an educational campaign through

its inspectors which has been productive of marked results. Car inspectors now understand that it is our purpose to cooperate with them in accomplishing the ends of the law, and practically all of them have a good working knowledge of the statutes and their duties under them.

PROSECUTIONS UNDER SAFETY APPLIANCE ACTS

In addition to the influence which our educational campaign has had, much good has been accomplished from the work of railroad managers in their efforts to reduce the number of prosecutions for violations of the law. This influence has induced them to pay special attention to the work of their car inspectors with relation to safety appliances. Inspectors have been impressed with the necessity of paying strict attention to the inspection and repair of safety appliance defects; some roads have appointed traveling inspectors, whose duty it is to instruct local inspectors with respect to compliance with the law, all of which has proved of considerable profit to the roads, and points the way to similar benefits in connection with general inspection. A brief statement of prosecutions under the safety appliance law may prove of interest.

Up to June 30, 1916, there had been prosecuted under the safety appliance acts 2,033 cases involving 6,544 violations of these acts and penalties collected, exclusive of costs, to the amount of \$479,300. A tabulation of these cases recently made discloses the interesting fact that of the total number prosecuted, 3,038, or approximately half, were for inoperative and defective uncoupling mechanisms—defects readily discoverable by inspection. The defects constituting these cases for prosecution are all ones that could easily and inexpensively have been repaired, and cover such simple defects as broken or missing keepers, disconnected and kinked uncoupling chains, missing uncoupling levers, etc., showing that the most prolific cause of prosecution is from a source probably most easily remedied. Defective or missing handholds have been the next most frequent cause of prosecution, there having been 1,875 such cases, or about 30 per cent of the total number of violations, these again being defects easily discovered and remedied at a minimum cost. The 303 cases of link and pin couplers, 168 cases of broken or missing couplers and 160 cases of couplers either too high or too low were fruitful of additional great expense to the carriers in penalties paid, while the 273 cases in which trains were hauled without the percentage of air brakes required by law shows the necessity for more thorough inspection.

Care and diligence in supervising and training engine and train employees have assisted materially in bringing the volume of collisions on American railroads in the last decade from 8,026 in 1907, to 4,770 in 1916. During the same ten year period derailments (46.8 per cent of which were due to defective equipment) increased from 7,432 in 1907, to 7,904 in 1916, of which latter number 4,073, or more than 50 per cent, were due to defects of equipment. These statistics suggest that a similar record might be possible if the same care and diligence were exercised in the supervision and training of the men in the car inspection service.

More frequent, more careful, and more intelligent inspection would most certainly lead to the prevention of a great majority of equipment derailments. While it is true that inspection of cars and locomotives in a train at inspection points must, under modern conditions, be more or less superficial, yet the practiced eye and the trained ear of the expert inspector are enabled to detect defects which to the untrained and inexperienced are undiscoverable. The younger and more inexperienced men should have work in the field with men of experience in detecting defects, supplemented with class-room work which should show by means of failed materials exactly where and how the various integral parts

fail and how these defects may be discovered in the train. In any event, the car inspector is practically the only person that you can depend upon for a reduction in accidents due to defective equipment.

SACRIFICING SAFETY FOR DESPATCH

An important influence which militates against proper inspection of cars, particularly at terminals and division points, is the hasty manner in which railroad work is usually performed. The desire to maintain train schedules and prevent terminal delay in the movement of cars is, of course, highly commendable. It cannot be denied that every effort should be made to keep cars moving, and prevent delays by all proper means. This effort is often carried to extremes, however, and results in the sacrifice of safety for despatch. In many instances, train schedules are so arranged that entirely too little time is allowed for thorough inspection of passenger trains at terminal and division points, and particularly for the repair of such defects as may be disclosed by inspection. The cars have to be inspected practically "on the run," the inspector working under constant fear that he may be criticized for holding the train past its schedule leaving time, or in excess of the dead time shown on the card. The situation is not improved by the station or trainmaster, whose main thought is to prevent delay to the train while it is under his jurisdiction, and who is inclined to impress this thought upon the car inspector with unnecessary emphasis. Under such conditions the tendency to make inspections in an entirely superficial manner, and to slight, or entirely neglect, work that should receive careful and painstaking attention, is altogether too common.

Our accident investigations have disclosed numerous cases of improper inspection, due to lack of sufficient terminal time, as well as instances in which important high-speed passenger trains have been permitted to go forward with cars in defective condition. In several cases trains have gone forward without the required percentage of air brakes in operative condition. Investigation developed the fact that the inspectors had never been given definite instructions relative to the number of cars with brakes cut out to be run in a passenger train, the practice being to cut out the brakes if replacing the brake shoe would result in considerable delay.

RAILROADS SHOULD INSTRUCT INSPECTORS

A number of railroads have published instruction books and examination questions for the benefit of car inspectors and repairmen, but I have seen none of such that refers to anything except the air brake. It goes without saying that car inspectors and repairmen should have a good working knowledge of the air brake, but it occurs to me that it is fully as important that they should be instructed and examined concerning the M. C. B. standards relating to car construction and equipment, rules of interchange, etc., as well as all requirements of the laws. That there is a demand for instruction in such matters is proved by the fact that private parties have found it profitable to undertake the publication of books purporting to give the federal requirements, such books as a rule being merely copies of government publications. Car inspectors should not be required to buy books of this sort from private parties. Such information should be given them freely by their employers, to the same extent that air brake information is freely furnished. To operate a railroad without a comprehensive set of rules and instructions for train and enginemen, and without subjecting these men to examinations to insure that the rules and instructions are understood is unthinkable. Why is it not fully as important to know that car inspectors are fully informed concerning their duties and are competent to perform them?

SELECTION AND TRAINING OF INSPECTORS

Many addresses have been given and a large number of papers published with reference to methods of selecting and training men for different branches of railroad employment, but the bulk of the literature on this broad and important subject deals principally with the selection and training of employees for promotion rather than with that phase of the question which concerns us most directly here, namely, the selection and training of car inspectors properly to inspect and repair cars. It is self-evident that the workman of today, instructed and trained in the proper performance of his duties, will furnish good material for a foreman or other officer later on, and if the men in the ranks are up to standard in training and proficiency the problem of securing available men for promotion will be very much simplified.

The selection of men for employment in different capacities is a question which can be and is theorized about almost without end, but a great deal of such theorizing is visionary, and at any rate as applied to the employment of car inspectors, is entirely impractical. If there were ten applicants for every job, some discrimination in the selection of the one man could be exercised, and a method of elimination could be adopted for weeding out those not suited to the work. But no doubt most of you would tell me that the number of inspectors required is so large that considerable difficulty is found in getting a sufficient number of capable men for this purpose, and this difficulty is not improved by the low salaries which are paid to these men.

It is essential that the selection of men for employment as car inspectors should be assigned to some officer who not only is well informed regarding the duties and requirements of that position, but also who has some particular qualification or ability of sizing up men. And it is my belief that car inspectors should be recruited from the ranks of the repairmen. The inspector should have at least a common school education; he must be able to write a repair card in a legible manner, as well as to make out clear and comprehensive reports, and in order that he may have the necessary knowledge of car construction, he must have served for a considerable period on the repair track or as an apprentice car carpenter.

SANTA FE HAS FREIGHT CAR APPRENTICES

A modern apprenticeship system for car department employees is just as desirable and essential as for the mechanical and other departments. It is reported that of the 974 apprentices on the Santa Fe on May 31, 1916, 148 were freight car apprentices and 25 were car builder and coach carpenter apprentices.

At a recent meeting of the New York Railroad Club, F. W. Thomas, supervisor of apprentices for the Atchison, Topeka & Santa Fe, presented a very interesting and instructive paper upon the subject of "Training Young Men for Positions of Responsibility," showing the splendid results obtained by that railroad through its apprenticeship system. After carefully reading this paper, to my mind two thoughts stand out prominently: first, the manner in which these apprentices are treated from the time they first enter the service until they are placed in positions of responsibility; and second, the close supervision that is at all times given them during their course of apprenticeship. If similar conditions of service and supervision were applied to the training of car inspectors, I feel certain that there would be not only a bettered condition of equipment upon our American railroads and a remarkable decrease in accidents, but instances of prosecution under the safety appliance laws would be eliminated.

The practice is far too common to employ men as car inspectors and then to give them no special instructions or training. They are put to work and expected to pick up what information they can concerning the duties required

of them from other car inspectors, not too well trained themselves. It is a safe venture that nine out of ten inefficient car inspectors fail to measure up to their jobs on account of either lack of interest or lack of proper instruction and training, rather than inability to do the work required. This brings us face to face with the proposition that a workman is to a great extent what his boss makes him, and that the immediate superior of the car inspector is largely responsible for either his efficiency or his incompetency.

TRAVELING CAR INSPECTORS

Some systematic method of instructing car inspectors regarding their duties, and educating them regarding the importance of their work, should be adopted. It may be feasible to assign the duty of instructing car inspectors to the foreman, although in some cases no doubt it will be found necessary to instruct the foremen themselves, and assign the duty of further instruction to other employees. Another plan which holds much promise is the employment of traveling car inspectors who instruct the men and from time to time check up the condition of equipment and methods employed in the different train yards. It cannot be doubted that the knowledge that a traveling car inspector is on the road and likely to drop into a yard at any time has a stimulating effect upon car inspectors and their foreman. It is believed that the employment of a sufficient number of such traveling car inspectors to permit of checking up conditions in yards frequently would be beneficial. One such traveling inspector recently stated that while he had noted a marked increase in the efficiency of the inspection force at a large terminal on his line, he recently made an inspection of car and safety appliance equipment on freight trains leaving that terminal and discovered two defects, both of which happened to be penalty defects.

In how many of our large railroad terminals do the foremen of car inspectors go over trains personally? It may be granted that usually the foremen are well informed regarding the standards and requirements for car equipment, but too often their entire time is taken up by other duties which confine them to their office, and the foreman may not be aware of defects getting by one or more of his car inspectors until complaints regarding defective equipment leaving his terminal or inspection point are brought to his attention. It has been suggested, in order to require a foreman to check up his men more closely and to know that they are properly performing the duties required of them, that periodical reports regarding each inspector on his force be submitted to the general foreman of car inspectors.

A point which will bear much consideration and emphasis is to make the job as interesting for the man as possible. Many car inspectors will be found who are letter perfect, for example, in the United States safety appliance standards, but how many car inspectors, or even foremen of car inspectors, know why four ladders are required on a box car or why grab-irons must be at least 16 in. long and have a clearance of not less than $2\frac{1}{2}$ in., and the reason for their definite location? In any case, it is desirable for the man to display some enthusiasm for his work and to take pride in doing it well. He will not display any enthusiasm for his work unless he feels it, and the basis for any such enthusiasm must be first of all a certain respect for his position.

DIGNIFY THE JOB

We hear much in these days of the desirability of men feeling enthusiasm for their work, and displaying loyalty to their employers' interests. Enthusiasm and loyalty are the necessary pre-requisites of efficiency. Unless a man feels enough interest in his work to be enthusiastic about it, he will value his job only for its material advantage to himself, and his feeling of loyalty to the interest of his employer will usually be a minus quantity. To create this

feeling of enthusiasm and loyalty in the car inspection service, the position of car inspector must be made worth while. It must be made a preferred job; one that men in the lower ranks will strive to attain, not alone for its material rewards, but also for the position and importance that goes with it. If men are made to feel that their work is considered important, worthy of consideration, valuable to their employer, they will naturally feel enthusiastic about it, and the men below will strive with might and main to attain the higher position. When an organization is permeated with that sort of enthusiasm the question of loyalty may well be permitted to take care of itself.

Several definite propositions may be suggested for building up a proper regard for the work. One of the most important of these is a written examination for all car inspectors upon their employment, and subsequent periodical examinations, similar to examinations for train service employees. The inspector should also be furnished with information regarding the cost of materials used, and should be impressed with the value and importance of his work to the company. It has been suggested that there is frequently too much criticism and fault-finding, without constructive suggestions, on the part of supervising officers. Active interest and encouragement from the men higher up are essential to that "team work," without which the highest standard of efficiency is unattainable.

I may here cite another incident from my personal experience, which illustrates in a striking manner one of the evils to which the car inspection service is subject: On one occasion, accompanied by a general foreman in charge of a terminal, an inspection was made of a train ready to leave that terminal, which had cars in it on which were found a number of penalty defects, and if the train had been permitted to go forward it would have meant prosecution in the federal courts. After the inspection was completed an inspector was called to the office and inquiry was made as to whether or not he had inspected the train in question, and when it was ascertained that he had done so, the general foreman called his attention to the six serious and dangerous defects which existed on the cars in the train, and then and there dismissed him from the service. The next day this inspector informed me that in the two years he had worked in that yard it was the first time he had ever seen the general foreman in the train yard, and that at no time had he ever received any instructions relative to the requirements of the safety appliance acts.

The government has written upon the statute books a number of laws intended to lessen the risk of railroad employment, as well as prevent accidents, but no law, no matter how rigidly enforced, can correct evils that are directly chargeable to the failure of employees properly to perform their duties.

No class of men as a rule have a keener appreciation of their responsibilities than railroad employees, and any failure in duty on their part is often a form of thoughtlessness in which the chief motive is haste, or due to the fact that a full and complete understanding of their work is lacking. This, I believe, is particularly true in the car inspection service. One of the most encouraging signs of the times, to my mind, is that the railroad managers and employees in every branch of service are co-operating, through safety committees, in a campaign of education in which all interested participate for the common good, and from which is certain to result an improvement both in safety conditions and personnel.

In all branches of service, but particularly in the car inspection service, the system of education must go farther. Each of the appliances required on cars in the way of safety appliances were fixed only after most careful thought, as well as a study of the years of experience of the carriers, as indicated by the requirements fixed by the Master Car

Builders' Association. Car inspectors should be trained and educated so that the underlying reasons for all safety appliances are fully understood and comprehended.

The prominence which is given the work of the car inspector in recent discussions of railroad operating problems, is evidence that his importance as a factor in safe and economical operation is coming to be appreciated at its true worth. At the recent convention of the Chief Interchange Car Inspectors' and Car Foremen's Association, in Indianapolis, the scope of the membership was broadened so as to include car inspectors, and for the first time the association took up the discussion of general questions relating to car department problems, instead of confining itself entirely to the M. C. B. rules of interchange. Representative railway officers addressed the convention, the burden of their remarks being the importance of the car department and the necessity of selecting good men to perform the work imposed upon it.

F. W. Brazier, superintendent of rolling stock of the New York Central Lines, pointed out very clearly how the number of derailments could be reduced by more careful inspection, and very truly stated to the convention that there was no subject which it could take up that would result in more good to the railroads than better maintenance of equipment. He presented figures to show that of 25,550 cases of derailment, 32.5 per cent were chargeable to equipment failures. To use the words of an observer at this convention, as reported in the *Railway Mechanical Engineer*, "Car inspectors and car foremen! Officers in the mechanical and operating departments have sometimes elbowed them aside as if they were not worthy of or capable of the bigger things in the mechanical department. Times have changed. With the more severe and exacting conditions it has become apparent that just as high, and possibly a higher degree of executive and technical ability is required to solve car department problems and handle the labor question as in the locomotive and operating departments."

CONCLUSIONS

This whole question is a complex problem, worthy of the most thoughtful consideration of those high in authority in railroad management. In the suggestions I make in this paper I therefore avoid anything but the most general reference to what field the instruction and training of car inspectors should cover. The points which I have attempted to cover may be briefly summarized as follows:

(1) Railway development has vastly increased the importance of the car inspector's work within recent years, and adequate provision must be made to insure the proper performance of his duties.

(2) Over 46 per cent of all derailments which occurred on the railroads of the United States during the ten year period 1907-1916 were due to defects in equipment. These derailments caused 14.9 per cent of the deaths, 16.3 per cent of the injuries, and 43.5 per cent of the property loss suffered in all derailments during this ten year period. Derailments due to equipment defects are steadily increasing from year to year, and the chief instrumentality which the railroads must depend upon to improve this condition is the car inspector.

(3) That education and training of car inspectors is effective in reducing the number of equipment defects is proved by the record of decrease in defects reported by federal inspectors. In 1902, the defective cars reported were 26.47 per cent of the whole number inspected, while in 1916 the percentage was but 3.72, notwithstanding that the inspection in 1916 covered a great many appliances that were not included in the earlier inspections. This notable decrease has been brought about by the campaign of education which the Interstate Commerce Commission has carried on through its inspectors, by the distribution of thousands of documents, and by the work of railway managers in their efforts to

reduce the number of prosecutions for violation of the law.

(4) An important influence which militates against proper inspection is the haste with which such work is usually performed. In many cases train schedules are so arranged that entirely too little time is allowed for thorough inspection of passenger trains, and the inspector is working under constant fear that he will be criticized for holding the train past its schedule time. Under such conditions the tendency to make inspections in a superficial manner and to slight or neglect work that ought to be done, is altogether too common. Our accident investigations have disclosed cases of improper inspection, due to lack of terminal time, in which important high-speed trains have been permitted to go forward with defective brakes, and in some cases without the lawful percentage of brakes in operation. In these cases the inspectors have stated that they had never been instructed about cutting out brakes on passenger trains, and it was their custom to cut out brakes, if replacing worn out brake shoes could not be done in the time allowed.

(5) The selection of car inspectors should be assigned to some official who is well informed concerning the duties of the position and who has some ability in reading character. Generally speaking, inspectors should be recruited from the ranks of the repairmen. Before being placed at work in this responsible position, it should be thoroughly drilled into them that any omission to detect defective equipment is fraught with danger to life and limb. They should be efficiently instructed as to each standard of safety involved in the safe running of the car, and such standards should be formulated in rules as far as such formulation of fixed rules is practicable. An inspector should have at least a common school education; he must be able to write a repair card in a clear and legible manner, and make out clear and comprehensive reports. A modern apprenticeship system for car department employees is just as desirable as for the locomotive or other departments.

(6) It is believed that nine-tenths of the inefficient or incompetent car inspectors fail to measure up to their jobs, either through lack of interest or lack of instruction and training, rather than through inability to do the work required. To create the requisite interest and enthusiasm for the work the job must be made worth while. It should be made a preferred position, which men in the lower ranks will strive to attain, not alone for its material rewards, but also for the dignity and importance that goes with it.

(7) Definite propositions for inculcating proper regard for the work are: written examinations covering all matters, concerning which inspectors must be informed, such as Master Car Builders' standards, rules of interchange, federal requirements, rules for loading long materials, regulations for the loading and handling of explosives and inflammable materials, strength of materials, etc., periodical examinations leading to line of promotion, similar to examinations given train service employees; schools of instruction where men may be taught concerning their duties; proper supervision and adequate compensation.

DISCUSSION

F. W. Brazier (N. Y. C.) commented on the extravagance of departing from approved designs and specialties to save a few dollars in the first cost of cars and then spending many times more in maintenance to keep them in service. Railroad officers could save much trouble and expense if they would study government reports more closely, with a view to remedying the defects which cause the greatest trouble. It is a serious mistake to repair cars in kind if they get out of order shortly after the repairs are made. Wooden door stops were cited as a case in instance. Moreover, some roads, although the capacity of the cars and size of doors on box cars have been considerably increased, are using the same door fixtures as they did 15 years ago. It

is little wonder that trouble is experienced. On the New York Central extra compensation is paid to inspectors, and especially in passenger car work, for finding hidden or obscure defects that in the judgment of the foreman would not have been discovered in the course of ordinary inspection.

W. H. Sitterly (Gen. Car Inspector, Pennsylvania, Buffalo) thought that proper training of car inspectors is afforded by having foremen car inspectors who have the backing of the higher officers. Inspectors at interchange points should first serve in classification yards. One source of trouble is the issuing of orders to foremen car inspectors by officers who have never had experience in that work. The car inspector is receiving greater recognition today than in the past.

P. J. O'Dea (G. I., Erie) said that car inspectors had been much neglected and that there is immediate necessity for a broader and more liberal treatment of these men. Certain rules were drawn up for the government of car inspectors by the M. C. B. Association in 1902. Because of changed conditions these rules are obsolete, and yet they are printed in the proceedings from year to year, with no effort to make them effective. Car inspectors should receive a wage in keeping with men of similar skill and industry in other fields. The public demands better and safer service. It will be a good investment to take measures to insure a better and higher grade of inspectors. As important as monetary returns is the necessity of interest and backing from the higher officers. The value of traveling inspectors in checking the work and bringing up the standards has been demonstrated.

R. V. Wright (*Railway Mechanical Engineer*) advocated the necessity of giving more attention to the selection of freight car repairmen and of educating them not only to a better performance of their work, but with a view to future promotion to positions of greater responsibility. It is from these men that most of the car inspectors are selected, and there is no reason to believe that this practice will not continue. Attention was directed to the efforts being made by the Chief Interchange Inspectors' and Car Foremen's Association along these lines.

T. J. O'Donnell (Arbitrator, Niagara Frontier Car Inspection Association) thought that the expenditure of upwards of \$100,000,000 by the railroads in the last 10 years in bettering the equipment was an indication of sincerity on their part in meeting the demands of the government and public opinion for better and safer service.

J. P. Carney (G. C. I., Mich. Cen.) emphasized the value of a bonus, or extra compensation for the discovery of hidden or obscure defects.

Henry Boutet (C. I. I., Cincinnati) stated that the car inspector was held responsible for inspecting the trains and should not allow them to depart until his work had been properly and thoroughly done. He suggested that Mr. Belnap arrange to have his men hold schools at various important points to instruct the railroad inspectors as to exactly what was required by the government.

CAR DEPARTMENT APPRENTICES*

BY W. K. CARR

Chief Car Inspector, Norfolk & Western, Roanoke, Va.

The car department apprentice is only a boy actuated by all the inclinations of youth; at the same time he is usually susceptible to reasoning and good training. It is not, as a rule, a difficult matter to care for a genius or a boy who has a natural bent for mechanics and is intensely interested in

his selected work. But the handling of the average boy may be a problem, and a very serious responsibility. Many boys, even below the average in interest and natural aptitude for mechanics and car work, often make good men and reach positions of authority due to their cleverness as executives.

A boy's initial work in the general car department may largely depend upon his previous training. The boy that has had no training should first enter the passenger car frame or body shop. There he would be able to see the results of skill; at the same time the work should not be sufficiently wearing on him physically to dampen his interests and desires. In the passenger department he would better understand the relation of the various parts to each other, and in a general way see why the details are of certain sizes, etc. It is desirable to lead the boy along natural steps, allowing him to progress from one shop to another so that the opportunities offered will be in sequence, and the boy's advancing experience will have better prepared him to add to his accumulating knowledge.

The special advantages offered by promoting the boy from the passenger body works to the passenger car truck and platform gang would be on account of the latter embracing so many real problems of passenger car equipment, operation and maintenance that may not be so well appreciated if such work is taken up in advance of the acquirement of knowledge as to the general construction, names and functions of the various parts. If the apprentice will apply himself he will soon become trained to look for broken parts, excessive wear, lateral motion and other defects likely to develop in train service, some of which produce rough riding equipment; also those defects that may affect safety.

The apprentice should remain at least 12 months on body, truck and platform work. Opportunity for becoming familiar with the different lines of construction should be offered the apprentice to the fullest possible extent, and here is where the foreman can be of great assistance to the boy. In fact, much depends on the aid and encouragement offered by the foreman and associates. Of the two schedules given below, one contemplates three months on new freight car work and six months in the drawing room, where it can be offered. Both schedules also show how time may be otherwise distributed.

Departments	Months	Months
Passenger car body and truck shop.....	12	12
Freight car—new work.....	3	3
Freight car—truck.....	3	6
Freight car—repairs—wood (general).....	6	6
Freight car—repairs—steel (general).....	6	6
Air brake department.....	3	4
Freight—operating yard—inspecting and air brake pipe work.....	3	6
Passenger trimming shop.....	3	4
Drawing room.....	6	6
Passenger car body.....	3	4
Total.....	48	48

Beginning the second year, the apprentice should either go on freight car work of the various sorts, or drop into the freight car truck gang and be assigned to general truck work and steel cars. About six months can be well spent in such duties affording invaluable opportunities to secure experience in all freight car construction work, and it would also tend to harden or build up the apprentice physically for the freight car repair work, where he should next be directed for a period of about six months each on wood and steel car general repair work. The apprentice should then be in a receptive condition for three or four months in the air brake department. From there he should move to the freight operating yard, and be assigned to car inspection and also air brake pipe work for a period of about three months. Here he will have opportunity to see defects which result from service.

After the yard experience the apprentice should spend three or four months in the passenger trimming shop, and then enter the drawing room, always being noticed and encouraged by the foremen, finally finishing his time in the passenger car body shop.

*This article was awarded the third prize in the competition held by the Chief Interchange Car Inspectors' and Car Foremen's Association for the best article on Car Department Apprenticeship. The result was announced at the annual convention of the association, held at Indianapolis, Ind., October, 1916.

STEEL PASSENGER CARS FOR D. & H.

Two Designs of Coaches Differ Chiefly as to Seating Arrangement; Ventilated Baggage Cars

MANY noteworthy features of design are found in an order of cars for passenger train service, recently put in service by the Delaware & Hudson, which included nine coaches built by the Barney & Smith Car Company, and nine coaches and six baggage cars built by the American Car

steel platform and double body bolster is used. The double center sills are of the fishbelly type, 26 in. deep at the center, with 5/16-in. web plates, set 18 in. center to center. The cover plates are 7/16 in. by 30 in. with 3 1/2-in. by 3 1/2-in. by 1/2-in. angles riveted to the outside of the web plate at the

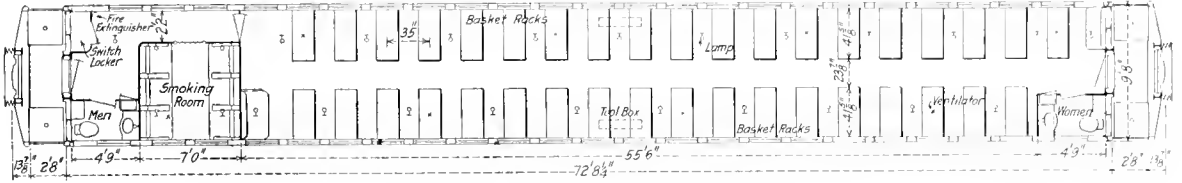

Floor Plan of D. & H. Coach with Smoking Room

& Foundry Company. Data concerning these cars will be found in Table I, and a comparison of the cars with others of similar type in Table II.

The principal dimensions and nearly all the details of the

top and to both inside and outside at the bottom. The crossbearers are built up of a cast steel section riveted to the web plates on either side, further secured by top plates 5 in. by 1/2 in. extending across the cover plates and under the angles

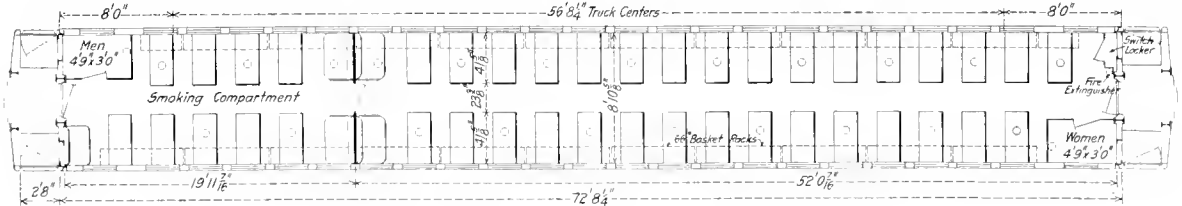

Floor Plan of D. & H. Coach with Smoking Compartment

coaches from the two builders are the same, but a change has been made in the seating arrangement, the cars built by the Barney & Smith Company having a smoking room accommodating six persons and seats in the main portion of the

which form the bottom of the center sills, to which the crossbearers on either side are riveted. The side sills are angles 6 in. by 4 in. by 3/8 in., riveted to the crossbearers and body bolsters, and the floor beams are 6-in. 8-lb. channels, riveted

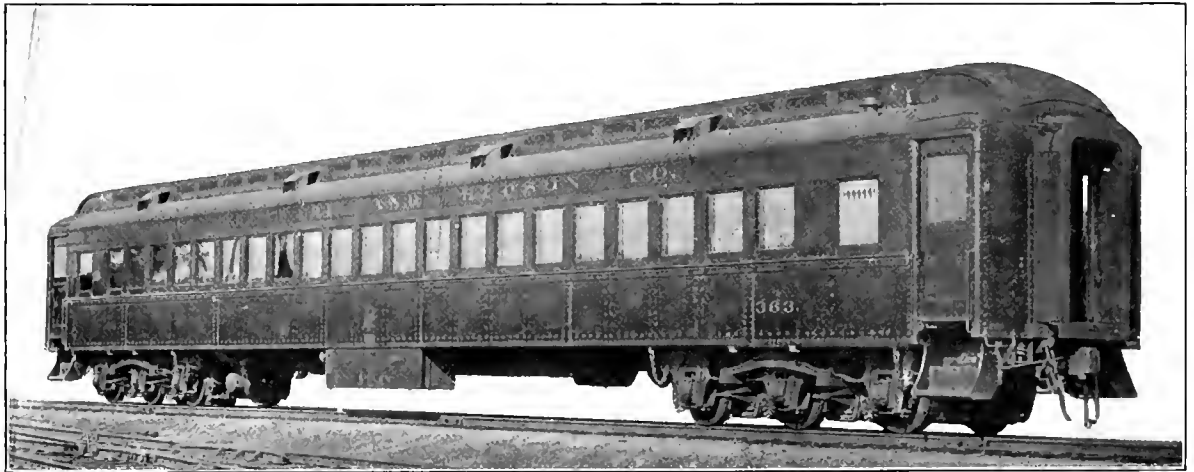

Steel Coach for the Delaware & Hudson

car for 78 passengers, while one end of the cars built by the American Car & Foundry Company is partitioned off to form a smoking compartment, the seating capacity of the smoking section being 24 and of the main compartment, 66 persons.

In the construction of the underframe, a combined cast

to 1/4-in. pressed angle brackets on the web plates and side sills. In the cars built by the Barney & Smith Company, a false floor, made of 1/16-in. plate is secured directly to the floor beams and above this the wooden floor stringers are placed. The American Car & Foundry Company makes use

of 3-in. by 2½-in. by ¼-in. angles, fastened to brackets resting on the floor beams to furnish a support for the false floor at the level of the center sill cover plates. The longitudinal floor support between the body bolsters and the end

posts under the window stools. The side posts are fastened at the top to Z-bar side plates which carry the lower deck carlines, the latter being pressed steel, of channel section. Between each of the carlines is a 1½-in. by 1½-in. by 3/16 in.

TABLE I.—WEIGHTS AND DIMENSIONS OF NEW CARS FOR THE DELAWARE & HUDSON

Cars	Total weight, lb.	Dead weight, lb. per passenger		Length inside	Truck		
		Smoker	Coach		Type	Journals	
Coach	146,200	1,740	78	6	71 ft. 11¼ in.	Six-wheel	5 in. by 9 in.
Coach	138,710	1,541	66	24	71 ft. 11¾ in.	Six-wheel	5 in. by 9 in.
Baggage	110,440				60 ft. 0 in.	Four-wheel	6 in. by 11 in.

TABLE II.—COMPARATIVE DATA ON STEEL COACHES.

Railroad	Total weight, lb.	Seating capacity	Dead weight, lb. per passenger	Length over end sills	Type of truck
D. & H. Co.	146,200	84	1,740	72 ft. 8¼ in.	Six-wheel
D. & H. Co.	138,710	90	1,541	72 ft. 8¼ in.	Six-wheel
Boston & Maine	120,000	88	1,364	70 ft. 3½ in.	Four-wheel
Pennsylvania	120,000	88	1,364	70 ft.	Four-wheel
New Jersey Central	115,800	78	1,480	63 ft.	Four-wheel
New Haven	131,030	88	1,488	70 ft. 6 in.	Six-wheel
Can. Nor.	140,000	84	1,670	72 ft. 6 in.	Six-wheel
New York Central	142,000	84	1,690	70 ft.	Six-wheel

of the car is formed by 2½-in. by 2½-in. by 3/16 in. angles which are riveted to the flanges of the platform casting. The floor stringers are riveted to the false floor and supporting angles.

The side posts of the cars built by the Barney & Smith Company are of a flanged U-section, as shown in the drawings, while the American Car & Foundry Company employs two channel sections of pressed steel, with the flanges turned toward each other to form the posts. In both designs pressed sections are used to form the window casings. The end posts are built up of Z-bars and pressed steel shapes. A belt rail ½ in. by 4 in. extends the entire length of the car body, and a pressed steel belt rail stiffener extends between the side



Interior of One of the Coaches Looking Toward the Pulman Smoker

angle which serves as an additional support for the lower deck roof. The inner ends of the lower deck carlines and roof supports are fastened to an angle iron which, with the carlines, supports the deck posts, which are similar in sec-

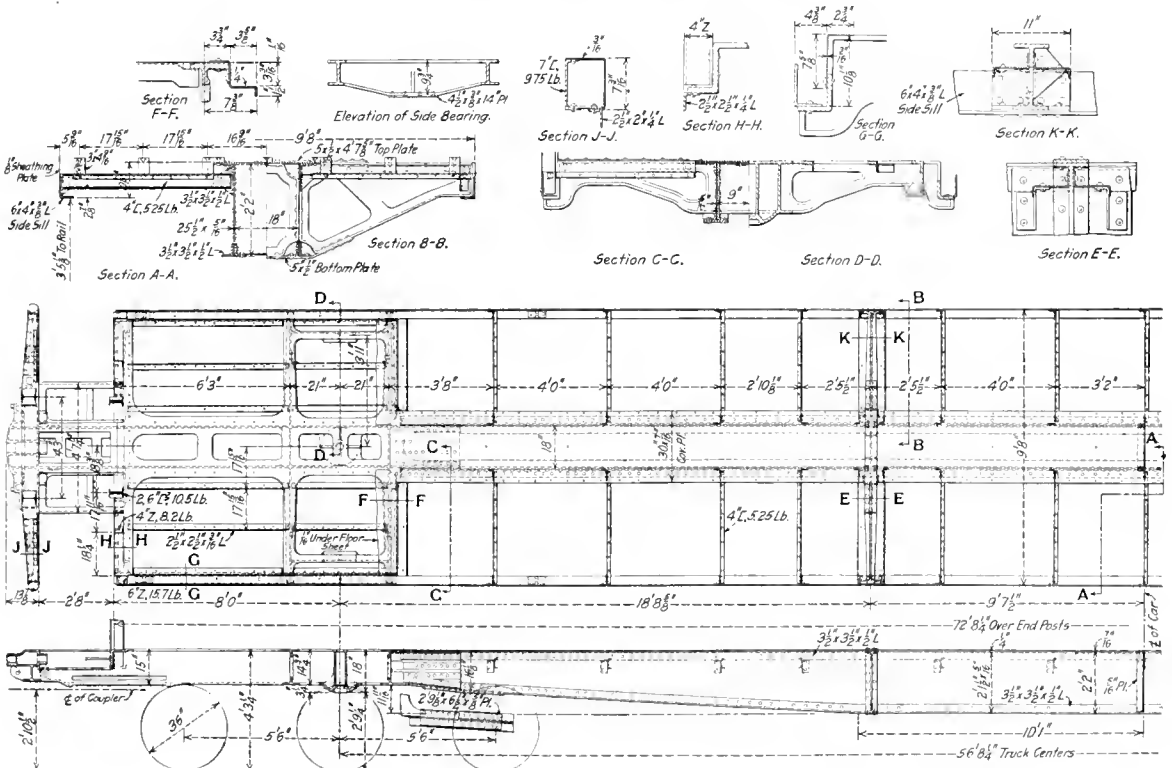

Underframe of the D. & H. Coaches

tion to the side posts. A pressed steel channel with unequal legs is riveted to the top of the deck posts and carries the upper deck carlines, in which the side post section is again

nels, weighing 10.5 lb. per ft., riveted together through the webs. Between the corner posts and door posts is an intermediate post, for which a 4-in. 8.2-lb. Z-bar has been used

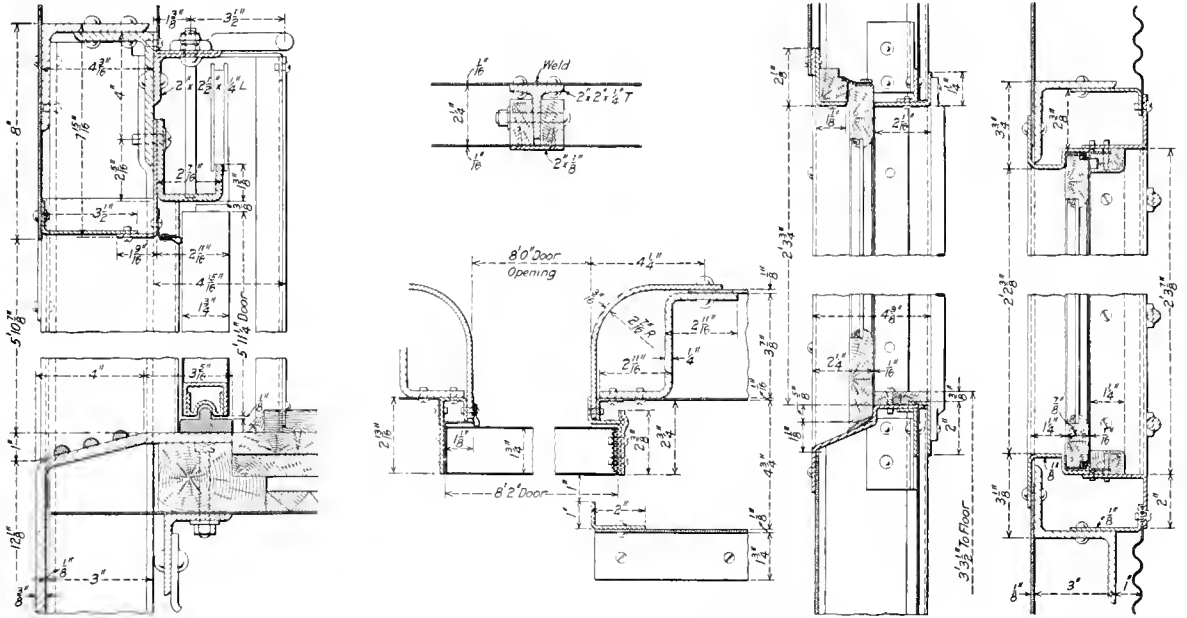

Sections Through Floor and Window of Baggage Car

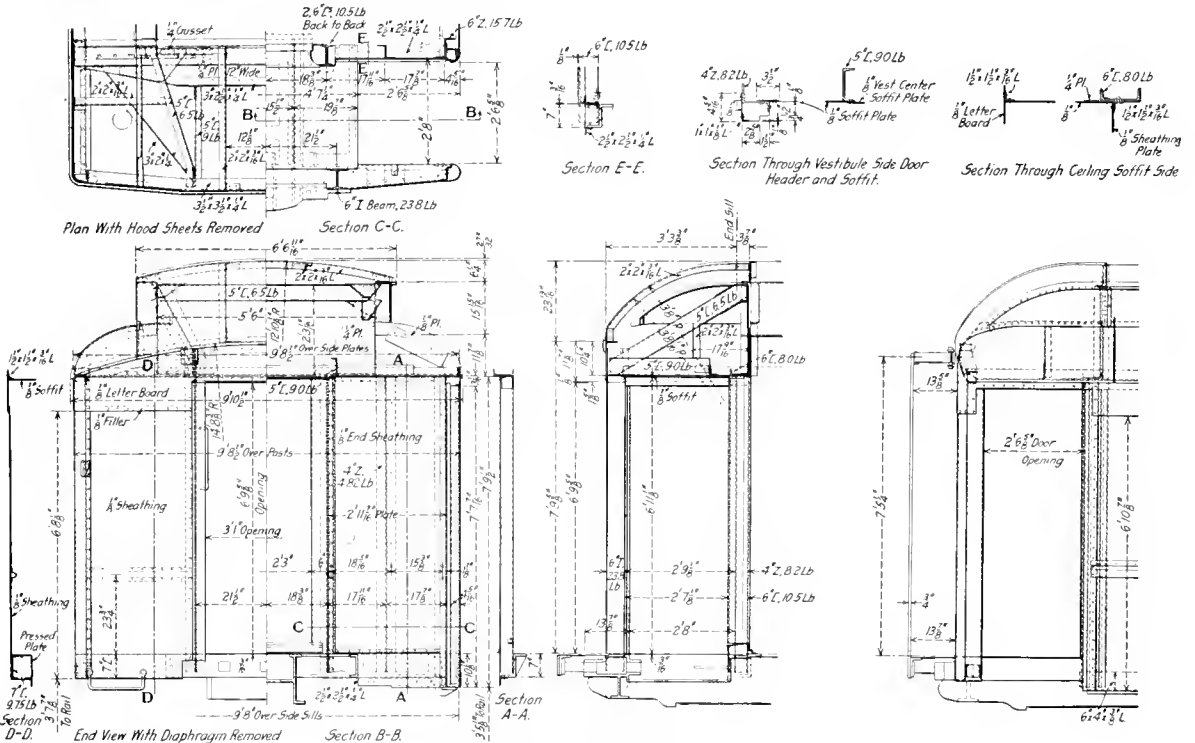

End Framing and Vestibule Details

repeated. Midway between the carlines are placed 2-in. by 2-in. by 3/16-in. angle iron roof supports.

In the framing at the end of the body, structural shapes are used, the corner posts being 6-in. Z-bars, weighing 15.7 lb. per ft., while each door post is formed of two 6-in. chan-

The end posts and corner posts are fastened at the top to a 6-in. channel, to the inside flange of which the bulkhead plate is attached. A 5-in. channel extends between the end deck posts. The buffer beam is a built-up member, supported by the platform casting, the outside being formed of a 7-in.

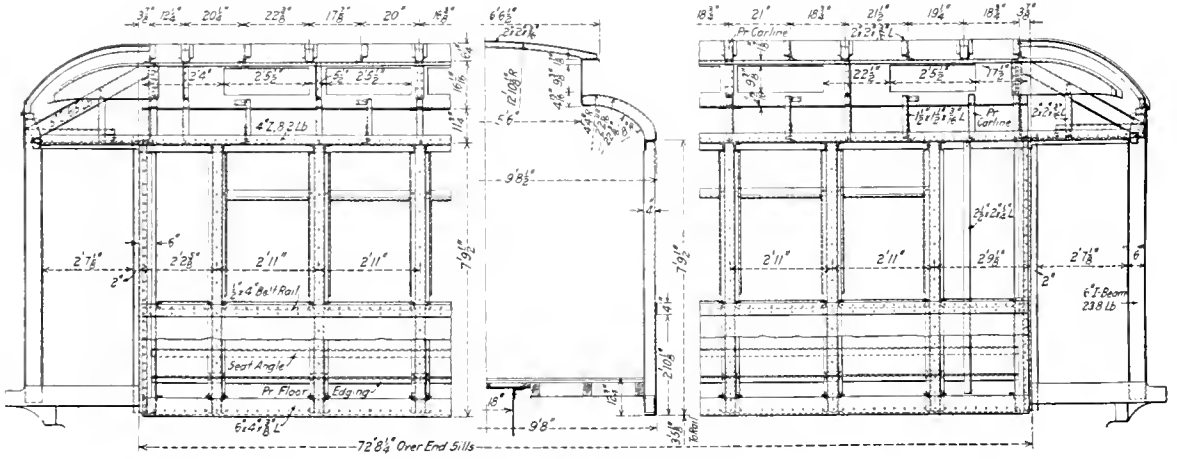

Side Framing of the D. & H. Coaches

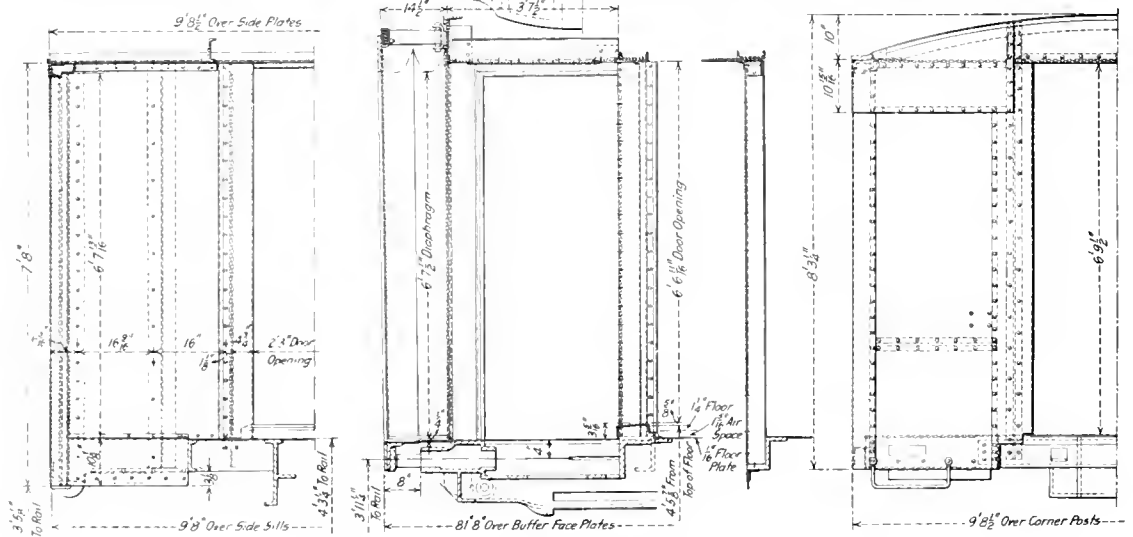
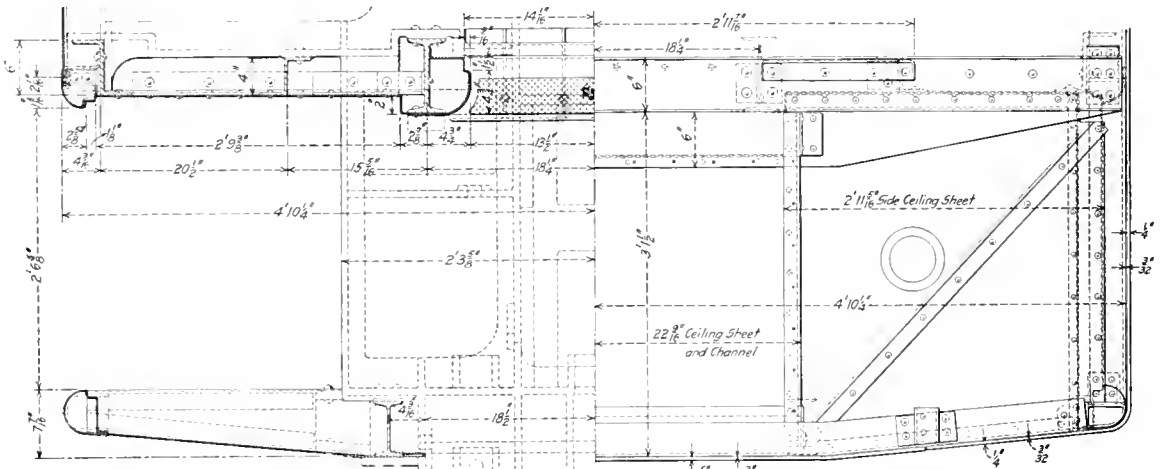

Details of Vestibule of the D. & H. Coaches

channel. The vestibule corner posts are Z-bars, while at each side of the end door opening, 6-in. I-beams of special section, weighing 23.8 lb. per ft. are used. To the upper end of each of these posts are fastened two channels of 5-in.

of the coaches 3-ply Linofelt has been used. The flooring is of Flexolith cement, laid over Chanarch flooring, the color matching the lower sides of the coach. The interior of the coaches is finished in imitation of grained mahogany, with green Agasote headlining in nine coaches and gray Agasote in nine coaches. The seats, except in the Pullman smoking room, are the Walkover type, made by the Hale & Kilburn Company, covered with "Chase" plain green plush seat covering in the coach end, and Pantasote in the smoking compartment. The seats in the Pullman smoker are known as the English type, covered with Spanish leather.

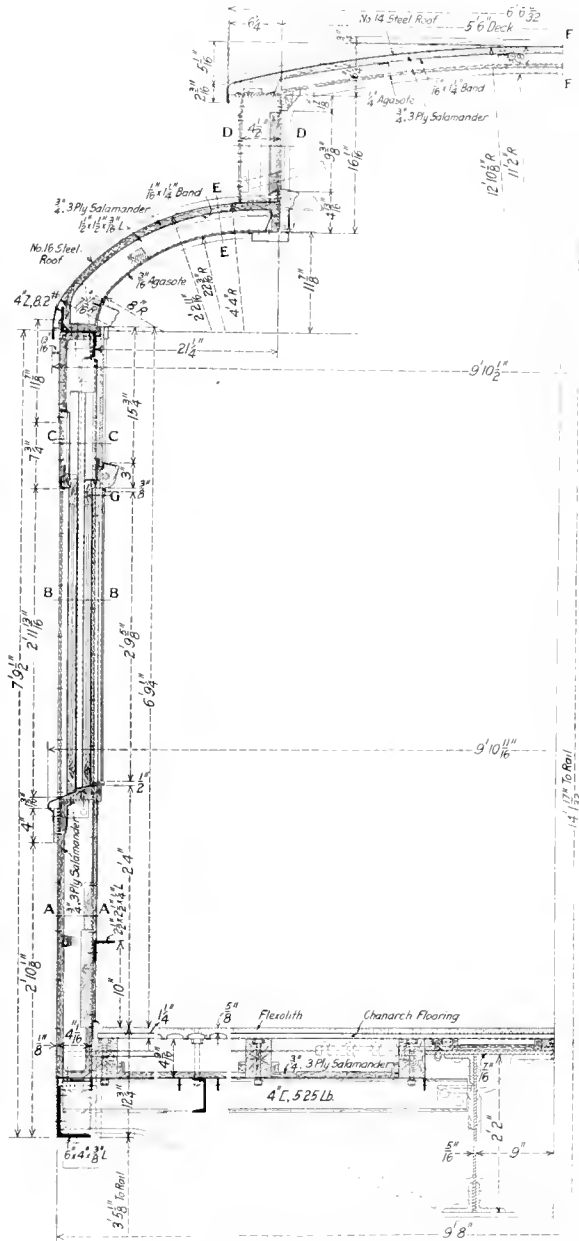

Cross-section of the Steel Coaches

sections, one connected to an angle iron riveted to a stiffening plate which extends across the body end posts, the other extending up to the deck plate. The posts and the side plate are joined by 3-in. by 2-in. angle irons; light angle irons support the vestibule ceiling and 2-in. angles form the framing for the end of the upper deck.

The side and end sheathing is 1/8-in. thick. The upper deck roof sheets are of No. 14 sheet steel and the lower deck roof of No. 16 sheet steel, both having welded joints. The insulation in 15 of the coaches is 3-ply 3/4-in. Salamander, which is held in position by spring steel bands. In three

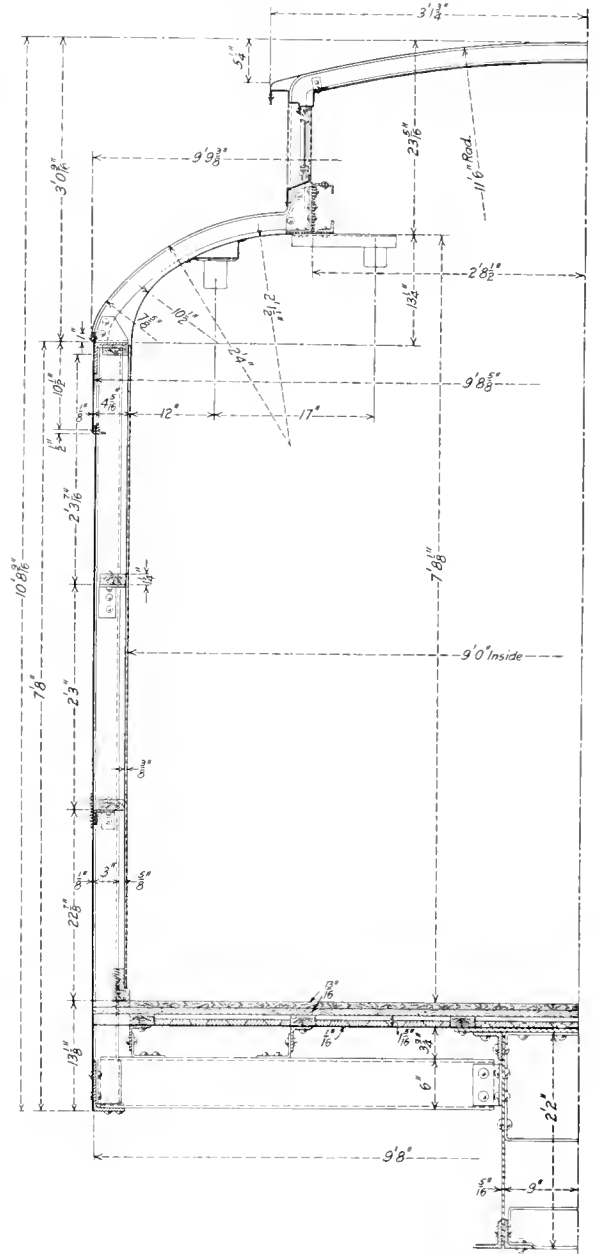

Cross-section of the Delaware & Hudson Baggage Car

The baggage cars are similar in general design to the coaches, except that Z-bars have been used for the side posts, instead of pressed steel shapes. The interior finish of the baggage cars is steel, the color conforming to the require-

ments of the Post Office Department. Double wood floors have been used and the insulation is 3-ply, No. 3 Linofelt. These cars have fresh air inlets opening behind the steam pipe at both sides and ends of the car.

Standard type. The window fixtures were supplied by the O. M. Edwards Co. The draft gear on all the cars is the Miner friction, type A-3-P with Sharon quadruple shear couplers. The buffer is the Miner friction type B-10. West-

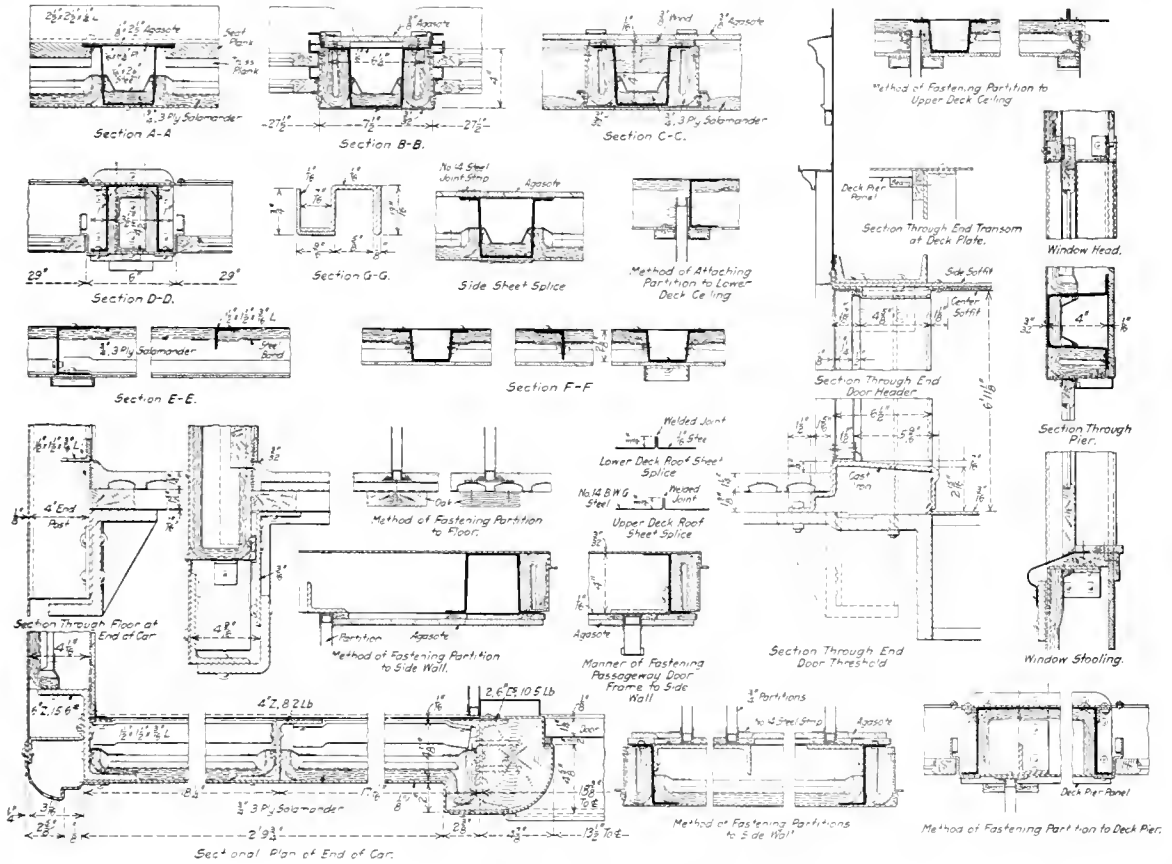

Details of Body Construction

The heating equipment in 19 of the cars is the Consolidated Car Heating Company's thermo vapor system, with direct acting steam car thermostat, while five cars have the Chicago Car Heating Company's vapor system. The Safety

inghouse type P S brake equipment is used with one 18-in. by 20-in. brake cylinder.

The coaches are carried on steel 6-wheel trucks, with 5-in. by 9-in. journals, and fitted with clasp brakes. The bolsters

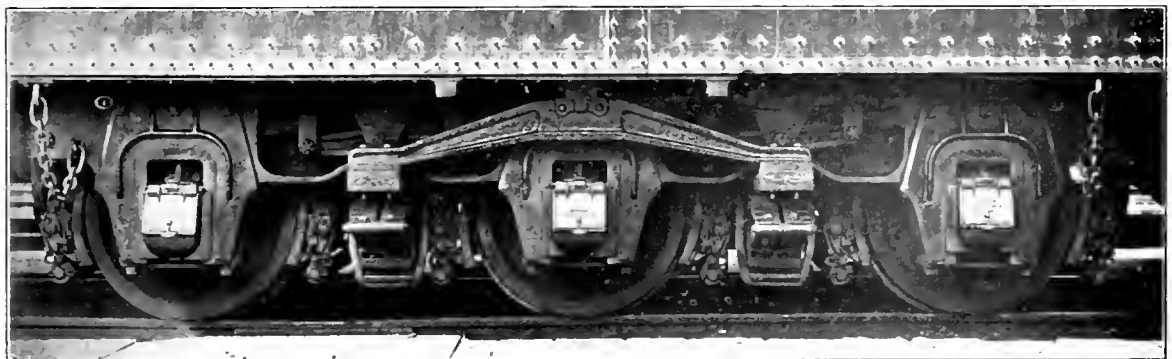

The Six-Wheel Truck

Car Heating & Lighting Company's underframe type electric light equipment has been applied to 18 cars, while the other six cars have Stone-Franklin underframe type electric light equipment. The coaches have the Garland exhaust ventilators, while the baggage cars are equipped with the

are carried on full elliptical springs of the usual type. The equalization system consists of semi-elliptical springs placed over the boxes and connected through short center pivoted cast-steel equalizers. The baggage cars are carried on 4-wheel trucks with 6-in. by 11-in. journals.

Shop Practice

A FURNACE FOR CASEHARDENING WITH CYANIDE

BY E. T. SPIDY

The number of parts which must be casehardened in a railroad shop is so great that any system which would reduce the time required by the old bone pack method and yet enable the work to be turned out in quantities would be useful.

The cyanide casehardening furnace, described in the following, requires that the material be inserted for between 30 minutes and one hour, according to the depth of hardening desired, and the results are as good as those obtained by the bone pack method.

The furnace consists essentially of a cast iron box, which is set into a chamber lined with firebrick. The interior shape of the lining follows the outline of the cast iron pot, leaving a space 5 in. wide all around it, to allow the flame from the

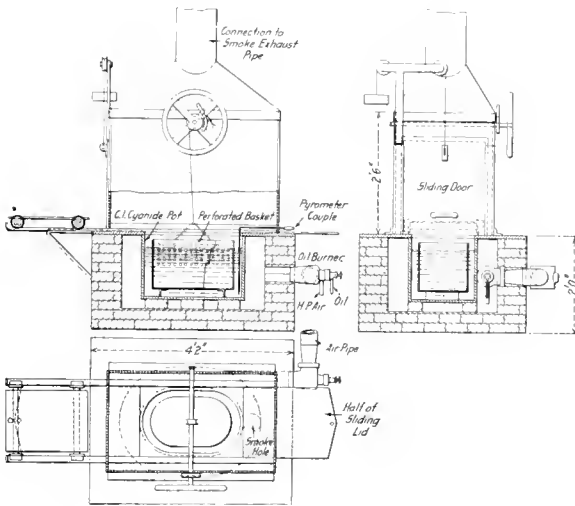

Furnace for Cyanide Hardening Which Protects the Operator from Fumes

oil burner to circulate completely around it. The casing for the bricks is of cast iron, with a top plate made in two pieces so as to facilitate rebricking when necessary. A fuel oil burner is inserted in one corner, the flame being directed around and underneath the box. The box is half filled with cyanide of potassium, which becomes a liquid on being heated. The articles to be hardened are placed in a perforated cage made of 1/8-in. steel plate and lowered into the melted cyanide by means of the pulley and handwheel, attached through the hood. It must be borne in mind that cyanide gases are poisonous and need to be carefully guided away from the operator. In this design the top of the hood is connected to the smoke exhaust system, which amply takes care of the fumes.

By reference to the drawing it will be seen that there is a trolley and track placed on top of the furnace proper. When loading, the perforated cage stands on the trolley outside the hood, with the sliding front door of the hood closed. The

articles are placed in this box in such a manner that the cyanide will reach only the parts required to be hardened. Thus, pins are stood on blocks so that the thread does not enter the cyanide (the height of the cyanide can be readily noted from the discoloration line on the cage).

When the perforated cage is fully loaded, the front sliding door is raised and the trolley pushed into the hood till the hook of the lifting cable engages the handle of the cage. The handwheel outside is now turned until the cable raises the cage and contents, which are then held in suspension by the ratchet and pawl on the handwheel shaft. The trolley is next pulled out and the front sliding hood door closed. Then the sliding doors between the rails on the top plate, which cover the top of the cyanide pot itself, are opened and by means of the handwheel the cage is lowered into the melted cyanide. After the specified time of immersion, the proceedings are reversed and the articles removed and plunged into cold water. It will be seen that this method is absolutely safe for the worker, inasmuch as he cannot possibly come into contact with the gases.

The method is entirely successful and effects a marked saving over the bone pack method or systems by which the articles are treated piece by piece. By adding about one pound of new cyanide per day, the total amount in the box remains about constant.

SAND BLAST FOR CLEANING FLUE SHEETS

BY M. K.

The necessity of thoroughly cleaning flue sheets before welding with the electric arc has led to the development of a special sand blasting machine for doing the work, which is shown in the illustration.

The reservoir has a capacity of about 100 lb. of sand and

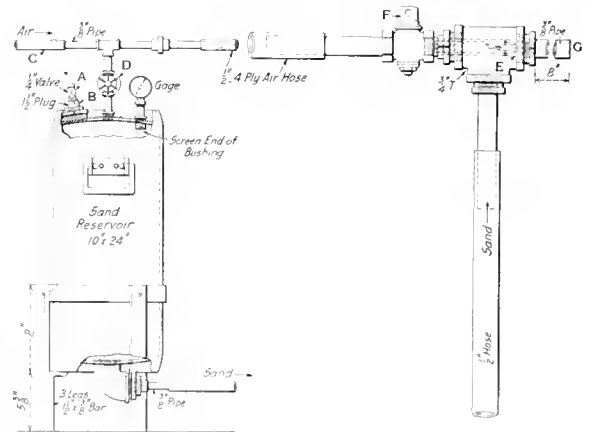

A Handy Sand Blasting Apparatus

is fitted at the top with an air gage, an inlet valve *D*, an exhaust valve *A* and a filling plug *B*. A two-in. Street ell in the lower head serves as an outlet for the sand. The

nozzle, which imparts velocity to the sand is made of $\frac{1}{4}$ -in. pipe, with the end from which the air escapes drawn down to an internal diameter of $\frac{1}{4}$ in. The sand used should be passed through a No. 8 sieve and should be free from dust.

The method of using the device is as follows: The valve *A* is opened to relieve any pressure on the reservoir and the plug *B* is removed. The reservoir is then filled with sand, the plug replaced and the valve *A* closed. The hose *C* is attached to the air supply line and valve *D* opened, admitting 5-lb. pressure to the reservoir, which is sufficient to force sand to the point *E*. The valve *D* is then closed and valve *F* opened, sand being forced through the nozzle *G* against the flue sheet. To stop the apparatus it is only necessary to close the valve *F* and open the valve *A*, relieving the pressure in the reservoir.

The entire apparatus is placed in the firebox when in use. While using this device the workman is protected by a canvas hood with a mica window and also by a respirator.

THE EFFICIENCY ENGINEER?

BY GULF

[The following incidents are true, and happened not many years ago. For very good reasons they were withheld from print, but may now be released.—Editor.]

I am not an efficiency engineer, nor the son of an efficiency engineer, though, like most men, I flatter myself that I know something of efficiency and a little of engineering, but much less in proportion to what there is to be known than I once thought. For a great many years it has been my practice to visit railway shops to study their methods and, sometimes to make recommendations. I do not think that I ever entered a shop in which, at the end of the first half day, I did not have a list of scores of things that seemed to demand an immediate revolution. Many of the practices I found were so bad, so left-handed, such blatant evidences of inefficiency, that I often wondered how the man, or men, who were responsible for them could hold their jobs. Sometimes the list increased in length during the second half day, sometimes it fell off, oftener it remained stationary. The second day I usually began to see clearer and reasons appeared for the left-handedness and seemingly awkward inefficiency. The longer I stayed and the closer I looked, the more apparent the reasons and the less in need of a revolution did things seem; at the end of a week my formidable list of the first half day had usually dwindled to nothing, or nearly so, and I felt like taking off my hat to the men in charge for accomplishing what they did. Rank inefficiency in one place may be a model of efficiency in another, because of the change in local conditions, it is useless to try to recommend changes until all of the local conditions have been studied and learned. Perhaps efficiency engineers do this, I don't know, but a mighty good rule to follow in studying a shop is to ask questions and make no suggestions, at least not until the stock of questions is exhausted, and then it won't take long to make the suggestions, because usually there will be so few of them.

* * * *

Of course, nothing is ever as well done as it might be under ideal conditions, with perfect men and perfect machines, but this combination has not yet crossed my path, and so I pin my faith to the men who are making bricks without straw, and getting good results out of the materials available. It is always well to remember that suggestions are easily made and the less a man knows of prevailing conditions, the more prolific will be his capacity to make suggestions. This is purely a statement of personal capacity and may not apply to the sublimated capabilities of professional suggestors, but I think it will hold fairly true for the ordinary man whose mind works along the ordinary

channels followed by his fellows of a fair average intelligence.

* * * *

Speaking of efficiency men leads me to consider some of their ways. I believe there has been some comment as to their want of tact. Here is a true tale. A railway had a big undertaking on its hands and had a big man to undertake it. Certain plans were approved by the executive and urged by his subordinates as being just about the proper things to follow. But the big man, who was not too big to scrutinize details, suggested certain changes that reduced the cost of execution by just the snug little sum of \$451,000. The revised plan was executed and when put in operation worked satisfactorily and with ever increasing economy. But the efficiency engineers by the score began to tell the president that they could save no end of dollars by reorganization, and they persisted so in their importunities that he, the president, came to think that there must be a lot in it because they all said so. So he engaged a group of seven of them to look into the details of the work of this big man, and some of the other big men on the line. It was a tough job, because a big man is usually an efficient man and things looked hard for the professional efficiency men. It was hard for them even to suggest improvements, but like labor leaders they had to do something to hold their jobs. So the chief of the whole crowd, with a big reputation, went out one night with one of his stop-watch assistants, and in prowling around the cinder pit between one and two o'clock in the morning, when work was slack and there were no engines to be cleaned, but the men had to be there, found four "Hunkies" apparently asleep. Quietly they set up the camera and, flash!—a picture was taken of the delinquent four. The flash aroused the four, and the two efficiency men fled for their lives. But the picture went to the president to show him how the big man's efficiency could be improved. Wonderful, wasn't it?

* * * *

Somewhere I have read of a question as to the honesty of this new breed of interlopers. For example, in a big plant a foundry was built. It was a good one and well designed. But after it was placed in operation, the superintendent scrutinized the cupola and felt that it could be improved. So he called in experts and they, including the builders of the cupola, concluded that better results would be obtained if it were to be lowered 36 inches. Plans were made to make the change; but it isn't easy to make such a change when there is a demand for castings, and there is a melt every day. Meanwhile the efficiency men were hot on the trail and eager to justify their existence by a suggestion. One of them was in the foundry with a stop-watch keeping tab on the time one of the men was spending in the toilet, when the foreman incidentally remarked that it was the intention to improve the cupola by lowering it 36 in. Ah, ah! there you are! The next day a report was rendered to the president stating that the present cupola was very inefficient and that it would be greatly improved by being lowered 36 in. Honest, isn't it? If it is, then Heaven guard us from the honest man.

* * * *

By the way, there is an interesting sequel to the sleeping "Hunkies." One of the same lot of efficiency men was detailed to watch the coal consumption on a certain engine test. He was to keep track of all local conditions and be on the engine at all times. A railway officer who was not an efficiency man, happening around and wanting to go where the train was going, took to the caboose and there, comfortably wrapped up on one of the bunks and snoring soundly was the efficiency man who was supposed to be an alert of the alerts and on the locomotive. He was employed by the very man who photographed the sleeping

Hunkies. Ah, woe is me when such tales are told of the very elect. But the question arises, who was the more inefficient, the Hunkey at \$1.50 per day who *seemed* to sleep when there was nothing to do, or the efficiency man at ten times the Hunkey's rate who *was* asleep when he was paid for being wide awake and very alert?

* * * *

One more story of the efficiency man and I am through. After taking photographs of the tops of every tender on the line and ascertaining that there were three brooms and two shovels going to waste at a cost of two dollars, in exchange for the forty that it cost to photograph them, they tackled the aprons between the tenders and locomotives as a fruitful source of waste and inefficiency. They photographed them every one and measured the diameter of every hole and the width of every crack that existed in all these aprons, and then made an estimate of the amount of coal that could be lost through these manifold openings. Each hole and crack was credited with its own quota of the number of ounces of coal per minute that would sift through. It was frightful, it was terrific, it was a waste of unparalleled immensity. Stop and consider. Hundreds of locomotives, each with one or more streams of pure coal, coal containing 14,500 B. t. u. per pound, flowing through the aprons. Did the president "trun a fit?" Did the coal agent sit up all night? I don't know, but they ought to have done so if they didn't; for when the figures, authentic figures of the efficiency men, mind you, were sent to the superintendent of motive power he took notice and a pencil, and the result of this combination of notice and pencil was that in about two minutes—you see, he had to be efficient now, to stop the waste—he learned that in a year this awful waste of coal that had been certified to by the efficiency men had covered, or ought to have covered, the whole four hundred miles of the road with this precious coal to a depth of 11 ft. I haven't heard as to whether he wired his results to the president and asked for a special appropriation for rotary snow ploys to dig the road out, or whether from sheer chagrin at the discovery of their own inefficiency all hands were silent and let the grass grow and the tracks lie on this bed of coal, knowing that it was there and available for instant use whenever the present supply may fail.

By the way, I forgot to mention that after the photographing of the Hunkies and the disclosure of the leaky aprons, the big man who cut a half million off his shop costs and whose figures for locomotive repairs are the envy of his fellows, decided that he had had enough and resigned, and I am wondering what the road has gained by the transaction as a whole.

* * * *

These, to be sure, are trifles, little things, mere incidents in the all-embracing scheme of economy and efficiency. If ever there were a lot of men who dwelt in magnificent generalities and equally magnificent figures, it is the efficiency men, who save from \$1,000,000 a day down, and who think they can prove anything. But really doesn't the efficiency man fill Josh Billings' definition of an enthusiast? "An enthusiast," says Josh, "is a man who can prove ten times as much as anybody will believe and believes ten times as much as he can prove." Then why, if they can do so much, why photograph a sleeping Hunkey?

* * * *

To the onlooker, the man in the street who thinks and discriminates, it seems strange, and the strangeness makes it seem impossible, that butchers and bakers and candlestick makers, to say nothing of lawyers, are so very much more wise and capable and honest than the men who have worked their way to the top by dint of hard labor and despite hard knocks; that they, without any very intimate acquaintanceship with details, can tell the men in charge

how to do their work all along the line. To me it doesn't look altogether reasonable and I merely ask, is it?

TURNING BOLTS IN A BOLT CUTTER

BY ARTHUR J. HUMPHREY

An arrangement of a double-head bolt cutter which has effected a considerable saving in the making of fitted bolts is shown in the illustration. The left hand carriage of the machine has been fitted with a feed screw geared to the main driving gear and in the die head are threading dies which have had the threads ground off and the outer corners rounded for a cutting edge, thus making an effective turning head. The right hand head has the standard threading die.

The frame bolts, saddle bolts, etc., are forged in quantities, of various lengths and sizes, and are brought to the special bolt cutter, where a helper turns the ends to the proper size in the left hand head and threads them in the right. After setting the heads to the proper sizes and the stops to open

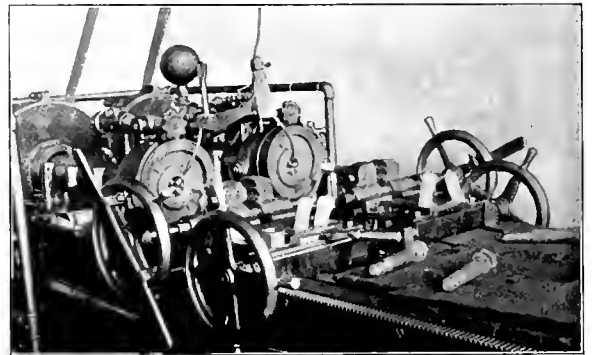

Double-Head Bolt Cutter Which Turns and Threads Ends of Fitted Bolts

for the desired length of cut, the bolts can be threaded rapidly as the operation is performed with a minimum amount of handling.

The threaded bolts are kept in stock and when they are needed it is only necessary to screw a hollow threaded center over the end of the bolt, catch the head in the lathe chuck and turn the bolts to the proper size.

The single head machines will do the same work, but of course the dies must be changed and more handling of the bolts is necessary. With this special arrangement a helper and a bolt cutter will produce as much and as good work as an expensive automatic turret lathe operated by a skilled machinist.

PNEUMATIC CARRIER

BY M. K.

Pneumatic carriers for conveying messages from one point to another are being used with success in many railroad shops and terminals. A simple arrangement of conveyor and receiver which can be made at any shop is shown in the sketch. The pipe line, which is placed underground, is made of 2½-in. wrought iron pipe. The brass collar on the end of the pipe is held in place by a jamb nut. The interrupted thread holds the cap, which can be tightly clamped by a slight twist that causes the lugs to grip the thread. Air from a compressed air line is carried to a conveniently located stop cock, which is connected through rubber hose to the cap.

The case in which the messages are transported consists of two leather cylinders, one of which fits inside the other, the body of the outer cylinder being somewhat smaller than

the inside diameter of the pipe, but having a base which is a fairly close fit in the tube. The receiver, which is placed in line with the end of the pipe and catches the carriers, has a small hole in the closed end to eliminate rebound of the case. When the carrier is not in use, the cap is placed to one side. When a message is to be sent the carrier is inserted, the cap put in place and the stop cock opened. After sufficient time

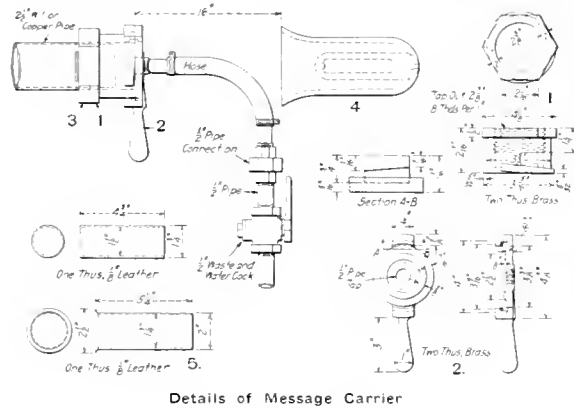

Details of Message Carrier

has elapsed for the message to reach the other end of the line (one to two minutes), the air is turned off and the cap removed. The chief application of the carrier system has been in sending reports from the inspection pit to the roundhouse office, but there are numerous other uses to which the device may be put.

PROLONGING THE LIFE OF FIREBOXES

BY DANIEL CLEARY
San Antonio & Aransas Pass, San Antonio, Texas

Boilers are like men. They have to be given the proper care if long life and useful service are to be gotten out of them. Locomotives all have feed pipes that deliver water from the injector, somewhere near the surface of the water in the boiler. This is for the definite purpose of heating and mixing the comparatively cold water from the injector with the hot water in the boiler as much as possible. If cold water were run in at the bottom, being heavier for a given volume than warm water, the chances are it would lie there, cutting down the circulation and causing unequal expansion in the sheets.

What is the general practice in the average roundhouse with regard to filling boilers? An engine comes in the house and stands around for an hour or so. Some light running repairs are in progress, when along comes an order for an engine as soon as possible. The fire-up man is told to "fire her up at once." He climbs up and looks at the glass and tries the gage cock, but can't find any water. This is only natural as it has been standing around some time after the fire was knocked out. The engine is wanted in a hurry and the fire-up man knows that he must get it out so he tells the boiler washer to "fill her up through the blow-off cock."

There can be but one result from such treatment. Did you ever notice firebox sheets cracked opposite the blow-off cocks? The next time you see cracks in this location, look around and see how the boilers are being filled.

A period of 10 to 14 months of filling with cold water through the blow-off cocks will crack sheets so they will need plugging for cracks from 1/2 in. to 1 1/2 in. long, whereas if the boiler were filled in the proper way, it would run for five or six years under fair water conditions. Oil-burning locomotives especially should be guarded closely when washing and filling, as it takes from 10 to 12 hours for the brick work to cool.

Frequently washout plugs are found on the bottom of the boiler shell about 10 in. from the front flue sheet. This has always been an eyesore to the writer. The boiler washer puts his nozzle in this hole and ties it to the brake cylinder or some other convenient location and lets the water run and as the water is running in but one direction, it merely cleans out a narrow path so that eventually it is necessary to take out 15 or 20 tubes to wash mud from the bottom of the shell. A belly washout plug like this should be patched and washout holes put in on the right and left side of the boiler above the guides; then the boiler washer may stand outside where he can hold the nozzle and throw the water all over the bottom of the shell. Anyone who has ever had the job of tapping out a boiler plug hole in this location will agree that it is a job that will try the patience of a saint.

Where it is the practice to use cold water for boiler washing or water but slightly heated from a small steam pipe leading into the washout nozzle, the boiler washers and others filling boilers get careless and do not realize the damage they do to the fireboxes. As the damage does not show up right away, they give in to the pressure of getting engines back to work in a hurry. The only safe way to hurry up boiler washing is to use a hot water boiler washing and filling system. The boilers can then be cooled down, not too rapidly, through the feed pipes, but washed out and refilled with hot water, hurrying the job along about as fast as possible.

A TOOL FOR FORMING ROD BUSHINGS

BY H. C. GILLESPIE

The lathe tool shown below has been designed especially for turning rod bushings and is so constructed that it fits in the carriage of the lathe instead of in the tool post. The

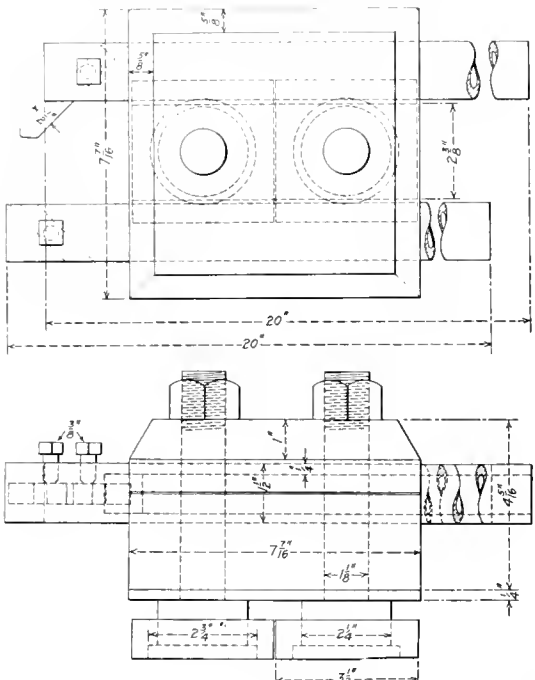

Tool Which Bores and Turns Rod Bushings in One Operation

holder carries two bars with inserted cutters held by set screws. By using this device and finishing the inside and outside of bushings at the same time, the work is performed nearly twice as fast as when a single tool is used.

SOME INFORMATION ON ARC WELDING

The Effect of Varying Current on the Structure of the Weld, and Efficiency of Heat Utilization

BY F. G. DE SAUSSURE
Engineer, Siemund-Wenzel Electric Welding Co.

THE primary object of welding is to join together or repair parts that require strength, and therefore a question of prime importance is: How strong is a joint made by the electric welding process? In answering the question it must first be assumed that the weld is to be machined to the original section, for it is evident that by the method of reinforcing, welds can be produced that are stronger than the parts joined,

The welding material itself is clearly shown in Fig. 3. The section was taken from the position indicated by the circle on the adjacent sketch, and a very distinct line marks the joining of the added metal to the original. The very dark patches indicate the presence of oxides, which results in a poor weld, as there is practically no adherence between the original and the weld when the oxide is present. This sample was made with a current of between 90 and 100 amperes and the oxide is undoubtedly the result of too low current and therefore insufficient heat used in the process.

Increasing the current results in a better weld, illustrated in Fig. 4, which was made with a current of about 125 amperes. Note that the oxide patches have diminished in size to small particles. The metal adjacent to the weld still possesses the laminated structure as was noted in Fig. 2, indicating that the heat was not great enough to harm the metal.

Still better results are shown in Fig. 5, and it is now hard

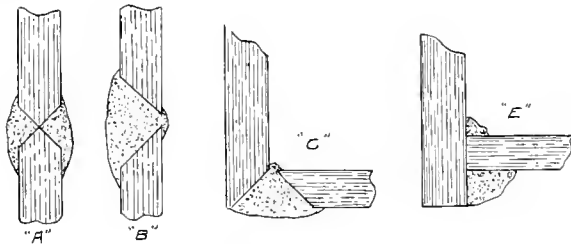

Fig. 1

merely by virtue of increased cross-section. The results of two hundred specimens show the following average results in pounds per square inch:

	Original.	Welded.
Elastic limit	46,900	45,600
Ultimate strength	61,500	48,585

The above specimens were bars of 1½-in. by ⅜-in. structural steel gripped 18 in. apart. The pieces to be welded were beveled on both sides as shown in Fig. 1.

STRUCTURE OF WELDED JOINTS

Sample cross-sections cut from test pieces electrically welded were magnified and photographed, and show the following characteristics:

In Fig. 2, A, a section of the metal entirely remote from

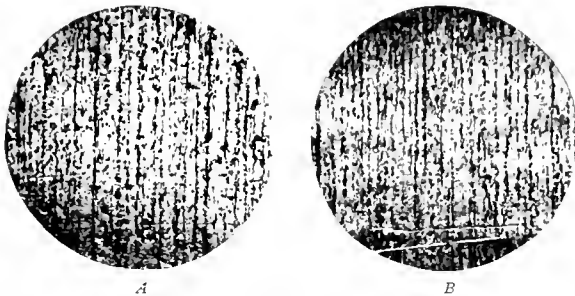

Fig. 2A—Section Through Test Piece at a Point Unaffected by the Heat

Fig. 2B—Metal of the Piece Where Affected by the Heat

the joint was taken, and shows the natural "grain" of the iron; this should form the basis for comparison, as it has not been subject to the action of the arc. The effect of the heat will be seen by a careful inspection of B in the same figure. The more pronounced darkened laminations show the pearlite more distinctly, but there is no indication that the material has been overheated. The pearlite areas show the effect of the heat, but the arrangement may have been caused by the gradual annealing of the metal as it cooled after the weld.

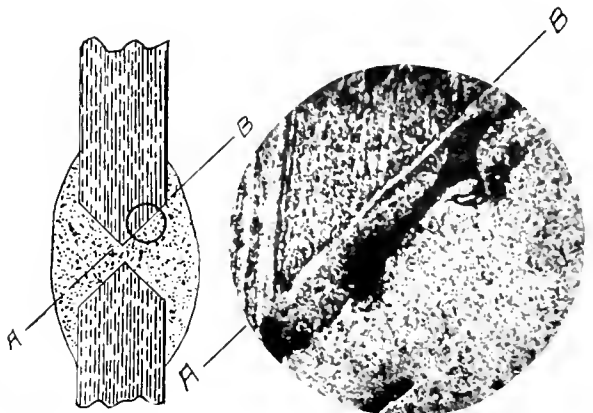

Fig. 3—Section of a Weld Showing the Effect of Too Low Current

to distinguish between the added metal and the original. This sample was made with a current between 150 and 160 amperes, and is perfect. The original metal, it should be noted, has now given up some of its laminated structure and therefore a point has been reached where a further increase of current will burn the metal.

EFFICIENCY OF HEAT UTILIZATION

It may be of some interest to calculate the heat efficiency of the process. A current of 155 amperes at 20 volts liberates 3,100 watt-hours per hour; this is equal to 3,100 times 3,412=10,577 B. t. u. per hour liberated at the arc. A fair rate of use of welding metal is two pounds per hour, which is raised to a temperature of 3,900 deg. C., this being the temperature at the positive side of an arc. This is equivalent to 7,052 deg. F., or 6,982 deg. above room temperature (70 deg.) which, multiplied by the specific heat of iron, 0.1165, gives 813 B. t. u. per pound, or 1,626 for the two pounds used per hour, to which should be added the latent heat of fusion for two pounds of iron, 109 B. t. u., giving 1,735 B. t. u. required to fuse the two pounds of iron and raise it to 3,900 deg. C. We have shown that the energy actually expended at the arc was 10,577 B. t. u., so the thermal efficiency of the process

is $1,735 \div 10,577 = 16$ per cent. This may seem rather low, but it is far higher than the efficiency of the gas weld process, which is in turn much greater than that of a blacksmith's forge.

Starting with the electrode and work cool, it is reasonable to say that the heat should be supplied at a greater rate than when the weld is in progress. However, the time required is so short that this item may be disregarded. The length and resistance of the arc vary continually, owing to unavoidable motion of the electrode, and it is important to maintain a steady current in spite of such fluctuations, to insure the temperature remaining sufficiently high to obtain perfect fusion; otherwise some particles may pass over burned, while still others will not be at the fusion temperature, producing a weld of uncertain quality, as shown in Fig. 3, previously discussed.

Probably due to the fact that the carbon arc has been longer in use and is more easily investigated, comparatively little is known of the metallic arc. One of the most striking features of the metallic arc as used for welding is that the deposit of metal is opposed to the flow of current; the operator holding the negative electrode while the positive wire is attached to the work. The reason for this is that most of the heat of an arc is generated at the positive pole. A study of Fig. 6 will more fully illustrate the relationship. The pencil electrode being of far less mass than the piece being worked on, less heat is required to bring it to fusion, consequently a good distribution of heat is obtained by making it the negative pole.

The apparent length of the arc, as viewed through the welding glasses, is $\frac{1}{3}$ to 3-16 in., but by referring to Fig. 6 it will be noted that the molten terminals of the arc glow to such an extent that they appear to be parts of the arc itself. There is a continuous flow of molten particles from the pencil to the work, producing a metallized air gap which, when the arc is projected upon a screen, shows interesting results; it moves about, always taking the path of least resistance, and its color spectrum indicates that practically every substance coming under its influence is instantly volatilized.

EFFECTS OF THE LIGHT

The brilliance of the light and the prominence of actinic rays renders the arc highly injurious to the eyes if they are not properly protected. That a careful operator's eyes are

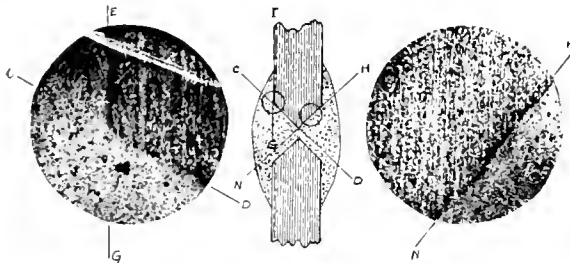

Fig. 4—Sections of a Weld Made with 125 Amperes

not affected by the light as viewed through a welding shield is evidenced by the fact that men who have done such work for years do not seem to suffer any ill results. The careless operator, usually a beginner, suffers painful effects from "flashes" caused by drawing the arc without having a shield over the eyes. A good remedy for such an injury is the application of hot tea leaves with a few drops of witch-hazel on a bandage over the eyes; also wash them with a mild solution of boracic acid.

It is a mistake to use a shield having too light colored glass; one result is that the operator's eyes become fatigued due to the brilliance of the light, and he continually draws a

longer arc without realizing it. The glasses should be of such density that sunlight is barely visible through them. Two red and one green glass make a good combination.

The operator soon learns that exposed skin is acted on by the light in a manner similar to sunburn, but much more rapidly, the exposed part blistering and peeling after a few minutes of exposure. He should not only be careful of himself in that respect, but should caution any other person within range to keep his sleeves rolled down and his wrists covered.

RATE OF WELDING

Welding is usually accomplished more quickly by the electric arc than by any other process and we give here some examples for illustration:

A full set of locomotive flues, 36 superheater and 256 $2\frac{1}{4}$ -in. flues have been welded in 12 hours and 30 min. by

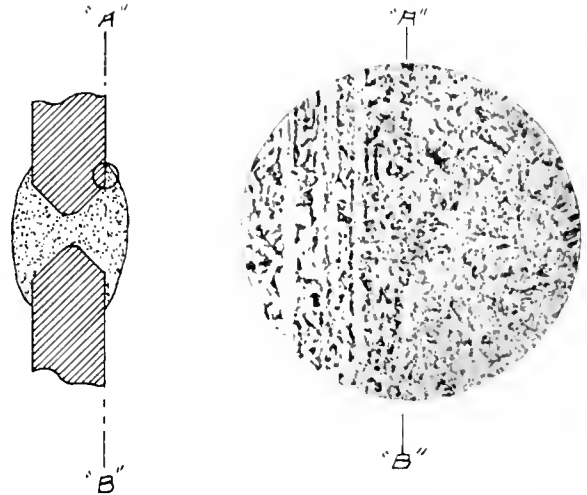

Fig. 5—Section of a Weld Made with a Current Between 150 and 160 Amperes

one operator. The 36 superheater flues were completed in three hours, or at the rate of 12 an hour. The 256 boiler flues were welded in 9 hrs. and 8 min., or at the rate of 27 per hour. Twelve leaks developed and required 20 min. to reweld. On the superheater flues 175 amperes were used with 20 volts at the arc, using 5-32-in. electrodes. On the smaller flues a $\frac{1}{8}$ -in. electrode and 125 amperes were used with 20 volts at the arc.

In a series of tests on $\frac{3}{8}$ -in. boiler plates, an average speed of 2 ft. per hour, on work in a downward position or at the sides, was maintained. On overhead work 1.8 ft. an hour was averaged. Calculations from seven pieces of $\frac{3}{4}$ -in. cast steel showed an average of .83 ft. per hour.

When a welder is at work, his time may be divided into three parts: cleaning, welding and renewing electrodes. Repeated timing indicates that $10\frac{1}{2}$ min. out of every hour is consumed in renewing electrodes and an average of four min. an hour is taken up in the use of the wire brush. The amount of metal deposited in an hour depends largely upon the class of work. To give some idea of this important item, the following table has been compiled:

Class of work.	Amperes.	Lb. of electrode used per hour.
$\frac{3}{8}$ -in. boiler plate, downward.....	135	2.46
$\frac{3}{8}$ -in. boiler plate, overhead.....	140	2.23
$\frac{1}{2}$ -in. cast steel, downward.....	150	3.12
Extra heavy shapes.....	175	3.28

AMOUNT OF METAL REQUIRED

It should be noted, however, that weight of electrodes used does not represent the actual weight of metal applied,

for about 26 per cent is wasted in the stub ends and there is some metal lost in the process. The waste per hundred pounds, based on a price of 6½ cents per pound for electrodes, is \$1.69, minus the scrap value of electrode stubs. At this point, however, a note of warning should be sounded. Burning the electrode too near to the handle is a bad practice, while too long an electrode is also likely to result in a poor weld.

Considerably more metal must be put into a weld than is represented by the volume of the opening between the pieces. The percentage varies with the thickness of the metal. For

NOTES ON ROUNDHOUSE SUPERVISION

BY JOHN F. LONG

An old foreman once told me that the secret of success in handling a roundhouse lay in having "someone responsible for each small detail of the work." The foreman in charge is responsible for the proper performance of the men under him, but he cannot personally follow up each small detail of the entire roundhouse. It is, therefore, essential to detail the smallest operation to someone, giving him instructions on just what are his duties and, above all, being quite sure he understands the results expected.

If care is used in making this clear to a man, he enters into the performance of his assignment with a feeling that he is a party to a big undertaking, not merely filling in the hours of service necessary to earn a few dollars. More is gained by interesting a man in the work than by driving him. We are all human.

The writer spent six months in the Twenty-second Kansas Volunteers in the Spanish American war, a portion of this time being spent on special duty. He was given an opportunity to study from the point of view of a private soldier and a non-commissioned officer, the system of handling the men. The most impressive feature of this system was the obedience to the army regulations. All were thoroughly instructed daily in the regulations and a large per centage fell into a natural habit of obeying them without a thought. The men also expected the officers to enforce the laws. Everyone admires a large body of soldiers drilling, admires the way the men move in unison. There are no loud confusing commands or signs of excitement. This is explained by the fact that each individual knows exactly what is expected of him, as do the officers in charge. In fact, the men become so proficient that a private soldier could suddenly be called from the ranks to perform the duties of an officer.

Another outstanding feature of the army organization is the abundance of supervision. In a company of over 100 men, one soldier out of each eight is a non-commissioned officer who is assigned various duties and responsibilities and given a few dollars more than the private soldier. This does not weaken the company in any way, as these men carry the same kind of equipment, march in the same files with the soldiers and shoot just as fast. From this an object lesson can be drawn: ample supervision without weakening the ranks.

A foreman who assigns himself to the duty of being responsible for each small movement in the roundhouse, thereby educating his men to wait on him for instructions before making a move, makes a miserable failure of the job and lives in an atmosphere of trouble and delays. Rather educate the men each day to be more self-reliant. Then the work will move with precision, even though the attention of the foreman is necessarily centered in other directions for hours or days. One officer was heard to remark: "Yes, I visited Blank terminal the other day and I found everything moving off with regularity, the place was clean and tidy, but the thing that impressed me was the fact that the foreman, due to the illness of a member of the family, had been absent from the roundhouse a week."

It need hardly be said that here was a foreman who had taught his men to have confidence in themselves. One foreman was heard to say to his night foreman: "Billy, you have been chosen for the position of night foreman from among your shop-mates because we feel that you will make good. Now, anytime I can do anything for you, remember that I am willing to do it, no matter what it is; but I must work tomorrow and should have rest. Meet any emergency that you may be confronted with during the night, and if in the end it proves that your judgment was wrong, we will talk it over and you will not do it again." Need it be added that this night foreman made good?

What about the day foreman? Well, I heard the superin-

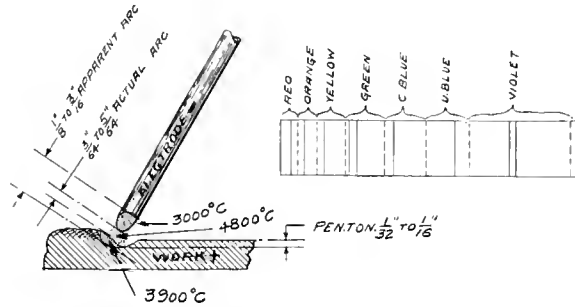

Fig. 6—Conditions Incident to the Use of the Metal Electrode

¾-in. plate add 54 per cent to the volume of the opening but add only 41 per cent for ⅝-in. plates. The following example illustrates the calculation:

Boiler plates ⅝-in. thick with a 4-ft. crack beveled out to 45 deg. on each side and left open ⅛-in. at the bottom as shown in Fig. 7. The total volume of the 4-ft. opening with a cross section as shown in the figure is 8.96 cu. in. This would require 2.56 lb. of steel to fill it, to which must be added 41 per cent, as explained previously, making a total of 3.6 lb., which must be applied. This, however, does not represent the weight of the electrodes used, as 26 per cent is wasted in stub ends; the total weight of electrodes required, allowing for this weight, is 4.54 lb. At the rate of 2 ft. an

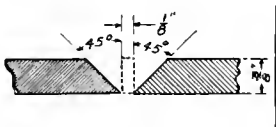

Fig. 7—Plates Prepared for Welding

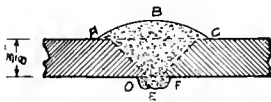

Fig. 8—Welding Completed

hour, given above, the piece should be completed in two hours; and according to the rate given in the table of 2.26 lb. of electrodes per hour, the time required should be 1.84 hours; it will be noted that the figures agree very closely. It is probable, however, that the welding would be somewhat slower than just indicated, as it is doubtful if the operator could maintain such a speed continuously for a period of two hours.

The extra metal required over the volume of the opening can be explained by reference to Fig. 8, which illustrates the completed weld. The segments *A B C* and *D E F* add a large percentage to the estimated volume, and some metal is thrown out in the form of sparks, the percentage wasted being greater on heavy work.

tendent of motive power say he was the best foreman on the system.

Do not construe this to mean that the foreman should turn his back on the details of the work; he should rather dig into the details of the work until the men are trained to the point where they will relieve him of the minor details. This will then give him an opportunity to concentrate his attention on the things which are giving him trouble and delaying the work. One morning a certain shop foreman, feeling that he had everything above possible criticism met the writer in front of one of the machines of the shop and began explaining what a good output he was getting from this machine; machining the product from rough to finished with six operations, completing so many in one day, and wound up by saying, with the air of a man who was perfectly satisfied with himself, "Can you beat it?"

"Yes," I replied, "that certainly looks good, but why don't you double it and cut down the number of operations?" The first important improvement was suggested by the operator of the machine. One officer, on being informed of the small operation eliminated, thought it too small to consider, but it was too late to stop this department; they were aroused, and as a final result this machine today is finishing the same piece in three operations instead of six and the output has been doubled.

METHOD OF MAKING TUBE EXPANDERS

BY F. W. SEELERT

Ordinarily tube expanders are made by turning up a solid blank to the desired shape and then slitting it into sections on the milling machine. At the Soo Line's Shoreham shops in Minneapolis, Minn., these expanders are made from beveled bar stock. Suitable size stock is selected and blocks sawed off as shown at *S* and *T*. These are the blanks with which the operation is started, and they are clamped in the mandrels shown at *C* and *D* and held in place by set screws in an iron ring. After the set screws have been tightened down and the blanks made secure the mandrel is placed between lathe centers and the sections faced off to the correct

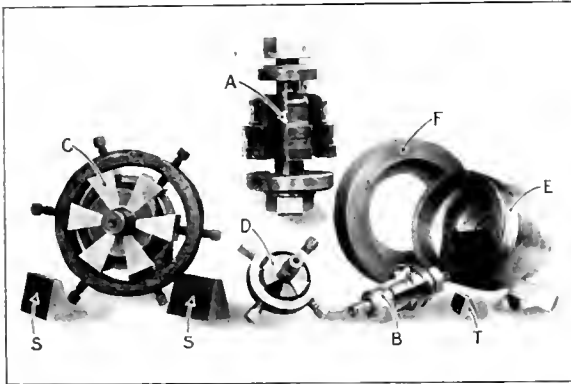

Mandrels Used in Making Tube Expanders

length. For the smaller sizes it is very handy to use a double tool holder for facing both ends at the same time, especially when the expanders are made in large quantities. This insures absolute uniformity in length.

After being faced on the ends, the sections are placed in the mandrels *A* and *B*. The clamps and washers shown at the top and bottom of these mandrels are tightened down to hold the blanks in place. A series of sharp grooves will be noted on the inside face of the washers. These are for the purpose of holding the ends of the blanks in place. This mandrel is put in a lathe and the blanks are turned to the

exact contour of the mandrels. These mandrels are turned from a solid piece of carbon tool steel, the recesses being lotted out of the solid piece to receive the blanks. The mandrel for making superheater expanders has six slots, while the standard tube mandrel has four; each mandrel will, therefore, accommodate half of a set of sections for a finished expander of either kind. After finishing, the mandrels are carefully hardened and drawn. At *E* is shown a cast iron chuck used in holding the section of superheater expanders while they are being bored on the inside to fit the taper expanding pin. The sections are held in the chuck by the clamp ring *F*, which screws on to the thread to be seen on the outside of the chuck. The whole chuck is screwed on the end of a lathe spindle and the taper hole is then drilled and accurately finished to fit a pattern, in order to insure interchangeability of all the sections. This operation is performed on the superheater expanders only. The smaller sizes of expander blocks are finished on the inside on a milling machine, using a suitable jig and radius cutter. After these operations are completed, all that is necessary is to remove the burrs and sharp corners and the sections are ready for hardening.

The saving effected by this method over the old method of turning up a solid blank and slotting is about 68 per cent for small expanders and about 40 per cent for superheater expanders.

DEVICE FOR REBORING DISTRIBUTING VALVES

BY E. S. REARDON

The illustrations show a device for reboring the equalizing chamber of distributing valves, which was designed and built by the writer. The tool bar *E* is carried in a guide and has on one end a swivel nut *B*, which fits over a collar on the end

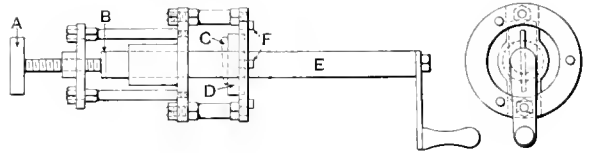

Equalizing Chamber Boring Machine

of the feed screw *A*. The boring tool *B* extends through a slot in the bar and is held by the wedge *C*. When the bar is rotated it is fed as desired by turning the handwheel on the end of the feed screw. The device is held central by the pins

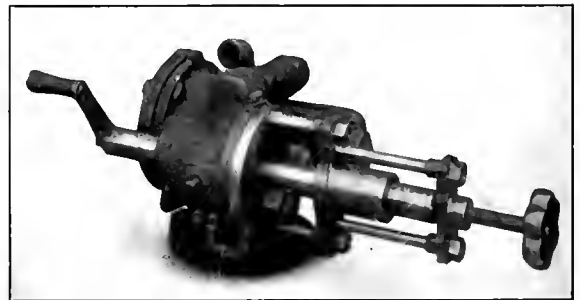

Boring Machine In Position

F and is secured to the distributing valve body by a small *C*-clamp as shown. This device has proved economical in the Rutland shops at Rutland, Vt., and may be found useful elsewhere.

A FOREMAN WHO FIRED HIMSELF

A Story Dealing with the Handling of Men; How
Thomas Carleton Called the Master Mechanic's Bluff

SINCE the days when John McNally had been succeeded by Tom Carleton at the Greenfield roundhouse of the Y. & A. Z. things had been running with increasing smoothness, but today there was an engine off the track in the inner circle. Nothing unusual about this, as once in so often, no matter what roundhouse you visit, you will find an engine off the track in the circle. Engines seem to have a way of climbing the rail as they move off the turntable. The thing that was unusual in this particular instance, and that makes it worth a place in the chronicles of the Greenfield "roundhouse gossip," is that the engine had been off for almost an hour.

No less than 20 men were jumping around the Consolidation on this bright, but cold January day. To an onlooker it seemed as though each man spent most of his time getting out of the other fellow's way as they followed the directions of a man on one side of the engine wearing street clothes and a white collar. He evidently was not the general foreman as there was no evidence of roundhouse soot and grease on his clothes. When you noted the efforts of the men to hide their grins as, at each fresh move, the engine got another pair of wheels off the track, you were sure that he was someone in authority.

Suddenly, from the off side of the engine a new actor appeared in the scene.

"Here! What's going on. About two dozen of you fellows get back on your jobs in the house. Tony, you and Casey Jones, stay and take that frog up."

It was a deep voice, pleasant in tone, yet commanding, from the other side of the engine, and the two men in overalls did as directed without question. They recognized the voice of Big Tom Carleton, the general foreman who had captained them in many a winter's fray.

The man in the white collar was evidently taken by surprise. He looked up and his face bore a mixture of chagrin and anger that was not a pleasant thing to see. Tom, who had been home to dinner, had come back by way of the coal wharf and the outbound tracks, and therefore approached on the opposite side of the engine.

When Tom came around to see how things looked on the other side he stopped short as his eyes fell on the man in the white collar. He looked for a moment in mute astonishment. To say that the situation was embarrassing is putting it mildly. Being a man of rare native tact, Tom realized that the best he could do was to say nothing, which he did.

The man in the white collar was his superior, the recently appointed young master mechanic.

It was nearly time for several passenger engines to leave the house and with the turntable blocked, things began to look serious. Without further ceremony, Big Tom had the two men on the ground replace the blocking and the frogs after his own style, and when this was done in a matter of five minutes, he told the hostler to "give her steam." The engine went back on the track as though it were a good beast who recognized its master's voice.

When the job was done, Tom looked around, but the master mechanic had disappeared. This proved to be the first open breach between Tom Carleton and the young man who had come on the job the previous spring when the old war horse, Tom Carleton's idol, had been gathered

to the land of his fathers. Just why Tom had not succeeded to the master mechanicship was a much discussed question. Tom seemed the logical man for the job, and the appointment was a surprise to every one. There were whispers about a friend of somebody else's friend "higher up," but that's another story.

The new master mechanic had arrived just after his predecessor had died in the late spring. He had kept his hands off the Greenfield roundhouse until the early fall.

The first indication of friction had come over overhauling the ash hoists. The ashes from the ash pit were loaded in cars by a locomotive crane, and one morning while Tom and the master mechanic were making the rounds Tom remarked that he was arranging to send this crane to the back shop for general overhauling. Immediately the master mechanic began to ask questions about its condition and finally suggested they take a look at it. As they climbed up the little iron ladder and stepped in the narrow doorway to the engine compartment, they all but upset the engineer, a careful fellow and extremely neat. He was up on the coal bin shining up the brass pop valve. Everything was in ship-shape, and the master mechanic could not see the necessity of giving it a general overhauling just at that time.

On returning to the office that morning, the M. M. had spoken rather sharply about the folly of taking anyone's word for a job as large as overhauling a crane, and took advantage of the occasion of forcibly calling to Tom's attention the fact that if he gave more attention to personal inspection of some other jobs about the place it would materially help to reduce running expenses. Tom thought for a minute and said:

"Well, during one winter, the first that I spent on the job, we 'got in Dutch' by neglecting the crane in the fall and ever since then we have been giving it a yearly overhauling and have not had one failure."

"But why repair it now when it is in good shape," said the master mechanic. "It's running all right and I don't see why you can't get through the winter with it."

"The very reason I want to take that crane to the shops to inspect the parts we are unable to see from the outside. You can see what's on the outside every day, but what's on the inside you can't see unless you take it apart. Did you notice how neat the whole crane looked? The engineer is just as interested in getting that machine through the winter without a breakdown as I am and if there was anything wrong that you could see, he would have told me about it long ago. We can spare the crane a week now without any serious delay, but in the winter time when labor is hardest to get, lose that crane for an hour and we are up against it."

Big Tom's arguments were of no avail, and the crane remained in service without its regular annual overhauling, and the results were just as predicted. During the very first heavy snow storm, the main center pinion gave out, which necessitated putting on an extra gang of shovelers whose wages amounted to many times the cost of a general overhauling of the crane. To make matters worse, the master mechanic made an investigation and suspended the engineer for 30 days, claiming that the wearing out of the pinion was due to a lack of necessary attention from

the engineer. Tom felt very badly about the entire affair, but refrained from mentioning it. The master mechanic thought all the time Tom was simply laughing at him, for he felt a little guilty. However, he had made a stand and would back it up, no matter what the cost.

The next thing that happened to broaden the gulf between the two men was some work done on the superheater units of the 4984 one day, when they were short of power. It seems that this engine had a leaky unit and Tom had taken them all out for they had been in some time. He had been criticised very severely for going to all this trouble when they were so hard up for power, but Tom claimed that it was fortunate they had done so for they had found several more that looked suspicious. While going through the roundhouse in the morning, the master mechanic noticed only two men working on the re-application of the units and had suggested putting more men on the job, but Tom told him they were all the men who could work in the front end to any advantage.

"Alright," was the reply, "have your own way about it, but remember we must have that engine for her regular run tonight at seven o'clock."

In the afternoon, the master mechanic again walked through the house and saw the same two men working on the job, so he felt that there was no prospect of getting the engine out. The very next morning as the two made their regular round of the house, the master mechanic looked for the 4984, but she was gone, so he asked:

"What time did the 4984 leave the house?"

"I don't know the exact time, but it was around 6:30—she was called for seven o'clock."

"You mean this morning?" asked the M. M.

"No sir, last night."

The effect of this answer was a great surprise, for the M. M. immediately went "up in the air" and as much as called Tom a liar.

"You cannot tell me anything like that, for I saw only two men working on the engine in the afternoon and they couldn't finish all that work in time to get the engine out before midnight."

The slur in the M. M.'s remark was unmistakable. Tom wheeled so that he looked him straight in the eye as he said: "Come into the office. The clerk is going to give you the time from the despatcher."

That was yesterday. And now, today, the affair of the engine off the track had been witnessed by enough of the force to make it common property. Conditions had grown serious and no one knew it better than Tom.

Knowing that the master mechanic, because of his nasty way of acting and talking, was totally unfit to be a leader didn't help matters in the least. He was still the master mechanic and Tom realized that something was bound to break before long. One of the hardest things to bear was his continual reference to the way things were done down at Muncie, a terminal of the N. & O. Railroad.

At this time Greenfield was visited by a heavy snow storm, and things were about tied up. For one thing, they were very short of passenger engines and had nothing in sight to help out. During the previous fall, Tom had ordered steam heat and signal equipment on a few of their freight engines then going through the back shop for general repairs. The M. M. had immediately stopped the work when he heard of it. He claimed it was entirely a waste of money for their passenger power was in good condition to go through the winter, but, again as predicted by Tom, they had reached the point where it was absolutely necessary now to equip a few good freight engines with signal and steam heat lines to help out on the heavy passenger trains. As this work had to be handled by the regular roundhouse force in addition to its other regular

work, it caused a serious condition that really resulted in a "tie up." Again Tom came in for the blame, for the master mechanic claimed he was negligent in not keeping his passenger power in first-class condition for winter service.

Yet the M. M. was the very man who refused to permit general overhauling of several engines, claiming they had not made nearly as much mileage as engines on the N. & O., where the roundhouse service was so good that engines were kept in road service for at least 18 months.

In order to equip the freight engines for passenger service, it was necessary to work day and night on them, so Tom remained on duty two days and all one night and the next night till nearly two o'clock. When he went home, he was completely worn out, having put in so many long hours lately, he did not get around to the roundhouse till about nine o'clock the next morning. The first man he met was the master mechanic, who immediately inquired where he had been. Tom told him of the long hours he had just put in so as to get engines to cover the passenger trains, expecting that he would receive some commendation for pulling them out of such a tight place, but imagine his surprise when the master mechanic seemed very much displeased and said that the foremen on the N. & O. always got to work on time, no matter how many hours overtime they worked. Tom was so disgusted at continually hearing about the N. & O. that, being nearly worn out trying to keep the place open, he made up his mind then and there that he would lay off and visit this wonderful place.

During the day he thought over many plans of how to make his visit but concluded if he went over as a visiting foreman, he would only get the good things, so the best way would be to go over and hire out as a regular workman; then he would be in a position to see from the inside how everything was handled. Before going home that night, he asked the master mechanic for a leave of absence of two months which was quickly granted, for the master mechanic was under the impression that Tom was working against him and that by having him out of the way, he could try out some of his own pet theories.

On arrival at Muncie, Big Tom had no trouble in securing a job as a machinist, and what a surprise for him was his first day at the new work! Where he had been accustomed to treating workmen as human beings, he found here that each man was simply recognized as a "unit" to get some one job done. Where he had his old roundhouse divided up by gangs, so that each man knew his place and had necessary tools or other equipment to handle his work in a quick and efficient manner, he found that at Muncie every job was handled in a "hurry-up-boys" manner without any regard as to whether it would hold up long enough to get over the division or not.

His first job was on an engine, the valves of which were reported blowing. He removed the steam chest covers and saw that the valve seat was so badly worn it really ought to be faced with the portable machine and then spotted down with a file, but on calling his foreman's attention to the condition, he was given a jolt by being told "never mind a thing like that, just scratch it over a little with your file so that I can swear we faced the seat if the engineer kicks."

Tom did not know what to do. He would have fired any man at Greenfield who did not go ahead and make a perfect job on a valve seat as bad as this one. In the first place, he would not permit any of his engines to get that bad before giving them proper attention, and his better judgment as a mechanic tempted him to go ahead and do a good job but he remembered now that he was simply a workman, subject to orders and had no right to do as he

thought best. So he scratched it a little on the highest point and let it go. Before he had the covers back in good condition, the foreman came up to him on the run and told him to "get the work out," for he had another hurry up job for him.

Tom's next job was on a badly cut truck journal which, he thought, should be removed, but his foreman told him to put in a new brass and plenty of white lead and the bearing would soon "come down." In olden times, he had used white lead on journals but had found from bitter experience that it did not pay, so he had not followed that practice for some years. Here at Muncie, they thought it was a late discovery in quick repairs.

Tom had decided to keep a little note book on new ideas he could pick up during his month's experience at Muncie. At the end of the first week, he had many notes entered but none whereby he could better the operation at Greenfield.

One thing he found it difficult to explain, and that was how they could keep their engine failures down to such a small number when the work in the roundhouse was handled in such a slipshod manner. One day while he was in the roundhouse foreman's office waiting to show his boss a job, he overheard a telephone conversation between the despatcher and the foreman. The despatcher evidently was telling the foreman how an engine on a passenger train was losing time, and the foreman answered by asking the despatcher to charge the delay up against loading express or passengers like they did the other day. This gave Tom a hint of how things were handled, so when he showed his job to the boss, he asked in an off-handed manner if they had many failures, for he noticed that not many were chalked up on the board against them. "Hell yes," replied the foreman, "failures are a common occurrence on our division, but our despatcher is the right kind of a fellow and helps us out a lot." He had been given to understand that failures were an unknown quantity at Muncie, but now he realized that failures were so common, they didn't even attract attention.

At Greenfield, the engines were maintained entirely by the roundhouse force from one general shopping to the next, but at Muncie he found it was the practice to send an engine to the back shop for extra heavy roundhouse repairs. Not only that, but the roundhouse force would watch repairs in the back shop and when a complete set of rods was ready for some back shop engine, they would remove a bad set from a similar class in the roundhouse and take the overhauled rods from the back shop so that their engine received a good set with only the trouble of removing one set and applying another. The roundhouse at Muncie was full of workmen who appeared to be on the run all the time, but yet they did not handle enough actual work to maintain their switch engines. They had no system and were always in a hurry, but did not get results.

Tom had been in a supervising capacity so long that it was second nature for him to take hold of things and get results, and it wasn't very long before it was noticed how he seemed to take hold of matters better than the ordinary workman and in about three weeks after he started to work, he was selected to act as an assistant foreman. At first, Tom refused for he wanted to get all the actual experience he could during his turn of employment, but on the other hand he figured what a chance it would be for him to get in "the harness" at the point he had heard so much about and be able to straighten out some of the bad practices that he knew existed there. A couple of weeks after he took hold of the work, even the master mechanic at that point noticed the change and had him in the office, to question him about his experience.

Now Tom was loaded with questions of his own that

he wanted answered and turned his visit into an examination of the master mechanic instead of being examined himself. He found that the master mechanic was not experienced in the practical side of running a big engine terminal and that he was being misled by the forces under his charge. They were taking advantage of his inexperience by "putting over" some raw deals which would some day get him into trouble. Tom could see how his good intentions to his own master mechanic at Greenfield had been lost, as that gentleman had been under the impression that everybody was trying to slip "something over on him" and would not believe that anyone was honest. Where he had been in earnest to keep business going at Greenfield, he could see how the foremen at Muncie were simply putting in ten hours each day without taking any interest in their work and thought they were successful when they could put the blame up to the other fellow. He loved his work, but at Muncie the foremen simply loved their pay.

Only about two weeks of Tom's leave of absence remained. The time had simply flown away. With the cold weather and heavy business, everyone had been driving himself to the limit. Many men were off sick with colds and the grip and the general foreman himself had said repeatedly in the last day or so that he was all in. With but a little over a week left before Tom's leave would expire, a very strange thing happened. The general foreman was taken with a serious illness, and the master mechanic sent for Tom and told him that under the condition he was going to ask him to become acting general foreman as they were in very bad shape for men. Tom started to object, but the master mechanic would not listen to him, and the result of it was that he took the job.

About this time he was enlightened as to the past training of his master mechanic at Greenfield. He had made several guarded inquiries and had been unable to learn anything about his employment at Muncie till one day he spoke to one of the old mechanics, who immediately placed him as "that kid gloved college boy with the big brown headlights." He also went on to say that this college boy had been so awkward that they had kept him in the office on report work, to keep him from harm. Tom had to smile to himself at the recommendation, for he had been given to understand that one of the most important pieces of furniture at Muncie had been this same gentleman.

As the end of Tom's leave of absence approached, he really felt sorry to leave Muncie for every one was good to him and as the general foreman had not yet recovered from his sickness, he had the opportunity of "throwing his feet" and showing the people at that point what it was to really manage a large terminal, and the result was that business was in the best shape it had been for years.

The day Tom was going to resign to return home, the master mechanic sent for him and told him the present general foreman was going to be incapacitated for a long time, and offered him the position of general foreman at Muncie.

"We had intended," said the master mechanic, "to secure a man off the Y. & A. Z. for this position, but he seems to have disappeared, and as you are evidently well able to handle our terminal, we are glad to offer you the position."

"May I inquire who was the man on the Y. & A. Z. that you were after?"

"Thomas Carleton was his name," replied the master mechanic, "and we are very sorry that we cannot secure him, for he is one of the best roundhouse managers in this part of the country," he continued.

"Let me tell you a little story," said Tom, "before I take this job, and then if you want me I will be glad to accept your offer. To begin with, I have had several years' experience in the roundhouse and have always found that a true spirit of hon-

esty pays big dividends. I have studied the practical side of roundhouse management from "A" to "Z" and know there are many things about a roundhouse that cannot be learned from books but require long and careful study. In my last position my superior officer was always quoting the efficiency and economy of your roundhouse, so I came here to learn how to play the game both ways, and have concluded that it can't be done. There are a number of practices that exist in your shop of which I do not approve. My experience here has convinced me that I am right and that these things are wrong. Calling a spade a spade never hurts the man whose intentions are in the right direction. Paper records not based on fact will finally lead to trouble."

"Now in a way I have imposed on you, but if, after hearing me and thinking it over, you still care to give me the

LADDER RIVETING MACHINE

BY J. H. CHANCY

Foreman Blacksmith, Georgia Railroad, Augusta, Ga.

A machine for making freight car ladders has been developed by C. M. F. Bernhardt, car department foreman of the Georgia Railroad, which has proven entirely satisfactory and with which iron ladders can be made at a cost some 35 per cent less than the price paid for these ladders in the open market.

As shown in the illustration, the machine is made from bar stock, and is operated by air, a 12-in. by 14-in. brake cylinder being used to drive it. The ladder made on this machine consists of 13 1/4-in. by 13 1/4-in. by 3/16-in. angles for side pieces and 5/8-in. rods for the rungs, the angles being spaced 18 in. apart. The rods used are taken from scrap.

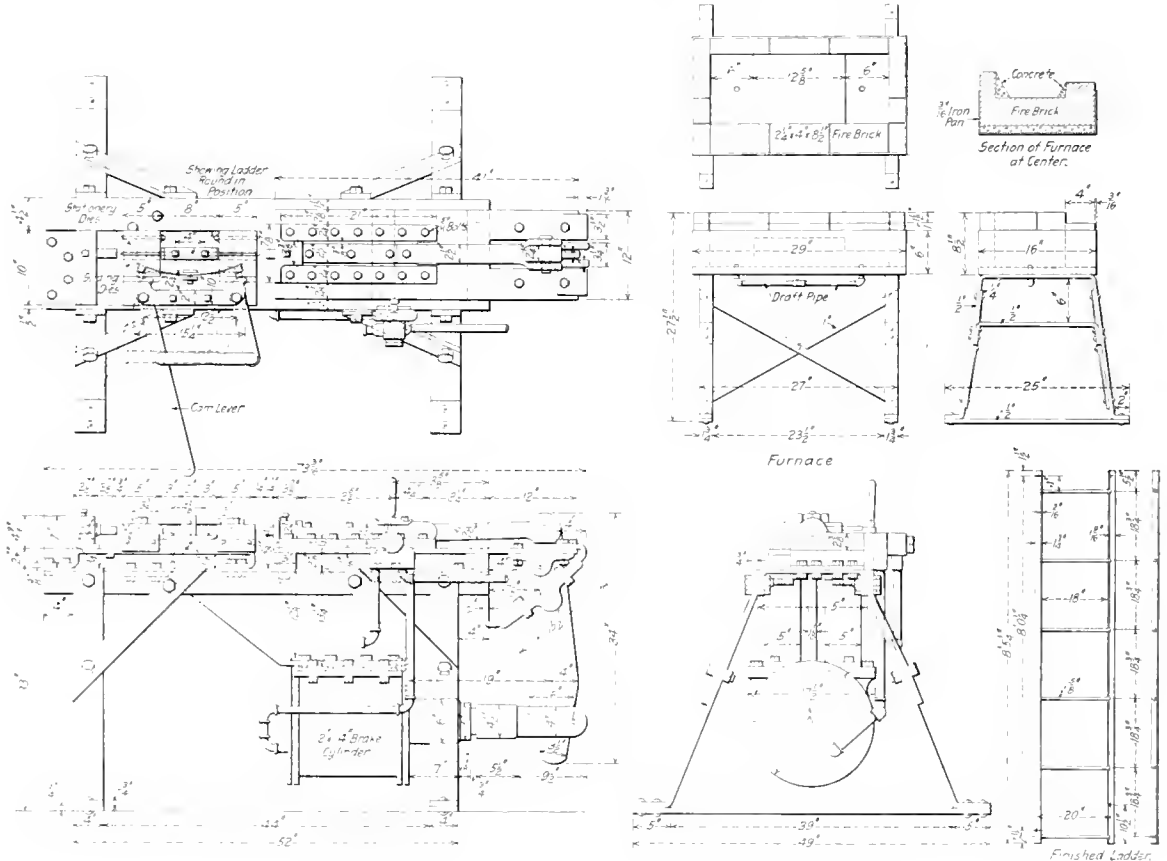

Machine for Building Ladders with Angle Sides and Round Bar Rungs

job, I will be glad to try it out. My right name is Tom Carleton, and I am from the Y. & A. Z. at Greenfield." Tom paused as he rose from the chair in which he had been sitting and made several steps to the door. Turning and looking square at the master mechanic he said: "I am now going to my boarding house and unless I hear further from you will take the midnight train for Greenfield." With that he hastily opened the door and passed out.

The following morning a new notice was found on the board at the Muncie roundhouse:

"NOTICE,

"Effective today, Mr. Thomas Carleton is appointed general foreman at Muncie, in charge of the entire locomotive terminal."

The machine will rivet the rungs to both side piece angles in one operation.

The top view of the machine shows a rung in the clamps ready for riveting, the angle side pieces not being shown. These clamps slide on suitable ways so that the movable rivet die at the right will force the rod into the die at the left, thus riveting it to the side piece. The clamps are operated through a system of lever cams, and are maintained in the open position by a leaf spring. The right hand plunger slides on suitable ways on the bed of the machine, and is operated by the brake cylinder pistons through a system of levers. A three-way valve is used to operate the mechanism. A special type of furnace has been developed for heating rods at each end. This is also shown in the illustration.

New Devices

HEAVY DUTY CAR WHEEL GRINDER

A heavy duty car wheel grinder is shown in the photograph, which has a capacity of from 28-in. to 42-in. wheels and an actual swing of 44 in. on the centers. Axles up to 8 ft. in length can be accommodated.

It will be noted that this machine, which is built by the Putnam Machine Company, Fitchburg, Mass., is entirely self-contained and is driven by a direct connected motor. This machine has been designed along generous lines with a special view of combining maximum production with minimum exertion of the operator. The bed is heavy and is cross tied and braced so that it will absorb vibration due to the heavy duty imposed. The headstock is bolted solidly to the bed. The tailstock is gibbed over the outside surfaces and is provided with power movement longitudinally, the control being so located that the operator can reach it without moving from his post in front of the machine. There is also a patented clamping device that automatically clamps the tail-

justed automatically for the several standard wheel contours while the machine is running. Provision is made for furnishing cooling compound to the working faces of the grinding wheels by a motor-driven pump and necessary piping. Special pans and channels are provided to return the compound to the reservoir.

The net weight of the machine is 45,000 lb. and the equipment includes a self-contained calipering attachment for sizing wheels, as well as other accessories.

FILE CLEANING AND SHARPENING MACHINE

A portable file cleaning and sharpening machine is shown in the photograph. It is a complete unit in itself and can be adapted to use either compressed air or steam at pressures from 80 to 150 lb. The higher pressure will, of course, cut much better than the lower pressure.

A special flint abrasive is used which can be secured at

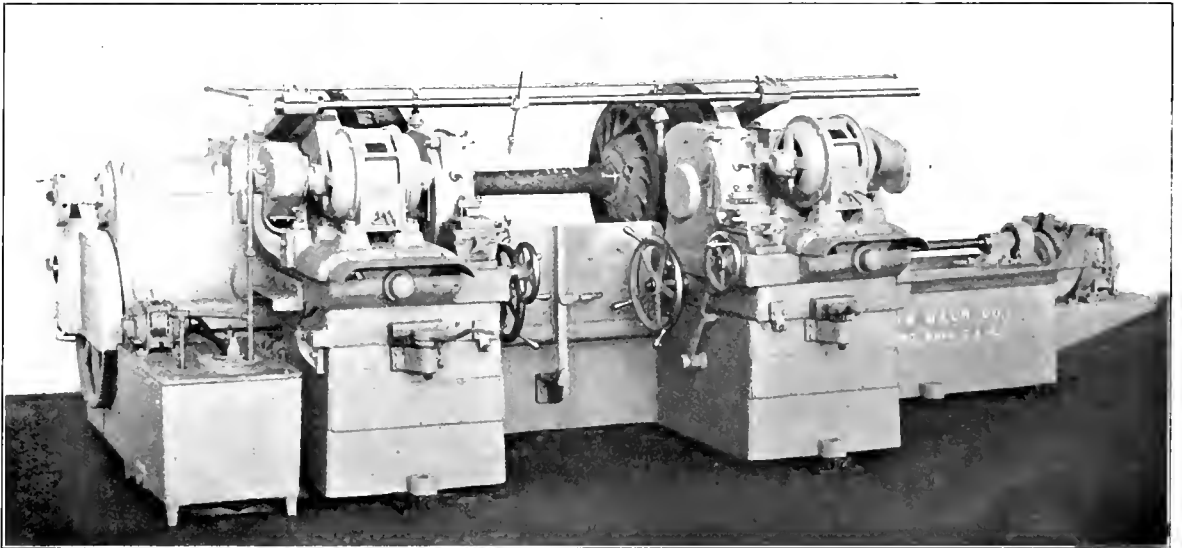

Front of the Wheel Lathe Showing Control Levers

stock when it reaches the desired operating position. The face plates are equipped with Putnam patented non-slip driving dogs which require no adjustments other than to release by hand when the wheels are in position, the engagement being entirely automatic. The main spindles are provided with adjustable sleeves, so that in chucking wheels, variations in the length over all of axles are automatically compensated and the distance between the dogs on the face plate remains constant.

The grinding wheels are mounted on high carbon steel spindles, running in tapered bronze self-oiling bearings. The thrust of the spindles is taken up by ball bearings. The base castings for grinding wheel slides are cast integral with the main bed of the machine in order to add to their rigidity and preserves the alinement. The grinding wheels may be ad-

justed automatically for the several standard wheel contours while the machine is running. Provision is made for furnishing cooling compound to the working faces of the grinding wheels by a motor-driven pump and necessary piping. Special pans and channels are provided to return the compound to the reservoir.

The net weight of the machine is 45,000 lb. and the equipment includes a self-contained calipering attachment for sizing wheels, as well as other accessories.

A portable file cleaning and sharpening machine is shown in the photograph. It is a complete unit in itself and can be adapted to use either compressed air or steam at pressures from 80 to 150 lb. The higher pressure will, of course, cut much better than the lower pressure.

A special flint abrasive is used which can be secured at

bottom of the drum. It is then ready to be syphoned up by the jet and used over again. This machine is built by the Macleod Company, Cincinnati, Ohio. It is claimed by the manufacturers that any shop using as low as 10 dozen new files each year can install one of these devices and pay 20 per cent on the investment each year. A plant using 50



Files Being Cleaned in a Buckeye Machine

dozen would pay 100 per cent on the investment, for cleaning files alone; and another feature of the outfit is that it can be used as a sand blast for small castings. There is a hand-hole in the top of the upper hopper through which the castings to be sand blasted may be introduced.

A COLLAPSING TAP

In the photograph is shown an automatic collapsing tap designed by the National Acme Manufacturing Company, Cleveland, Ohio. It will be noted that the greatest diameter of the tap is that across the chasers. There is, therefore, no

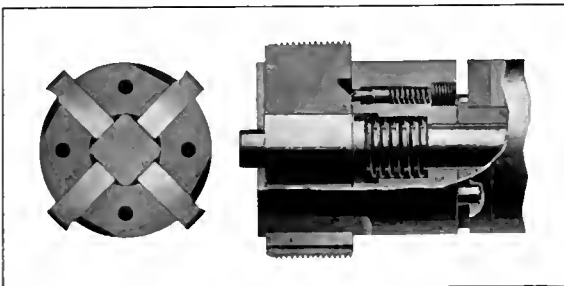

Internal Details of the Collapsible Tap

limit to the depth to which the tool may be advanced, it only being necessary to increase the length of the shank. As will be seen in the photograph, the backs of the chasers are supported for their full length against a center pin of rect-

angular section. When the travel of the turret is stopped at a specific point, the tap continues to cut, advancing several threads until the pins at the bottom of the chaser holder are disengaged from the holes in the end of the stationary portion of the tool. The chasers are then free to revolve with the work. As the backs of the chasers are brought opposite the flat surfaces of the center pin they collapse, due to the wedging action of the spring actuated pins against sloping sides of the recesses in their under sides.

To remove the chasers for grinding, it is only necessary to loosen the top plate and the chasers will drop out. There are no openings where chips or dirt may get into the interior of the tool. All parts are interchangeable and the chasers have been tested to cut a commercially perfect thread before being placed in the tool. A graduated index provides adjustment for under-size and over-size threads when tapping for tight or loose fits.

POWER FAST TRAVERSE FOR MILLING MACHINE TABLES

A recent improvement in large milling machines is the power fast traverse for the table that is now made an integral part of every heavy service milling machine built by the Brown & Sharpe Manufacturing Company.

This power traverse will not only return the table quickly, but will advance it rapidly until the work is in position for the cutters, or will cause the table to speed up where there are spaces intervening between the surfaces to be milled. The physical exertion required to return the heavy table by hand after each cut is eliminated, the operation being performed by moving a lever conveniently located.

While this power fast traverse is an integral part of the machine it operates entirely independently of the regular

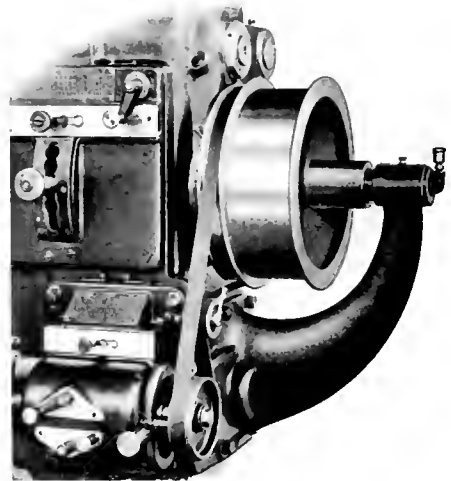

Method of Driving the Power Fast Traverse

feed change mechanism. When it is used during the time that the regular feed is engaged, the regular feed is automatically thrown out, but as soon as the power fast traverse is disengaged, the regular feed is automatically thrown into action again.

The mechanism is contained in the feed box of the machine and is driven from the machine driving pulley by a narrow belt. The diagram shows the arrangement of the mechanism. The sliding sleeve A is keyed to the shaft B, that delivers the power from the feed case to the telescopic shaft leading to the feed mechanism in the knee and saddle. On one end

of sleeve A is a toothed clutch and on the other a friction clutch. When the toothed clutch is engaged, the drive is through the regular feed changing mechanism, and when the controlling lever is thrown over to operate the fast traverse, the sleeve A disengages from the regular feeding mechanism and the friction clutch at its opposite end is thrown into the

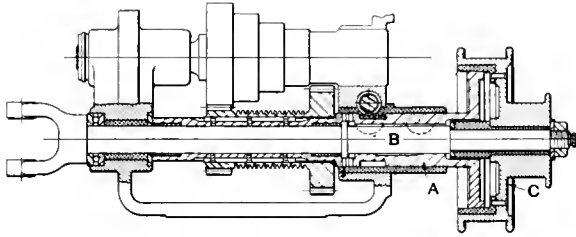

Mechanism of Power Fast Traverse

fast traverse driving pulley C. The drive is now direct from this pulley to the feeding mechanism in the knee and saddle, and since the fast traverse driving pulley is belted directly to the main driving pulley of the machine, the movement of the table is greatly accelerated.

The friction clutch and narrow driving belt are intended

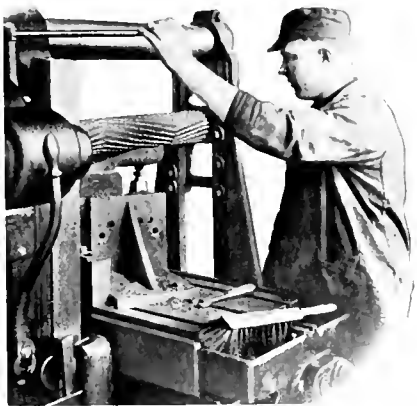

Operator Throwing Power Fast Traverse into Action

to prevent damage to the machine or cutters in case of the work running into the cutters when moving the table up at the beginning of a cut. It is not intended, however, that the operator should depend on this to prevent damage, for while not probable in most cases, it is possible sometimes to break small or delicately made cutters in this way.

REVERSIBLE ECCENTRIC AND SIDE RODS

The necessity for carrying side rods and eccentric rods in stock in pairs, right and left, ties up a considerably larger amount of material than if one rod could be made to answer both purposes. Of course, if a rod should be required for the left side and only rods for the right side were in stock it would be possible to cut the rods, turn one end 180 deg. in relation to the other and weld together. Valuable time might be lost in doing this, however, and there would always be the possibility of a poor weld, especially if the operation was performed at an outlying point.

One thing only stands in the way of using the rods indiscriminately and that is the oil cup. Three employees of the locomotive repair machine shop of the Delaware, Lackawanna & Western at Scranton, Pa., all of whom have had extensive experience in rod work, realizing this have designed

and patented, and have in actual use, rods which have oil cups forged on both sides of the rod as indicated in the drawing. This adds only a small amount to the weight of the rods and requires some additional machine work. The slight added expense is offset many times by the advantage of a reduction of 50 per cent in the amount of stock which must be carried and in added convenience.

These advantages are made almost immediately available

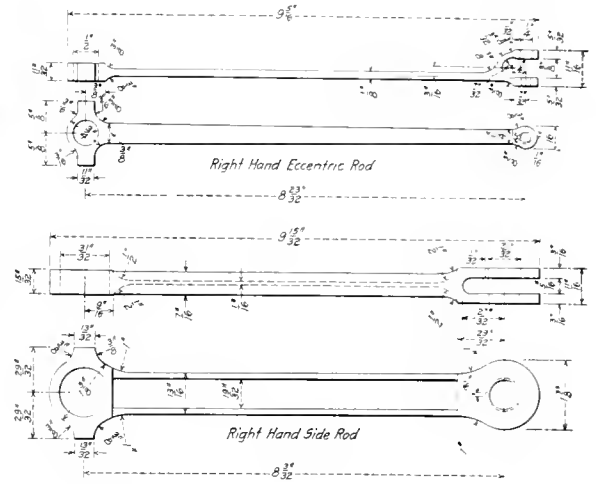

Eccentric Rod and Side Rod Which Are Reversible

if the reversible rods are placed in stock as the present stock diminishes. The patentees are Charles E. Weitaw, William R. Owens, and H. R. Jones, all of the above mentioned address.

UNION AUTOMATIC TRAIN PIPE CONNECTOR

Any automatic train-line connector that is to be used extensively should not only provide an automatic means of connecting up train, signal and steam lines, but should provide a means of easily restoring the present manually operated coupling, for use with cars not provided with automatic connectors.

A connector embodying this feature and known as the

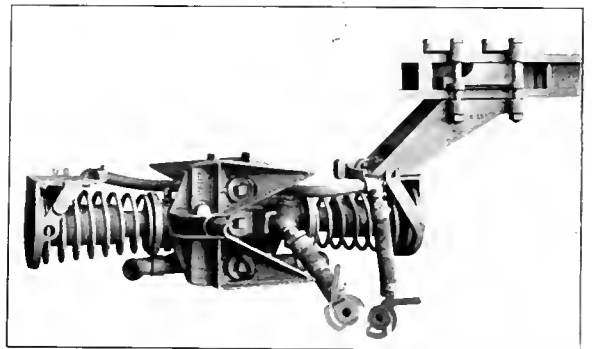

Fig. 1—Method of Attaching to Three-Stem Passenger Coupler Shank

Union connector, manufactured by the Union Automatic Connector Corporation, Jackson, Miss., is shown in Fig. 1. The connector is here shown attached to a three-stem coupler shank for passenger service. It will be seen that the connector is suspended independent of any other equipment, and

that the space occupied is that usually occupied by the ordinary manually operated couplings. As will be pointed out later, this method of attachment is to take care of the transition period while both automatic and non-automatic connectors are in use, and when that is passed, specially designed drawheads will be provided for taking care of the equipment, eliminating the present interchange features and the steam hose. As will be noted in Fig. 2, the Union connector is of the side-port type, that is, the gasket faces are in a vertical plane nearly parallel with the longitudinal center line of the car. In this photograph one of the cages, which can be seen

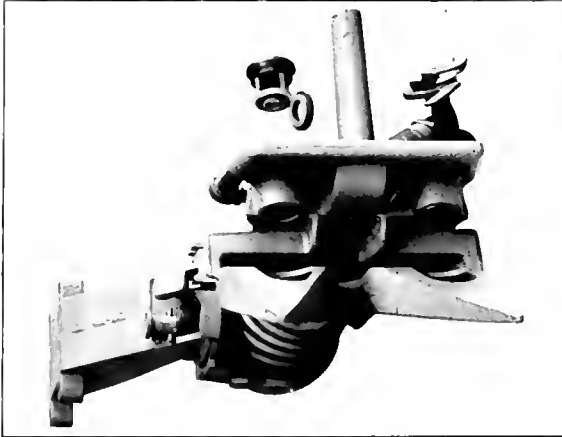

Fig. 2—Front View Showing Gasket and Cage Removed

from the side in Fig. 1, has been removed. The end of this cage is the rear support of the gasket, which can therefore be removed and replaced without breaking the connection between two cars, by merely unscrewing the cage as shown. In the case of the air and signal gaskets, the cage and gasket are designed so that the gasket has a snug fit in the bottom of the cage. This facilitates the application of new gaskets, as

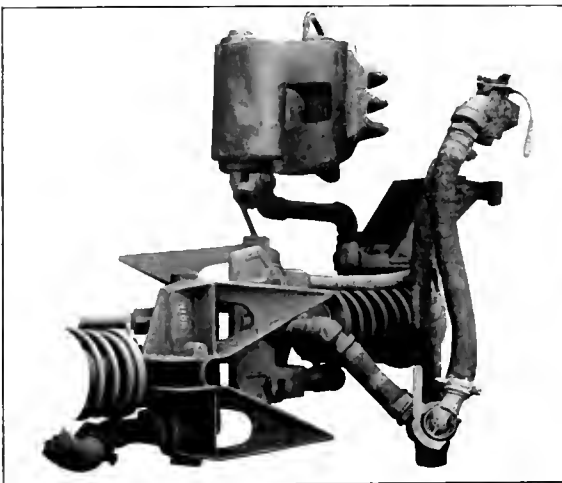

Fig. 3—Coupling with One Connector $4\frac{1}{2}$ in. Low and 3 in. Off Center

after the gasket is seated in the cage, the latter can be screwed into the coupler without the exercise of special care.

While the air and signal gaskets fit closely against each other, the steam gaskets do not touch, but are slightly loose in their seats before the steam is turned on. This allows the condensed steam to drain out when steam is first turned into

the line, thus obviating the use of troublesome drip valves. The steam gasket and follower are arranged to expand as the temperature is raised, thus securing a tight joint. Fig. 3 shows two passenger heads about to couple, one of them being $4\frac{1}{2}$ in. lower than the other, and horizontally off cen-

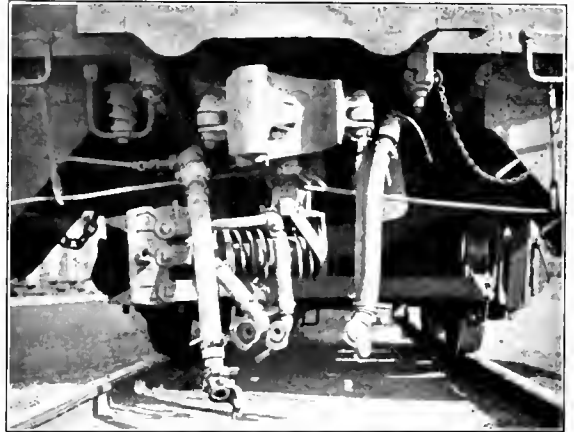

Fig. 4—Connector Turned and Locked in Non-operative Position

ter about 3 in. It will be noted from the shape and angle of the horns engaging the post and also the broad tongue opposite the pocket, that the two connectors are thrown into position when the cars are brought together. The connector has a 10-in. horizontal and 11-in. vertical gathering range. Free movement is obtained through the means of a pin and a telescoping mechanism around which will be noted a coil spring.

When the heads have been coupled by the interlocking of

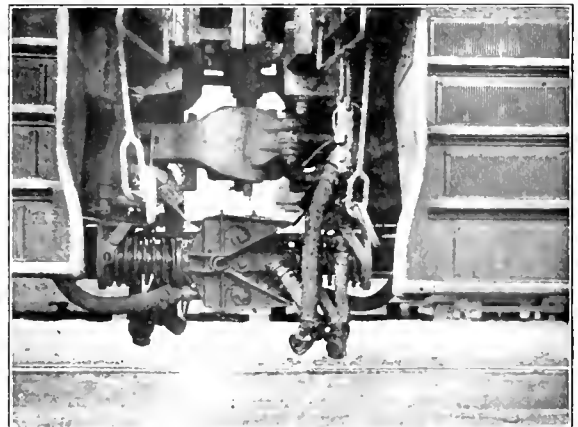

Fig. 5—Side View of Two Passenger Cars Coupled

drawheads, each spring has been compressed $2\frac{1}{2}$ in. to 3 in., producing a tension of about 150 lb. each. After being coupled, the design of the various engaging surfaces is such that the heads lock themselves and no locking mechanism is provided. No movement of the heads relative to each other is possible while they are coupled, a long gasket life being thus assured.

While the heads are rigid relative to each other, freedom of movement of the two heads acting as a unit is provided in the telescoping and pin mechanism above mentioned. The gaskets are not in a plane exactly parallel with a vertical plane through the center of the coupler yoke, and the connector engaging surfaces are so arranged that the gaskets on

either of the couplers never touch until the coupling is completed, this being the last part of the operation. There is therefore, no tendency to knock the gaskets out of place or ruin them by abrasion. The photograph shown in Fig. 4 illustrates the way in which the coupler heads may be swung out of place on a turntable. This turntable, at the bottom of the connection up to the coupler yoke, has two locking positions, one with the connector in operating position and the other in the out-of-service position. To entirely remove the equipment from a car, it is only necessary to throw out the turntable pin, lift the latch and unscrew the steam hose union.

Two passenger cars coupled with full equipment are shown in Fig. 5. The ordinary steam heat hose in this picture has been removed in order to allow a clear view of the coupling. In installing this equipment it is necessary to introduce a three-way cock back of the present steam heat cock at the end of the line. This is used in place of the old steam heat valve and is arranged so that it can be operated from the vestibule of the car.

FILTER AND GREASE EXTRACTOR

A filter and grease extractor is shown in the photograph, which consists of two chambers, each containing a single filtering element in the form of a spool on which a length of Terry linen is wrapped, with the layers separated by alternate layers of a wire mesh spacing mat. It is designed for the filtration of boiler feed water and made by the Lagonda Manufacturing Company. All of the water is filtered and refiltered through five layers of the filtering cloth, obtaining the removal of suspended solids, oil and grease. This ef-

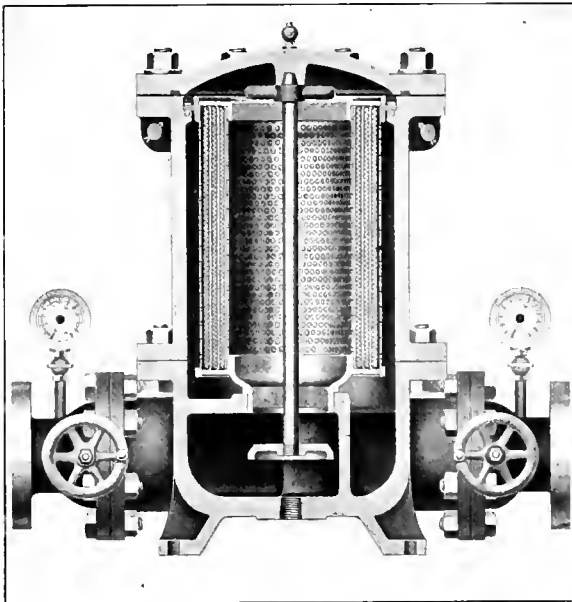

Sectional View of the Grease Extractor

fective filtration is secured with a minimum drop in pressure as the velocity of the water is greatly reduced when entering the large filter chambers.

Gate valves at the inlet and outlet control the chambers and the latter may be cut into or out of service by simply shifting these valves. The usual method of operation is to have one chamber in service at a time with the other one held in reserve. Then when it is necessary to clean one chamber, the valves are shifted and the reserve chamber is thrown into service and the other may be opened and cleaned. Thus there is always a continuous supply of clean water

furnished to the boilers and there is no by-pass necessary and none is provided. Advantage may be taken of the double capacity of the filter in time of overload or unusual condition requiring more water, when both chambers may be thrown into service.

Cleaning is accomplished by unrolling the fouled linen from the spool and replacing it with a clean extra length which is furnished. The dirty linen can be washed and used over repeatedly. The filter spool is lifted from the filter chamber by means of a handle at the top of a valve stem. As the spool is lifted out the valve closes the bottom so that all dirt which has accumulated within the core of the spool is lifted out with the spool itself. When the filter is in operation, this valve is held open by the cover which engages the valve stem.

An arrangement for flushing out the filter chambers without removing the cover is provided, pipe connections being located near the top of each chamber for a water supply. Blow-off connections are at the bottom of each chamber. All internal parts are of bronze and the complete machines are tested at a pressure 50 per cent in excess of that at which they are to operate.

PEDRICK HORIZONTAL BORING MACHINE

A novel type of horizontal boring machine, which has been developed by the Pedrick Tool & Machine Company, Philadelphia, Pa., retains several of the inherent features of the portable boring bar manufactured by the same company. Although of simple construction, the machine is adapted to use on a wide range of work.

This machine consists of a heavy substantial bed having a T-slot on each side of the upper surface. Two housings are fitted to the bed and are movable to suit conditions. On both sides of the housings are T-slots, by means of which

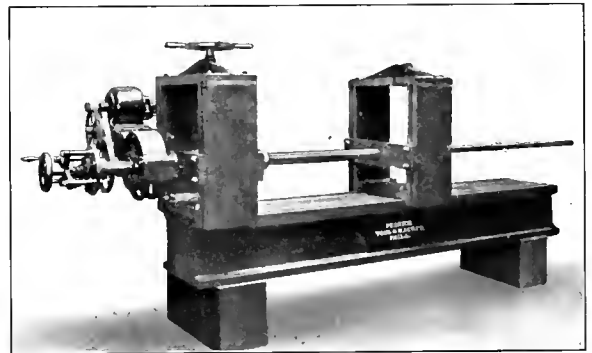

A Simple Horizontal Boring Machine

the bar supports are held in position at suitable heights above the bed. The main bearing for the boring bar is a long quill, with crossheads at both ends. These are bolted to the front housing on both sides and give unusually rigid support. The quill is bored to fit the bar and the cross members are faced from the bore, so that proper alinement of the bar is assured wherever it may be located on the housing. The handwheel shown in the illustration operates the elevating screw for raising or lowering the bar to the desired height. A ball thrust bearing makes this adjustment easy.

The boring bar is driven through variable gearing, so that the speed can be readily adjusted for boring holes of different diameters. The feed case, located on the end of the boring bar, provides constant automatic feed, with three speeds in either direction. The feed screw, in a recess on the boring bar, permits of longer continuous feed than the usual travel-

ing bar affords. Quick return of the bar is secured by removing the half feed nut and sliding the bar through the bearings.

For boring or drilling holes smaller than the main bar a taper hole in the end of the bar is provided, so that this machine with a 3-in. bar will bore any hole up to 16 in. in diameter. If the hole to be bored is large enough for the convenient operation of the main boring bar, the work is placed on the bed, the bar with the proper size cutterhead on it is pushed through the hole and through the rear bearing on the back housing. Thus the bar is rigidly supported at both ends and the cutterhead travels along the bar, boring the hole to the diameter wanted. If the hole to be bored is smaller than the main bar, auxiliary bars are used. In this case the main bar travels and feeds the smaller bar.

A table at right angles to the bed, with a cross slide, is provided and adds considerably to the convenience of handling various classes of work.

This boring machine is being built with bars of several diameters, depending on the work for which the tool is to be used.

RADIAL DRILL

In the photograph is shown a radial drill built by the Morris Machine Tool Company of Cincinnati, Ohio. It will be noted that this drill has a column of substantial proportions, which swivels on roller bearings in a stump securely bolted and doweled to the base, and projects deep enough in the stump to insure alignment under heavy strains. There is also provided an arrangement to take up wear in the column bearings.

The arm and arm bearing are of generous proportions and

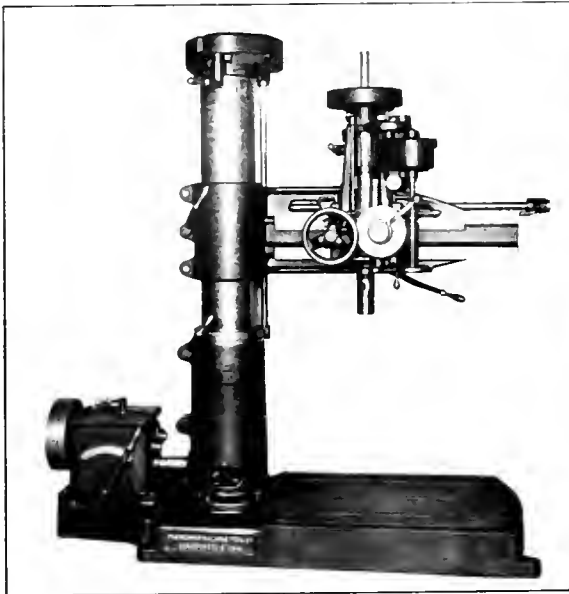

Drill for General Heavy Work.

are provided with an arrangement for taking up wear. The arm is clamped by one lever, convenient to the operator. It is raised and lowered by means of a screw operated by tumbler gears that are engaged by a handle within easy reach of the operator. These gears are so arranged that they have a tendency to disengage, thus forcing the operator to retain his hold on the handle while the arm is in motion. If, by any chance, the arm should reach the extreme position before the elevating handle is released, the gears would automatically

disengage themselves and the operator could not hold them in mesh. The head is traversed by means of a rack and pinion and the hand wheel on the left side of the arm.

All gears are of steel and are covered. The back gears are engaged or disengaged while running, by a lever at the left of the spindle. The spindle is a hammered forging of high carbon steel, the thrust of which is taken up by a ball bearing. Ten spindle speeds are secured on the cone drive and a 12 on the speed box drive. A direct reading depth gage and automatic feed trip is furnished. The clutches are heat treated and hardened, and the bearings are of phosphor bronze, arranged with oil chambers and felt wipers. The machine weighs about 3,500 lb. Either motor drive or belt drive can be furnished.

AUTOMATIC FREIGHT CAR DOOR LOCK

The accompanying illustrations show the Ideal automatic freight car door lock made by the Gustin-Bacon Manufacturing Company, Kansas City, Mo. One view shows the door shut and locked, and the other shows the door just about to be closed and the action of the lock just before the hasp drops into place. It will be seen that as the beveled end

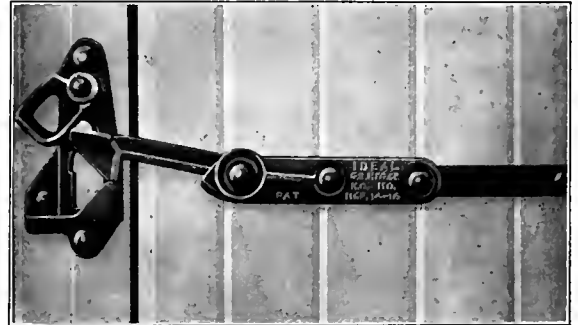

Automatic Freight Car Door Lock with Door About to Close

of the hasp strikes the catch casting it slides up and drops into place, allowing the locking casting to fall into place. When the door is pushed shut the lock automatically runs into position for sealing, and eliminates the necessity of using a bolt or pin seal. This automatic feature is of special interest as a good many times difficulty is experienced in holding the door closed on some of the cars while the seal

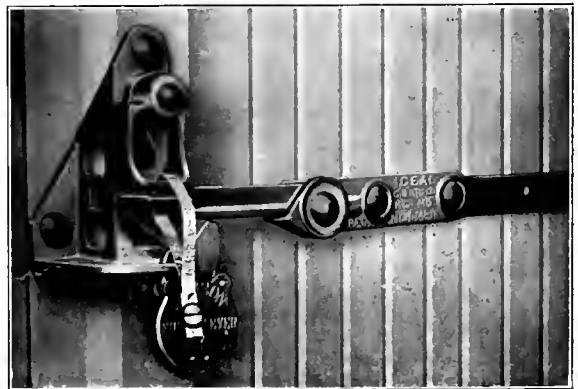

The Lock Closed with Seal and Padlock In Position

pin is being put in place. This lock automatically fastens the door the first time it runs shut. It is made for wood or steel cars, and consists of two assembled malleable castings

which are easily applied. The illustrations also show that a padlock may be used in addition to the door seal.

HEAVY DUTY ENGINE LATHE

In the illustration is shown an engine lathe built for extra heavy duty and with the idea of making it powerful enough to completely utilize the capabilities of high speed tool steel. It is built by the Oliver Machinery Company, Grand Rapids, Mich.

The headstock is long and heavily ribbed and has a long bearing on the lathe bed. The front spindle bearing is 6½ in. by 10 in. and the rear 4½ in. by 7 in. There is a range of 12 spindle speeds from 8 to 300 r.p.m. All gears are cast steel of large pitch diameter and wide face and run in oil. The pinions are steel forgings. The spindle is a high carbon steel forging, accurately ground and the spindle nose is of such design as to permit easy threading or removing of the face plates. The speed control levers are large and are so arranged that they can easily be reached. The spindle speeds are selective.

The tailstock is moved by means of a geared crank and it is made long in order to secure a good grip to the bed when it is clamped in place by four hardened nuts. The bed is of substantial design, the span being 23¾ in. over all and is braced by box sections. The length of the carriage is 40 in. and the span of the bridge is 12 in. over all. The carriage has a regular feed hand wheel, which is used when the carriage is in position to take a cut and also a rapid motion crank used for making rapid changes.

The apron has a removable front plate, permitting easy access to the entire internal mechanism. Both longitudinal

motor drive and either direct or alternating current. Seven and one-half to 15 hp. motors are recommended with a limit of speed of 600 to 900 r.p.m.

THE DETAILS OF AN ARCH TUBE CLEANER

In the illustration are shown the details of a Lagonda Arch Tube Cleaner. This tool is of particular interest because of the principles involved in its internal construction. It will be noted that power in the form of compressed air or steam is introduced into one end of the tool through suitable holes and couplings. Two ports are provided, 180 deg.

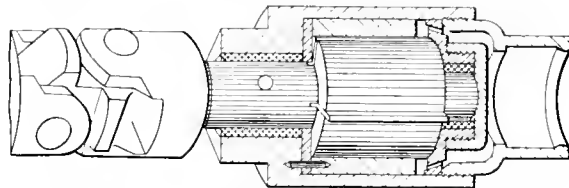

Drawing Showing the Inside of the Arch Tube Cleaner

apart for introducing the power into the rotor. The rotor is provided with four steel blades, placed 90 deg. apart and working in slots in the rotor. These blades are forced out against the inside casing of the tool which is elliptical in cross section, so that when the rotor revolves, the blades are moved in and out of their slots. This provides a means of getting pressure against one side of the blades and driving the rotor forward, the steam or air being released to the

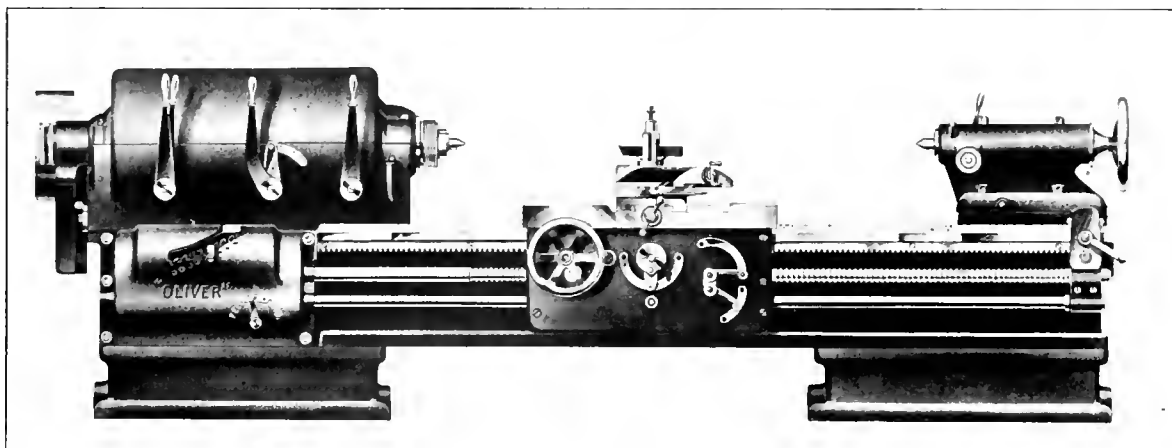

Front of Engine Lathe Showing Control Levers

and cross feeds are friction drive and can be thrown into action by means of the same lever. Both feeds cannot be thrown in at the same time and the feed mechanism cannot be thrown in when the lead screw is in operation. The crank for moving the carriage by hand is geared by means of compound gears to the rack pinion, so that the heavy carriage and apron can be operated as easily as that of an ordinary 16-in. lathe. All gears are of forgings or steel castings. All bearings are bushed with bronze.

The feeds and threads are controlled by the quick change gear box. There are 33 feeds ranging from .013 in. to .333 in. per revolution of spindle, and 33 threads, ranging from one to 16 per in., are obtained by simply changing the lever positions as indicated on the table on the gear box. The gears are steel and the bearings bronze. Changes may be made while the machine is running.

The headstock is designed for individual constant speed

atmosphere through two exhaust ports, placed at angles of 90 deg. from the supply ports. The blades are always under pressure so that there is slight possibility of the cleaner becoming stalled in the tube, if properly operated.

These cleaners, made by the Lagonda Manufacturing Company, Springfield, Ohio, are said to have an air consumption of 45 cu. ft. of free air per minute at 60 lb. pressure. For best work they should be operated with air or steam at 60 or 80 lb. pressure. The cutting tools are attached to the rotor by means of a universal toggle joint, so that the machine will pass easily around the bends of the tubes.

EFFECT OF SOOT IN BOILERS.—A scoop of slack coal will convert 120 lb. of water into steam in any well-kept boiler. If the flues and flue sheets are covered with ¼ in. of soot it will only evaporate 66 lb. of water.—*Railway and Locomotive Engineering.*

Railway Mechanical Engineer

(Formerly the RAILWAY AGE GAZETTE, MECHANICAL EDITION
with which the AMERICAN ENGINEER was incorporated)

PUBLISHED ON THE FIRST THURSDAY OF EVERY MONTH BY THE
SIMMONS-BOARDMAN PUBLISHING COMPANY

EDWARD A. SIMMONS, *President* L. B. SHERMAN, *Vice-President*
HENRY LEE, *Vice-President and Treasurer* M. H. WIUM, *Secretary*
WOOLWORTH BUILDING, NEW YORK, N. Y.
F. H. THOMPSON, *Business Manager*, CHICAGO.

Chicago: Transportation Bldg. Cleveland: Citizens' Bldg.
Washington: Home Life Bldg.
London: Queen Anne's Chambers, Westminster.

ROY V. WRIGHT, *Editor*
R. E. THAYER, *Managing Editor*

C. B. PECK, *Associate Editor* A. F. STUEBING, *Associate Editor*

Entered at the Post Office at New York, N. Y., as mail matter of the
second class.

Subscriptions, including the eight daily editions of the *Railway Age Gazette* published in June in connection with the annual conventions of the Master Car Builders' and American Railway Master Mechanics' Associations, payable in advance and postage free: United States, Canada and Mexico, \$2.00 a year; Foreign Countries (excepting daily editions), \$3.00 a year; Single Copy, 20 cents.

WE GUARANTEE, that of this issue 9,036 copies were printed; that of these 9,036 copies 7,687 were mailed to regular paid subscribers, 112 were provided for counter and news companies' sales, 529 were mailed to advertisers, exchanges and correspondents, and 708 were provided for new subscriptions, samples, copies lost in the mail and office use; that the total copies printed this year to date were 18,136, an average of 9,068 copies a month.

The RAILWAY MECHANICAL ENGINEER is a member of the Audit Bureau of Circulations.

VOLUME 91

FEBRUARY, 1917

NUMBER 2

CONTENTS

EDITORIALS:

We Want to Know.....	61
Valuation in the Mechanical Department.....	61
Analyze Your Engine Failures.....	61
Freight Car Repair Track Earnings.....	61
The Cost of Equipment Failures.....	62
Locomotive Tractive Effort Formulas.....	62
A Neglected Function of the Testing Department.....	62
Car Inspectors Need Better Training.....	63
New Books.....	63

GENERAL:

Virginian Triplex Locomotive.....	64
A Pilot Snow Plow.....	66
Convention Attendance a Big Asset.....	67
The Kiesel Locomotive Tractive Effort Formula.....	69
Exhaust Separator for Headlight Service.....	70
Walschaert Valve Gear Design.....	71
Mechanical Design of Electric Locomotives.....	75
Peat Powder as a Locomotive Fuel.....	76

CAR DEPARTMENT:

Anti-Friction Bearings a Remedy.....	77
Passenger Car Works.....	77
Educate the Men.....	78
Car Inspection of Vital Importance.....	79
Car Department Apprentices.....	84
Steel Passenger Cars for D. & H.....	85

SHOP PRACTICE:

A Furnace for Case-hardening with Cyanide.....	91
Sand Blast for Cleaning Flue Sheets.....	91
The Efficiency Engineer?.....	92

Turning Bolts in a Bolt Cutter.....	93
Pneumatic Carrier.....	93
Prolonging the Life of Fireboxes.....	94
A Tool for Forming Rod Bushings.....	94
Some Information on Arc Welding.....	95
Notes on Roundhouse Supervision.....	97
Method of Making Tube Expanders.....	98
Device for Reboring Distributing Valves.....	98
A Foreman Who Fired Himself.....	99
Ladder Riveting Machine.....	102

NEW DEVICES:

Heavy Duty Car Wheel Grinder.....	103
File Cleaning and Sharpening Machine.....	103
A Collapsing Tap.....	104
Power Fast Traverse for Milling Machine Tables.....	104
Reversible Eccentric and Side Rods.....	105
Union Automatic Train Pipe Connector.....	105
Filter and Grease Extractor.....	107
Pedrick Horizontal Boring Machine.....	107
Radial Drill.....	108
Automatic Freight Car Door Lock.....	108
Heavy Duty Engine Lathe.....	109
The Details of an Arch Tube Cleaner.....	109

NEWS DEPARTMENT:

Notes.....	110
Meetings and Conventions.....	111
Personals.....	112
Supply Trade Notes.....	113
Catalogues.....	116

The House of Representatives recently passed the post-office appropriation bill without the provision for an increase in the rates for carrying second-class mail matter.

In a fire at Lima, O., on January 19, the main building of the car shops of the Cincinnati, Hamilton & Dayton was destroyed; estimated loss, including 10 passenger cars, \$200,000.

The Southern Pacific Lines in Texas are now using the self-locking Tyden freight car seal. Lead and tin seals requiring the use of a seal press have been abandoned, and agents and conductors are called upon to be able to report, at the end of a year, the results of their experience with the new seal, so that it will be possible to make a comprehensive report of the results of the year's trial.

Inter-car telephones were used recently on the Pacific Coast Special, which made the trip from San Francisco to

the convention of Willys-Overland dealers at Toledo, Ohio. A daily newspaper called the Overland Daily Speed was published en route, being edited by newspaper men aboard the train. The printing work was done on a small press in the baggage car.

A new dining car has been placed in service on the Illinois Central with improved sanitary features. This car is provided with an efficient ventilating system for the kitchen which prevents all dust and cinders from entering the car and still provides proper ventilation. The receptacle for milk and cream is kept clean by means of a continuous flushing arrangement, and the fish is kept in a separate refrigerator. There is a fan to drive cooking odors to the rear platform, keeping them out of the dining room. The car has no platforms and there are tables for thirty-six passengers. Cars of this type cost about \$30,000 each, including the special equipment.

INCREASE IN M. C. B. REPAIR BILLS

The executive committee of the M. C. B. Association has issued circular No. 31 authorizing a 25 per cent increase to the face value of all car repair bills. The circular states: "Owing to the unusually large increase in the cost of labor and materials the executive committee is of the opinion that the addition of a certain percentage to car repair bills is justifiable, and therefore authorizes that, effective January 1, 1917, and continuing until October 1, 1917, unless otherwise modified, twenty-five (25) per cent shall be added to the face value of all car repair bills."

CARS AND LOCOMOTIVES ORDERED IN JANUARY

Orders for cars and locomotives were reported in January as follows:

	Locomotives	Freight cars	Passenger cars
Domestic	164	5,706	45
Foreign	168	3,400	..
Total	332	9,106	45

Among the important locomotive orders were the following:

Buffalo, Rochester & Pittsburgh.....	22	Mallet	American Pacific
	3	Switching	American
New York, New Haven & Hartford...	50	Santa Fe	American
Northern Pacific.....	20	Santa Fe	American
	5	Mallet	American
Southern Pacific	24	Santa Fe	American
	9	Switching	Baldwin
Union Pacific	10	Mikado	Lima
British War Office.....	75	Prairie	Baldwin
	50	Consolidation	Baldwin
Chemin de Fer du Midi (France)....	40	Consolidation	American

The freight car orders included among others the following:

Chicago, Burlington & Quincy.....	1,500	Gondola	Pressed Steel
Chicago, Milwaukee & St. Paul.....	1,000	Gondola	Tacoma shops
Illinois Central	500	Automobile	Standard Steel
Northern Pacific	500	Refrigerator	Pullman
	500	Gondola	Pressed Steel
Virginian	1,000	Hopper	Pressed Steel
French State Railways.....	3,000
Java State Railway	400	Standard Steel

The 45 passenger cars included an order placed by the Boston Elevated for 35 subway cars with the Pressed Steel Car Company and an order for 10 express cars placed by the Delaware, Lackawanna & Western with the Pullman Company.

MEETINGS AND CONVENTIONS

Central Railway Club Dinner.—The annual dinner of the Central Railway Club will be held at Buffalo on March 8. Among the speakers of the evening will be Major-General Goethals, president of the Panama Railway Company and the Panama Railroad Steamship Lines. A committee, with J. L. Randolph, vice-president of the Economy Devices Corporation, as chairman, is arranging for a special train from New York City to Buffalo on the evening of March 7.

The June Mechanical Conventions.—The secretary of the Railway Supply Manufacturers' Association on January 13 sent out official circular No. 1 giving details concerning the annual exhibit of the association to be held at Atlantic City,

June 13 to 20, in connection with the meetings of the Master Mechanics' and Master Car Builders' Associations. With the circular were enclosed applications for space. The assignment of space will be made February 23 at the office of the association in Pittsburgh. The circular notes that "From early indications there will be an unusual demand for space. Those who apply promptly will have the advantage of location."

General Foremen's Association.—The next annual convention of the International Railway General Foremen's Association will be held at the Hotel Sherman, Chicago, Ill., September 4, 5, 6 and 7, 1917. Committees have been appointed to report on the following subjects:

Engine Failures, Causes and Responsibilities. What Constitutes a Failure? W. R. Meeder, chairman, Chicago & Eastern Illinois, Danville, Ill.

Methods of Meeting the Requirements of Federal Inspection Laws. J. B. Wright, chairman, Hocking Valley, Columbus, Ohio.

Alignment of Locomotive Parts to Insure Maximum Service with Minimum Wear. B. F. Harris, chairman, Southern Pacific, Oakland, Cal.

What Interest Has the Locomotive Foreman with Car Department Matters? Charles Hobbs, chairman, Ann Arbor, Owosso, Mich.

The following list gives names of secretaries, dates of next or regular meetings and places of meeting of mechanical associations:

- AIR BRAKE ASSOCIATION.—F. M. Nellis, Room 3014, 165 Broadway, New York City. Convention, May 1-4, 1917, Memphis, Tenn.
- AMERICAN RAILROAD MASTER TINNERS', COPPERSMITHS' AND PIPEFITTERS' ASSOCIATION.—O. E. Schlink, 485 W. Fifth St., Peru, Ind.
- AMERICAN RAILWAY MASTER MECHANICS' ASSOCIATION.—J. W. Taylor, Karpen Building, Chicago. Convention, June 13-15, 1917, Atlantic City, N. J.
- AMERICAN RAILWAY TOOL FOREMEN'S ASSOCIATION.—R. D. Fletcher, Belt Railway, Chicago.
- AMERICAN SOCIETY FOR TESTING MATERIALS.—Prof. E. Marburg, University of Pennsylvania, Philadelphia, Pa.
- AMERICAN SOCIETY OF MECHANICAL ENGINEERS.—Calvin W. Rice, 29 W. Thirty-ninth St., New York.
- ASSOCIATION OF RAILWAY ELECTRICAL ENGINEERS.—Joseph A. Andreucetti, C. & N. W., Room 411, C. & N. W. Station, Chicago.
- CAR FOREMEN'S ASSOCIATION OF CHICAGO.—Aaron Kline, 841 Lawlor Ave., Chicago. Second Monday in month, except June, July and August, Hotel La Salle, Chicago.
- CHIEF INTERCHANGE CAR INSPECTORS' AND CAR FOREMEN'S ASSOCIATION.—W. R. McMunn, New York Central, Albany, N. Y.
- INTERNATIONAL RAILROAD MASTER BLACKSMITHS' ASSOCIATION.—A. L. Woodworth, C. I. & D., Lima, Ohio.
- INTERNATIONAL RAILWAY FUEL ASSOCIATION.—J. G. Crawford, 547 W. Jackson Blvd., Chicago. Convention, May, 1917, Chicago.
- INTERNATIONAL RAILWAY GENERAL FOREMEN'S ASSOCIATION.—William Hall, 1126 W. Broadway, Winona, Minn. Convention, September 4-7, Hotel Sherman, Chicago, Ill.
- MASTER BOILERMAKERS' ASSOCIATION.—Harry D. Vought, 95 Liberty St., New York. Convention, May 23-25, 1917, Richmond, Va.
- MASTER CAR BUILDERS' ASSOCIATION.—J. W. Taylor, Karpen Building, Chicago. Convention, June 18-20, 1917, Atlantic City, N. J.
- MASTER CAR AND LOCOMOTIVE PAINTERS' ASSOCIATION OF U. S. AND CANADA.—A. P. Dane, B. & M., Reading, Mass.
- NIAGARA FRONTIER CAR MEN'S ASSOCIATION.—E. N. Frankenberger, 623 Brisbane Building, Buffalo, N. Y. Meetings, third Wednesday in month, New York Telephone Bldg., Buffalo, N. Y.
- RAILWAY STOREKEEPERS' ASSOCIATION.—J. P. Murphy, Box C, Collinwood, Ohio.
- TRAVELING ENGINEERS' ASSOCIATION.—W. O. Thompson, N. Y. C. R. R., Cleveland, Ohio.

RAILROAD CLUB MEETINGS

Club	Next Meeting	Title of Paper	Author	Secretary	Address
Canadian	Feb. 13, 1917	The Chilled Iron Car Wheel: Its Past, Present and Future.	Geo. W. Lyndon.	James Powell.....	P. O. Box 7, St. Lambert, Que.
Central	Mar. 8, 1917	Annual Dinner; Address by Major-General G. W. Goethals		Harry D. Vought.....	95 Liberty St., New York.
Cincinnati	Feb. 13, 1917	Demonstration of the Automatic Stop.	Julian Beggs	H. Boutet.....	101 Carew Bldg., Cincinnati, Ohio.
New England.....	Feb. 13, 1917	Electrical Night		Wm. Cade, Jr.....	683 Atlantic Ave., Boston, Mass.
New York	Feb. 16, 1917	Cost Accounting	Henry Lehn	Harry D. Vought.....	95 Liberty St., New York.
Pittsburgh	Feb. 23, 1917	Valuation	James P. Nelson..	J. B. Anderson.....	207 Penn Station, Pittsburgh, Pa.
Richmond	Feb. 12, 1917	Locomotive Inspection Laws and Rules.		F. O. Robinson.....	C. & O. Railway, Richmond, Va.
St. Louis	Feb. 9, 1917	Their Purposes and Accomplishments.	Frank McManamy	B. W. Frauenthal..	Union Station, St. Louis, Mo.
Sou'th'n & S'w'rn.	Mar. 15, 1917			A. J. Merritt.....	Box 1205, Atlanta, Ga.
Western	Feb. 19, 1917			Jos. W. Taylor.....	1112 Karpen Bldg., Chicago.

PERSONAL MENTION

GENERAL

PERSIFER FRAZER SMITH, JR., whose appointment as general superintendent of motive power of the Pennsylvania Lines West, with headquarters at Pittsburgh, Pa., was announced in these columns last month, was born August 1, 1870, at West Chestnut, Pa. After leaving high school he entered Warralls Technical Academy, from which he graduated in June, 1887. In October, 1887, he was employed by the Pennsylvania as an apprentice in the shops at Altoona, Pa. After several minor promotions he was appointed assistant road foreman of engines on the Pittsburgh division in February, 1892, and in August, 1893, was transferred with same title to the western division of the Pittsburgh, Ft. Wayne & Chicago. On February 1, 1895, he was appointed assistant master mechanic at the Ft. Wayne (Ind.) shops, and in November, 1896, was promoted to master mechanic of the Crestline (Ohio) shops and the Toledo division. From January 1, 1900, to December 31, 1911, he was consecutively master mechanic of the Logansport, Dennison and Columbus shops of the Pittsburgh, Cincinnati, Chicago & St. Louis. On January 1, 1912, he was appointed superintendent of motive power, of the central system, western lines, which position he held until his recent appointment, noted above.

OLIVER P. REESE, the announcement of whose appointment as superintendent of motive power of the Central system, Pennsylvania Lines West, with office at Toledo, Ohio, was made in these columns last month, was born on May 29, 1876, at Louisville, Ky. He graduated from Purdue university in 1898, and the following August entered railway service as an apprentice with the Louisville & Nashville, at Louisville, Ky. From January, 1900, to September of the same year he was a draftsman in the Pennsylvania shops at Allegheny, Pa., and from September, 1900, to September, 1901, he was engaged on special work for this same company at its shops at Ft. Wayne, Ind. In September, 1901, he was made a special apprentice, and in August, 1903, appointed gang foreman in the shops at Allegheny,



P. F. Smith, Jr.



O. P. Reese

Pa. From February, 1904, to December the same year he was foreman of tests for the company at the St. Louis world's fair, following which he was appointed motive power inspector. From May, 1904, to May, 1906, he was general division foreman, and in June, 1908, was promoted to division master mechanic. In June, 1910, he became assistant engineer of motive power, and in September, 1911, was advanced to master mechanic. On May 31, 1915, he was appointed assistant engineer of motive power in the office of the general superintendent of motive power, which position he held at the time his appointment as superintendent of motive power became effective, as noted above.

W. H. DOOLEY, formerly superintendent of motive power of the Alabama Great Southern, the Cincinnati, New Orleans & Texas Pacific, and the Harriman & North Eastern, has been appointed superintendent of motive power of the Southern Railway, Lines West, with headquarters at Cincinnati, Ohio.

W. S. MURRIAN, superintendent of motive power of the Southern Railway, with headquarters at Knoxville, Tenn., will take the position of superintendent of motive power, both for the Lines East and West, with headquarters as heretofore, at Knoxville, Tenn.

GROVER C. NICHOLS, whose appointment as superintendent of motive power and equipment of the Alabama, Tennessee & Northern, with headquarters at York, Ala., has already been announced in these columns, was born on September 19, 1885, at Jonesboro, Ark., and was educated in the public high schools. He began railway work on June 9, 1902, as call boy on the St. Louis Southwestern. The following year he became machinist apprentice, and from June, 1907, to March, 1911, he was machinist. He was then appointed master mechanic of the Jonesboro, Lake City & Eastern, at Jonesboro, Ark., remaining in that position until October, 1912; the following month he returned to the service of the St. Louis Southwestern as roundhouse foreman. On September 1, 1913, he was appointed master mechanic of the Alabama, Tennessee & Northern, which position he held until his recent promotion as superintendent of motive power and equipment on the same road.

E. C. SASSER, superintendent of motive power of the Southern Railway, with headquarters at Washington, D. C., has been appointed superintendent of motive power of the Lines East, with headquarters at Charlotte, N. C.

ORVILLE C. WRIGHT, assistant engineer of motive power, Northwest system, of the Pennsylvania Lines West, at Ft. Wayne, Ind., has been appointed assistant engineer of motive power of the Lines West, with office at Pittsburgh, Pa.

MASTER MECHANICS AND ROAD FOREMEN OF ENGINES

C. GRIBBINS has been appointed division master mechanic of the Smiths Falls division of the Canadian Pacific with office at Smiths Falls, Ont., succeeding F. Ronaldson, promoted.

W. B. JOHNSON has been appointed master mechanic of district 6, Intercolonial division of the Canadian Government Railways, with headquarters at Truro, N. S.

LLOYD B. JONES, formerly assistant engineer of motive power of the Pennsylvania Railroad at Williamsport, Pa., has been appointed master mechanic with headquarters at Verona, Pa. Mr. Jones was born on September 30, 1892, at West Grove, Pa. He graduated from Cornell University in 1904 and began railroad work on July 22, 1904, with the Pennsylvania Lines West as a special apprentice. He became a locomotive fireman on November 9, 1906, and was appointed enginehouse foreman at Logansport, Ind., on February 1, 1907. On July 1, 1908, he entered the

office of the superintendent of motive power at Columbus, Ohio, as assistant electrician and on March 1, 1910, was made electrician of the Vandalia Railroad. From February 28, 1911, to February 1, 1912, he was inspector at the Columbus shops and then did special work in the office of the superintendent of motive power until December 1, 1912, when he again became an inspector in the Columbus shops. On January 1, 1913, he was appointed assistant engineer of motive power of the Central system, later being transferred to the Southwestern system. On May, 1, 1916, he was transferred to the Pennsylvania Railroad, becoming assistant engineer of motive power at Williamsport, Pa., holding that position at the time of his recent promotion to the position of master mechanic.

GEORGE J. RICHERS, formerly enginehouse foreman of the Pennsylvania Railroad at West Brownsville Junction, has been appointed assistant master mechanic with office at Verona, Pa. Mr. Richers was born on June 10, 1893, and was educated at the University of Pennsylvania. He entered railroad service on August 3, 1900, as a messenger in the office of the chief motive power clerk, becoming a regular apprentice on September 16, 1901, and was subsequently promoted to several minor positions in the Altoona machine and car shops. On December 27, 1910, he was appointed a member of the Efficiency Committee of the Philadelphia Terminal division, and on October 9, 1912, was made inspector in the office of the master mechanic of the Pittsburgh division. He became enginehouse foreman at West Brownsville Junction on August 16, 1915, holding that position until his recent appointment as assistant master mechanic.

SHOP AND ENGINEHOUSE

J. L. JAMIESON has been appointed foreman of locomotives of the Medicine Hat division, Alberta district of the Canadian Pacific at Medicine Hat, succeeding W. J. McLean, transferred.

ARTHUR T. KUEHNER, formerly district motive power inspector of the Baltimore & Ohio, has been appointed general foreman at Riverside, Md.

PURCHASING AND STOREKEEPING

E. G. GOODWIN has been appointed fuel agent of the Southern Railway Lines East, with headquarters at Knoxville, Tenn.

EUGENE McAULIFFE, general fuel agent of the St. Louis-San Francisco, with office at St. Louis, Mo., has resigned, effective February 1, to become vice-president of the West Kentucky Coal Company of Paducah, and Sturgis, Ky. He was born in 1866, at London, Eng., coming to this country as a young boy. In 1884 he entered railway service with the Northern Pacific as a shop apprentice. Later he was advanced to locomotive fireman and then to engineer with this same company. Subsequently he spent five years in the mechanical and operating departments of various railroads in the United States and Mexico, and in 1894 entered the service of the Kansas City, Ft. Scott & Memphis, now a part of the Frisco system, being appointed fuel agent in 1903. In 1908 he was appointed general fuel agent of the Chicago, Rock Island & Pacific, the St. Louis-San Francisco and the Chicago & Eastern Illinois jointly, at about the same time becoming president of the Brazil Block Coal Company, and in 1910 general manager of the Crawford Valley Mining Company. He organized the Railway Fuel Association, of which he was president in 1908 and 1909.

H. SHOEMAKER, formerly district storekeeper of the Baltimore & Ohio, at Wheeling, W. Va., has been appointed district storekeeper of the Southwest district and the Cincinnati, Hamilton & Dayton with headquarters at Cincinnati, Ohio, succeeding H. P. McQuilkin, promoted.

SUPPLY TRADE NOTES

Frederick S. Bennett, for many years associated with the Railroad Gazette and the Railway Review, died in Chicago, Ill., January 19.

John O. Pew, for four years president and general manager of the Youngstown Iron & Steel Company, Youngstown, Ohio, has resigned.

C. L. Mellor, formerly western representative of the Barco Brass & Joint Company, Chicago, has been appointed manager of sales, with headquarters in Chicago.

L. W. Miller, formerly eastern representative of the Barco Brass & Joint Company, Chicago, has resigned to accept a position with Fahh-McJunkin, Inc., New York City.

Charles Cyrus Ramsey, president of the Crucible Steel Company of America, died January 11, at Pittsburgh, following an attack of pneumonia, contracted five weeks ago.



C. C. Ramsey

Mr. Ramsey was born in Allegheny City, February 25, 1862. He started his business career as stenographer in the office of the assistant general freight agent of the Pennsylvania Company. When 23 years of age, he left the employ of the railroad and became a stenographer in the office of Park Brothers & Co., Ltd., then the largest manufacturers of crucible steels in this country. Gradually he rose from one position to another until he became manager of their

Philadelphia branch, and then manager of the New York branch in charge of the entire eastern district. He held this position until the organization of the Crucible Steel Company was completed in 1900, when Park Brothers & Co., Ltd., or rather their successor, the Park Steel Company, was absorbed into the present Crucible Steel Company of America. Serving for a time with R. E. Jennings in the management of the eastern business of the company, he was shortly made, on Mr. Jennings' retirement, fourth vice-president and permanent manager of the eastern office. In the winter of 1910 the death of Frank B. Smith, then president of the Crucible Steel Company, caused a vacancy. Mr. Ramsey was called to Pittsburgh as assistant to the president, which latter office was then temporarily held by Mr. DuPuy. The board soon recognized Mr. Ramsey's ability and in July, 1910, he was unanimously elected president of the Crucible Steel Company, and, soon thereafter, of its affiliated companies; these positions he held until his death.

W. W. Darrow, secretary of the Camel Company, manufacturers of railway specialties and supplies, with general offices at Chicago, has been appointed general manager of this company, effective January 1.

The sale of the properties of the Wharton Steel Company to J. Leonard Replogle, vice-president of the American Vanadium Company, was completed January 13. The properties include two large blast furnaces and a smaller one, the Wharton Northern Railroad, the Hibernia mine

near Wharton, N. J., and smaller mines in the same group, including the Allen-Teabo, Orchard, Scrub Oaks and Mount Pleasant—in all about 5,000 acres of iron ore lands.

At a meeting of the board of directors of the Crucible Steel Company of America, held in Pittsburgh January 16, Herbert DuPuy, chairman of the board, was also elected temporary president. He will continue to hold the office of chairman.

H. T. Armstrong, for the past three years connected with the sales department of the American Locomotive Company at Montreal, Can., has been assigned to the sales department of this company's Chicago office, calling on all railroads and industrial concerns using locomotives in western territory.

The circuit court of appeals for the second district has handed down a decision in the case of Safety Car Heating & Lighting Company v. Gould Coupler Company, in which it holds that the Gould "Simplex" system of electric car lighting is not an infringement of the H. G. Thompson patent No. 1,070,080, owned by the Safety Car Heating & Lighting Company.

H. D. Savage, vice president of the American Arch Company, in addition to his present duties, has been appointed manager of sales of the industrial department of the Locomotive Pulverized Fuel Company, with office at 30 Church street, New York. Mr. Savage was born in 1880 at Memphis, Tenn. He was educated in the public schools at Ashland, Ky., and at the Kenyon Military Academy. In 1897 he entered the manufacturing department of the Ashland Fire Brick Company and served in various capacities up to 1904, at which time he was appointed manager of sales. In 1914 he was elected vice president of the American Arch Company, which position he will still hold in addition to his new appointment, above noted.



H. D. Savage

At a meeting of the board of directors of the American Locomotive Company, held January 17, the following officers were elected, effective February 1: Columbus K. Lassiter, vice-president in charge of manufacture; Harry B. Hunt, assistant vice-president in charge of manufacture; James D. Sawyer, vice-president in charge of sales; Joseph Davis, vice-president and comptroller.

Waldo H. Marshall, whose resignation as president of the American Locomotive Company was accepted a few weeks ago, after a long fight had been waged against the management by Isaac Cate, of Baltimore, and other minority stockholders, has become associated with J. P. Morgan & Co. In his new position he will assist E. R. Stettinius, the partner in charge of the export department.

Ellis J. Hannum, secretary of the Newton Machine Tool Works, Inc., Philadelphia, died January 7. Mr. Hannum had been in the service for 29 years. He entered the employ of the company as a boy and was most closely associated with the drafting and engineering departments. During the past two years, failing health caused him to give up active engineering work and during this time he acted in an advisory capacity to the advertising department.

W. L. Batt has been made sales manager of the Hess-Bright Manufacturing Company, Philadelphia, and will have entire charge of its sales after February 1, 1917. Mr. Batt has been connected with the Hess-Bright manufacturing organization since its early days, and has for many years been engaged in doing much of the pioneer work that was necessary to develop the industry in this country.

Stowell Cortland Stebbins, western sales and advertising manager of the Lansing Company, Lansing, Mich., the announcement of whose election as secretary was made in these columns last month, was born at Lansing, Mich., July 29, 1886. After leaving high school he attended the Michigan Agricultural College, and the University of Michigan at Ann Arbor, Mich. In July, 1910, he entered the employ of the Lansing Company as an assistant timekeeper, and a year later was transferred to the sales department. In 1912 he was appointed western sales manager, and in 1914 he also took over the duties of advertising manager, holding these two positions until his present election, as noted above. In addition he was also elected a member of the board of directors. He succeeds Harry E. Moore, elected vice-president.



S. C. Stebbins

Walter J. McBride, formerly president of the Haskell & Barker Car Company, Michigan City, Ind., died at his home in Chicago, January 18, at the age of 56. He was born on May 2, 1861, and entered commercial life at the age of 16, as an office boy with the Peninsula Car Company, Detroit, Mich. He was with that company for nearly 15 years and at the time of its consolidation with the Michigan Car Company, Detroit, was elected secretary of the new corporation. In 1899, when the American Car & Foundry Company was organized, he was elected auditor and shortly thereafter promoted to assistant to the president and later to vice-president and general manager. In 1907, he resigned as vice-president of the American Car & Foundry Company to become associated with the late John H. Barker, president of the Haskell & Barker Car Company as vice-president. At the death of John H. Barker, he became president of the company and continued in that position until the sale of the corporation to the present owners in 1916.



W. J. McBride

Effective January 1, 1917, the business heretofore conducted under the name of the Railway Supply & Equipment Company, of Atlanta, Ga., will be continued under the name

of the Bradford Draft Gear Company, the Bradford Draft Gear Company having purchased and taken over the business of the Railway Supply & Equipment Company. All contracts and agreements with the Railway Supply & Equipment Company will be taken care of by the Bradford Draft Gear Company. The management of the new company will be the same as the old.

J. G. Blunt, superintendent of the general drawing room of the American Locomotive Company has been appointed mechanical engineer of that company with headquarters at



J. G. Blunt

Schenectady, N. Y. Mr. Blunt has been in the employ of the company or its predecessors since 1897. He was born April 7, 1868, at Cincinnati, N. Y. He took the mechanical engineering course at the University of Michigan. After spending four years as machinist and draftsman with various manufacturing companies, he accepted a position in 1897 as a draftsman with the Brooks Locomotive Works at Dunkirk, N. Y., and later became chief draftsman of that company. Mr. Blunt has been in the service of the American Locomotive Company or its predecessors continuously since that time. When the engineering work of all the company's plants was consolidated at Schenectady he was transferred to that plant as engineer of the drafting department and later became superintendent of the general drawing room.

Arthur L. Humphrey, first vice-president and general manager of the Westinghouse Air Brake Company, has been elected president of the Union Switch & Signal Company in



A. L. Humphrey

accordance with merger proceedings of the two companies, and will hereafter assume the executive responsibility of both offices. Mr. Humphrey was born in Erie county, New York, but his family moved to Iowa when he was less than a year old. At the age of 14, after the usual amount of country schooling, he struck out for himself, passing successively through the positions of store-hand, cow-boy, substitute cook, machinist apprentice, gang boss, mining engineer and general contractor—all in the new pioneer territory lying between the Missouri river and the Pacific coast. At the age of 22 he organized a general machine shop and foundry in Seattle, which afterwards developed into the present extensive Moran Iron Works. He then went into railroading and became constructing division foreman of the Mojave division of the Central Pacific, then master mechanic and later superintendent of motive power of the Colorado Midland. In

1893, political urgency, due to Populistic activity, caused the business men of Colorado to combine and combat that influence in the Colorado legislature by electing a business man to the state legislature. Mr. Humphrey was chosen and elected, serving two terms, one as speaker of the house. He went back to railway service, however, on the Colorado Southern and in 1899 then went to the Chicago & Alton in 1903 as superintendent of motive power. He became western manager of the Westinghouse Air Brake Company in 1893, general manager in 1905, and vice-president and general manager in 1910. Air brake and block signal development in the control of railroad train movement has become so inter-related from an engineering standpoint that closer co-operation between these two Westinghouse interests has been inevitable for some years and indeed was originally planned by the late George Westinghouse himself. Mr. Humphrey's broad experience as a railroad man qualifies him effectively for the new responsibilities assumed.

Hugh M. Wilson, formerly associated with The Railway Age and for several years its owner, and since 1910 first vice-president of the McGraw Publishing Company, has resigned



H. M. Wilson

from the latter position to devote himself to his personal interests. Mr. Wilson has been in journalistic work during practically his entire business life. His first experience was as city editor of the Jacksonville (Ill.) Daily Journal. He subsequently was reporter on the Minneapolis Evening Star, but in 1889 changed to the technical paper field and joined the staff of the Mississippi Valley Lumberman. With but one brief interruption since he has devoted

his energy and abilities to the object of developing magazines in trade and technical lines. He gained his first experience with railroad papers, as an associate editor of the Northwestern Railroader and shortly after that publication was consolidated with The Railway Age, at Chicago, he was made secretary-treasurer of the new organization. He subsequently became manager of The Railway Age, meanwhile continuing as secretary-treasurer, and was elected president of the company in 1899. In these years, although busily engaged in the business department of the paper, he found much time for editorial work, particularly on news matters relating to the purchase of equipment and supplies. His familiarity with this branch of railroad work soon made him an authority and fitted him for the work he did as secretary of the Railway Supply Manufacturers' Association from 1897 to 1902. His energy was perhaps best displayed by the publication during the International Railway Congress at Washington, in 1905, of a daily edition of The Railway Age, which was designated as the official journal of the congress. Supplementing the praise showered on him by both American and foreign delegates for the success of this enterprise, he was created a chevalier of the Order of Leopold by the King of the Belgians. In 1906 the Wilson Company, with Mr. Wilson as the controlling owner, was organized, taking over The Railway Age and the Street Railway Review, which had just then been purchased and which was changed shortly to the Electric Railway Review and from a monthly to a weekly publication. Two years later Mr. Wil-

son sold both papers. The Railway Age was consolidated with the Railroad Gazette to make the present Railway Age Gazette, while the McGraw Publishing Company purchased the Electric Railway Review and consolidated it with the Street Railway Journal under the name of the Electric Railway Journal. Mr. Wilson immediately went abroad for an extended trip, and on his return in June, 1909, was elected vice-president and a director of the Barney & Smith Car Company, Dayton, Ohio. He continued with the Barney & Smith Car Company until 1910 when he was elected first vice-president of the McGraw Publishing Company, the position he is now relinquishing.

Henry Lindenkohl was, on December 1, appointed engineer of construction of the American Locomotive Company, with headquarters at Schenectady, N. Y. Mr. Lindenkohl was born at Roselle, N. J., on December 26, 1883. He attended the public schools at Elizabeth, N. J., and later entered Stevens Institute of Technology, from which he graduated with the degree of mechanical engineer in 1905. The same year he entered the employ of the American Locomotive Company at Providence, R. I., as inspector of new buildings. In 1908 he was transferred to the general building construction department of the company at Schenectady, N. Y.

The Chicago Car Heating Company, Chicago, announces that, by a recent decision of the commissioner of patents in the interference suit between the Chicago Car Heating Company and the Consolidated Car Heating Company, dating from 1908 over certain vapor heating system patent claims, the contentions of the Chicago Car Heating Company were sustained in all respects. The decision has now become final from which no appeal has been or can be taken, and the Cosper Application (owned by the Consolidated Car Heating Company) has been abandoned, and no patent will be granted to the Consolidated Car Heating Company relating to any matter involved in that interference.

There still remains in litigation the Chicago Car Heating Company's suit against the Gold Car Heating & Lighting Company in the U. S. District Court of New York, for infringement of vapor heating system patents; and also suit of the Chicago Car Heating Company against the Standard Heat & Ventilation Company, in the U. S. District Court of Chicago, for infringement of vapor heating system patents.

The Interstate Iron & Steel Company, Chicago, recently has bought outright the entire property and business of the Grand Crossing Tack Company, Chicago. This purchase gives the Interstate Iron & Steel Company, in addition to its present works, an open hearth steel plant and a blooming mill, as well as a complete line of nails, wire and wire products. Samuel Hale, formerly with the Wisconsin Steel Company, Chicago, and later general manager of the Algoma Steel Corporation, Sault Ste. Marie, Ont., becomes vice-president in charge of the steel division. There will be no other change in the management, S. J. Llewellyn remaining as president and George F. Davie as vice-president and treasurer. The Interstate Iron & Steel Company started in 1905 in a small way with a rolling mill at East Chicago for the manufacture of iron and steel bars and shapes. At that time it had a capacity of about 30,000 tons per year. It has always been active in the railway supply field. With the properties it has recently acquired, and with improvements which will soon be finished, it will have plants having an output of 275,000 tons annually. Its products now include common bar iron, plain and twisted reinforcing bars, refined bar iron, bar iron for car work, engine bolt and stay bolt iron, wrought iron and steel tie plates, and a full line of steel bars, wire rods, wire nails and other wire products. It now has iron rolling mills at East Chicago, Ind.; high carbon steel rolling mills at Marion, Ohio; an open hearth plant and a blooming mill at South Chicago, and a rod mill and wire works at Seventy-ninth street, Chicago.

CATALOGUES

SAWS.—The Simonds Manufacturing Company, Fitchburg, Mass., has issued a 180-page catalogue of its line of saws, knives, files and special steels.

POWER HAMMERS.—The United Hammer Company, Boston, Mass., has issued a small 16-page booklet describing and illustrating its line of Fairbanks power hammers.

PORTABLE TOOLS.—Portable Tools of Chosen Value is the title of a small booklet recently issued by the Stow Manufacturing Company, Binghamton, N. Y., manufacturers of Stow flexible shafting.

MACHINE TOOLS.—The Gisholt Machine Company, Madison, Wis., has recently issued a 16-page booklet containing reprints of a number of full page advertisements that appeared in the American Machinist.

HOSE—ELECTRIC HOISTS.—Bulletins Nos. 129 and E-45, recently issued by the Chicago Pneumatic Tool Company, Chicago, deal respectively with hose, hose couplings and hose clamp tools, and with Duntly portable electric hoists.

LOCOMOTIVE DEVICES.—The Franklin Railway Supply Company, New York, in series E bulletin 600, illustrates and describes the Franklin automatic adjustable driving box wedge, and in series C bulletin 401, McLaughlin flexible conduits.

TRANSIT REFRIGERATION.—A bulletin recently issued by the Refrigerator Car Equipment Company, Chicago, entitled "Waste in Transit Refrigeration Transformed into Efficiency and Profits" describes the company's A B C system of transit refrigeration.

FABROIL GEARS, formerly known as the cloth pinons, form the subject of a profusely illustrated descriptive bulletin No. 48702, of the General Electric Company. Commercial data on "Fabroil" gears and useful information for gear calculations are given in bulletin No. 48703.

WASHING AND COOLING AIR.—A rather attractive booklet, bulletin No. 150, recently issued by the Spray Engineering Company, Boston, Mass., deals with Spraco equipment for washing and cooling air for steam turbine generators. The booklet describes the company's water-spray type of air-washer and cooler, taking up the details of its construction and operation. A number of views of the air-washers are shown in operation and in course of construction.

BALL BEARING HANGERS.—The latest catalogue issued by the S. K. F. Ball Bearing Company, Hartford, Conn., bears the title S. K. F. Self-aligning Ball Bearing Hangers and Pillow Blocks. The booklet contains 48 well illustrated pages and takes up in detail such subjects as Power Saving, the Use of Smaller Motors, Saving in Lubrication and Inspection, Reduced Fire Hazard, etc. Several pages are devoted to tables and curves and engineering data on mounting, lubrication, testing lubricants, felt seats, etc. Announcement is also made of the S. K. F. engineering service.

RAILWAY SPEED RECORDER.—Bulletin No. 263, recently issued by the Chicago Pneumatic Tool Company, illustrates and describes the Boyer railway speed recorder. The bulletin also gives instructions for applying and operating the recorder, and explains that by examining the chart which it makes, the exact speed at which the train passed any point on the road, the number and location of stops, the distance, speed and location of any backward movement that may have been made, can be determined at a glance. Several pages are devoted to the new Boyer speed recorder with clock attachment.

Railway Mechanical Engineer

Volume 91

March, 1917

No. 3

Milling Machine Practice

In the February issue of the *Railway Mechanical Engineer* an announcement was made regarding the competition on milling machine practice.

The field to be covered was purposely made broad enough to permit anyone who is at all interested in the possibilities of this work to contribute. It is our purpose to bring together in a concise form the benefits derived by those of our readers who use this type of machine to good advantage, for the information of those who do not. The milling machine with its various types of cutters has developed very rapidly in the industrial field. It has possibilities in the railway field with which some are not familiar. Some railway mechanical men are seeking knowledge as to its service in railway work. By submitting an article on what is being done on your road you are assisting those who are after this information. You likewise will receive the benefit of the investigations of others who perhaps may have made developments along different lines. Three prizes of \$20 each have been offered for the best articles received at our New York office not later than April 1, 1917.

Motive Power Conditions

The remarkable and exceptional conditions confronting the railways during the past winter has put the mechanical departments to the most severe test

they have had in years. The demand for engines and the exceptional continuity of the cold weather throughout the winter has been a tremendous drain on the power. Those roads which had their power in excellent condition at the beginning of the winter have weathered the storm with but little difficulty, but those which went into the winter with only indifferent power have found it hard to meet the demands of the transportation departments. Every effort should be made to get the power back into shape as promptly as possible. Indications point to a continuance of heavy business conditions. If the United States enters the war against Germany the probabilities are that the demands on the railways will be still greater. We must be ready to meet these demands. Motive power will be needed and should be made ready. Those who are allowing their power to run beyond its time with the hope there will be a break in business soon are very likely to find themselves in a much worse and perhaps a disastrous condition a few months hence.

Locomotive Rod Job Competition

While the making and handling of locomotive main and side rods are as old as the locomotive itself, but little has been said recently regarding this particular work. In order to bring to the attention of our readers and also to make a matter of record the latest practice in this work, we are offering three prizes of \$20 each for the best articles on the rod job from start to finish, which are received in our New York office on or before May 1, 1917. There are three important features to be brought out in these

articles, namely, the methods followed in doing the work, the shop facilities for handling the work and the organization of the rod gang. In explaining the methods followed in doing the work, it is desirable that the reason be given as to why any particular method is followed and the advantages accruing therefrom. Under the head of shop facilities should be explained the special devices used for this work and the arrangement of machines and benches in the shop. This will require illustration in many cases. Where blueprints and photographs are not obtainable, sketches capable of being traced will be accepted. In describing the organization of the gang, the duties of each man in it should be clearly outlined. Those contributions which are not awarded prizes, but which are accepted for publication, will be paid for at our regular space rates.

Keeping Standards Up-to-Date

Several years ago an attempt was made on a number of roads to standardize locomotives to secure economy in shop operation and maintenance. It was found, however, that by adhering to strictly standard locomotives, efficiency in road operation was sacrificed, and the designs have been modified from time to time to suit the changing conditions. Many roads are maintaining designs which would not be considered for new power today and which should be altered at the first opportunity. There are few railroads that do not number among their locomotives some with extremely heavy designs of Stephenson valve gear, which are hard to keep in repair and adjustment. The substitution of an outside gear would, no doubt, save its cost in a short time, yet such changes are seldom made. The application of superheaters to existing equipment is being practiced by many railroads. Some have changed slide valve cylinders for piston valves and the saving has justified the added expense. In car construction the maintenance of the original standards on wooden cars is a fruitful source of expense; the ends and side doors might often profitably be changed, as well as the draft gear. The extent to which the adoption of new standards could be carried and a saving effected thereby, is difficult to determine, but there is no doubt that many roads are neglecting an opportunity for making a considerable saving by rigid adherence to old standards.

Rough Handling of Passenger Trains

Several years ago a great deal of attention was given to the question of handling passenger trains so as to eliminate shocks in starting and stopping. Means were found to reduce the jarring which proved so unpleasant to passengers, and the educational campaign carried on among the enginemen resulted in a marked improvement. Observant passengers will agree that this problem has come back to trouble railroad men again. The introduction of the steel car and the consequent increase in the weight of passenger trains has created new problems in connection with the handling of trains, and it is doubtful whether the methods which produced such good results before will be of any avail

in dealing with the present situation. Passenger trains weighing more than 1,000 tons are not uncommon, and the high starting resistance, when combined with grade resistance, often makes it impossible to start trains without taking the slack. Even where there is no adverse grade to contend with the brakes often fail to release as they should, making it impossible to start a train smoothly.

The situation is certain to give trouble and vigorous methods should be taken to find the source of the difficulty and eliminate the undesirable conditions. Generally fairly smooth stops can be made, the problem at the present time being to do away with the difficulty experienced in starting without taking the slack. The reduction of the frictional resistance of starting by the application of roller bearings is a possible solution, but this will probably not be considered until more attention has been given to the foundation brake rigging. When the problem of rough handling came up before it was successfully met by the road foreman. The present trouble arises from other causes, and the designer and the car repair man must find a way to overcome it.

Railroad Fuel Organization

There are four important items to be considered in any railroad fuel organization which must be handled in sequence in order that the best results may be obtained. Inspection of the coal at mines comes first. Next is the handling of the coal after it has been received by the road; then the education of the employees who use the coal, and last, the facilities and assistance these employees are given in the matter of well maintained equipment to encourage them in getting the most out of the fuel.

It is only by careful and efficient inspection that the proper grade of coal will be obtained from the mines. The inspector is a very important unit in the fuel organization. His duties are broad. He not only must see that the road is receiving the grade of coal it contracts for, but must check the weights, see that the coal is properly loaded in cars, watch the car supply and study the conditions at the mines in order to protect his road against any unforeseen occurrence that may interfere with its regular supply of fuel.

After the road has received its coal properly sized, it must handle it economically and without deterioration. The care with which the inspector at the mines watches the sizing of the coal will be of no benefit if care is not taken to maintain this size while handling it at the coaling stations. The cost of handling and the facilities for unloading the coal from the cars and reloading it onto the locomotive tender is an important matter. Careful records should be kept for comparison and where sufficient coal is handled, a study of the coaling station facilities should be made to determine the most economical method of handling without undue breaking up of the coal lumps. Where modern coaling stations are not used many roads have their coal handled by contractors. Those roads which have well organized fuel departments have found that considerable money can be saved in the cost of handling by operating these stations themselves, and that better results generally can be obtained after the coaling station crews have been carefully instructed. These stations should be under the charge of inspectors whose sole duties should be to see that the coal is properly and economically handled.

In the educational work the employees that handle the coal at the stationary plants should not be neglected. Considerable has been done already to educate the engine crews. Various methods are in effect, such as holding meetings at different engine terminals over an entire system, at which lectures are given and moving pictures displayed concerning the entire subject of fuel combustion. At these meetings the men are encouraged to ask questions or suggest methods by which they think fuel conditions can be improved. While such lectures and meetings are of considerable advantage,

the best results will be obtained by road instruction. A sufficiently large number of fuel supervisors should be assigned to instruct the engine crews in the matter of proper firing and general engine operation on the road. A man will learn much faster by being *shown* how to do his work than he will be by being *told* how to do it. More weight will be given the instructor's words when he is able to prove his statements by actual demonstrations. The number of supervisors should be sufficiently large in order that all engine crews may be handled often enough to keep their interest alive in the matter of fuel economy. The supervisor should be as free with his compliments as he is with his criticisms and every opportunity should be taken to impress upon the fireman that proper firing and the economical use of fuel saves his back as well as the company's coal bill.

It is human nature for a man to become discouraged and revert to his old practices, if it is found that he is not being given the proper support in doing that which is requested of him. No matter how perfect the instruction may be or how apt the pupil may be, if the materials and engines with which he has to work are not such that a creditable showing can be made, he is very liable to lose interest in his work. It is of prime importance, therefore, that the engines be well maintained, free steamers, and that care be given to provide the proper and standard grade of fuel. There is no question but that better results will be obtained where engines are assigned to specific crews. Where this is done the crews will take greater pride in getting the most out of the power, and will be more liable to see that their engines are properly maintained, so that they may head the list in locomotive performance. The supervisors of fuel economy can gain the support of the engine crews by co-operating with them in having the engines properly maintained.

Co-operation in Valuation Work

The tentative valuations of a few roads which have now been made public by the Interstate Commerce Commission show that the value of the property under the control of the mechanical department is about 20 per cent of the value of the entire property of the railroads. The total amount involved in this valuation is extremely large and it is important that no item should be overlooked. In most of the discussions of the valuation of the railroads great stress has been laid on the work of the engineering department and but little attention paid to the mechanical department.

The great variety of the material to be valued and the meagreness of the available data on the subject make the work complex and difficult. The railroads in general have never before been called upon to handle a problem at all similar to that presented by the Federal valuation and the development of an effective organization to handle it is a difficult matter. The roads which have completed the work can be of great service to those just starting. The first inspection of the shop and motive power is extremely important and extra care bestowed on it will greatly facilitate the final calculations.

All those concerned in the work should bear in mind that the final result is based upon the "condition per cent" which is determined in this inspection. In the inspection of locomotives and cars particular stress should be laid on the necessity of securing full and complete records of the additions and betterments applied since the equipment was purchased. A search through the mechanical department files will often bring to light records of expenditures which otherwise would have been overlooked and this should be done before the inspection is made. In valuing the shop machinery and tools, the gages, jigs and special appliances which have been built in the company's shops should be carefully appraised. Drawings and blueprints represent a large investment which should not be neglected.

In certain sections of the country the railway mechanical valuation engineers have met to discuss the methods used in doing the work. Such conferences will be of great assistance. For the benefit of the roads whose representatives will not be able to attend meetings of this sort wide publicity should be given to the methods which have been developed for making the valuation of the mechanical department as nearly complete and exact as possible.

Conserve the Shop Forces

For the past year the mechanical departments of the railways have had considerable difficulty in holding and obtaining sufficiently large forces to

operate their shops to the capacity the present heavy business demands. Most of the shop craftsmen have been tempted to leave the railroads in response to the flattering offers, which at best are only temporary, of the industrial shops which have benefited by the "war prosperity." Some have accepted these offers while others, preferring the steady work offered by the railroads, have remained. Undoubtedly those that chose the latter course were the wiser. But little can be gained by jumping from place to place even though the wages for a time may be better. The new men in the shop should be made to realize this.

It should be the duty of the shop officers to interest themselves in the personal welfare of the men under them. It should be the duty of every railroad to make the living conditions of their shop men as comfortable as possible. Efforts should be made to make the work congenial for the men and keep them satisfied with their work. Money spent for bringing employees into closer relationship with their employers is well invested. The men should be made to feel that they are a necessary part of the railroad for which they work and that they are a permanent unit in the organization. No shop can be efficiently operated which depends on "floaters" to do the work. The shop men are getting excellent wages and are working full time and many of them are getting considerable overtime. Why not caution them now against extravagance and encourage them to save some of their money for the proverbial "rainy day." All business has its "ups and downs" and it was but a short time ago that business was decidedly "down." With the proper kind of encouragement the men could be educated to prepare themselves for these depressions. With money in the bank they will be able to tide over hard times with less discomfort and they will be far less liable to drift away from their steady jobs. Missionary work along these lines will not only help the men, but it will also help keep the shop forces intact.

Light Reciprocating Parts for Locomotives

Of the many refinements in locomotive design, that of light reciprocating parts is the one which has been given the least consideration by most railroads.

And it is the refinement that, on account of the heavy engines being built at the present time, is deserving of very careful study by all railway mechanical engineers. There is a tendency on some roads to wait a few years in order to reap the benefits of the studies made of this subject by other roads. Still other roads question the practicability of using heat-treated metal in locomotive service on account of the troubles experienced by some roads that have been progressive enough to attempt the use of this material. In either case, however, the "watchful-waiting" road is the loser. It either must use locomotives of light weight at a sacrifice of economy in operation, or it must subject its roadbed and bridges to undue punishment. At the same time it is losing the experience necessary to successfully handle heat-treated steel, which eventually it will have to acquire.

Some roads have been forced into using light reciprocating

parts by the engineering department. Abusive treatment of track has led to investigations which have shown that rail pressures above 80,000 lb. are being produced by some locomotives. On other roads the mechanical department has been able to "get away" with engines on which a considerable amount of counterbalance has been left off, simply because it was inconvenient to put it on. On still another road it is the opinion of the mechanical department that the large counterbalance necessary on some engines is responsible for some of its rod failures.

If there is any doubt as to the practicability of the use of heat-treated steel, a study should be made of the automobile industry. The automobile makers have, however, only been able to use this material after careful study and experimentation. Likewise the railroads will only be able to use it successfully after they have carefully studied the methods of treating the steel. At the present time this material is the only means aside from balanced compounds by which the railroads will be able to meet the demands for heavier power without the adoption of a heavier rail section and a general strengthening of bridges. It is the duty of every mechanical department to prepare itself for the use of this material. Much is to be learned on both the theoretical and practical sides and the sooner both sides are mastered, the sooner will the beneficial effects be obtained.

NEW BOOKS

Proceedings of the Twenty-Fourth Annual Convention of the International Railroad Master Blacksmiths Association. Bound in cloth. 200 pages, 6 in. by 8½ in., illustrated. Published by the association, A. L. Woodworth, secretary, Lima, Ohio.

This book contains the papers and the discussions as presented at the annual meeting held at the Hotel Sherman, Chicago, August 15, 16 and 17, 1916. The range of subjects covered is unusually large. A considerable space is devoted to a discussion of carbon and high speed steels and methods of heat treatment. Other subjects treated include flue welding, spring making and repairing, drop forging, tools and formers, frogs and crossings, oxyacetylene and electric welding, casehardening, shop kinks, powdered coal as fuel for blacksmith shops, piece work and reclamation methods.

Proceedings of the International Railway General Foremen's Association. Edited by William Hall, secretary of the association. 148 pages, illustrated, 6 in. by 9 in. Bound in paper. Published by the association, William Hall, secretary, Winona, Minn.

These proceedings are a record of the 12th annual convention of the association held at the Hotel Sherman, Chicago, on August 29, 30 and 31, and September 1, 1916. The general topics discussed were the problems of the car department, counterbalancing of steam locomotives, the classification of repairs and the relation of foremen to the men. There was also a paper and discussion on fitting up frames and binders and laying out shoes and wedges. The methods of counterbalancing locomotives were discussed at length and a variety of topics were taken up under the other subjects.

Official Proceedings of the American Railway Tool Foremen's Association. 140 pages, illustrated, 6 in. by 9½ in. Bound in paper. Published by the association, R. D. Fletcher, secretary, 6324 University avenue, Chicago.

This year book is a report of the proceedings of the eighth annual convention of the association which was held at the Hotel Sherman, Chicago, August 24, 25 and 26, 1916. The papers presented dealt with the heat treatment of steel, special tools for steel car repairs, devices for reclaiming material, special tools and devices for the forge shop, and the use of grinding wheels in railroad repair shops. The information regarding tool room practice will be found useful by all tool foremen. Many special devices are illustrated and described and there is also considerable general information concerning the activities of the association.

COMMUNICATIONS

SPECIAL SHAPED NOZZLES: THE REASON FOR THEIR EFFICIENCY

St. Marys, Pa.

To THE EDITOR:

The paper presented to the Central Railway Club at its regular meeting on November 10, 1916, under the title "Fuel Economy and Proper Drafting of Locomotives,"* brought out very forcibly the advantage obtained by the rectangular nozzle over the old style circular nozzle. But a question naturally arises as to whether the improvement has reached its most efficient form.

Referring to the observations made from positions alongside of, in front of, or from the cabs of locomotives of fast-moving trains, in which the exhaust gave the appearance of filling the stack about one-third when viewed from the side, and when viewed from the front or rear seemed to fill the stack to the bulging point; these observations do not appeal to the writer as demonstrating that the round nozzle did not

soon as it is set free. This is the condition we have in the stack of a locomotive when it exhausts. We know that the circle contains the greatest area for the length of its perimeter, compared with other polygons; therefore, the jet of the circular nozzle will offer the least friction passing through the surrounding gases of the smoke box.

The rectangular nozzle has a perimeter approximately 16 per cent greater than the circular nozzle, which causes the jet to offer a greater friction to the surrounding gases, consequently carrying a greater amount of the smoke box gases with it. Its shape also creates a condition that the circular nozzle does not. By examination of the sketch we will find that the ends R_1 and R_3 of the jet will reach the inside perimeter of the stack before the center of the sides R_2 and R_4 do due to the first two sides being closer to the inside perimeter of the stack, causing a greater mingling of the smoke box gases with the jet, because the sides R_1 and R_3 begin to spread both ways when they come in contact with the stack before the other two sides R_2 and R_4 have expanded enough to come in contact with the stack. The late arrival of the sides R_2 and R_4 causes the second mingling of the gases with the jet, which has the result of further increasing the velocity of the gases.

We have the same condition with the star-shaped nozzle as we have with the rectangular exhaust, only in this case it has 47 per cent more perimeter than the circular nozzle and 27 per cent more than in the rectangular nozzle, which would increase the jet friction over the other two types, and the star shape has six points to spread and entrain the gases and six depressions to expand which, to a greater extent, would increase the mingling action of the gases in the same manner as explained for the rectangular nozzle.

It has been claimed that the rectangular nozzle has made good and shown a saving in fuel on several railroads, and it is a question in the writer's mind whether this same principle cannot be carried a step farther by the use of a star-shaped nozzle.

E. F. GIVIN.

Mechanical Engineer, Pittsburg, Shawmut & Northern.

WHAT IS AN ENGINE FAILURE?

Boston, Mass.

To THE EDITOR:

As a reader of your paper for many years I have been much interested in the several references to engine failures, mileage per failure, etc. I do not recall ever having seen a standard definition of an engine failure.

1. Is failure to make time due wholly to bad coal, an engine failure?
2. Suppose an engine is running perfectly in all respects, but that an extra sleeper or two have been added to the usual train, just enough to make it impossible for the locomotive to haul the train at the timecard speed.
3. Suppose a passenger train arrives at the terminal on time, but with an engine axle so badly heated or cut that it has to be removed.
4. Suppose, in the last case, the axle has been cooled and packed on the road, delaying the train, but causing no damage to engine.

Are all these engine failures?

The above are only a few of the items that might be worth considering in arriving at a more satisfactory definition of an engine failure.

W. J.

SUPERHEAT IN POWER PLANT WORK.—In an article in Industrial Management, Robert L. Struter states that the degree of superheat used in the United States for power plant work varies from 25 to 100 deg. F. for engines and from 100 deg. to 200 deg. F. for turbines. In Europe a superheat of 300 deg. F. is not uncommon.

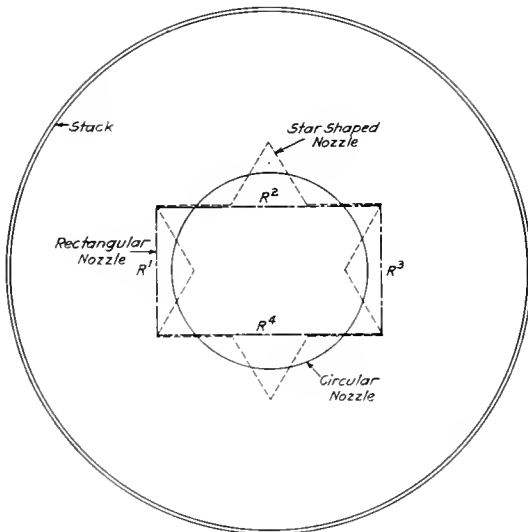

Stack with Rectangular, Star and Circular Nozzles of Equivalent Areas

fill the stack, but was rather due to the action of the wind resistance and the rapid advance of the locomotive, which would tend to bend the jet as soon as it passed the top of the stack, giving the appearance mentioned. There is no question that well-designed exhaust bases, round nozzles and stacks will cause the stacks to be properly filled, and yet will not meet the theoretical requirements as well as either the rectangular or star-shaped nozzles.

If we examine the drawing showing the cross-section of a stack with a circular, rectangular and star-shaped nozzle having approximately the same cross-sectional area, drawn one over another, we will see quite a difference in the perimeters. The following table brings this out clearly.

	Area.	Perimeter Approx
Circular nozzle, 6 in. diameter.....	28.27 sq. in.	19 in.
Rectangular nozzle, 4 in. by 7 in.....	28.00 sq. in.	22 in.
Six point star nozzle, side of point 2.33 in.....	28.00 sq. in.	28 in.

The nature of any gas under pressure is to expand and equalize with any surrounding gas of a lower pressure as

*An abstract of this paper appears on another page in this issue.

SOUTHERN DUPLEX LOCOMOTIVES

Running Gear and Machinery of Retired Engines Applied to the Tenders of Mikado Locomotives

BY the application of the running gear and machinery of retired Mogul and Consolidation locomotives to the water tanks of existing Mikado locomotives, the Southern Railway has materially increased the capacity of these locomotives without increasing the wheel load and with a marked decrease in fuel consumption per ton-mile. This has been done with but little change to either the running gear of the retired

tion. A second pipe, which permits the added use of saturated steam taken direct from the top of the boiler is also connected with this pipe. This has been added in order to provide greater steam supply to the tender engine for peak loads on heavy grades. The saturated steam supply and the superheated steam supply are controlled separately by gate valves in each pipe, operated from the cab. The steam

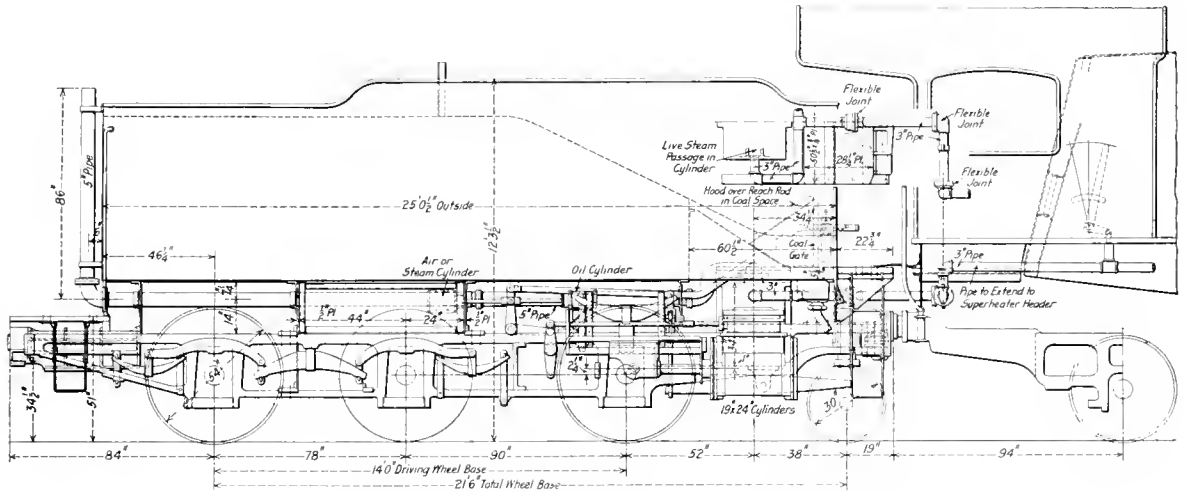

General Arrangement of Mogul Running Gear and Machinery Applied to a Mikado Tender

engines or to the water tanks of the Mikados. In fact, it is as though the boiler were lifted from the retired locomotive and the water tank of the Mikados placed on the frame in lieu thereof, the running gear and machinery, together with the cylinder castings and frame remaining intact. The diameter of the cylinders of the tender engine has been reduced, which, with the reduction of one inch in diameter of the Mikado type cylinders, does not overtax the Mikado

supply to the Mikado engine itself is also independent of these two sources. The reversing mechanism for the tender engine is controlled from the engine deck, as indicated in the drawings. The reach rod is provided with notches to give full gear, three-quarter gear, one-half gear and one-quarter gear forward, and full gear and three-quarter gear backward. The reversing gear of the tender engine may be operated by any suitable reversing mechanism and, where operated by

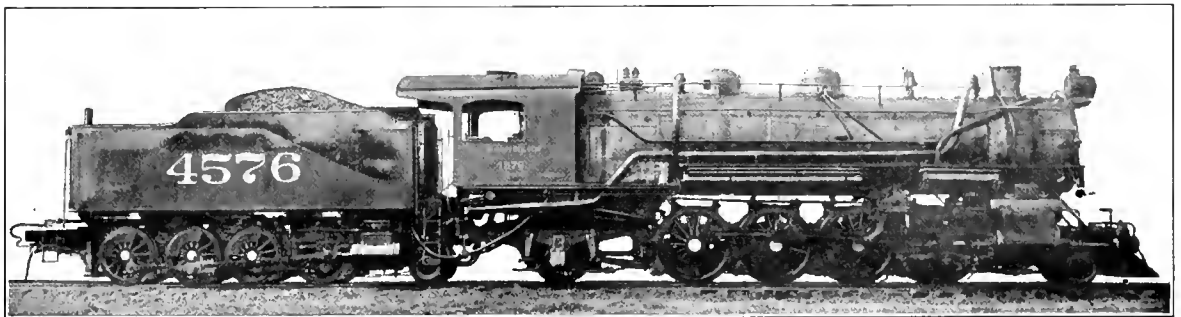

Southern Railway Duplex Locomotive with Consolidation Running Gear under the Mikado Tender

boiler to any great extent. In addition to the reduction in cylinder diameter, the boiler capacity has been increased by the addition of brick arches and a feed water heater which uses the exhaust steam from the air compressor.

Steam for the tender engine is taken directly from the superheater header through a well lagged 3-in. pipe extending backward underneath the cab, as shown in the illustra-

tion. In either case the details are substantially the same. hand, an air cylinder with an oil cylinder dash pot is used to assist in the movement of the gear. The photograph shows the application of the running gear and machinery of a Consolidation locomotive to the tender, while the drawings show the application of the Mogul type engine to the tender.

With the application of the Consolidation running gear to

the tender the draw-bar pull of the Duplex Locomotives is 39 per cent greater than that of the original Mikados. The locomotive is operated at 175 lb. boiler pressure, which, with 27-in. by 30-in. cylinders and 63-in. drivers in the original Mikados, gives a tractive effort of 51,600 lb. By reducing the diameter of the cylinder to 26 in. the tractive effort of

over the first 22 miles of this line is 1,100 tons. The Duplex locomotives will handle 1,400 tons, or an increase of 27 per cent. On this part of the line there is a 1.5 per cent grade for 5 miles, with many reverse curves.

For the remaining distance, 40 miles, there is one short grade of 1.7 per cent with reverse curves and a slow approach

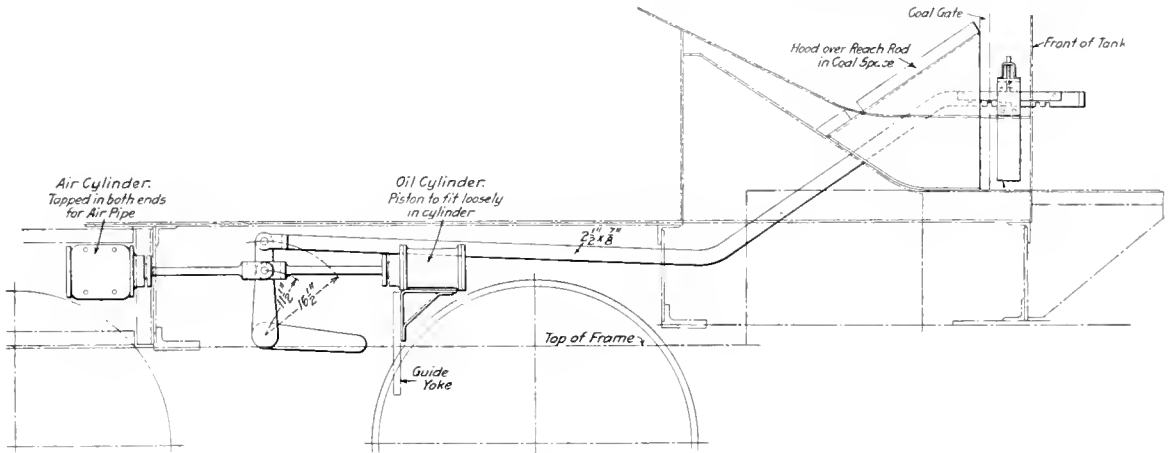

Arrangement of the Reversing Gear for the Tender Engine

the Mikado locomotive was reduced to 47,900 lb. The tractive effort of the tender unit in case of the Consolidation locomotive, with 20-in. by 24-in. cylinders, and 50-in. driving wheels is 28,600 lb., making a total of 76,500 lb. Tests have shown that the draw-bar pull available from the combination is 64,000 lb., as compared with 46,000 lb. for the single Mikado, or an increase of 39 per cent. It has been

which, with other grades of the same percentage but with less curvature, limits the capacity of the single Mikados to 1,150 tons. The Duplex locomotives will handle 1,600 tons, or an increase of 39 per cent. The average for the whole eastbound trip is 77,100 ton-miles for the single Mikado locomotives and 104,400 ton-miles for the Duplex locomotives, or an increase of 36 per cent. In handling this

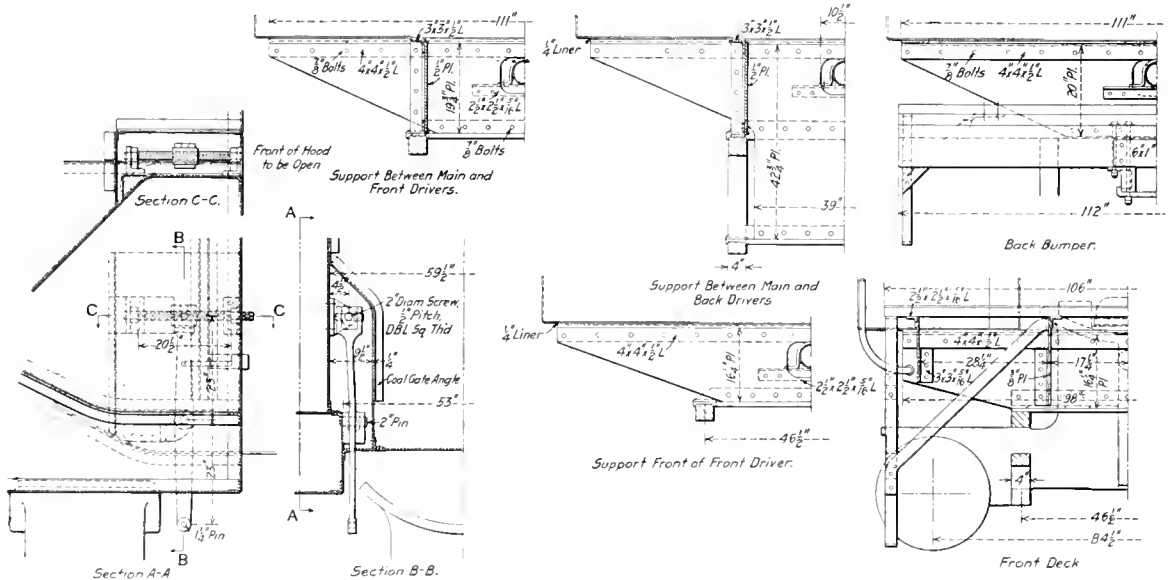

Details of the Tank Supports on the Mogul Type Tender Engine

found that the maximum draw-bar pull of the Duplex locomotives can be sustained on a continuous pull for 50 min. Several of these locomotives have been installed on the line between Asheville, N. C., and Hayne, S. C., a distance of 68 miles. On this line, eastbound, the heavy traffic direction, there are 1.5 per cent and 1.7 per cent grades. With the single Mikado locomotives the maximum tonnage handled

additional tonnage the Duplex locomotives burn substantially the same total amount of coal as the single Mikados, the average for the Mikados being 18 lb. per 100 ton-miles, and for the Duplex locomotives 12 lb. per 100 ton-miles. The engine crews on this line make a round trip of 136 miles in an average running time of from 12 to 13 hours.

The Mogul tender units have 19-in. by 24-in. cylinders

with 54-in. drivers, which with 175-lb. boiler pressure, gives a tractive effort of 23,850 lb. This, added to the 47,900-lb. tractive effort of the improved Mikado locomotives, gives a total tractive effort of 71,750 lb. In only the Mogul application is the factor of adhesion with the minimum weight of

solidation wheel arrangement is 176,000 lb. maximum and with the Mogul wheel arrangement, 152,000 lb. maximum.

The drawings show the application of the running gear and machinery of a Mogul type locomotive to the water tank of the Mikado type locomotive. The entire lower part of the Mogul locomotive remains practically unchanged. The cylinder casting is retained intact and the front and rear draft castings are changed slightly, the front draft casting being shown in one of the illustrations. The upper rails of the frames are 4 in. by 4 in. and the lower rails are 4 in. by 2 1/2 in. The water tank is supported on the frames by five 1/2-in. transverse plate supports riveted to 4-in. by 4-in. by 1/2-in. angles on the water tank and to frame cross braces at the frames, and by a 1/2-in. plate support about 5 ft. long on each side of the tank over the main drivers. The fourth transverse plate support extends down to the lower rail of the frame. The 3-in. steam pipe running to the tender engine contains three ball joint connections between the engine and tender to give the necessary flexibility. The exhaust from the cylinders passes through a 5-in. pipe to the rear of the tank. This pipe is clamped at each of the transverse supports by a strap riveted to a 2 1/2-in. by 2 1/2-in. by 5/16-in. angle riveted to these plates.

A pocket is formed in the tank at the front end to provide proper clearance for the rear cylinders, it being redesigned, as shown in the drawings. The Mikado type boiler has a total heating surface of 3,231 sq. ft., with a grate area of 54 sq. ft. The weight on the front engine drivers is 215,700 lbs., with a total engine weight of 272,940 lb. The tank has a capacity of 8,000 gal. of water.

POWDERED COAL FOR BLACKSMITH SHOPS*

BY C. F. HERINGTON

Mechanical Engineer, Powdered Coal Department, Cannon Company, Canton, Ohio

In spite of the constant demand for increased efficiency in manufacturing, the question of industrial heating, important as it is, is too often lightly considered or overlooked by the management. The B. t. u.s you can buy for a cent does not determine the quantity or the quality of the product you get for a dollar. If the furnaces are so designed as to utilize powdered coal to the best advantage, and the coal dust is economically conveyed and regulated at the furnace to leave no residue of fine particles of coal dust on the work, and the smoke and ash are carried away, a fuel will be had which fulfills everything to be desired.

If the choice of fuels was made on the basis of the heat units they contain coal would surely be chosen, for if fuel oil costs five cents a gallon, coal would have to be \$10 a ton to make the cost equal for the same number of B. t. u.s. But this does not by any means measure the comparative efficiency of heating furnaces, for the real problem is one of heating cost and heating efficiency, and not fuel cost. Fuel must be selected which, all things considered, will show the lowest production cost in the shop under prevailing conditions.

Comparing powdered coal with fuel oil and gas on a basis of the heat content, it is found that one gallon of oil costing five cents contains 140,000 B. t. u.s, which is equal to 10 lb. of coal of 14,000 B. t. u.s per pound. Assuming that coal costs \$2.50 per ton, and the cost of grinding and distributing it to the furnaces is 50 cents, fuel oil would have to sell at 1 1/2 cents per gallon to make the cost of oil and coal the same per B. t. u. On the same basis natural gas must be bought at 11 1/4 cents per 1,000 cu. ft., and producer gas at two cents to equal powdered coal at \$3 per ton.

In the eastern part of Pennsylvania there has been in operation for a year and a half a powdered coal plant operated on what is known as the Holbeck system. In this system air is

*From a paper presented at the annual convention of the International Railroad Master Blacksmiths' Association.

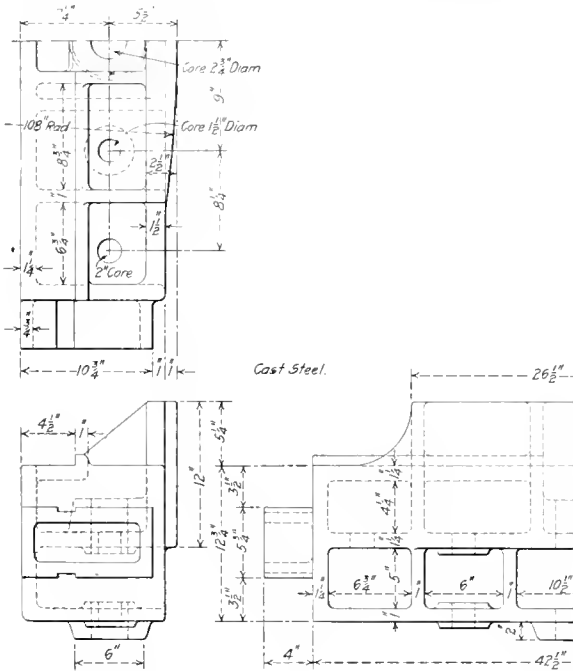

Front Draw Casting of the Tender Unit of the Duplex Locomotive

tender much too low. In this case, with the tender practically empty of water and coal, a factor of adhesion of only about 2.25 is obtained, while in both cases the maximum factor of adhesion, that is, with the tender loaded, is 5.25.

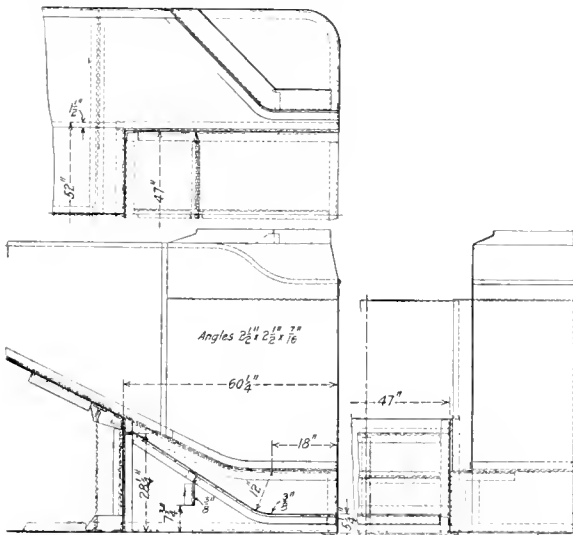

Front End of the Tank as Redesigned for the Duplex Locomotive

In case of the Consolidation tender unit the minimum factor of adhesion is about 3.25, and inasmuch as this unit is used more than the Mogul unit, but little difficulty is experienced in this regard. The weight of the tender unit with the Con-

used as an agent for conveying the coal dust to the different furnaces. The coal is first pulverized in the usual manner and delivered to a storage bin located in the coal building. This bin is the only one in the plant used for storing pulverized coal, and was made of sufficient capacity to serve the furnaces for one day. The powdered coal is taken from this bin by a double flight screw conveyor driven by a variable speed motor. It is then sent into the suction of a high pressure blower, which blows it into the distributing main which carries it to the furnaces through branch lines. The coal which is not used at the furnaces is returned through a return line to a collector located on top of the powdered coal bin. It is extracted from the air and falls into the storage bin where it is used over again. The air from the return line, after the coal is extracted, is returned to the suction side of the distributing blower. Interposed in the distributing main and the distributing blower is a specially designed air indicator and regulator which is used to indicate the flow of air through the system, and to control the feed of powdered coal into the system so as to supply a uniform mixture of coal dust and air to the furnace, regardless of the number of furnaces that are in operation.

With the Holbeck system powdered coal can be conveyed any distance from the coal or grinding plant. The installation mentioned is in a blacksmith shop, and the powdered coal is carried in suspension through pipes and back to the collector, a distance of 2,125 ft. The air and coal dust is carried through spiral riveted pipes, and whenever the velocity is reduced by friction a second, third, or even fourth booster blower is added so that the circulation can be kept for an indefinite distance. No wear is discernible in this piping system.

The advantages of the system are, first, the actual consumption of power for furnishing the coal dust to the furnaces is very low; second, the wear and high cost of repairs incidental to the old method of using screw conveyors is eliminated; third, the storage bin at each individual furnace, which takes up valuable space, is done away with; fourth, within a few minutes after the furnaces are shut off the coal dust is all returned to the storage bin in the pulverizing plant, thus leaving no coal dust in the shops or at the furnaces. In installing this system no large combustion chamber is built, nor are the furnaces changed to any extent. The oil or gas supply is simply cut off and one or two branches of pipe brought down to the furnace with a valve near the main, so arranged that it can be operated from the floor.

SERVICE TESTS OF STEEL SPRINGS

BY GEORGE T. GLOVER
Locomotive Engineer, Great Northern Railway of Ireland

Spring trouble is one which besets many railways on this side of the Atlantic, and there appears to be little record of practical experience in the technical press in regard to methods to overcome the trouble. The Great Northern Railway of Ireland possesses some shunting tank locomotives, shown in Fig. 1 and designed in 1908, which, although of comparative light load per axle, give an undue amount of trouble with spring breakage. The springs shown in Fig. 2 are those under the coupled wheels of 4 ft. 3 in. diameter on tread, and are of a normal British design. They are hung, as shown in Fig. 3, from non-adjustable spring links.

These locomotives have to work on some very indifferent permanent way around the Belfast docks and shipyards, part of the line being laid through public streets in stone sets similar to a tram line, and no system of maintaining the joints at the ends of the rails has been found to give satisfactory results under such heavy traffic, nor will the urban authorities proceed to much expense in maintenance.

No alteration could be made in the design of the locomotives or of the permanent way. Seeing the apparent results

of vanadium in certain American motor cars and noticing the constant reference to vanadium steel in the specifications of new locomotives as described in the *Railway Mechanical Engineer*, we determined to give vanadium steel a trial in these springs.

The matter was referred to the Vanadium Company, whose agents supplied springs of the railway company's pattern, but made of vanadium steel of the tensile test and analysis, shown in Table I.

TABLE I

	Ult. stress, tons per sq. in.	Yield point, tons per sq. in.	Elong. in 2 in., per cent	Redn. area, per cent
Normalized	56.8	37.4	17.0	35.0
Tempered (as in spring)	102	96.5	9.0	25.0

123 = 578 Brinnell
Too hard to grip in test jaws.

Analysis

C.	P.	S.	Si.	Mn.	Chr.	Van.
.5	.028	.033	.17	.45	.96	.21

The most interesting point to be noted is the high percentage of yield point to ultimate tensile stress, particularly

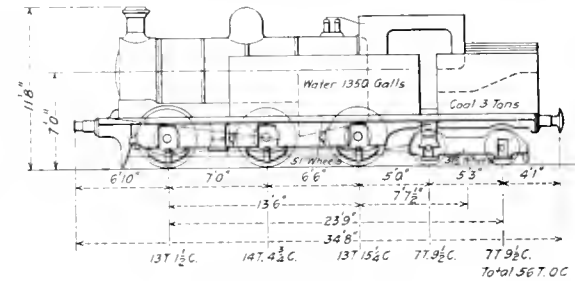

Fig. 1—Type of Locomotive That Was Used in Making Spring Tests

in the tempered state. No details are available as to the tempering, etc., as this was carried out at the maker's works, the springs being supplied complete to drawing and ready for putting under the engines. The springs stood the following loading test, the chief point of interest here being the small range per ton weight and the high elastic limit of the spring, permitting a return to the initial loaded camber after a reversal of camber to 5/8 in. beyond straight:

Tons.....	0	2	4	6	7 1/2	10	12
Deflection...	1 in.	11/16 in.	7/16 in.	3/16 in.	Str.	-5/16 in.	-3/8 in.

The engine springs that were replaced by vanadium steel were made of a good grade of English spring steel; a test

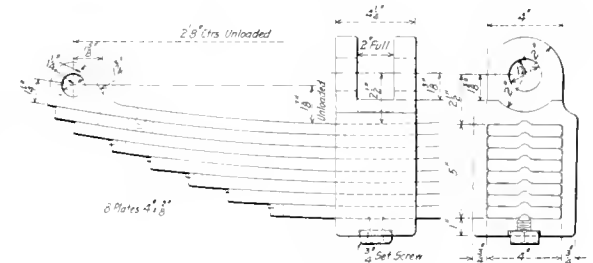

Fig. 2—Type of Spring Under Test

from the normal engine spring made of this steel gave approximately the tensile test and analysis, shown in Table II.

TABLE II

	Ult. stress, tons per sq. in.	Yield point, tons per sq. in.	Elong. in 2 in., per cent	Redn. area, per cent
Normalized	45.2	33.2	19.0	37.0
Tempered	72.6	38.4	2.0	7.0

Analysis

C.	P.	S.	Si.	Mn.
.54	.028	.028	.13	.72

This steel is giving perfect satisfaction in the main line locomotives of the company under heavier axle loads than in the tank locomotives, except in certain cases where these locomotives have to run on a portion of the inferior permanent way mentioned.

There is no reason for adopting the vanadium steel springs all round, as the work of the main line locomotives is confined to the excellent modern permanent way of the company and does not entail movement over the dock lines where spring trouble is chiefly experienced. In addition, adjustable spring gear can be used under the larger wheel of the main line locomotives, as shown in Fig. 4. This gear can not be used on shunting locomotives, due to lack of clearance.

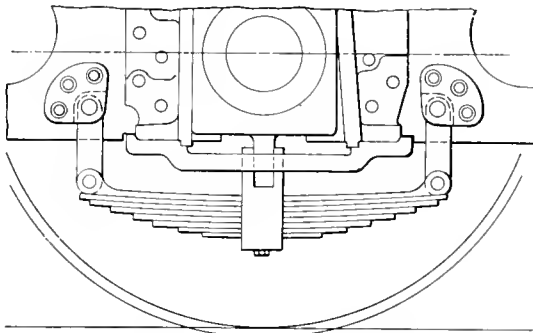

Fig. 3—Test Spring With Non-Adjustable Spring Link

The results to date of the adoption of these springs have been satisfactory in every way and are shown in Table III.

TABLE III—SPRINGS BROKEN

Engine No.	1914 Carbon steel	1915 Vanadium steel
22.....	37	4
23.....	44	4
38.....	25	1
99.....	26	1
108.....	29	0
112.....	23	3
160.....	42	2
163.....	13	1
166.....	29	2
*167.....	29	6
	291	24

*In this case broken vanadium steel springs were replaced with ordinary steel springs which failed to stand up with the vanadium springs.

In the case of carbon steel springs the repairs to damaged springs were carried out at the company's works, where the

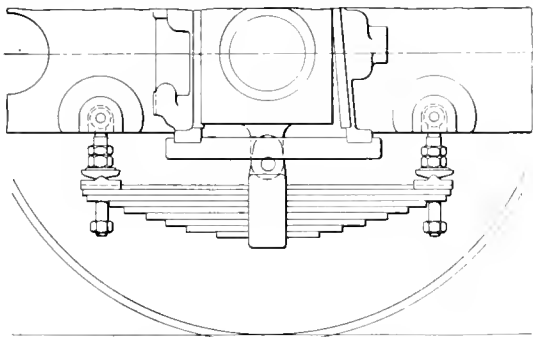

Fig. 4—Adjustable Spring Link Used On Main Line Locomotives

skill and appliances are not equal to the maker's, so that the proportion of about 12 to 1 should be reduced to about 6 to 1, even then the economy is remarkable.

As a test six new carbon springs were put in as from makers in an engine where vanadium had lasted 12 weeks, the new carbon spring failed in 2 weeks, whereas the repaired

carbon only lasted one week. In the case of the breakage of ordinary steel springs, as a rule, it involved replacing half the number of plates, whereas in the case of the vanadium steel springs only one or two plates, usually top plates, require replacement.

The vanadium steel springs were supplied at an additional cost of roughly 50 per cent, or £9 for the set of 6 springs—no calculation is required to show how rapidly this is recouped when the changing or repair of defective springs, lifting of locomotive, loss of service of locomotive, etc., is taken into consideration. These prices refer to normal years, such as the early part of 1914.

The only slight drawback at present experienced is in the repair of vanadium steel springs, as our shop outfit at the Dundalk locomotive works does not include the pyrometers or furnaces necessary for the exact heat treatment of this steel, and the ordinary methods suitable for carbon steel are not sufficiently accurate; it is, therefore, at present necessary to have repairs and retempering carried out by the spring makers, involving delay and expense in transit.

No difficulties in the repair of these springs should be experienced in the shops of the larger railway companies, where pyrometers, special heating baths, etc., are in sufficient daily requirement to warrant their installation.

LOAD DISTRIBUTION AROUND THE DRY PIPE OPENING OF FRONT TUBE SHEETS

BY THOMAS H. WALKER

There is one flat surface in a locomotive boiler, the load distribution in which is not discussed even in books on locomotive boiler construction. That is of the area about the dry pipe opening in the front tube sheet. The writer has often sought information on this point from others, but without satisfaction. A number of rules-of-thumb have been found in use in various places, but no precise reason for any of these rules could be given. After some consideration the problem was worked out as follows, assuming that the ring around

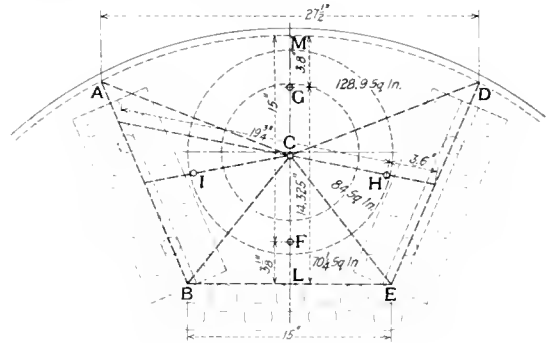

Analysis of Loads Around the Dry Pipe Opening

the dry pipe hole is heavy enough to transmit the loads involved, which ordinarily will be true.

In the drawing, *A M B* is the inner face of the tube sheet flange, *A B* and *D E* are the center lines of steel T's riveted to the sheet on either side of the dry pipe opening and approximately radial to the flange. The line *B L E* is drawn through the top of the upper row of tubes.

These lines are assumed as the points of support because it is common so to regard them. The writer does not entirely agree with the correctness of this view, but inasmuch as the distribution of the load is not materially affected, it is thought better not to complicate the problem by a discussion of the points of support.

Find the center of gravity of the surface included by *A M D E L B*. With this located at *C*, draw lines from *C*

to *A, D, B* and to *E*, thus dividing the area into three triangles and a combined triangle and a segment of a circle.

Assume a pressure of 200 lb. per sq. in. over this surface. Then on the triangle *C B E* the load will equal its area, 70½ sq. in., times 200, or 14,050 lb. If we consider the load as concentrated at *F*, the center of gravity of this triangle, with an adequate support at *C*, it would be distributed inversely as the length of the lever arms *F C* and *F L* on *B L E*. As the center of gravity of a triangle is one-third its height from the base we have an easy method of distributing the load carried. We have, however, no support at *C* but must go 8¾ in. over to *M* to get a support in this direction. The lever arm *F M* is 15 in., while from *F* to *B L E* remains 3¾ in. Of the total load at *F*, 15/18.125 is on *B L E* and 3.125, 18.125 is transferred to the flange about *M*, or 11,627.5 lb. is at *L* and 2,422.5 lb. is at *M*. Considering the triangle *C D E* in a similar way, calling the center of gravity *H*, the lever arms from *H* are respectively 3.6 in. and 19.75 in. long. The area of this triangle is 84 sq. in. and its load of 16,800 lb. is so divided that 14,210 lb. falls on *E D* and 2,590 lb. falls on *A B*. The load on the triangle *A B C* is exactly equal to that on *C D E* and the distribution of the load exactly opposite; that is, 14,210 lb. is carried to *A B* and 2,590 lb. to *E D*.

The area enclosed by *A M D C* must now be considered. Its area is 128.9 sq. in. and its center of gravity *G* is 3.8 in. from *M* and 18½ in. from *L*. Of its load of 25,780 lb., 21,313 lb., therefore, rests on the flange and 4,467 lb. rests on the tubes.

The loads carried by the various lines of support are summed up in tabular form. The statement shows that of

Load Distributing Around Dry Pipe Opening.			
A M D	A B	D E	B E
21,313 lb.	2,590 lb.	14,210 lb.	4,467 lb.
2,422.5 lb.	14,210 lb.	2,590 lb.	11,627.5 lb.
23,735.5 lb.	16,800 lb.	16,800 lb.	16,095.5 lb.

the total load, about 32 per cent is on the flange, 23 per cent on either side of the T's and 22 per cent on the tubes. If the tubes are further away than in the case considered the resulting proportion is substantially the same so long as the T's are the same distance apart at the dry pipe center. A case in which the upper edges of the tubes were 4½ in. from the ring around the dry pipe opening instead of 2½ in., as shown, gave 32½ per cent of the load on the flange, 23½ per cent on each T and 20½ per cent on the tubes.

When the throttle valve is open the steam inside of the dry pipe, being practically under the same pressure as that in the boiler, will balance the load on the area of the dry pipe opening; but when the throttle is closed this is not true and it is manifestly not proper to deduct anything on this account.

The dry pipe, however, being strongly fastened to the tube sheet and anchored at its inner end to the dome and shell, does act as a substantial brace to this portion of the tube sheet, holding it at a right angle to the boiler shell against the deflection which the otherwise unsupported plate would have under the pressure, thus, in effect, transmitting a part of the load which otherwise would fall on the T's or the tubes, up to the flange.

In arriving at the total load on each T, that due to one-half of the area of the next space outside each T must be added to the 23 per cent of the load around the dry pipe opening.

It is of some interest to note that the load carried by the flange above the dry pipe opening is equivalent to that on a surface extending 4½ in. or more from the inside face of the flange.

Some of our lawmakers have decided that 3 in. from the outside of the flange inward is all that any flange can carry. It is difficult to see what we or they can do about a tube sheet flange that will carry more than the law allows. For years it seems to have gone about its business in its own way, regardless of law or lawmakers. It is true that tube sheet

flanges crack sometimes—somewhere else. So we suppose we will continue to increase the size of the brace rods,—somewhere else—to compensate for the places where we cannot put them and where no sane and sensible person should want to put them.

MIDWESTERN MECHANICAL VALUATION COMMITTEE

A meeting of mechanical valuation department officers of railroads of the middle West, for the purpose of forming a committee on mechanical valuation was held in Chicago on February 14. C. T. Ripley of the Santa Fe has been made chairman of the committee and W. H. Davis of the Burlington, secretary.

Under the present circumstances there is little uniformity of practice in mechanical valuation in the central and western districts. As each company takes up the work of mechanical valuation, it is necessary for them to do research work alone and to originate methods of organization, handling of field and office work and cost data. Each road has been obliged to take up each problem of the work and deal with it as an individual, although the same question may have been disposed of effectively by some other company in handling its work.

The companies which have finished their work are in an excellent position to assist those which have the mechanical valuation work before them. Some effort has been made to interchange information, but lack of organization has made it difficult. The purpose of the committee will be to discuss the various questions arising and extend the standardization of methods as far as possible. Sub-committees have been appointed to deal with the valuation of locomotives, cars and shops, and to discuss methods of complying with order No. 8.

Some of the subjects discussed at the first meeting were the methods of determining depreciation of locomotives, cars and machinery, scrap values, weighted averages of parts for cars and locomotives, methods of complying with order No. 3, hidden costs in additions and betterments, material in working stocks, methods of making small tool inventory, methods of inventorying work equipment, costs of installation, costs of installing pipe lines, costs of electrical installations, costs of patterns and blue prints, and costs of foundations. The various subjects discussed were assigned to the sub-committees for study.

TRACTIVE EFFORT FORMULA.—The last two equations in Mr. Fry's article, discussing the Kiesel Locomotive Tractive Effort Formula in the February *Railway Mechanical Engineer* on page 70, were incorrectly given. They should have been:

$$T_v = \frac{2.24}{1 + 0.0092 BV} \text{ for saturated steam} \dots\dots\dots (1 C)$$

$$T_v = \frac{2.24}{1 + 0.0077 BV} \text{ for superheated steam} \dots\dots\dots (1 D)$$

CARS AND LOCOMOTIVES ORDERED IN FEBRUARY.—The purchases of equipment in February were characterized by large and continued purchases of locomotives. January and February have been exceptionally good months from the standpoint of locomotive buying, the orders thus far reported this year having totaled 1,146, of which 780 are for domestic use and 366 for export. The totals for the month were as follows:

	Locomotives	Freight Cars	Passenger Cars
Domestic	623	12,031	199
Foreign	98	9,100	...
Totals	721	21,131	199

The largest purchaser of freight cars during February was the French Government. Several American companies authorized the construction of large numbers of cars in their own shops.

A STUDY OF BOILER FEED WATER

The Boiler Itself a Laboratory Where Chemical Reactions Take Place in Feed Water Impurities

BY GEORGE L. FOWLER

IN a recent study of boiler feed waters on a railroad afflicted with a variety of troubles, certain facts and conditions were brought to light that were new to those conducting the investigation, and they may prove of interest to others who find themselves in the same situation.

In dealing with this investigation, the general principles involved will alone be discussed, as a discussion of the remedies applied would be misleading. This will readily be understood as the development of the subject proceeds. Furthermore the several varieties of water and the methods of handling them will be described separately, as if they were different problems and had been worked out independently, although the investigations were carried on simultaneously, and the data secured at one point often threw light on the situation and suggested the treatment at another point.

The one broad and surprising development all along the line was the impossibility of placing full dependence, and sometimes of placing any dependence whatever, on the analyses of the raw water as drawn from the wayside tanks.

The waters encountered were scaling, corrosive, foaming and muddy, with a tendency to corrode in every case except the foaming.

In one case, where a well water had been used, and a treating plant established, so much trouble had been experienced from foaming that the treating plant had been closed and the water abandoned. This was due to the amount of soda that it had been necessary to add in order to free the water from the sulphate scales. The raw water carried so much of the sulphates of lime and magnesia that the soda added to precipitate them raised the alkalinity to a point where the water was too light for use.

With the abandonment of this well, recourse was had to a somewhat muddy river the water from which was used over an entire division. Its analysis showed little variation, from point to point, the average being about as follows:

	Grains per gallon.
Calcium carbonate	2.42
Calcium sulphate	1.53
Magnesium carbonate	.74
Magnesium sulphate	.88
Sodium sulphate	.15
Sodium nitrate	.07
Sodium chloride	2.29
Silica	.66
Alumina and iron oxides	.15
Organic matter	.36
Volatile matter	.44
Total	9.69

From an inspection of the analysis this water would not be considered bad except for the scale-forming ingredients, which were not excessive, and the organic matter, which might decompose and form an acid reaction. It did not cause much trouble from scale. The sheets could be kept comparatively clean, except for clusters of scale that formed to a considerable thickness about the crown sheet staybolts. The extent of these formations is indicated in the sketch.

The scale formed in this district was of medium hardness and brittleness and was easily removed from the surfaces to which it adhered by tapping it with a hammer. It would then peel off in large flakes leaving the metal clean. Where the sheets were bare or the scale thin there was no corrosion. But where the scale formed corrosion took place beneath it, forming a large pit as shown. The thicker the scale, the deeper was the pit.

Pitting of the tubes was not as bad at the front end of the

boiler as at the rear, the worst condition being found about six feet ahead of the back tubesheet on tubes 19 ft. long. The corrosion was also worse on the top than on the underside of the tubes.

A similar but more pronounced corrosion occurred on the crown sheet at the staybolts. Here, too, it was more pronounced under the thickest scale. The scale formed around the staybolts eccentric with them towards the side of the fire-box and almost truly concentric at the center. The slow movement of the water from the side in towards the center apparently was checked by the staybolt and the greater part of the scale deposited here. Occasionally the scale would form on a line from one bolt to the next and then the corrosion would extend between the bolts thus connected, forming a wide groove from bolt to bolt.

As water appeared harmless and the corrosion occurred only beneath the scale it was surmised that the scale might be corrosive. A sample of the scale was therefore analyzed with this result:

	Per cent.
Calcium sulphate (Ca SO ₄)	83.60
Calcium carbonate (Ca CO ₃)	3.96
Magnesium hydroxide [Mg (OH) ₂]	2.88
Silica (Si O ₂)	4.09
Alumina and iron oxide (Al ₂ Fe ₂ O ₃)	2.99
Combined water and organic matter	1.64
Water driven off at 163° C.	1.09
	99.67

As there was nothing in this scale of itself of a corrosive nature, it would seem that after the deposition of a certain amount of scale the plates beneath it become locally overheated. This causes a decomposition of the organic matter, the calcium sulphate and the magnesium hydroxide forming

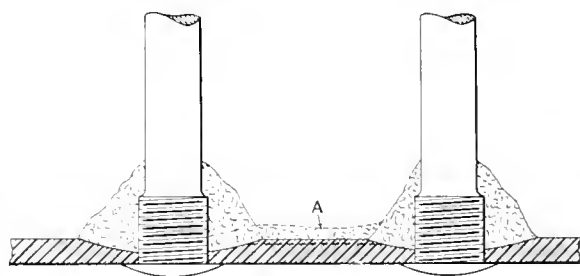

Scale Formation and Pitting Around Crown Sheet Staybolts

free sulphuric acid which is partially protected from dilution with the boiler water and attacks the sheets.

The cure, then, lies in preventing an accumulation and adhesion of scale. A remedy was applied for this purpose. The scale already formed was broken up, the adhesion of new deposits prevented and, up to the present time, this seems to have stopped the corrosion.

In another case there was little or no trouble from scale, but there was an intense and rapid corrosion that would destroy tubes by pitting in 9 or 10 months.

The water that was doing this did not even give an acid reaction, and though the analysis corresponded to that which was known to have a corrosive action, there was nothing to account for the intensity of the action which actually took place.

A difficulty in making a correct diagnosis of the case lay

in the known probable wide variation in the character of the water drawn from the same tank. Throughout this whole region the water was drawn from small mountain streams that received the drainage from mines and the sewage from villages, and which a sudden shower would raise to overflowing banks.

At one place where there was about 33 grains of scale forming matter to the gallon, of which nearly 30 grains were lime and magnesium sulphates, a lime and soda treating plant had been erected; the results, however, were unsatisfactory. The scale-forming content had been cut down but the soda had raised the alkalinity of the water to the foaming point and engineers had learned to avoid it if possible.

After a rather thorough examination of old analyses of the waters of the region, it was decided that something was happening in the boilers of which nothing was known. Two boilers were selected, the water of each of which had been taken from a single tank, and samples analyzed after having been in service for about eight days. The variation in the composition was startling, as shown by the following analysis:

Impurities	Grains per gallon	
	From tank	From boiler
Calcium carbonate	.29	...
Calcium sulphate	15.05	7.02
Magnesium sulphate	11.67	28.81
Magnesium sulphate (manganic)	...	10.61
Iron sulphate (ferric)	...	43.87
Alumina	...	45.15
Sodium sulphate	9.62	38.38
Sodium chloride	1.52	14.99
Sodium nitrate12
Silica	1.51	21.93
Alumina and iron oxide	.52	...
Organic matter	1.96	17.21
Free sulphuric acid	...	2.33
Total	42.16	230.42

The water taken from the boiler was extremely bad. The free sulphuric acid, coupled to the large quantity of organic matter, fully explain the rapid corrosion that takes place in the boiler using the raw water from which it is formed. Tubes were fitted and seams cut away in a short time so that the working of the engines became an impossibility.

Because of the uncertainty as to the uniformity of the quality of the water delivered to the boiler, an experimental investigation was instituted. A small boiler of about two gallons capacity was built, in which definite samples of water were evaporated. As first built the boiler was fitted with a gravity feed in which the water was heated before it entered the boiler, and where there was evidently some deposit of scale. The boiler was operated under a steam pressure of 200 lb. per sq. in.

The method of operation was to draw a quantity of water from the tank to be examined, and analyze it; then to take 75 gallons of the sample and evaporate it to one gallon in the small boiler. A typical result is given in the following analyses:

Impurities	Grains per gallon	
	Raw water from tank	Concentrated water from boiler
Calcium carbonate	1.34	.73
Calcium sulphate	...	1.91
Magnesium carbonate	.70	...
Magnesium sulphate	.17	2.76
Magnesium chloride	...	1.74
Sodium sulphate	.52	...
Sodium chloride	.70	2.11
Sodium nitrate	.07	.57
Silica	.58	5.47
Alumina and iron oxide	.29	2.64
Organic matter	.81	2.29
Total	5.18	20.24

These analyses present a good example of the change which has been found repeatedly to take place in water that has been subjected to the high pressure and temperature obtaining in a locomotive boiler.

It will be seen that while some compounds disappear others

are formed. In this case the raw water contained neither calcium sulphate nor magnesium chloride and yet both were found in the water taken from the boiler. On the other hand, the sodium sulphate and magnesium carbonate disappeared. The calcium sulphate was probably formed by the decomposition of the sodium sulphate and the passage of the sulphuric acid over to the lime, while the magnesium chloride was probably formed by the decomposition of the salt in the presence of the organic matter and the taking up of the chlorine by the magnesium. The further decomposition of the magnesium chloride formed hydrochloric acid which directly attacked the sheets.

The statement as to the decomposition of common salt (sodium chloride) is thought to be novel and may be incredulously received. Salt has always been considered one of the most stable compounds that would remain unchanged, through all the vicissitudes of repeated dissolving and precipitation by evaporating. In seven cases where these evaporation tests were made, however, each showed an apparent disappearance of the salt and the formation of new compounds that did not exist in the raw water.

Though the evidence is not absolutely conclusive, this phenomenon seemed so well assured that it was considered worth while to attempt to regulate it. One of the worst of the waters was selected and subjected to the boiling test and an examination made, so that the reactions were known. The raw water was then treated with sufficient barium hydroxide to precipitate all of the sulphates as barium sulphate, at the same time in the hope of removing or decomposing the organic matter that appeared to be giving so much trouble. Again a concentration test was made of 75 gallons of the water thus treated, with the following results:

Impurities	Grains per gallon	
	Treated raw water	Concentrated water
Calcium carbonate	1.11	.70
Magnesium carbonate	.11	.05
Sodium carbonate	2.45	69.18
Sodium sulphate	.58	57.87
Sodium chloride	.76	9.91
Sodium silicate	...	2.63
Silica	.53	...
Alumina and iron oxide	.06	.53
Loss on ignition	.40	4.14
Total	6.00	145.01

These results show that while the elimination of the sulphates was practically accomplished the organic matter was not thoroughly removed, and that all of the sodium was retained in solution and combined with the liberated carbonic acid, some of the sulphuric acid and the silicic acid present, thus making the water strongly foaming. Had less barium hydroxide been used more sulphuric acid would have remained; had more been used free sodium hydroxide would have been found in the concentrated water. The results of this test, therefore, were disappointing.

To effect a complete removal of the organic matter a third trial was made in which 15.5 grains of alumina in the form of aluminum cream was added. The desired end was not attained and the failure was even accentuated by the tendency to foam that developed towards the end of the test.

As these waters do not lend themselves to successful tank treatment two methods were adopted to prevent the corrosive action, both of which appear to be working successfully. One is to make an examination of the water in the boiler each day, and prescribe the amount of soda compound that is to be used. The examination requires only five to ten minutes' time and the application is made through a hose attached to the suction chamber of the injector. Enough of the compound is used to maintain the alkalinity of the water in the boiler at .3 per cent, which, while not entirely non-corrosive, is so nearly so as to avoid trouble.

The other and simpler method is to apply a corrosion inhibitive at each washout. If the boiler has been in service

for some time and the corrosion has started it has been found to require three or four applications to stop it. After that the water drawn from the boiler will be clear and free from oxides. Where this treatment is used and the water in addition to its corrosive qualities carries scale-forming matter in any quantity, it is necessary to add a scale preventative to the inhibitive.

In still another case, where the water was drawn from a territory in the immediate vicinity of iron pyrites mines, and the boiler formed a chemical laboratory that made and unmade variety of compounds, one of the regular proprietary boiler compounds was found to possess the qualities needed to cut scale and prevent corrosion, the water flowing from the boiler clear, instead of almost blood red and filled with iron oxides, as when used without treatment.

Finally, owing to the possible error that might have crept into some of the determinations because of the pre-heating of the water before delivery to the boiler, the latter was overhauled. The heater with the gravity feed was removed and a pump substituted so that cold water was delivered to the boiler, within which it received all its heat. A condenser was also added so that all escaping steam could be collected and made available for analysis.

The water selected for the trial was one that had a bad reputation for scaling and corrosion. It was recognized as unfit for boiler purposes in any event and was made worse by being raised with an air lift, thus becoming charged with air and carbonic acid.

Evaporative tests of this water were made and they will be given in some detail to emphasize the reactions that take place in a boiler when working under the pressure and temperature involved in modern conditions of locomotive service, and to demonstrate the probability of the decomposition of the salt by removing, as far as possible, all elements that might lead to error in the results.

The first test was made with the raw water as delivered to the tank by the air lift. As before, the boiler was cleaned prior to the beginning of the test and 75 gallons were evaporated to one gallon. The reason for the selection of 75 gallons as the quantity to be evaporated was because 75 to 1 was about the ratio of evaporation occurring in the boilers in service during the periods between washouts and it was the best approximation that could be made to road conditions.

The results of the test in which the raw water was used are shown in the following analyses:

Impurities	Grains per gallon	
	Raw water	Concentrated water
Calcium carbonate	10.44	2.51
Calcium sulphate	48.59
Calcium chloride	19.71
Magnesium carbonate	3.15	...
Magnesium chloride	23.92
Sodium sulphate	1.45	...
Sodium nitrate	1.75	91.10
Sodium chloride	1.45	67.33
Silica35	.29
Alumina and iron oxide11	.29
Organic matter81	18.84
Total	19.51	272.58

The recovered sediment weighed 1,091.14 grains and with one gram taken for analysis the following results were obtained:

Calcium carbonate and sulphate	76.72 per cent.
Magnesium hydroxides and carbonate	15.48 per cent.
Alumina	2.36 per cent.
Ferric oxide64 per cent.
Silica	2.80 per cent.
Organic matter84 per cent.
Water	1.06 per cent.
Total	99.90 per cent.

The distilled water collected in the condenser contained:

Totals solids per gallon52 grains
Ammonia per gallon22 grains
Chlorine per gallon58 grains

With this definite data in hand a similar test was made with the same water treated with enough slacked lime to precipitate

the carbonates. For this purpose 66 grams (102.85 grains) of slacked lime was added to 75 gallons of water. The precipitates were allowed to settle and the water filtered before starting the test, which was conducted in the same manner as the one already detailed.

The analysis of the treated and concentrated water was as follows:

	Grains per gallon	
	Treated	Concentrated
Calcium carbonate	1.40	7.28
Calcium sulphate	5.85
Magnesium carbonate40	...
Magnesium chloride	3.09
Sodium sulphate	1.11	44.10
Sodium nitrate	1.75	108.85
Sodium chloride	1.40	63.06
Silica35	.35
Alumina and iron oxide23	.29
Total	6.44	232.87

This test is of especial interest because of the marked chemical changes that took place in both the raw and treated water under the high pressure and temperature at which the evaporation took place. The most remarkable of these changes was the disappearance of the common salt.

In the raw water the salt amounted to 1.45 grains per gallon or 108.75 grains in the 75 gallons, while but 67.33 could be accounted for in the concentrated water and none in the sludge, a loss of 41.42 grains or more than 38 per cent. At the same time the total organic matter in the 75 gallons was 60.75 grains and but 19.68 grains is accounted for in the concentrated water and sludge. Again there was a total of 236.25 grains of magnesium carbonate in the raw water of which none appeared in the concentrated water and but 15.46 grains in the sludge together with the magnesium hydroxide. Finally of the 131.25 grains of sodium nitrate that was in the raw water there was but 91.10 grains in the concentrated water, making a loss of 40.15 grains or about 30.5 per cent. The losses for carbonates are accounted for by precipitation.

On the other hand there was no magnesium chloride or sodium sulphate in the raw water, while there was 19.71 grains of the former and 48.59 grains of the latter in the concentrated water. These compounds must have been built up by the decomposition of other compounds in the raw water.

Attention has already been called to the fact that common salt is one of the most stable of compounds and that it has been considered impossible to decompose or break it down by boiling the water in which it is dissolved, even though carried to the point of saturation with the consequent precipitation. The writer, however, is not aware that investigations have been made as to the effects of the high pressure and temperature obtaining in these tests. The loss of the salt may be accounted for by the breaking down of the organic matter present.

We have seen that there was a decided loss of organic matter and also the development of some ammonia and free chlorine. It is well known that ammonia has a greater affinity for chlorine than has sodium, while magnesium follows closely after sodium. Hence, when the organic matter contained in the water was decomposed with the release of ammonia, the latter attacked the salt and broke it down by robbing it of its chlorine.

The appearance of magnesium chloride in the concentrated water fully explains the corrosive action, for it is broken down with comparative ease and converted into hydrochloric acid that will make a direct attack on the sheets.

The same chemical changes, but of different quantitative values occurred in the tests of the lime-treated water. With this there was no apparent corrosion. This probably may be explained on the basis of a much smaller development of magnesium chloride, thus diluting the corresponding amount of hydrochloric acid developed to such an extent as to render it harmless. The air, too, that was contained in the raw water probably had a direct influence in promoting some of

the changes that took place, especially in furnishing the oxygen for the formation of the magnesium hydroxide found in the residue.

The removal of this air by the lime treatment apparently prevented that formation from occurring in the second test and so made the water suitable for boiler purposes.

These investigations have been discussed in considerable detail because, so far as is known, it is the first time that the solution of water difficulties has been approached in this way.

The difficulty of explaining phenomena of daily occurrence from analyses of the raw water alone indicated the possibility of chemical action within the boiler and the developments seem to have demonstrated that the boiler of a modern locomotive is a chemical laboratory of almost infinite possibilities. The tests suggest that many of the unsatisfactory results obtained from the use of proprietary compounds have been due to a failure to adapt them to this condition.

The results of the investigation have served to convince those engaged in it that there is no cure-all for boiler troubles, and that the individual remedy must be found for each local or regional trouble. Whatever the trouble may be, an effective remedy can be found if the problem is attacked with a proper spirit of patience and thoroughness and the reactions of the water under working conditions determined. It is well to make a careful diagnosis of the disease before prescribing a remedy.

FUEL ECONOMY AND PROPER DRAFTING OF LOCOMOTIVES

BY D. R. MAC BAIN,
Superintendent Motive Power, New York Central

The drafting of locomotives is a subject which has had a lot of attention during the past twenty years, or such a matter, but in the past eight or ten years, during which time the greatest strides in the history of locomotive design and construction have been made, very little attention has been given the matter, everyone doing about as he pleased so long as fair results were forthcoming.

The modern practice of much better proportion of heating surface to cylinder volume than was common eight or ten

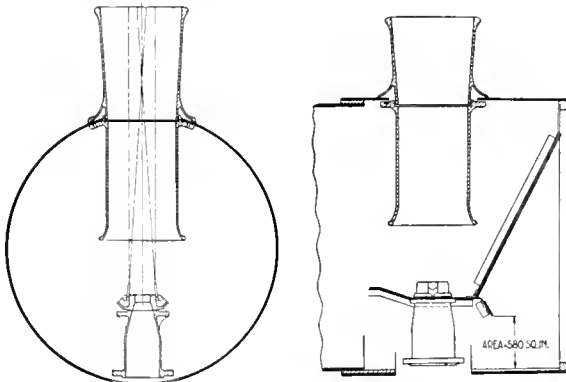

Fig. 1—Standard Front End With Twin Blowers Turned On

years ago has made the getting of steam a lot easier than it used to be, and this fact, in my opinion, is responsible for a very considerable waste of fuel in many instances.

Six or seven years are factors which have lessened the difficulty formerly experienced in making steam at all times and under all conditions of service. In fact, with inferior coal, the locomotive of today, owing to its superior proportion over what used to be common, is a better all around steamer than was the engine of ten years ago, and the addition of superheaters and brick arches has, on the better designs of

locomotives and ample boilers, practically wiped out the old alibi for engine failures, such as "poor coal," "dirty fire," etc.

Although we may all be enjoying great freedom from steam trouble at this time, this does not mean that we are producing our steam as economically as it should be done. On the contrary, my own personal observation in riding about the country forces me to the conclusion that the proper drafting of locomotives, with a view of consistent economy, is a subject which for some time has been much neglected and is now in need of serious attention.

Fig. 1 is a cross section of a standard front end, showing twin blowers, with $\frac{3}{4}$ in. nipples, turned on. It will be noted that the jets from these blowers combine at a point near the top of the stack, but no part of the jet touches the walls. Readings of the vacuum caused by the blower action were taken on locomotives just out of shop with 200 lb. boiler pressure. Vacuum tubes were located in smoke-box in front

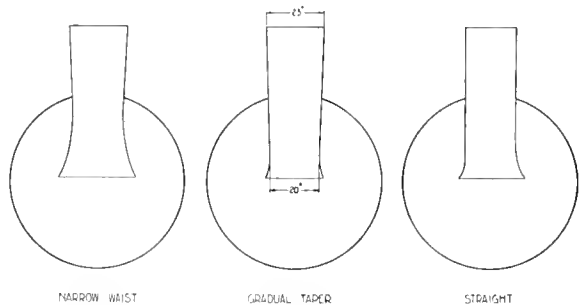

Fig. 2—Types of Smoke Stacks In General Use

of the netting, in the smoke-box in front of the diaphragm under stack, in the smoke-box back of the diaphragm and in the firebox at the center and about 12 in. above the grates.

With one blower turned on full, the readings in the order named were: 1.5 in. of water; 1.45 in. of water; 1.1 in. of water, and .4 in. of water. With two blowers turned on full the readings in the same order were: 2.6 in. of water; 2.6 in. of water; 1.9 in. of water, and .6 in. of water.

This demonstration showed clearly that the steam jet, whether from the blower or the exhaust, does not have to fill the stack in order that draft on the fire may be created. On the contrary, if the jets from the blower were trained on to the walls of the stack the extent of the vacuum would be materially reduced. I believe that a good liberal space around the steam jet at the top of the stack should be provided as an outlet for the induced or entrained gases to pass through to the atmosphere. Certainly if a jet of steam from a blower or pair of blowers, which at the most will not exceed 15 in. in circumference, creates enough draft to overload two $2\frac{1}{2}$ in. pipes, a jet of, say, 50 in. to 54 in. in circumference ought to, and does, do all that is needed in the way of creating the necessary draft in a locomotive front end, tubes and fire-box. As indicated in Fig. 1, the area under the deflector is 580 sq. in. The smallest diameter of the stack is 315 sq. in., the largest diameter of the stack 415 sq. in., and when we consider that the same number of cubic feet of gases that pass under the deflector plate each second must, in addition to the volume of the steam jet, pass through the smoke stack in the same unit of time, crowding is suggested. Restricted openings through the smoke stack makes necessary increased exhaust jet velocity, and this is usually produced by reducing the exhaust nozzle. Reducing the exhaust nozzle, at high speeds, especially, results in greater back pressure in the cylinder and decreased engine efficiency is the result.

It would seem, therefore, that if anything can be done to avoid speeding up the exhaust jet in order that sufficient draft

may be had to properly burn the fire, we should give the matter our serious consideration.

Adding the area of the ash pan openings on the class of power we have under consideration we have the following comparison:

Ash pan	750 sq. in.
Under deflector	589 sq. in.
Smallest diameter of stack.....	314 sq. in.
Largest diameter of stack.....	415 sq. in.

Is it not possible to decrease the velocity of the steam jet

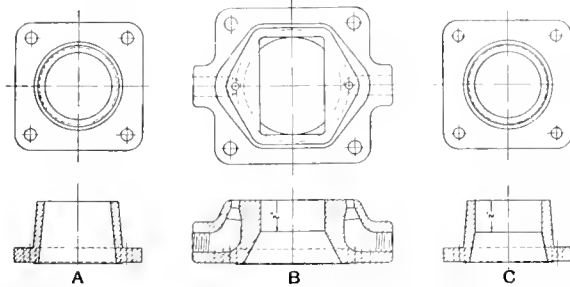

Fig. 3—Rectangular and Round Exhaust Nozzles

by increasing the areas through the smoke stack? I believe it is, and in the course of the evening I hope to demonstrate how it may be done.

Fig. 2 represents the three types of smoke stacks in general use on the power of the present day, the choke or narrow waisted stack, the straight line stack, tapering outward from the bottom up, and the straight stack. There is no useful purpose ever served by the choke, although if the area at the choke be sufficient it probably does no harm.

A gradual taper, in our opinion, is the right idea for a stack. In increasing the diameter from the bottom up it conforms to the outlines of the steam jet as it expands after leaving the nozzle, and affords at the top the necessary free space for the egress of the gases from the fire-box. A straight

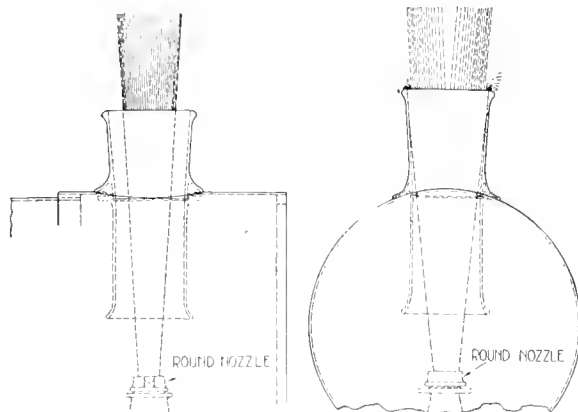

Fig. 4—Action of a Round Exhaust In the Stack

stack, if large enough in diameter, may be placed on a par with one of gradual taper, but my observation has been that this type of stack is almost invariably too small, and is noted most for noise, and this noise costs money.

In Fig. 3 you will note there are two designs of the round nozzle, and one of the rectangular. A shows the tapering outlet round nozzle, and C the straight bore, or vertical wall, outlet of the same type, while B illustrates the rectangular nozzle as now in use on several railroads in this country. It will be noted that figures B and C have outer

walls machined vertically for a depth of 2 inches, while figure A tapers inward from its base up. The long inward taper or A has no useful function that I can conceive of, so we will confine our remarks to B and C which have the vertical walled 2-inch outlets, for the balance of the taper.

For a good many years I had observed from my office window, and from positions alongside of the track, when trains were passing at high speed, and when the fire was burnt out clean, that the steam jet in issuing from the stack occupied a comparatively small area of the whole opening, that is to say, the jet seemed to be only about one-third of the diameter of the stack when viewed from the side; while, on the other hand, when viewed from the front or rear, in the latter case from the cab, the jet seemed to fill the stack, to the bulging point, so to speak. The nozzles used when these observations were made were the round type, as shown, A and B in Fig. 3.

A few years ago I became interested in the subject again through the peculiar action of some large Pacific type engines, with reference to the burning of the fire under certain conditions of service. These engines were of splendid design and of proportions that are today, perhaps, as good as any in the country, and I knew they should make steam freely when the fuel was even fair. For a certain amount of cut-off and a certain length of throttle, at speeds up to 70 miles per hour, they did fairly well, but if they were

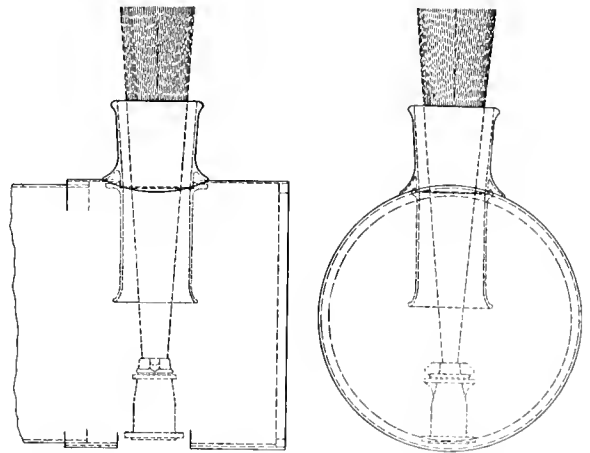

Fig. 5—Action of a Rectangular Exhaust Nozzle In the Stack

crowded either in cut-off or throttle, only a very little, the fire in the fire-box would redden up and the steam pressure would gradually drop back. In other words, these engines, which were equipped with round nozzles, plenty small enough I assure you, limited for themselves the amount of crowding they would stand.

Frequent observations made from the side and the cab developed that the peculiar filling of the stack referred to a moment ago, prevailed even to a more marked degree, especially when viewed from the front or rear, the smoke seeming to roll over the sides of the top of the stack in great volume.

When running slowly these engines shot their exhaust first to one side and then to the other, alternating as the exhaust came from each cylinder, in other words, they cross-fired badly, and this, with other observations made, led me to believe that in this cross-firing lay the cause of our difficulty.

Fig. 4 shows a side and rear view of the steam jet as referred to. You will note in the side view that there is a large amount of space in front and behind the jet, while in the rear view the stack seems to be overfilled and "spilling" over the sides. Our next further thought on the matter w...

how we might stop the "spilling" over the sides, which we knew was the result of the cross-firing of the exhaust, as explained, and we set about to remedy the trouble.

First we made a stack 16 in. by 24 in., of sheet iron, and put it on one engine for trial, the long dimension being across the smoke arch. This was done with the idea that the cross-fired exhausts would pass out at the top of the stack without sliding up the sides of same. So far as this feature was concerned, the remedy was all right, but other evils were produced that were even more troublesome than any we had had up to the time this experiment was made, in short, while one side of the wide stack was filled nicely, the other side was very empty, so much so that we had practically no draft on the fire at very slow speed, and very little at any speed.

Believing still that the cross-fired exhaust was the cause of the trouble, and having failed to accomplish anything by letting it pass out of the stack without side friction, our next thought was to try to train that exhaust to travel the "straight and narrow way," as it were.

Our experience up to this time showed conclusively that the stacks were overfilled at the sides and underfilled at the front and back, and a correction of this condition seemed very promising of results.

We were able to fill the front and back satisfactorily by putting a bridge across the nozzle, but we did not remedy

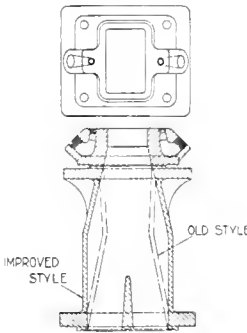

Fig. 6—Rectangular Exhaust Nozzle with Improved Exhaust Pipe

the side condition, nor was there any perceptible improvement in the steam making with the same nozzle opening. Then the thought of narrowing up the steam jet and straightening its course out of the nozzle, suggested a nozzle of the rectangular design.

Fig. 5 is a side and rear view of the exhaust jet after the rectangular nozzle was applied. The nozzle was of greater area than the round nozzles used by about 20 per cent., yet the results were all that could be desired in the way of steam making. The remedy was entirely due to shaping the steam jet so that it did not scrape up the sides of the stack, thereby reducing the induction or entraining area. The change made caused the jet to pass up straight through the stack, leaving the full circumference of the jet exposed to the gases. The result was that the fire burned white when the engine was being crowded, and the full limit of the boiler capacity became at once available.

Fig. 6 shows the design of rectangular nozzle now in use, also the design of exhaust pipe which, in my opinion, gives the best results.

In conclusion, I want to suggest, as a means of decreased fuel consumption and increased engine efficiency:

First: Correct the passage of the steam jet so that cross-firing does not occur.

Second: See that the jet passes out of the top of the stack leaving two or three inches of space all the way around for the entraining or induction of the gases.

Third: Use a plumbing bar in setting of exhaust pipes, nozzles and smoke stacks.

Fourth: Make joints at the bottom of the exhaust pipe and between the exhaust pipe and nozzle tight.

Fifth: If the stacks are too small to allow for the necessary space around the jet at the top, make them larger. I am sure such conditions will bring good results.

AIR PUMP STRAINER

An air pump strainer, the construction of which is shown below, has been developed by the Canadian Northern and is being applied generally to the locomotives of that road. Owing to the extremely low temperatures which prevail during the winter months in the territory through which the Canadian Northern operates, train line leakage is excessive. The simple type of air pump strainer generally used not only considerably restricts the capacity of the air pump to meet the excessive demands upon it, but due to the readiness with which it becomes obstructed in cold weather is dangerous as well.

The strainer shown materially increases the air pump

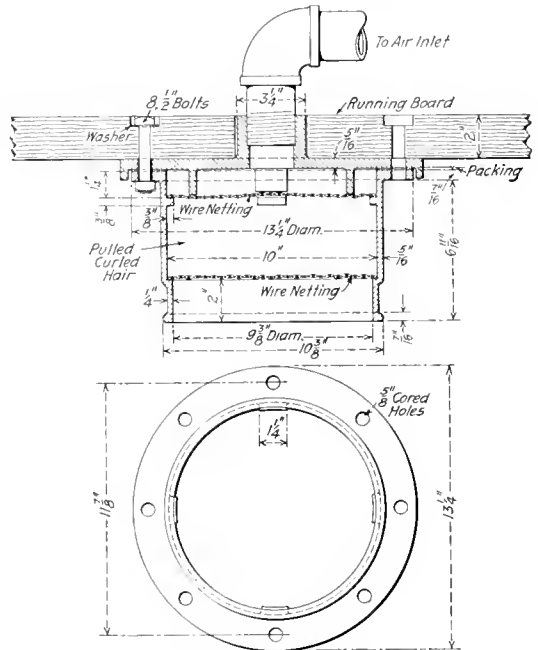

Air Pump Strainer In Use on the Canadian Northern

capacity by providing a much less obstructed air inlet passage and because of the large inlet area is not liable to become closed with an accumulation of snow and ice. It is simple in construction, may be taken down readily and is so located that the air cylinders cannot be lubricated by pouring oil through the strainer.

The body of the strainer is made up of two iron castings. The top casting is placed underneath the running board and at the center has a pipe boss which extends up through the running board. To this boss is attached the air pump inlet pipe.

The lower casting is filled with pulled curled hair placed between two discs of front end netting, and is held in place by eight 1/2-in. bolts, which secure the strainer to the running board. The joint between the two castings is packed and there is no possibility of snow or moisture being drawn into the pump, as all air first passes through about 3 3/4 in. of curled hair, the exposed area of which is sufficiently large to provide against a strong current at the inlet.

Car Department

PENNSYLVANIA RAILROAD REFRIGERATOR CARS

With a view to utilizing every means available to provide a car which will furnish and maintain adequate refrigeration for milk and cream, the Pennsylvania Railroad has recently designed and built two refrigerator cars which, in many

5. The bulkhead, in front of the ice chamber, should be solid, with an air inlet into the ice chamber, close to the ceiling, and an outlet into the car, close to the floor. The bulkhead should be made of non-conducting material, or should be insulated to promote dry refrigeration.

6. The floor should be smooth, to permit sliding the milk cans into place, and to provide a flat base for racks when the

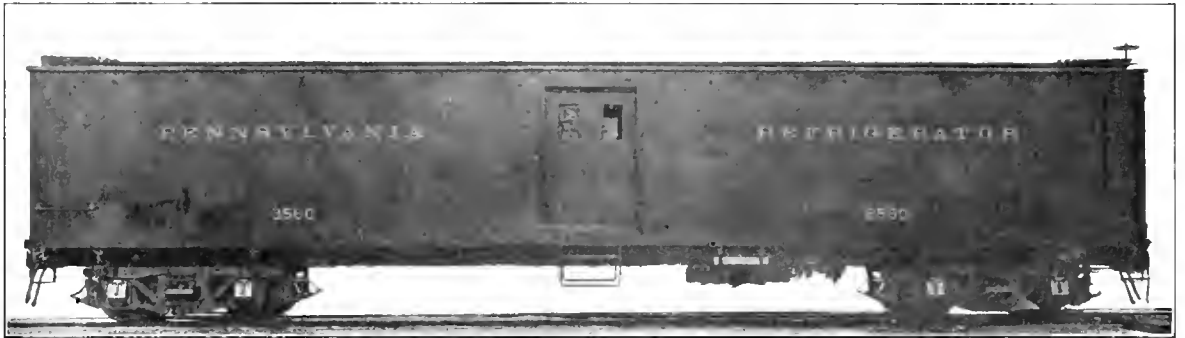

Refrigerator Car With Three Compartments for Rapid Loading

respects, represent a distinct departure from past practices. The cars are designed to use ice either on top of the cans or in the bunkers and are also adapted to the shipment of other commodities than milk and cream.

Past experience and experiments made some years ago indicated the following basic requirements:

1. An inside lining that is watertight and keeps moisture away from the insulation.
2. Adequate continuous insulation fully surrounding the

car is used for other shipments for which an air space under the lading is of advantage.

Two cars, differing from each other slightly, for experimental purposes, have just been completed and turned out of the Altoona Car Shops.

Car No. 2500, class R 50, is not partitioned; all of the space between ice baskets is in one compartment. The side doors are of the usual refrigerator type, and open outward.

Car No. 2550, class R 50a, has the space between the ice

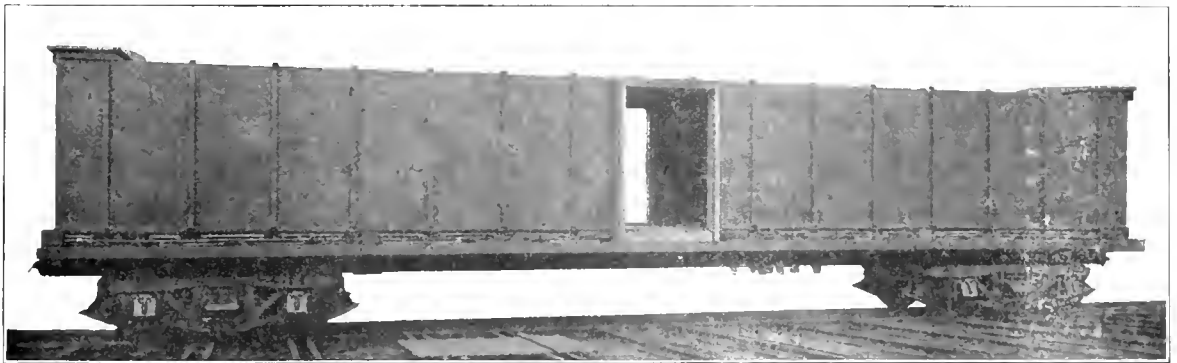

Inside Box on Undeformed: Insulation Under Floor

inside lining. The amount of insulation under the roof, which is liable to be heated excessively by the direct rays of the sun, should be greater than that in the sides and bottom.

3. The outside sheathing and roof should be weathertight.

4. The vertical air space around the ice baskets and through the ice should be adequate.

baskets divided into three compartments, by means of two insulated wooden bulkheads. The middle compartment is 6 ft. 2½-in. long, and is used for quick loading and unloading of cans and boxes from and to station platforms. The cans and boxes can be transferred to or from the other two compartments, which contain the refrigerating means.

while the train is in motion. In this car the side doors are of light construction, and the insulated refrigerator doors are in the two partitions. With the exception of the differences just mentioned, these two cars are exactly alike.

The trucks are of special construction. The side frames are of cast steel. The side frame center opening, the spring plank, and the 5-ft. 6-in. wheelbase are the same as in freight trucks. The elliptic springs and bolster are the same as used on tenders; the bolster has no side motion. The ends of the frame are arranged for helical springs over the journal boxes and clasp brakes. The axles are of the passenger type, with 5 1/2-in. x 11-in. journals, and the wheels are forged steel, 35 in. in diameter. The journal boxes are pedestal type passenger car boxes. From this it will be seen that the

Oak blocks are placed on the end sills and crossbearers to support the steel box forming the inside lining. The spaces between these blocks are filled with insulation, consisting of four layers of 3/4-in. Keystone hair felt, separated by wooden grids to form air spaces.

The inside lining consists of 3/16-in. floor plates, 1/8-in.



Truck Which Combines Passenger and Freight Features

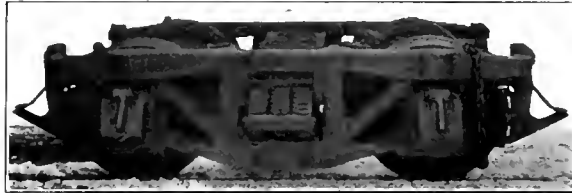

Side of Truck, Showing Spring Arrangement and Clasp Brakes

truck represents a combination of passenger and freight truck features.

The underframe also combines passenger and freight principles. Bolsters have been omitted, and cantilevers to support the side bearings have been substituted. The load is carried on the end sills and crossbearers, whence it is transferred to the center plate through the center sills. The center sill construction is of the box type, consisting of two 15-in., 40-lb.

side sheets and 3 3/2-in. ceiling sheets, all reinforced with U-shaped braces riveted to the outside. It forms a box which can be built up complete on the floor and then lifted to its proper location on the oak supports. The 3/4-in. Keystone hair felt, of as great width as can conveniently be manufactured and cut to the proper length, is then lifted to the top of the lining box and unrolled to drop down the sides to meet and join the insulation under the floor. A continuous blanket is thus formed all around the inside box. There are four such blankets running transversely, separated with wooden grids, made of 1/2-in. strips of soft wood. Two additional layers, separated with wood grids, are placed

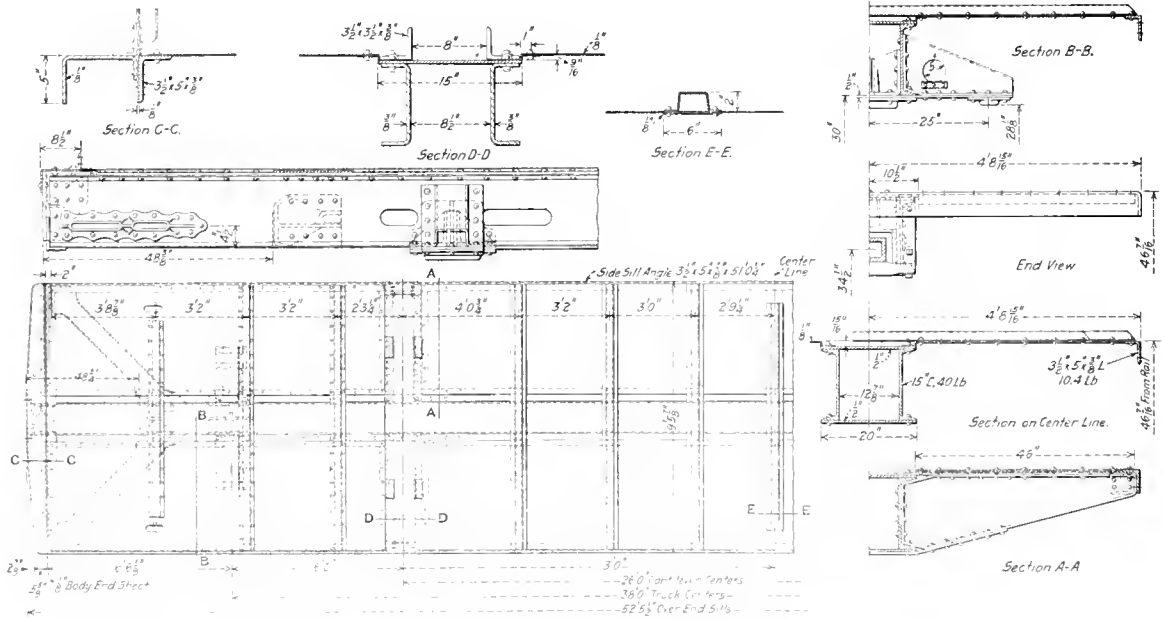

Underframe of the Pennsylvania Refrigerator Cars

channels, spaced 127 1/2-in. apart, and two 1/2-in. by 20-in. coverplates. The side sills are 3 1/2-in. by 5-in. by 3/8-in. angles. The spaces between the center sill coverplate and the side angles are covered with 1/8-in. steel plate, reinforced with U-shaped stiffeners, riveted on top. The back follower stop and front bumper castings are of the integral type used in freight cars. The center plates are drop-forged steel.

longitudinally on the top of the box, and four layers are placed at the car ends to correspond with the sides.

The Keystone hair felt referred to consists of 3/4-in. hair felt placed between two sheets of 90-pound specification paper, and securely sewed together.

After the insulation has been applied, the sides, ends and roof are attached. These parts are also reinforced with

U-shaped braces, and are so designed that the riveting can all be done from the outside. This also permits removing a side, end or roof, for repairs, without disturbing any other part of the car. The connections between inside and outside steel shells are wood. The drains are made of indurated fibre. Hence there are no metal connections between the inside and outside steel shells.

The ice baskets are of the same construction as now standard on other Pennsylvania Railroad refrigerator cars, the

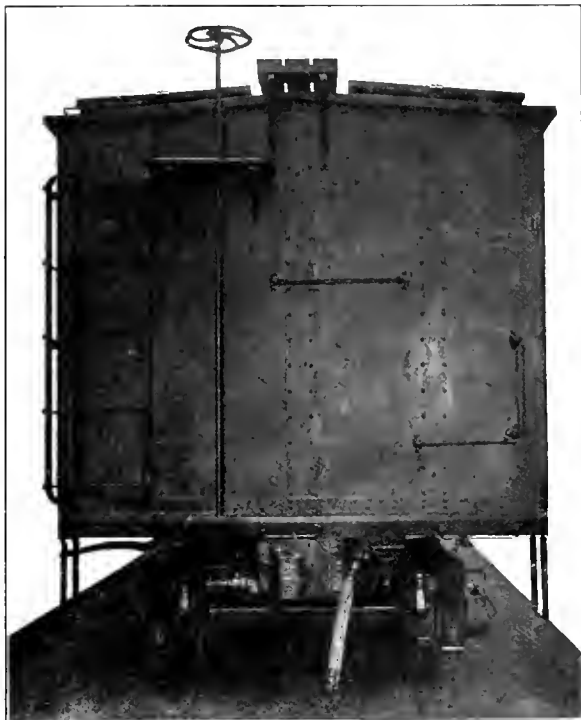

Hand-Brake End of Refrigerator Car

bulkhead in front of each ice basket being made of two courses of wood with an air space between them.

The general dimensions follow:

Length over inside sills.....	52 ft. 5 1/2 in.
Length between ice chamber bulkheads.....	42 ft. 8 1/4 in.
Width over sheathing.....	9 ft. 6 3/8 in.
Width over roof.....	10 ft. 0 3/4 in.
Width inside.....	8 ft. 5 5/8 in.
Height inside (average).....	6 ft. 9 1/4 in.
Weight of car, empty (lb.).....	78,000
Ice capacity of baskets (lb.).....	10,000
Loading capacity (lb.).....	50,000
Loading capacity (cu. ft.).....	2,450
Distance between centers of trucks.....	38 ft. 0 in.
Total wheelbase.....	43 ft. 6 in.

DESIRABLE FEATURES FOR GOGGLES.—In Technical Paper 102, published by the Department of the Interior, J. A. Watkins, of the United States Public Health Service, enumerates the following features as desirable in goggles intended to protect the eyes from the injurious effects of intense light: 1—Should shut out harmful rays. 2—Reduce the retinal image to a safe brightness. 3—Not unduly hinder vision of other objects besides those on which the employee is working. 4—Be light in weight, well fitted and as comfortable to wear as possible. 5—Have no metal parts that touch the skin. 6—Be fitted with a flange back of each lens so as to prevent glass from entering the eye in case the lens is broken by flying objects. 7—Be of such coloring that color perception is not unduly disturbed.

THE HOT BOX—ITS CAUSE AND CURE*

BY J. F. LEAKE
Chief Joint Inspector, Chattanooga, Tenn.

The principal causes of hot boxes, in my opinion, may be classified under the following heads: (1) Lack of lubrication. (2) Rough journals. (3) Bad journal bearings. (4) Overloaded cars. (5) Trucks out of alinement. (6) Lading improperly distributed.

(1) Improper lubrication is due largely to the packing getting hard and clammy and falling away from the journal, thus cutting off contact between the oily waste and the journal; the result is inevitably a hot box. To eliminate this cause for hot boxes, good material should be furnished. Wool waste is the best because of its elasticity. Capable and honest men should be used. Most roads depend on the oiler solely to do the inspecting of oil boxes, journals and journal bearings, and the necessity of good men is obvious. I have known instances where old men were used simply because they were not able to do other work. The disposition to keep old men at work so they can earn something in their declining years is commendable; however, I am of the opinion that the men who watch and keep the packing in a box so it will come in contact with the journal, should be honest, capable and in possession of all their faculties. Especially would I emphasize eyesight.

(2) Rough journals may result from seams in journals, due to flaws in the metal, which will develop after the journal has been in service for a time; also cut journals usually caused by hard spots in bearings. When journals become thus defective no amount of brassing or lubrication will overcome the trouble. Hot boxes are the result and the wheels must be removed or the journals dressed before the trouble is overcome. To prevent defects of this nature, the service of an expert oiler will be required—one who can determine when a journal requires attention before it reaches the point of causing a hot box.

(3) There are two reasons why a journal bearing will cause a hot box. One is the fact that it has been allowed to run too long before removal. The other is because of bad alloys in the metal which result in hard and soft spots causing uneven wear. A journal bearing in this condition, or one that has been allowed to wear thin and become distorted or broken, will cause journals to run hot. Here again the expert oiler is required, as he should be able to say when a bearing should be removed, or report on a lot of bearings that are giving trouble, so the test department can locate the exact cause.

(4) Overloaded cars cause a great many journals to run hot. The remedy is living strictly up to rules and instructions with regard to weighing and properly handling overloaded cars.

(5) Trucks out of alinement will cause journals to run hot, and may be eliminated by insisting that the inspectors see that the trucks are kept squared up and are running properly.

(6) Improper distribution of lading should be watched by inspectors. Cars found with lading unevenly distributed should be held for correction. This trouble is more often experienced with baggage cars.

The chief inspectors and the train crews especially should keep in touch with each other so that each may keep posted as to the cause and handling of hot boxes on the road. Generally the last man hired on train crews is the one who handles the hot boxes. He furnishes information on which reports are made to the superintendent. These reports go to the master mechanic and finally find their way to the oiler, sometimes with awful force. I have known good and loyal men to be relieved of their jobs because of persistent reports

*Entered in the Hot Box competition, which closed on October 1, 1916.

from train crews; hence the necessity of co-operation and correct information.

Summarizing, we must have good packing. We must have reliable men to apply it and report conditions. We must have intelligent co-operation between the different departments. When this is done, we shall have made great strides toward eliminating the hot box and its resultant dangers.

SUGGESTIONS FOR A CAR DEPARTMENT APPRENTICE COURSE*

BY J. H. DOUGLAS

Freight Foreman, Wheeling & Lake Erie, East Toledo, Ohio

Because of the rapid development in the construction of freight carrying equipment and the efforts of car department officers to design and get into service a car from which maximum service with minimum expense for repairs may be expected; also because of the enormous expense involved in shop machinery and equipment to bring about ideal conditions in freight transportation, the need of a car department apprenticeship course whereby young men may be given a thorough training in the details of car construction and maintenance is daily becoming more imperative.

The car department apprentice should be a young man having at least a high school education. At the start he should be given light repair work. After possibly one year in this service he should be transferred to the heavy repair shop for a like time. At this time the apprentice should be in a position to know the weak points in the average freight car and to know the practical side of repairing cars. He should then be placed in the transportation yards for about six months as an inspector where he could learn how the defects are caused and also just what service is expected of the different classes of cars. After his yard training he should be placed with a good reliable inspector at some interchange point where he could obtain a full and comprehensive knowledge of handling cars in interchange, as well as a thorough understanding of the Master Car Builders' rules. The time spent in this work will depend entirely on the apprentice himself; some will grasp the situation and learn to apply the rules more readily than others, but a general idea of this particular feature of car department work must be obtained before the apprentice is ready for the next step.

The apprentice should then be given a six months' course at the bill desk in order that he may become thoroughly posted as to the actual manner in which bills are rendered and also to become conversant with the kind of information required of the shops and repair tracks before proper billing is possible. The drafting room should be the next step and here the apprentice should be allowed to develop any ideas he may have thought of during his previous training. In the drafting room he can familiarize himself to a great extent with the technical features of car construction and during this time different designs of cars and the Master Car Builders' publications should be studied. The reading of railway magazines should also be encouraged,—in fact, everything should be done to familiarize the apprentice with different designs of draft gears, trucks, underframes, etc., as well as with the details of car construction. After serving such a course, the apprentice should be ready for the position of foreman and should be equipped to accept promotion as fast as the opportunity presents.

The necessity for such an elaborate course may be questioned, but anything that will tend to solve the problem of keeping the cars in serviceable condition should be welcomed by the managers, and the expense involved in such training will be money well spent. The locomotive department men of the different railroads saw years ago that it was necessary

to train men to take care of the locomotives, and it appears that the car department men are also awakening to the fact that such a course is necessary to insure efficiency in handling cars.

An enormous amount of money has been spent by the railroads in the last 15 years for the purchase of new cars and a small percentage of this amount carefully expended in the training of employees to fit them for the various callings in the car department will be an investment which will produce dividends.

THREE REASONS FOR HOT BOXES*

BY A. L. BARTZ

Road Foreman of Engines, El Paso & Southwestern, El Paso, Texas

Hot boxes are caused by excessive friction, due to too much weight on bearings; improperly fitted bearings; or lack of lubrication. They may be overcome by preventing a car from being overloaded; by properly fitting the brasses on the journals, and by giving more attention to the lubrication of the bearings.

The mechanical defects most noticeable on new cars are improperly fitted bearings, due to a rough journal and rough babbitt on the brass, or the journal being too small for the weight resting on it.

The mechanical defects on old cars are in nearly all cases the same, except for a sprung truck frame, sprung or rough journals and improperly fitted bearings. As a rule hot boxes are caused by carelessness in neglecting to look after the mechanical defects, and also carelessness in packing the boxes. Employees should receive instructions from the general car foreman on how to pack boxes. The latter should receive a report daily as to the number of hot boxes and the causes, if possible. This will give him a chance to remedy the trouble by locating the real cause.

One cause of a loss of oil is allowing soggy waste to remain in the box, and continually putting oil on top of it, which only runs to the bottom of the box. Oil is also wasted by allowing the boxes to run with defective dust guards and defective box covers. As a rule 75 per cent of the waste and oil in a box is a total loss whenever it is necessary for trainmen to pack a box, as the old packing is allowed to remain on the right of way.

Bearings should be fitted properly and then checked every six months, or at the same time the triple valves are cleaned. The stencil on the auxiliary would show when the boxes are to be packed. After a bearing is fitted properly—the babbitt being of a smooth surface and in first class condition—the car repairers should be very particular to prevent any dirt or waste getting between the bearings, or between the wedge and the brass, which allows the weight of the car to rest on only part of the bearing and leads to a hot box.

Boxes which run satisfactorily should be oiled every 300 miles. If it is necessary to repack a box, take out all the old waste, wash the inside of the box, and use good spongy waste saturated in oil. Roll a large piece of waste and force it against the dust guard; then press enough waste between the journal and bottom of the box to keep the waste against the journal. The packing should not extend above the center line of the journal. There is no need of extra oil being put on top of the new packing in a newly packed box.

In a cold climate hot boxes are often caused by the packing freezing in the box; as soon as the car is moved the journal forces the packing out of the box, and the journal is bound to heat after running a short distance. To prevent this put hot oil on top of the packing before the car is moved. Most of the hot boxes could be avoided if the oilers were more careful and examined the old brass and journal, as in most cases the reason for heating will appear on the brass.

* Entered in the Apprentice Competition of the Chief Interchange Car In and Car Foremen's Association and presented at the annual convention, Indianapolis, Ind., October 3, 4 and 5, 1916.

* This article was entered in the Hot Box competition, which closed on October 1, 1916.

FREIGHT CAR REPAIR PROBLEMS*

A Study of Some of the More Important Failures to Freight Equipment and Methods of Repairing Them

BY LEWIS K. SILLCOX
Mechanical Engineer, Illinois Central

ONE of the broadest and most exacting problems facing the mechanical departments of all roads at the present time is that of repairing and rebuilding freight cars. To handle this problem to the best advantage it is very desirable to obtain a definite record of the failures of the various parts of the equipment. It is also desirable to know the percentage of bad order cars located on the road and the output from each shop. The form shown below gives a concise outline of the information desired. It will give exactly the condition of each shop, the type of equipment held, the relative output and the status of the case for the whole system compared with the previous day and the year previous; all of which shows at a glance the general over-all condition of affairs.

DAILY STATEMENT OF CARS IN BAD ORDER AND ON HAND REPAIRED
Date.....

	Division		
	No. 1	No. 2	No. 3
	A-Station	B-Station	C-Station
Box—Held today			
Repaired since last report.....			
Furniture—Held today			
Repaired since last report.....			
Stock			
Refrigerator			
Fruit			
Flat			
Coal (Wooden)			
Coal (Steel)			
Coal (Composite)			
Caboose			
Work			
Foreign			
Totals—Loaded today Empty.....			
Totals—Loaded Last Empty Report			
Totals—Loaded Last Empty Year..			

Per Cent of Total Cars Owned to those in Bad Order.....
Per Cent of Total Cars Owned to those Repaired.....

There are two other reports that can be used in connection with this subject, one being a monthly statement showing the failures to freight cars according to their series and the other showing at what points the failures occurred. These reports will give a comprehensive idea of what obtains in service, but most interesting of all, it gives a very concise form of comparison as between one month or year and another. The car parts to be listed in these statements are given in the table.

REINFORCEMENT FOR WOODEN FRAME CARS

A typical failure of a striking block is shown in Fig. 1. This is bound to occur where there is a large amount of ec-

entric loading and the blow is delivered at the horn of the coupler. One road reports a suggested method of wooden bracing between the striking plate and body bolster as shown in Fig. 2.

Refrigerator cars require an especially rigid structure which

CAR PARTS TO BE LISTED IN THE FAILURE REPORTS

1. Friction Draft Gear.
2. Spring Draft Gear.
3. Uncoupling Attachments.
4. Body Side Bearings—Flat Type.
5. Body Side Bearings—Roller Type.
6. Truck Side Bearings—Roller Type.
7. Truck Side Bearings—Flat Type.
8. Body Bolster—Cast Steel.
9. Body Bolster—Built Up.
10. Truck Bolster—Built Up.
11. Truck Bolster—Cast Steel.
12. Body Center Plate—Cast Steel.
13. Body Center Plate—Drop Forged Steel.
14. Truck Center Plate—Drop Forged Steel.
15. Truck Center Plate—Cast Steel.
16. Journal Boxes.
17. Air Brake Apparatus—Brake Beams—Heads—Fulcrums—Hangers, etc.
18. Coupler.
19. Coupler Yokes—Wrought Iron.
20. Truck Lateral Motion Device.
21. Coupler Centering Device.
22. Truck Spring Plank.
23. Truck Side Frame—Cast Steel.
24. Truck Side Frame—Built Up.
25. Truck Side Spring—Arch Bar.
26. Drawbar Striking Plate.
27. Center Sill—Steel.
28. Draft Sill—Steel.
29. Truck Bottom Connection Rod
30. Truck Brake Hanger.
31. Truck Column Casting.
32. Truck Spring.
33. End Post Steel.
34. Steel Ends.
35. Drawbar Yokes—Cast Steel—Friction Gear.
36. Drawbar Yokes—Cast Steel—Spring.

may be obtained by a series of cross bracing in the roof with 2½-in. by ¼-in. material. One large system has applied such bracing using five sets throughout the length of the car. The hatch was also reinforced by a malleable iron metal



Fig. 1—Typical Example of Striking Block Failure

*Abstract of a paper before the Car Foremen's Association of Chicago.

framing which not only keeps this section of the roof from warping but protects it from damage at the time of icing.

One large road in the Northwest is following the practice of reinforcing their roofs as described, except that 2-in. by 6-in. wooden diagonal tie members are used and bolted into place.

The matter of end frame reinforcement is receiving a great deal of attention. One large Eastern road is applying two pressed steel belled U-braces to the end sheathing over the end posts, a tie rod through the side plates and end plates, angle plates at the belt rails inside and outside of the car in each corner, a 2½-in. by 2½-in. by ¾-in. angle at the end of the side and end plates, a tie rod through the ends just above the belt rail and 1¾-in. flooring to the end lining for about 3½ ft. up from the floor. The angle iron at the side and end plates is in one piece, extending about 4½ ft. along each side plate. It spans each of the corners to avoid sharp bends and is securely bolted to both the end and side plates.

Another road is applying 4-in., 8.2 lb. Z-bars at each end post, 4-in. by 4-in. by 5-10-in. angles at the end plates and

floor plates and the lower part of the side sheets have become corroded to the extent of impairing the strength of the car and causing the lading to be lost through openings in the frame, is a big problem and its solution depends entirely upon the probable life of the car. In the case of some roads, which operate under unfavorable climatic conditions and handle low grade bituminous coal, re-building is necessary at the expiration of from nine to eleven years, but where service

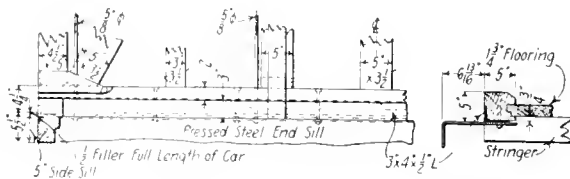

Fig. 3—Grain Tight End Sill for Steel Underframe Cars

conditions are not so severe, the period may be postponed to the fifteenth or even eighteenth year. One road is following the practice of splicing the base of the side sheet as shown in Fig. 4, thus saving eighty per cent of the old material. In the arrangement shown the splice is required to transmit 6,200 lb. when 80,000 lb. is carried by one side. From a material standpoint, a good system to follow would be to have the center sill cover plates 21 in. by ¼ in., and the side sheet splices formed from the same size material and flanged.

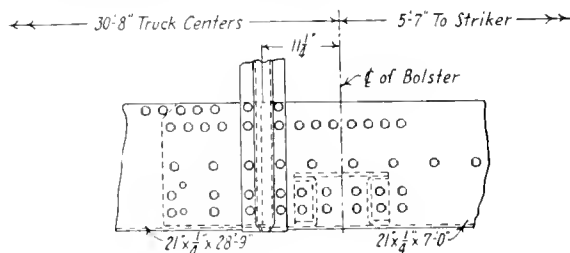

Fig. 4—Detail of Splice for Sides of Steel Coal Cars

In order to keep the sides from bulging, four braces, one located at each cross-bearer and riveted directly to them, were applied. The following is the method of figuring the strength of the splices (See Fig. 4):

Assume 80,000 lb. carried by one side.
Then the vertical shear at the bolster will be

$$S = \frac{80,000}{40.66} + 35.66 = 40,000 = 30,000 \text{ lb.}$$

Where 40.66 = length of car
35.66 = distance from bolster to further end sill.

Therefore the bending moment at the bolster is

$$M = \frac{6 W N^2}{L} = \frac{6 \times 80,000 \times 25}{40.6} = 296,000 \text{ in. lb.}$$

Where W = the load on the side
N = distance between bolster and end of car.

The tension and compression (P) in the top chord and bottom side sheet due to bending moment M is

$$P = \frac{M}{48} = \frac{296,000}{48} = 6,200 \text{ lb}$$

Where 48 = depth of side sheet in in.

Therefore the splice must transmit 6,200 lb.

By using the same material for both the side sill splices and the cover plate splices it can be purchased cheaper and better deliveries will be obtained as the 30-ft. lengths are usually carried in stock. The following is the bill of material for one car:

- Two 21 in. by ¼ in. by 28 ft.—9 in. side sheets (body).
- Four 21 in. by ¼ in. by 7 ft. side sheets (ends).
- One 21 in. by ¼ in. by 29 ft.—5 in. center sill cover plate.
- Two 21 in. by ¼ in. by 7 ft.—3¼ in. center sill cover plates (ends).

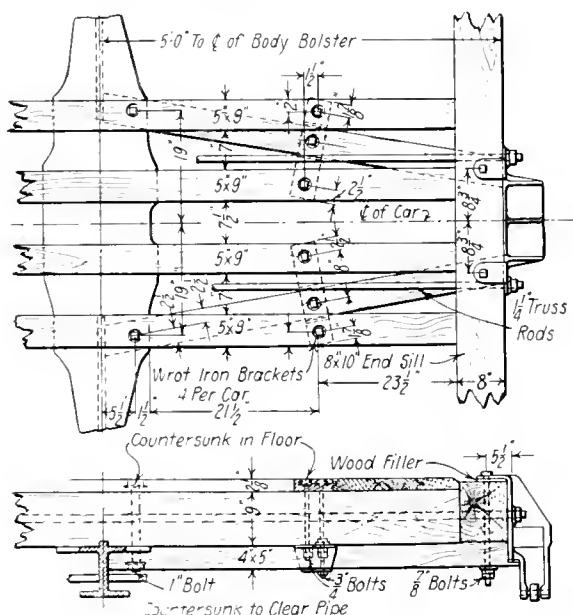

Fig. 2—Method of Bracing Between Striking Plate and Body Bolster

diagonal braces of 3-in. by ¾-in. material, at the corners in the roof, which are riveted to ¼-in. gusset plates at the side plate and ¾-in. gusset plates at the end plate. Another road favors the use of lateral straps, three at each end of the car, made from 4-in. scrap boiler flues, all of which can be applied at a cost not to exceed \$10 to \$12 per car.

Generally speaking, a large number of roads are endeavoring to render additional support to the end plate and centre end posts.

In grain loading, some roads find it necessary to apply metal bands to the outside of the sheathing, in the form of flattened tubes, bar iron or light channel sections. The cost of such applications would probably not exceed \$4 per car. A typical design of grain tight end sill arrangement is that in Fig. 3. It is used on steel underframe cars by one large road.

REBUILDING COAL CARS

The question of equipping all-steel coal cars, especially those of the flat bottom type, for extended service after the

The efficiency of the centre sill cover plate splice is figured as follows (see Fig. 5):

Gross area of plate (A) 5 sq. in.
Section modulus of the plate is

$$S = \frac{1}{6} \times 20 \times \left(\frac{1}{4} \right)^2 = .21$$

Eccentricity (e) due to offset = 1 1/2 in.

Ratio (R) of strength of plate at offset to the strength of the straight plate is:

$$R = \frac{\frac{1}{A}}{\frac{1}{A} + \frac{F}{S}} = \frac{0.2}{0.17} = 0.29$$

That is, the offset reduces the strength of the plate to 29 per cent of the strength of the straight plate.

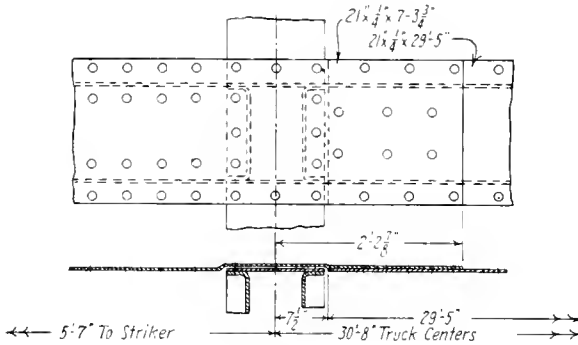

Fig. 5—Splice for Center Sill Cover Plate

The efficiency (E) of the splice is equal to the strength of the riveted joint divided by the strength of the plate.

$$E = \frac{\frac{1}{A \times f \times .29}}{\frac{1}{12 \times V}} = \frac{12 \times 3,000}{5 \times 16,000 \times .29} = 155\%$$

Where V = 3,000 lb. (shear value of rivets)
f = 16,000 lb. (fibre stress of plate)

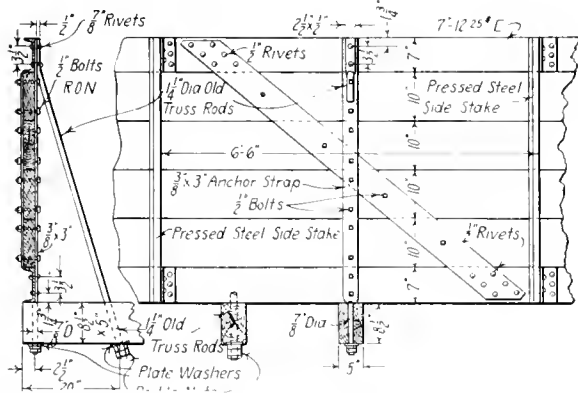

Fig. 6—Side Reinforcement for Steel Frame Coal Cars

That is, the riveted joint is 1 1/2 times as strong as the offset plate.

In connection with reinforcing the ends of steel coal cars, especially where they are used in lumber traffic, it is important to provide against bulging. One road has adopted the use of a double row of pressed steel lateral braces with lipped ends engaging the entire surface of the corner post.

Fig. 6 shows the methods used to reinforce the sides of some steel framed coal cars where eight 1 1/4-in. diameter truss rods were applied to each car and Fig. 7 shows the practice of using 5-in. by 9 3/4-lb. I-beam (removed from

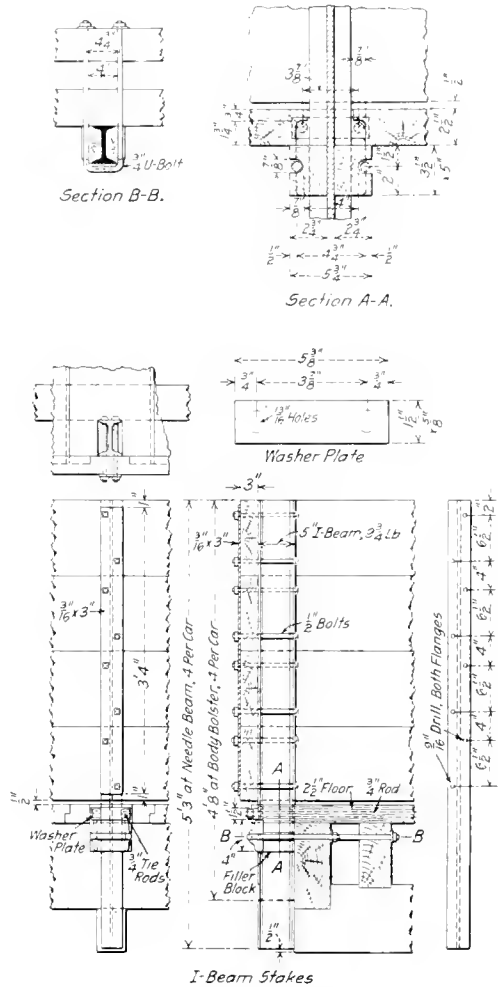

Fig. 7—I-Beam Stakes for Wooden Coal Cars

old brake beams) stakes, eight per car, for 40-ton wooden coal cars and 50-ton steel underframe coal cars.

Fig. 8 shows an economical method of applying planking to the sides of coal cars. The two lower boards are spliced.

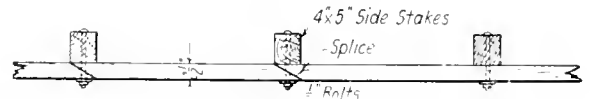

Fig. 8—Spliced Planking for Wooden Sides of Coal Cars

while the upper rows are in one continuous length. No two boards are spliced at the same stake.

The matter of keeping drop doors in good order, especially on general service cars, is a serious problem; it involves the matter of design, deterioration and abuse in service. It is generally agreed that it is impossible to build a door, economically, strong enough to stand both coal and steel mill service, but nevertheless, these are operating problems and the best that may be accomplished is to build the door, so that it

will respond to the action of the operating mechanism without becoming warped or dented. The door can very easily be reinforced by means of angles. One road has developed a two-piece hinge which is keyed in place and admits of easy removal of the doors for repairs, without resorting to cutting out rivets, as the pins on the hinge generally rust in place.

It is often necessary, when considering the matter of reinforcing wooden equipment which has seen service for a considerable period, to provide not only metal draft sills, but new bolsters and crossies, or it may be that the equipment is of large dimensions and needs to be strengthened at the center. Fig. 9 shows a type of framing applied to more than

It was possible in the case of a 50-ton truck recently considered, to reduce the stresses in the bottom arch at the center of the column bolt from 21,000 lb. per sq. in. to 5,000 lb. per sq. in. (practically 400 per cent), by applying a base casting under the columns. Several large roads have recently adopted this practice. This does not mean that liability of failure would be reduced in this proportion, because the most destructive element, namely, crystallization, has not been avoided by the reduction in working fibre stresses above named. As a matter of information, it would be well to appreciate, in this connection, that wrought iron should be used because it has a fibre structure, as against steel which has

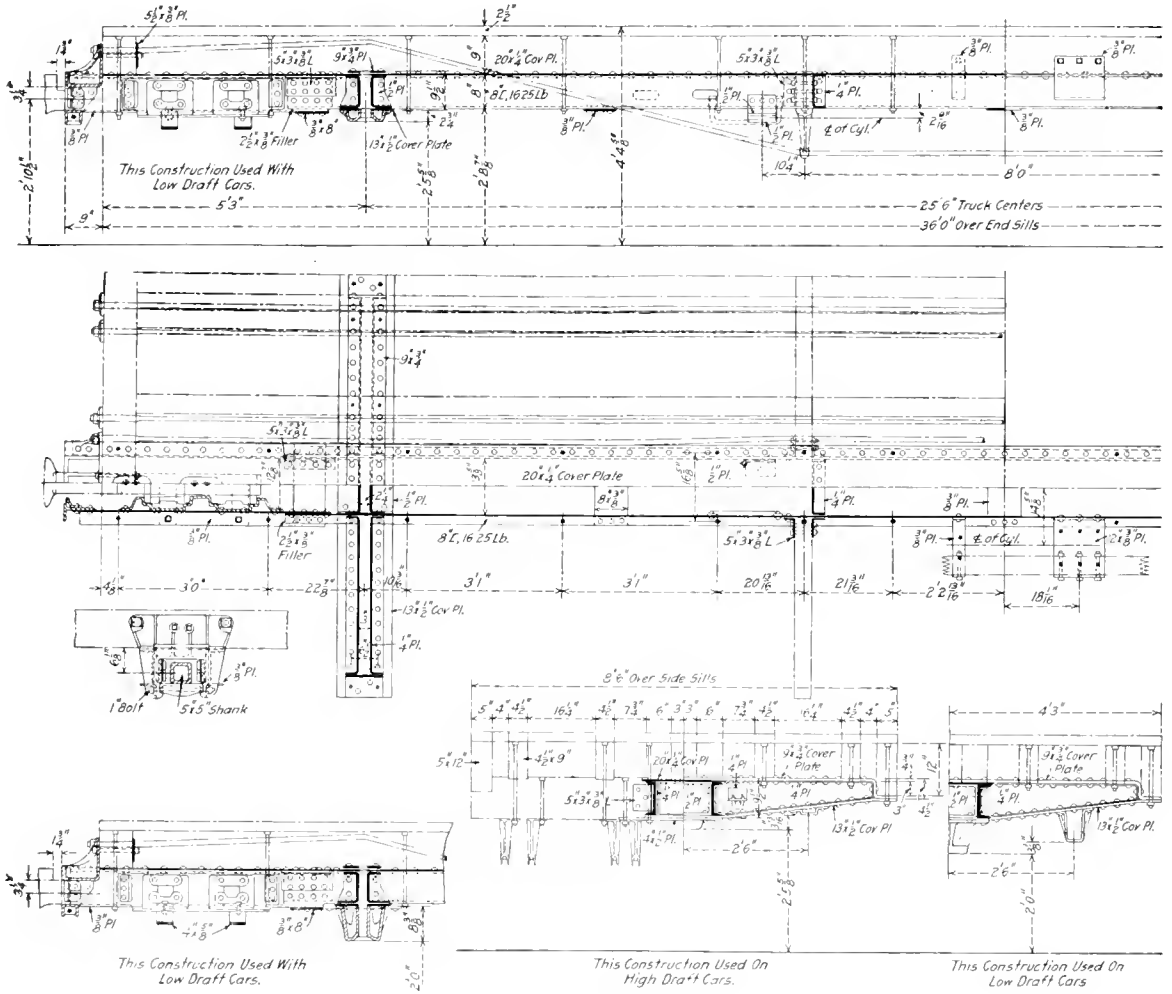

Fig. 9—Reinforced Underframe for 40-ton Coal Cars

3,000 30-foot, 40-ton coal cars operating on a heavy trunk line and is reported as giving excellent satisfaction.

TRUCKS

The question of using a bar section of large breadth for arch bar trucks but having an equal total area presents a problem for discussion. Of two eastern roads operating cars of identical design (they are of the twin hopper all-steel type) the trucks on one road are fitted with 7-in. by 1 1/4-in. bars whereas on the other road 5-in. by 1 3/4-in. sections are used. The net area with the wide bar is 6.27 sq. in., while that of the narrow one is only 5.28 sq. in., a difference of 19 per cent with the same gross section.

none, and for this reason, the latter material will crystallize very rapidly under vibration.

Failure of pressed steel trucks is quite common after long service and riveting a U-section reinforcement 1/2 in. thick over the pedestal can be done economically.

AXLE INSPECTION

The following standard practice covers in plain form a method of presenting the subject of axle inspection to the man on the line. It is the result of very careful calculation and consideration. The great gain in its use appears in the fact that an inspector cannot misjudge the condition of an axle, which often occurs where it is left to his discretion.

No. 1. Standard car axles are provided with 3 3/4 in. by 7 in., 4 1/4 in. by 8 in., 5 in. by 9 in., 5 1/2 in. by 10 in., and 6 in. by 11 in. journals when new.

No. 2. Axles must be removed from service if beyond the following limits:

Normal size of journal	FOR PASSENGER EQUIPMENT CARS			
	Journal dia not less than	Journal length not more than	Collar thickness not less than	Wheel fit not less than
3 3/4 in. by 7 in.	3 1/8 in.	7 1/4 in.	3/8 in.	4 7/8 in.
4 1/4 in. by 8 in.	4 in.	8 1/4 in.	3/8 in.	5 1/2 in.
5 in. by 9 in.	4 3/4 in.	9 1/4 in.	1/2 in.	6 1/4 in.
5 1/2 in. by 10 in.	5 1/4 in.	10 1/4 in.	1/2 in.	6 3/4 in.
6 in. by 11 in.	5 3/4 in.	11 1/4 in.	3/8 in.	7 1/8 in.

Normal size of journal	FOR FREIGHT EQUIPMENT CARS			
	Journal dia not less than	Journal length not more than	Collar thickness not less than	Wheel fit not less than
3 3/4 in. by 7 in.	3 7/8 in.	7 3/8 in.	1/4 in.	4 3/4 in.
4 1/4 in. by 8 in.	3 7/4 in.	8 3/8 in.	1/4 in.	5 1/2 in.
5 in. by 9 in.	4 1/2 in.	9 3/8 in.	3/8 in.	6 1/4 in.
5 1/2 in. by 10 in.	5 1/4 in.	10 3/8 in.	3/8 in.	6 3/4 in.
6 in. by 11 in.	5 5/8 in.	11 3/8 in.	1/2 in.	7 3/8 in.

No. 3. Journals must be calipered to see if they are worn hollow or tapered. If the difference between the diameters of same journal measured at any two points is 1.32 in. or more, the journal must be turned.

No. 4. Axles must be closely inspected for seams, cracks or flaws. Seamy journals may be returned to service if the seams can be removed by turning, within the required limits. Cracked or flawed axles should be tested by painting the doubtful part with whitewash and then holding a

gage of the axle. If the vertical edge of the gage touches the vertical part of the inside of the shoulder, the axle must be scrapped. Use the corner of the gage with the 1/8-in. radius for axles having 3 3/4 in. by 7 in. journals and the corner with the 1/4-in. radius for axles having 4 1/4 in. by 8 in., 5 in. by 9 in., 5 1/2 in. by 10 in. and 6 in. by 11 in. journals.

No. 9. M, C, B. limits must be closely followed in condemning axles under foreign cars in service.

The required clearances for the design of new equipment can be made in the form of a standard practice card and a card of this kind is issued to the new equipment inspectors on one of the largest railroads. Fig. 10 shows an inspector's standard practice card for truck clearances that has been found very serviceable.

THE I. C. C. DIVISION OF SAFETY REPORT

The following is taken from that part of the report of W. H. Belpap, chief of the division of safety, to the Interstate Commerce Commission for the year ending June 30, 1916, which refers to safety appliances:

In order to permit of ready comparison with previous years of the results of inspections of freight and passenger cars and locomotives, some of the principal figures for the fiscal years ended June 30, 1914, 1915 and 1916, are shown in the following tabulation:

	1914	1915	1916
Freight cars inspected.....	790,822	1,000,210	908,566
Per cent defective.....	5.79	4.77	3.72
Passenger cars inspected.....	26,746	33,427	27,220
Per cent defective.....	1.04	2.85	1.82
Locomotives inspected.....	32,761	38,784	31,721
Per cent defective.....	4.98	4.06	3.66
Number of defects per 1,000 inspected.....	67.48	57.23	45.56

A notable feature of the present report is the marked decrease shown in the percentage of equipment inspected during the year which was found defective, the percentage of defective freight cars having decreased from last year's record of 4.77 to 3.72 per cent; the percentage of defective passenger-train cars decreased to 1.82 and of locomotives to 3.66, the percentages for the previous year being 2.85 and 4.06, respectively. This decrease is particularly gratifying in view of the tremendously increased volume of business the railroads have been called upon to handle during the past year, as well as the fact that in addition to maintaining appliances in operative condition carriers were confronted with the necessity of bringing their equipment by July 1, 1916, into conformity with the standards prescribed by the Commission.

A hearing of the carriers before the Commission on September 28, 1915, developed the fact that over a third of a million freight cars would still be unequipped with standard safety appliances on July 1, 1916, and the Commission, on November 2, 1915, granted a further extension of one year within which the carriers shall comply with paragraphs b, c, e, and f of its order of March 13, 1911.

Some difficulty is even now expected to be encountered in equipping the cars in service in accordance with the safety appliance standards prescribed by the Commission before July 1, 1917, the date of the expiration of the time granted for completing this equipment, and in order to expedite the equipment of cars according to the standards the Master Car Builders' Association has adopted as a rule of interchange that after January 1, 1917, no car shall be received from its owner unless properly equipped, and that after April 1, 1917, no foreign cars shall be accepted in interchange unless so equipped. The association is to be commended for this action, as it is probable that only through such a course, together with a system of payment for repairs and alterations, can the standardization of this equipment be accomplished by July 1, 1917.

It has been noted that certain carriers vary the size of their car-repair forces with fluctuations of their business, apparently overlooking the fact that the repairs of the kind required by the safety appliance laws can best and cheapest be made at times when their business is not so heavy. The

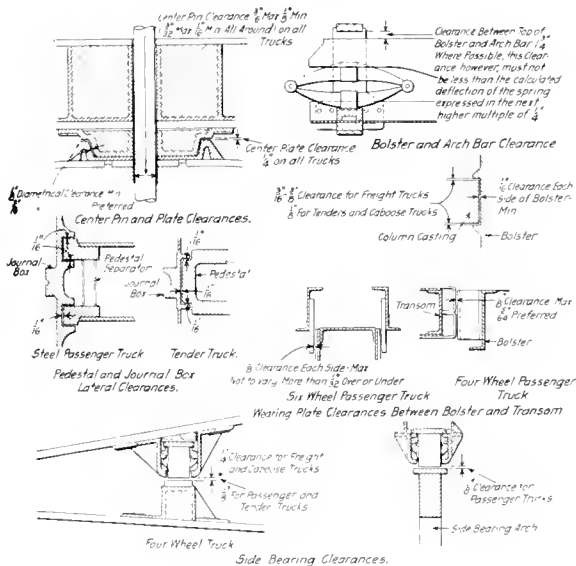

Fig. 10—Inspectors' Chart for Standard Truck Clearance Dimensions

flattener on one end of the journal and striking it with a sledge. Oil working through the paint will indicate a flaw. Axles cracked, flawed or showing signs of excessive overheating or below limits in any respect, must be scrapped.

Defective axles likely to be held for inspection must have in addition to the car number and initials stenciled on the axle, the station symbol, the date removed and defect symbol as follows:

SYMBOL	DEFECT
I	Broken between hubs.
K	Bent between wheel hubs.
L	Fillet at back of journal below limit.
M	Journal length beyond limit.
N	Wheel fit below limit.
O	Good for service.
P	Journal diameter below limit.
R	Cut journal.
S	Burnt journal.
T	Tapered journal.
U	Bent journal.
V	Broken journal.
W	Seamy or flawed journal.
Y	Collar below limit.

No. 5. Scrapped axles should have a piece knocked off the collar.

No. 6. Good judgment should be used in yards and at wheel mounting points in condemning axles. Axles in service should not be removed from cars until worn to the limit, when otherwise in good order. Axles with one or more wheels inserted off must not be returned to service unless 1/4 in. or more above the limit of the journal diameter.

No. 7. Wheel seats must not be turned down except by the smallest amount necessary to true them up, if they require it. Axles must not be turned to fit wheels except when new axles are fitted to new wheels bored to standard dimensions.

No. 8. Fillets on journals must be carefully tried, using a standard fillet gage, placing the gage on the journal parallel with the center line

shortsightedness of a policy that permits material reduction in the force of repairmen and keeps cars standing on sidings unequipped with safety appliances when business suffers some decrease, and requires the employment of a large force of inexperienced men to equip the cars hurriedly when they are needed to take care of increased volume of business, is apparent. The officials in charge of this branch of the carriers' activities should demand that, in order to keep equipment in proper condition, an adequate force of repairmen be maintained at all times. The employment of experienced repairmen is essential to the proper maintenance of safety appliance equipment, and a system of building up a regular force of trained men who are familiar with all the requirements of the law should be more generally adopted.

NUMBER OF DEFECTS PER 1,000 CARS OR LOCOMOTIVES INSPECTED DURING THE YEAR ENDING JUNE 30, 1916.

Couplers and parts	6.09
Uncoupling mechanism	4.17
Visible parts of air brakes	20.58
Handholds	5.00
Heights of couplers	1.08
Steps62
Ladders77
Running boards	2.20
Hand brakes	4.55
Safety railings	0.05
Footboards28
Pilot-beam sill steps06
Handrails08
Steps for headlights02
Power brakes01
Ash pans02
All classes	45.56

During the past year an increase of 1.29 per 1,000 cars inspected is noted in the number of defects to couplers and parts, and the Commission's Accident Bulletin No. 60, for the year ended June 30, 1916, records the death of 123 employees and the injury of 2,194 employees while coupling and uncoupling cars. With the great variety of couplers now in use it not uncommonly happens that proper parts for making repairs are not available, and frequently defective parts of couplers are replaced with wrong castings, the result being that in many cases the couplers fail to operate in the manner intended. After several years of work the coupler committee of the Master Car Builders' Association has recommended the type D coupler, and this type of coupler has been adopted as standard by that association. An increase of 33 per cent in weight of this coupler, as compared with those now in use, is compensated for by an increase of 100 per cent in strength and 300 per cent in estimated minimum life.

It is not to be expected that defects will not develop in service which will need to be corrected. But the adoption of a standard coupler is an epoch-making step. As soon as this standard is brought into general use the carriers will be relieved of the enormous expense incident to supplying repair parts for the great number of different couplers now in use, and a much safer operating condition will be brought about by the use of one form of coupler with which every employee will be familiar. Yet the mere fact that its adoption has received a favorable vote may mean little unless those who have voted for it exert every effort to see that the coupler is actually put into use. Much time and money have been spent in developing the coupler and to demonstrate its advantages over others now in use. The obvious advantages of standardization of coupler equipment should lead to its immediate introduction and use.

With the more general adoption of uncoupling devices having rigid connection between uncoupling lever and lock block there has been a slight decline in the number of cars per thousand inspected with defective uncoupling mechanisms, this number having decreased from 5.10 to 4.17 during the past year.

Cases continue to be reported where cars are equipped with handholds less than 16 in. in clear length. The order permits the use of 14-in. handholds only where it is impos-

sible to apply those 16 in. in length. The extension of the handhold beyond the face of the car in order to provide the minimum clear length required is a practice that should be discontinued and cars on which handholds are so applied will be reported as defective by our inspectors.

A great many handholds, ladder treads and sill steps are being reported loose, the nuts on the bolts securing them to the cars not being properly riveted over.

A marked decrease is noted in the number of defects to air-brake equipment reported, which is indicative of the growing tendency toward 100 per cent efficiency of power brakes in trains. This result can not, however, be attained so long as only enough brakes are kept in operative condition to allow trains to go forward with the minimum of 85 per cent of the air brakes required by Law in operative condition. Much has already been said about the imperative need of greater care in the maintenance of air brakes, and much good has been accomplished, but there is still a great deal to be done before that efficiency of air brakes which is contemplated by the law is secured.

Proper maintenance of air brakes can only be had by the employment of competent men. In this connection it is encouraging to note that the carriers are educating their inspectors in the more efficient discharge of their duties and are securing men who have a better knowledge of air-brake systems. And in many instances, also, yards have been equipped with compressors and air lines for testing air-brake equipment and enabling proper repairs to be made.

It is clearly manifest that the intention of the Commission, as set forth in its order of June 6, 1910, was that all power-braked cars in trains should have their brakes used and operated from the locomotive drawing the train, and several suits have been instituted in order that this part of the law may be tested in the courts and its true intent defined.

A recent decision of the District Court of the United States for the Eastern District of Washington is of great importance, as it gives a comprehensive construction to the power-brake provision that the train shall be so equipped as to run without requiring the use of the hand brakes; it is held that this is a prohibition against the use of the hand brakes in the ordinary movement of trains, and the language of the act was equivalent to declaring that after the date named freight trains should not only be equipped to run, but should actually be run without requiring brakemen to use the hand brake.

The Circuit Court of Appeals, Third Circuit, has decided that the requirement of efficient air-brake equipment presupposes that such equipment shall be inspected at terminals.

The importance of terminal tests as an element of safety in railroad operation can not be overestimated. At many terminals the only air-brake test made consists merely in ascertaining whether or not the air is working throughout the train line. Such a test provides no adequate information as to the efficiency of individual brakes, and, as inspection has shown, trains are not infrequently permitted to leave terminals with insufficient braking power. In this connection a system of careful inspection and tests at terminals is strongly urged.

An important adjunct to the air-brake system that receives but slight, if any, attention by roads operating in level country, is the retaining valve. Since there is little or no need for them on these lines, the roads contend that they should not be expected to maintain them. The result is that on roads having heavy grades the work of repairing and maintaining retaining valves, as well as applying them when these devices are missing from the cars offered in interchange is unduly burdensome.

As was stated in last year's report, an air-brake gage in the caboose, together with a conductor's valve that is readily available in case of emergency, is important for the proper handling of long trains. Without this gage to indicate the

brake-pipe pressure the trainmen on the rear of the train are in ignorance of the air pressure available for use and have no means of knowing with certainty whether their trains have sufficient air in reserve properly to control them.

In addition to the increased attention being given the power brakes on cars, a decrease in the percentage of defective hand brakes is shown. This is due to the general improvement of safety appliance conditions occasioned by the better understanding of the standards than to any especially important event drawing attention to the necessity for hand-brake maintenance. Notwithstanding the increased efficiency of the air brake no less consideration should be given the hand brake, as it is just as necessary in controlling the speed of cars being set on sidings and while making up trains as the air brake is in controlling the speed of the train when made up. A hand-brake decision of importance defines the word "efficient," as used in the statute, as comprehending the efficiency of the hand brake for the purpose of holding a car or train, as well as its efficiency as a matter of safety to employees engaged in work requiring the use of hand brakes.

An important decision recently rendered by the District Court of the United States, Northern District of California, fixes the liability for the penalty provided by the safety appliance acts for their violation upon the common carriers "permitting" the use on their lines of equipment not in conformity with the requirements in such cases.

Much expense could be spared the carriers if some method of instruction in the proper manner of loading logs and lumber on flat cars were adopted, so as to prevent the loads from shifting and coming in contact with the brake shaft or wheel, causing the hand brake to become inoperative. The 4-in. clearance around the rim of brake wheel should be maintained as well between the rim of the wheel and the lading as between the rim of the wheel and parts of the car itself if the degree of safety contemplated by the law is to be provided, but cars are frequently loaded in such a manner that the hand brake is entirely obstructed.

Two decisions recently rendered by the Supreme Court of the United States construe the provisions of the safety appliance acts as applying to electrically operated railways as well as to steam railways, thus establishing that cars operated on such railways shall have the complement of handholds, sill steps, hand brakes, and other safety appliances required by the safety appliance law, and that trains operated over such lines shall have their speed controlled by power brakes.

ALL STEEL PASSENGER CARS FOR THE CHICAGO, BURLINGTON & QUINCY

The Chicago, Burlington & Quincy has recently received from the American Car & Foundry Company fifteen chair cars, fifteen coaches, nine combination baggage and smokers, and two combination coach and smokers, of all-steel construction. The specifications of these cars comply in detail with the government's specifications for steel cars, and in many cases exceed these requirements. The construction adheres very closely to that which was made standard on the Burlington a few years ago and which was described in the *Railway Age Gazette, Mechanical Edition*, of February, 1914, page 77. All of the new cars have vestibules, except the combination baggage and smokers, which have a vestibule on one end only, the other end being of the dummy type. The chair cars weigh 140,000 lb. and have a seating capacity of 64, which gives a dead weight per passenger of 2,190. The chairs are located on 3 ft. 7 in. centers. A space of 5 ft. on each end of these cars is given over to toilet facilities, one compartment containing the closet, the other the wash bowl with hot and cold water, a drinking fountain and mirror. The women's end contains in addition to this two seats with leather covered cushions.

The coaches weigh 141,000 lb. and have a seating capacity

of 84, giving a dead weight of 1,680 lb. per passenger. The seats are located on 2 ft. 11½ in. centers. A women's wash room and a closet occupies a space 4 ft. 6¼ in. long on one end of these cars and the men's closet and the wash room occupies a space of 3 ft. 4¼ in. on the other end. The combination coach and baggage cars weigh 137,000 lb. and have a seating capacity of 36. The length of the baggage section is 40 ft. ¼ in. and the coach section is 30 ft. ¼ in. long. This section is provided with a stove, a closet and cooler.

The cars are of the clerestory type, the upper deck windows having been omitted, and the only openings are those

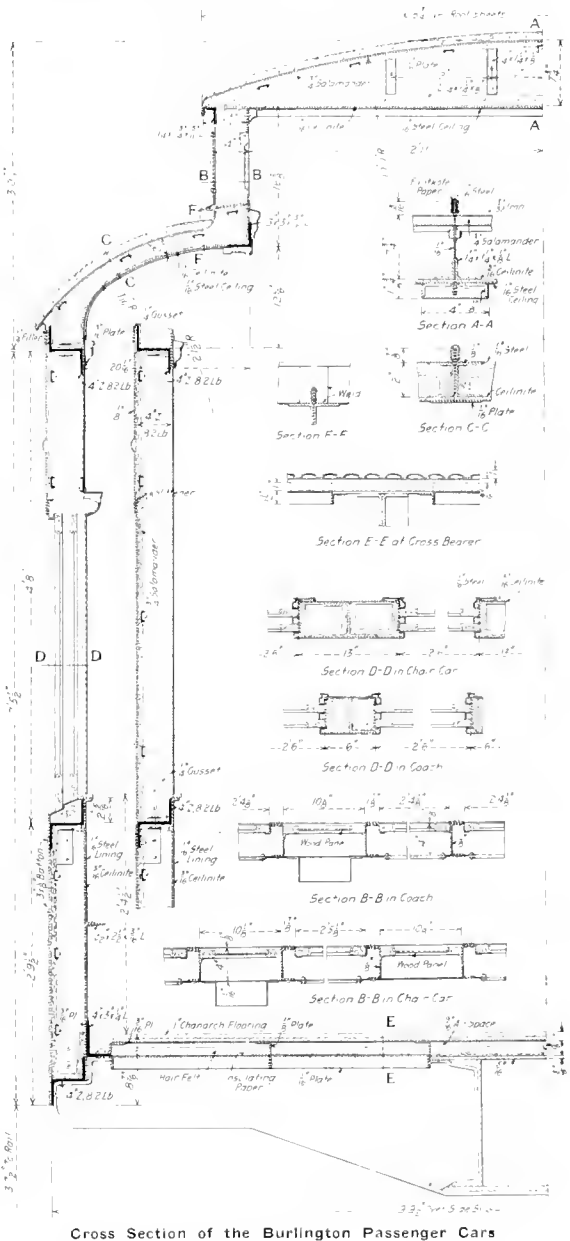

required for the ventilators. The side carrying type of construction is used, the sides being considered as being supported at the double body bolsters. This leaves the center sills to take care of the buffing and pulling strains only. These are designed for a maximum end shock of 400,000 lb. considered as a static load. The center sills are made up of

15-in., 33-lb. channels spaced 16 in. back to back with a 5/16-in. by 28-in. top coverplate extending from end sill to end sill, and a bottom coverplate 5 5/8 in. by 24 in. extending

the vestibule 3 1/2-in. by 3-in. by 5/16-in. angles. The side plates and side sills are 4-in., 8.2-lb. Z-bars.

A cross section of the cars taken through the window is

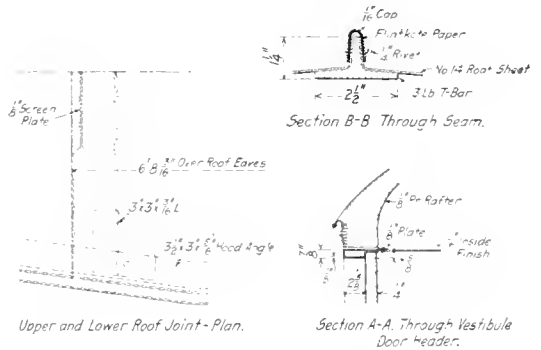
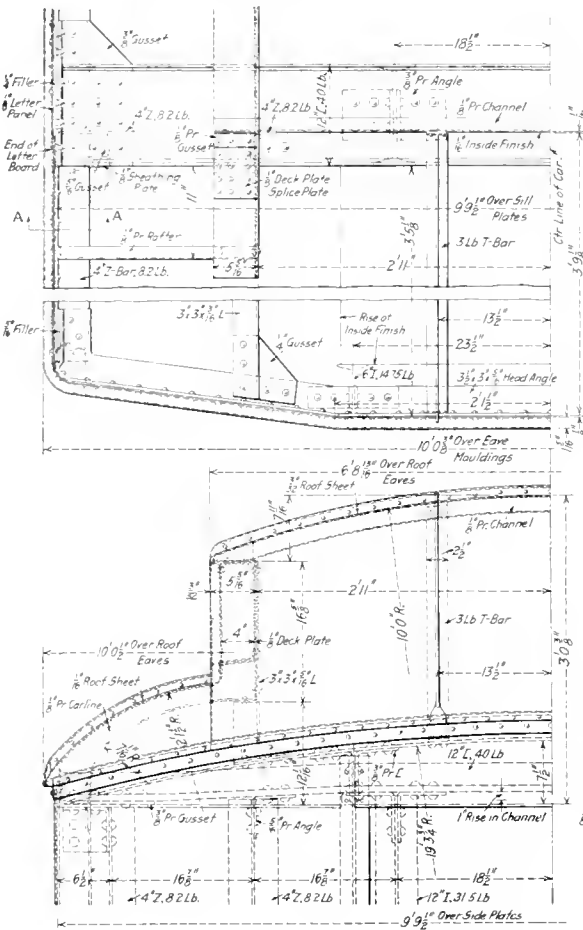

Vestibule Hood Construction—C. B. & Q. Steel Passenger Cars

between the draft castings. The bolsters and cross bearers are of built up construction, having pan shaped web plates with ample connections at the center and side sills. The end sills are made up of pressed steel shapes. The corner, side

shown in one of the illustrations. It is common to both the chair cars and the coaches, with the exception of sections B-B and D-D. Contrary to previous practices the Gothics and segment sash above the side windows have been omitted, mak-



All-Steel Passenger Cars for the Chicago, Burlington & Quincy

and intermediate end posts are 4-in., 8.2-lb. Z-bars. The door posts are 12-in., 31.5-lb. I-beams and the vestibule diaphragm posts are 6-in., 14.75-lb. I-beams. The end plates on the body of the cars are 12-in., 40-lb. channels and on

ing it possible to increase the height of the window glass 4 in., giving a clear glass opening 29 in. high. A larger amount of natural light is thus admitted to the cars than before. This arrangement has made a greater depth of letter board nec-

essary, it now being $21\frac{7}{8}$ in. deep. In order to improve the appearance of the car and also to stiffen this sheet a groove is pressed in the letter board $8\frac{1}{8}$ in. above the bottom. Another interesting feature to be found in the cross section is the manner of riveting the roof sheets. They are so applied that both rivet heads are on the outside of the car where they are readily accessible. This permits the roof sheets to be readily removed whenever desired.

The cars are insulated on the roofs, sides and ends with $\frac{3}{4}$ -in. 3-ply Salmander secured to the inside of the outside sheet, and $3/16$ -in. Ceilnite applied to the back of the inside sheet. The floor is built up of a $1/16$ -in. steel sub-floor on which is applied a layer of insulating paper, a 1-in. course of hair felt, a $9/16$ -in. air space and a No. 18 Toncan metal Chanarch flooring $\frac{1}{2}$ in. in depth which in turn is covered with Magnesite cement. Aisle strips of interlocking rubber tiling are used on the chair cars and coaches. This floor construction has proved to be an excellent insulator of sound.

These cars are lighted by 50 and 15-watt lamps. The coach has 10 of the 50-watt lamps in the middle of the car, as shown in the illustration. The fixtures are of the semi-indirect type, being furnished by the Adams & Westlake Company. In addition to this there are twelve 15-watt lamps located as follows: Two in each vestibule, two in the women's compartment, one in the men's closet compartment, one in



Interior of Burlington All-Steel Coach

men's washroom and one each side of the partition between the toilet compartment and the car. Five emergency candle fixtures are located on each side of the car, and two in each toilet compartment. The chair cars have eight of the 50-watt semi-indirect units, and twelve 15-watt units located substantially the same as in the coaches, and 12 emergency candle fixtures. The passenger ends of the combination cars are equipped with four 50-watt semi-indirect units, five 15-watt units, and four auxiliary candle fixtures. The baggage end is lighted by four 15-watt fixtures, and has four auxiliary candle fixtures. Three of the coaches are equipped with the axle generator system, the others being equipped with the head end system.

Six-wheel trucks of the Commonwealth Steel Company's design are used under all the cars. They are provided with the American Brake Company's clasp brake, and have 36-in.

rolled steel wheels. The following is a list of the general dimensions of the cars:

Length over sills	70 ft. 8 1/2 in.
Length over buffers	70 ft. 6 1/2 in.
Length inside	70 ft. 1/2 in.
Width inside of bumpers	9 ft. 1 1/2 in.
Width over side sills	9 ft. 9 1/2 in.
Width over eaves	10 ft. 1/2 in.

*For the combination cars this length is 74 ft. 9 1/2 in.

MAINTENANCE OF AIR BRAKES ON FREIGHT CARS*

BY H. S. WALTON

Supervisor of Air Brakes, Boston & Albany

Up to within a few years the importance of maintaining the brakes on freight cars did not seem to be fully realized, and the railroads seemed loath to spend the money to install the apparatus necessary for the proper testing of freight brakes at terminals. Formerly, the only test made was to see the brakes applied and released after the train was made up and the locomotive coupled on—then the train was hurried out of the yard.

Agitation by the air brake supervisors has resulted in many roads installing yard-testing plants, and the excellent results obtained have demonstrated that the investment has been a paying one. There is, however, room for improvement, as many roads are still without these testing plants.

A yard-testing plant is as necessary to the proper maintenance of air brakes as a locomotive is to the hauling of a train. The testing plant should consist of a compressor of sufficient capacity to charge the maximum number of cars in a reasonable time; a cooler for the air to pass through (to obviate condensation in the lines), a storage reservoir with a capacity equal to the volume required to charge the maximum number of cars; piping of such size and alignment as will permit of the unrestricted flow of air, and a portable testing truck or other device for operating the brakes. Air brake inspectors should be selected by the supervisors of air brakes, with a view to obtaining men of sufficient intelligence to become efficient in the performance of their duties; and the position should be made sufficiently attractive to induce men of such capacity to accept it.

TESTING TRAINS

The brake pipe and auxiliary reservoir should be charged to 70 lb. The inspector should then go over the train, cutting in all brakes found cut out, noting the condition of the foundation brakes and stopping all leaks in the hose couplings and pipe joints. The brakes should then be applied with a 20-lb. reduction of the brake pipe pressure. The brakes should again be looked over, and all cars marked, or carded, on which the brakes have not applied or on which the piston travel needs adjustment. The brakes should then be released and looked over to ascertain if all have released. Minor repairs should be made immediately and cars requiring heavy repairs carded for the repair track.

CLEANING TRIPLES

In cleaning a triple valve it should be dismantled, and all internal parts, except those with rubber seats and gaskets, cleaned with gasoline, then blown off with compressed air and wiped dry with a cloth. All worn or defective parts should be repaired or replaced, and special care should be taken to clean out all ports and passages. The seat and face of the slide valve and slide valve graduating valve, also upper portion of bushing where slide valve spring bears, and the triple valve piston and its cylinder should be lubricated with a high-grade lubricant. No lubricant should be applied to the emergency piston, emergency valve or check valve. All triple valves, after being cleaned, should be tested on a rack

*From an address before the January meeting of the New England Railroad Club.

conforming to the M. C. B. standards. In cleaning brake cylinders all deposits of gum and dirt should be removed with a putty knife, and the piston and interior of the cylinder cleaned with waste saturated with kerosene. All rust spots should be removed.

Particular attention should be given to cleaning the leakage groove and auxiliary reservoir tube. Cracked or worn packing leathers should be replaced by new ones. The expanding ring should be removed from the piston, and replaced by a ring of the proper dimension, the old ring to be sent to the shops to be gaged and adjusted to the proper size.

The inside of the cylinder, and both sides of the packing leather should be lightly coated with a suitable lubricant.

The brake cylinder should be tested for leakage after cleaning, preferably with a gage, and leakage should not exceed 5 lb. per minute from an initial pressure of 50 lb. Each time the triple valve and brake cylinder are cleaned, the brake pipe, brake pipe strainer, and branch pipe should be blown out, and the triple valve strainer cleaned before re-connecting the branch pipe to the triple valve. If a dirt collector is used, the plug should be removed and the dirt blown out.

The restricted exhaust port in the retaining valve should be cleaned each time the triple valve is cleaned, and the valve and pipe connecting it to the triple valve should be tested. Special care should be taken to have all pipe clamps tight. It should be seen that there are no worn, defective or missing parts of the foundation brake, and in replacing such parts care should be taken to have them of the proper dimensions.

Thus far we have made a simple statement of what we believe to be necessary to maintain the brake, but this paper would be incomplete without a statement as to some of the penalties for neglect.

PENALTIES FOR NEGLECT

Brake Pipe Leakage.—This is a menace to the safe and successful handling of trains, because it is almost impossible for an engineer, be he ever so skillful, to do proper and safe braking, especially in descending grades. If he makes sufficient reduction to insure the application of the brakes, with a view to regulating the speed of the train, it is possible that he will, in order to avoid stopping, have to release the brakes at a time when such a course would be inadvisable and possibly dangerous, for it may be at a point where signals, though not far distant, are not visible. Then again, brake pipe leakage is conducive to stuck brakes, flat wheels, and undue quick action, which often results in damage to draft gear and lading.

Furthermore, brake pipe leakage is very expensive when we consider the wear and tear of the pump and the additional consumption of fuel. Let us consider the latter in connection with a 70-car train assumed to have one-half 8-in. and one-half 10-in. equipment. A leakage of 5 lb. per minute on this train, with a 70-lb. train pipe pressure would amount to 39.5 cu. ft. of free air per minute, or 23,700 cu. ft. of free air in ten hours. The 8½-in. cross compound pump, driven with 200-lb. steam pressure would require three hours and five minutes to compress the air lost, and in doing that amount of work 5,782 lb. of water would be evaporated; and assuming that 8.5 lb. of water is evaporated with one pound of coal 680 lb. of coal would be consumed.

The New York No. 5 pump would require three hours and twenty minutes to do the same amount of work and would use 10,475 lb. of water and 1,230 lb. of coal. For the 9½-in. pump this work would require nine hours and eleven minutes with 15,144 lb. of water and 1,780 lb. of coal.

Triple Valve.—Many cases of slid flat wheels may be traced to a worn triple valve piston packing ring or bushing, and undue quick action is invariably the result of a broken carrying pin, weak graduating spring or obstructed service graduating ports.

Brake Cylinder.—The result of brake cylinder leakage is

the reduction or entire loss of braking power on the car and it necessarily follows that it will require a greater distance in which to stop the train as the work will have to be performed by the brakes of the other cars. Brake cylinder leakage also contributes to shocks, as the cars with effective brakes will be retarded more quickly than those with ineffective brakes.

Piston Travel.—Variation of piston travel makes a difference in brake cylinder pressure which often causes an unequal distribution of braking power in a train. For example, with a 10-lb. reduction of the brake pipe pressure a 6-in. travel gives 33 lb. brake cylinder pressure; an 8-in. travel 23 lb., and a 10-in. travel 16 lb.

On a railroad within a thousand miles of Boston there were 1,161 drawbar failures during the year ending June 30, 1916, and while there is no available data to show what per cent of these failures could be properly charged to defective brakes, the number would have been much less had there been a greater uniformity of piston travel and less brake cylinder leakage.

Foundation Rigging.—The average repair man pays scant attention to the foundation brake rigging, for if he finds the required number of rods and levers he does not concern himself as to their condition. In case of a broken or missing lever he, in the absence of a duplicate, often uses any lever that may be in stock, and should these levers be of wrong dimensions it will increase or decrease the braking power to such an extent that it may lead to serious consequences, such as slid flat wheels, shocks, etc.

Pressure Retaining Valves.—The pressure-retaining valve is not a necessity on level roads, but becomes an important feature on roads having heavy grades. These valves, when in operation, retard the flow of air from the brake cylinder in releasing the brakes to such an extent that the escape of pressure down to the closing of the valve is about six or seven times as long as it would be if the retainer were not in use. Furthermore, a certain amount of pressure is retained in the brake cylinder, and on subsequent applications of the brakes, the brake cylinder pressure builds up from the retained pressure instead of from atmospheric pressure, with the result that we can, by using these valves, control a train down a grade with about one-fourth to one-third the volume of air that would be required without their use. The proper maintenance of the pressure retaining valves will not only enable us to control our train more safely on descending a grade, but will effect a considerable saving in fuel.

THE CONDUCTOR'S RELATION TO THE OILER*

BY M. GLENN, Sr.
Ludlow, Ky.

A train of freight cars leaves a terminal with the oil boxes well oiled and packed, and the brasses all O. K. The train is in charge of the conductor, who should make a report of the hot boxes on his train on arrival at the terminal. The oiler, who must be an expert, must examine the hot boxes reported to him, and make a report of his examination and work on them and forward it with the conductor's report attached, to his foreman. This will prevent a great number of cars with hot boxes from being switched on side tracks for unloading and then getting back into service when empty.

The oiler will also recognize the hot boxes on the arrival of trains at terminals much more easily than he will defective boxes on trains leaving the terminals.

*This article was entered in the Hot Box competition which closed October 1, 1916.

EXPANSION OF ZINC.—Of all common metals zinc expands and contracts the most for any increase or decrease of temperature; hence it is sometimes particularly valuable where expansion and contraction with variations of temperature are desirable.—*Railway and Locomotive Engineering.*

Shop Practice

FORMING KNUCKLE PIN NUTS UNDER THE STEAM HAMMER

BY H. C. GILLESPIE

The tool shown in the drawing is a die designed for punching knuckle pin nuts out of flat bars, which is in use in the Peru, Ind., shops of the C. & O. It is used in connection with a steam hammer. The material for the nuts is either bought of the proper thickness, and slightly wider than the nuts, or it is forged in the blacksmith shop.

The bars are heated in an oil furnace and are then inserted

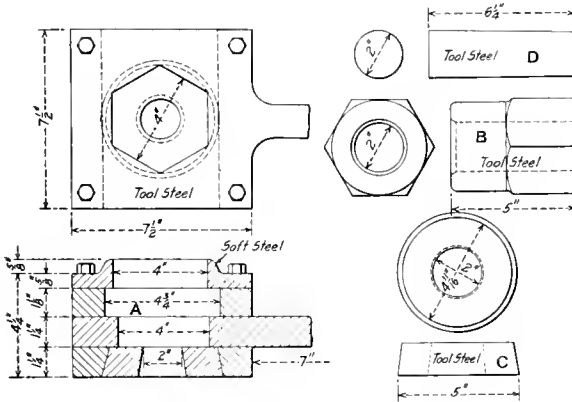

Die for Forming Knuckle Pin Nuts

in the slot A. The hexagon punch B is placed in the die and struck with the steam hammer. This forces the blank down against the die C. The round punch D is then placed in the hole in the hexagon punch B, and struck with the hammer. This completes the forging, which is finished on a drill press equipped with a tapping attachment. By the use of this die it is possible to turn out knuckle pin nuts at the rate of one a minute.

MACHINING SHOES AND WEDGES

By the use of a slab milling machine and the Morton draw cut shaper shoes and wedges are machined ready for application, in $13\frac{1}{2}$ minutes at the Dale street shops, St. Paul, of the Great Northern. The illustrations show the methods followed for preparing the shoes and wedges on the slab milling machine. The photograph shows a shoe set up ready for milling, and the drawing gives the details of the chuck which holds the shoe. On the milling machine all surfaces, except the face, are machined with one cut. The shoes and wedges are then placed in stock to be used as required. The milling machine work takes $6\frac{1}{2}$ minutes per shoe or wedge, and the shaper operation takes 7 minutes. As the shoes are required they are taken to the engine and "pop" marked for finishing.

The chuck on the milling machine consists of the base A, which is clamped in a frame, as shown in the photograph.

This base is provided with a T-slot, in which slides the binding jaw B. It is controlled by a square threaded lead screw C, which meshes with B on its upper half and with A on the lower half. The jaw B is made of cast iron and is

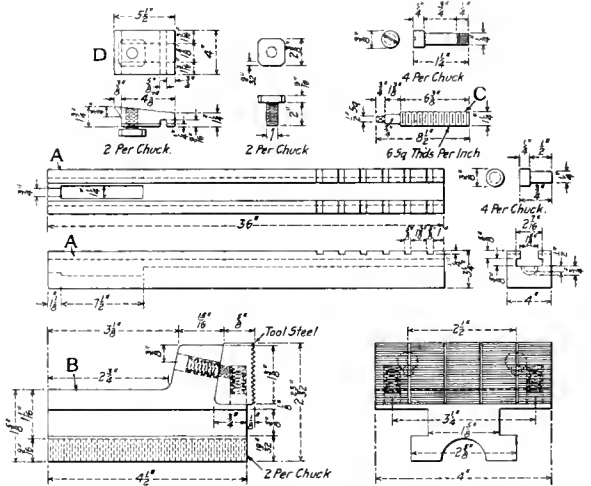

Chuck for Milling Shoes and Wedges

provided with a tool-steel face which fits into the jaw on an angle, and which is held in position by springs, as indicated in the drawing. This construction insures a pulling down grip as the binding jaw is forced onto the work, thus keeping it firmly on the bed of the chuck. The back rest is

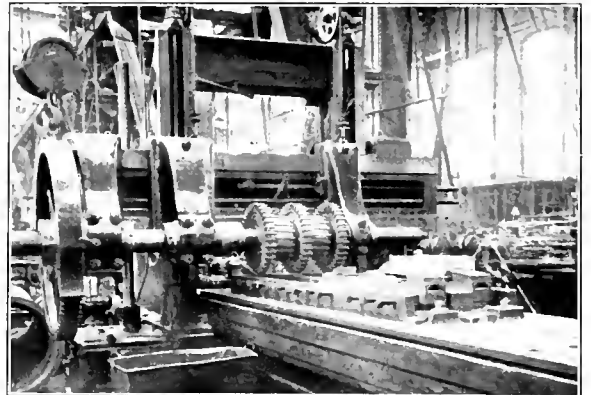

Method of Machining Shoes and Wedges on a Slab Milling Machine

shown at D. It is provided with a T-bolt which slides in the T-slot of the base and it is held in position by means of a key which fits in a keyway in the back rest and in the chuck base. Several keyways are provided in the base A to accommodate the various lengths of shoes. With the arrangement

shown several shoes or wedges can be milled at the same time. The shoes are allowed to lay flat on the chucks while the wedges are raised at one end to give the proper taper.

APPLIANCES FOR TESTING FREIGHT CAR BRAKES IN YARDS

BY M. K.

To furnish a simple means of testing triple valves without removing them from the car, the apparatus shown below has been developed. It is designed for use on freight cars and has proved to be a great convenience in yards. The principal parts of the device are a 3 1/2-in. inspector's test gage, a 1/2-in. cut out cock and two special cocks, the construction of which will be described in detail. The device as assembled is arranged to be connected to the air hose on the car and the 1-in. air hose leading to the compressed air line.

The variable leakage valve, No. 3, is shown in detail in the drawing. It is arranged to discharge air through three orifices of different sizes, the center of the plug being drilled out with a 3/16-in. drill and having three holes of 9/64-in., 5/64-in. and 1/32-in. diameter, respectively, through the walls of the plug. The positions of the plug when each of the orifices is open is indicated by a pointer and numbers on the body of the valve. In the normal position of the valve, the handle is along the body and the orifices are closed.

The valve, No. 2, which forms a by-pass around the stop cock, No. 1, is a standard 1/4-in. drain cock which has a bushing with a 3/64-in. hole in the union tailpiece. The device is coupled to the hose on the car and to the compressed

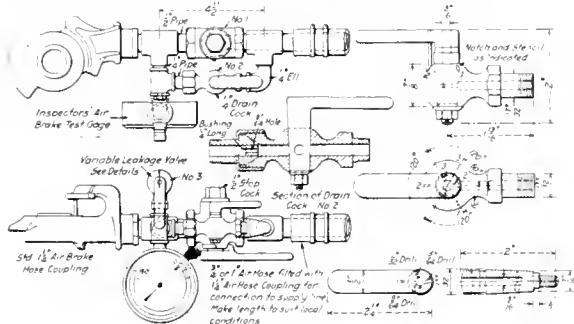

Device for Testing Triple Valves Without Removing from Cars

air line, a dummy coupling being placed on the hose on the opposite end of the car. Then the cock No. 1 is opened and Nos. 2 and 3 are closed, the hose and all pipes being examined for leaks. After all leaks have been stopped, the cock No. 1 is closed and the variable leakage valve is placed in Position No. 1 (9/64-in. opening). At this rate of reduction of brake pipe pressure the brake must apply in quick action. The variable leakage valve, No. 3, is then closed and cock No. 1 opened until both the brake pipe and the auxiliary reservoir are charged to 70 lb., then the cock No. 1 is closed and the variable leakage valve placed in position No. 2. If the triple valve applies in quick action in this position, it must be removed, cleaned and tested on the test rack.

Valve No. 3 is then closed and stop cock No. 1 opened until the brake pipe and auxiliary reservoirs are again charged to 70 lb. The retaining valve handle is turned up and cock No. 1 closed and the variable leakage valve placed in position No. 3 until the brake pipe pressure has been reduced 15 lb. If the brakes fail to apply, examination must be made to determine the cause. If the brakes apply, cock No. 1 is opened and if the brakes then fail to release, the triple valve must be removed and proper repairs made.

ROLLER TOOL FOR FINISHING PISTON RODS

BY A. J. HUMPHREY

A roller tool for finishing piston rods which does not have the objectionable features of the usual type with but one roller is shown below. In order that the rod may be rolled close up to the piston head, the tool is made in two sections. One section carries the rollers, of which there are three, two behind the rod and one in front of it. The roller

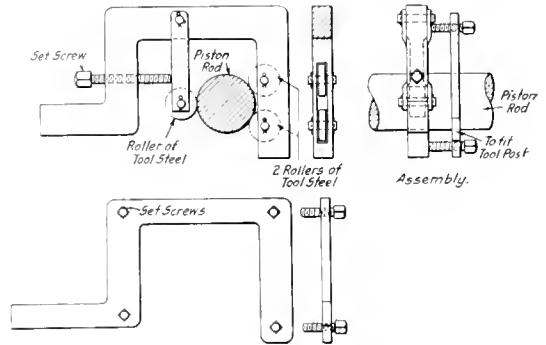

Details of the Piston Rod Roller Tool

in front of the rod is on an arm which is free to swing, and pressure is applied to this roller by a set screw bearing against the arm. The construction of this feature resembles that of a hand-operated pipe cutter.

The other section is clamped in the tool post and feeds the roller section by means of set screws pressing against it.

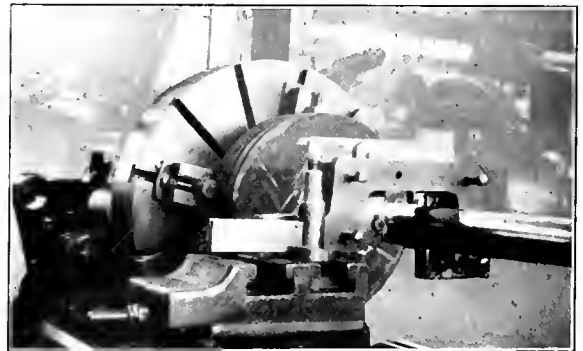

The Roller Tool in Operation

By adjusting these set screws, the rollers can be set so that they will not roll ridges on the rod. With this tool there is no tendency to spring the rod, even though considerable pressure is used and the work may be run at a high rate of speed without heating the dead center.

MACHINE TOOL EXPORTS.—The machine tool exports from America during the year ending June 30, 1916, are said to have exceeded \$61,000,000, of which about \$48,000,000 left through the port of New York. This is more than twice the amount of similar exports for the previous year.

LOOK BEFORE YOU JUMP.—Upon taking charge of a new plant, do not begin by making promiscuous adjustments. It is better to wait a day or two until the apparatus is thoroughly understood, and then changes should be made only after the object to be attained is definitely known.—Power.

APPLYING LOCOMOTIVE BOILER TUBES*

Outline of Shop Methods for Handling and Renewing Boiler Tubes and Welding Them in the Tube Sheet

BY R. B. VAN WORMER

General Foreman, Atlantic Coast Lines, Waycross, Ga.

IN presenting this paper on the subject of handling and applying locomotive tubes, it is not the intention to attempt to lay down or describe a method of tube handling ideal in all details and applicable to any or all locations. The most desirable procedure as a whole for a given point should embody and provide for numerous details characteristic to that location, including requirements from dependent outlying points, average life of the tubes as compared with the machinery, variety in the size and length of the tubes required, labor conditions and rates, oil or coal fuel, etc. Not only shop methods and different materials used, but operating conditions, tonnage ratings, grade percentages, etc., prevailing on different roads or districts all have their influence affecting the tube situation, service and economy that may be obtained, and indirectly the best shop practice to follow.

It is safe to say no other item on a railroad presents greater possibilities for improved economy than the tube problem on a road where the subject has not been handled with considerable thought and preparation. It might also be safe to say there is no other item on a good many roads which has received less study and special consideration. To get down to a working basis the total number of tubes there are in continual service should be determined, together with the percentage of new tubes purchased, the percentage that must be scrapped on account of pitting, corrosion or thinness, the proportional cost of any water treatment used as compared to the saving in the tubes affected, the mileage obtained between safe-ending, shop and engine house costs for removing and replacing tubes in boilers, shop costs for safe-ending tubes, and engine house costs for working over tubes in service.

New Tubes Purchased.—Large savings can be made by keeping the number of new tubes purchased each year down to a minimum. In considering this item it is only fair to include as new tubes, those contained in any new power purchased during the year. Consider 500 engines averaging 280 tubes each or a total of 140,000 tubes in service, a reduction from 6 to only 5 per cent of this total in new tubes purchased would mean a saving of approximately \$3,000 per year in material. Under what might be considered average water and road conditions, it has been demonstrated as possible to reduce the yearly purchase of new tubes to as low a figure as 5 per cent of the total tubes in service. The new tubes should always be ordered for the largest engines and those which carry the highest pressure. After they have been used in this service they can be used in the next size of engine where the length and the steam pressure are somewhat less, and so on down step by step until they are utilized in the smallest and lowest pressure engines available. They may perhaps even then be used in part for stationary pump boilers, before being consigned to fence railings, material for making washers, or scrapped, proper credit in any case being allowed.

Method of Handling Tube Work.—The expense of working the tubes has been greatly reduced by the practice of welding them to the back tube sheet when they are installed. The tube work for engine houses or small outlying points should include only the removing and the resetting in the

boiler. The tubes should be cleaned, safe-ended, swedged, and cut to length where possible, in the general repair shop. New tubes should be ordered only by the general repair shop, where all records and the best facilities for preparing them may be maintained. Where the tube work for the entire road is done at the main shop the tube department assumes a position of large importance. It should be carefully organized and a well defined plan of operation should be established. Where the life of the tubes between safe-ending averages from 40,000 and 50,000 miles and the mileage between general shoppings is 80,000 miles, it will be apparent that the service of the tubes will not keep pace with that of the machinery. This condition is generally met by renewing the entire set of tubes when the engine undergoes general heavy repairs in the back shop (including internal inspection), and again renewing the bottom half of the set during engine house repairs after the engine has completed half of its mileage. The engine house or outlying repair point should ship the tubes so removed to the general repair shop to be cleaned, safe-ended, cut to length and returned in quantities equivalent to two full sets. These figures, of course, will vary somewhat under different conditions, but the idea is to make the time for the installation of the full set of tubes come during the period of general repairs, to localize all tube work in a tube department at the general repair shop, and at the same time reduce to a minimum the tube work at all other points.

In districts where good water is available the tubes should run the three-year limit or more. The practice of welding the tubes to the back tube sheet has also materially reduced roundhouse work to tubes while in service. The average tube mileage under these conditions will keep pace with the machinery mileage. If during general repairs careful examination shows that three-year-old tubes will be serviceable for as much as 20,000 miles or more by only being worked over, request for government time extension will be justified all things considered, due consideration, of course, being given to the class of service to which that particular engine belongs, and its accessibility for repairs on the district to which assigned. If the various federal inspections and reports were made on a mileage basis rather than a time basis, there is no doubt that the time of boiler repairs could be thrown even more in harmony with the proper time for machinery repairs.

SHOP PRACTICE FOR GENERAL RENEWAL

When an engine has made its mileage it is sent to the general repair shop, with a report from the division on which it operated, giving the general shop information concerning any unusual condition of the engine. Assume that the locomotive under consideration in a saturated engine with boiler containing 336 two-inch tubes and a large quantity of scale; that an internal inspection is due; that the steam pipes and dry pipe are in good condition and tight, and that all other repairs are of such nature as to make the time for renewing the tubes a measure of the time the engine is out of service. The engine having arrived at the shop, the tank is cut loose; the contents of the boiler discharged through the blow-off cocks, and the engine backed onto its designated pit in the erecting shop. Each pit is provided with crane service from overhead, and pipe connections below, leading directly into the pit at convenient locations, for hot and cold water,

*Taken from a paper presented before the Southern & Southwestern Railway Club.

compressed air, acetylene gas, terminals for electric welding and terminals for electric lighting. Proper and reliable illumination is a necessity for economical tube setting, as well as other interior boiler repairs. The extension cord for lights should be of any good grade of packing-house cord which is water-proof and eliminates short-circuits and time killing light failures.

First Operations.—Considering the fact that the practice of welding tubes to the back tube sheets adds from one to two days to the time required for setting the tubes without welding, and also that internal inspection may develop certain boiler repairs that had not been contemplated or provided for in the shop schedule, it is essential that the tubes be removed from the boiler just as soon as possible after the engine is placed in the shop. With this in view, the front end is opened first and the spark arresting arrangement removed, all parts being wired together and tagged. The dome cap and exhaust stand are then removed by a machinist and the steam pipes are tested to determine definitely if they should come out. At the same time a boilermaker enters the firebox and cuts off the tube beads with a thin flat chisel and a No. 3 chipping hammer. Ordinarily this operation should require about four hours for a set of 336 tubes with the beads welded to the sheet. When the steam pipes are not removed the smoke box front should not be removed.

Removing the Tubes.—The same boiler maker with one helper then cuts off the tubes just inside the front tube sheet, using a tube cutting-off machine propelled by air. In cutting off the tubes with this machine, the helper operates the air motor, while the boiler maker applies and removes the cutter heads. Two cutters are used, one to be removed, applied and started by hand, while the other is cutting by power. In case the steam pipes are not removed, all the tubes with possible exception of three or four in each top corner can be cut off by shifting the machine and supporting bar to the right and left over the door studs. When all tubes are cut off, the fourth tube hole from the top in the center row is reamed out to not over $2\frac{1}{4}$ in. in diameter, preferably $2\frac{3}{8}$ in., depending upon the amount of scale on the tube. Through this hole the tubes are passed out of the boiler. The cutting of the tubes and preparing the transfer hole should require not over five hours. When the steam and dry pipes are removed the transfer hole is, of course, not needed, the tubes being passed out through dry pipe hole. The same boiler maker now returns to the firebox end and drives the tubes out of the back tube sheet with a No. 3 air hammer. At this time he has two helpers, one of whom enters the boiler through the dome to pass the tubes out through the transfer hole, while the other helper, in smoke-box, takes the tubes and loads them onto a specially arranged tube car. Not over five hours should be consumed by the one boiler maker and the two helpers for this work. The tube car is placed on a portable stand in front of the smoke box so that the tubes may be easily loaded and that the work will not require the services of more than one man. This arrangement was described in detail in the July, 1912, issue of the American Engineer on page 357. The tube car is designed to be carried by an overhead crane, or pushed along on its own four wheels on standard gage track. It can also be tiered on top of another car, thus greatly economizing in space at storage track. Another important feature in its design is that it can be quickly unloaded either on the floor or on elevated rail benches by raising one side with the crane, allowing the contents to roll out gently. All the tubes now being removed from the boiler, the helper in the front end pilots the car to tube shop. The helper inside the boiler remains and scales the shell, using a No. 1 pneumatic stone hammer equipped with wide, flat chisel. This work will take on an average of 4 or 5 hours, according to the condition of the boiler.

New Tube Lengths.—The boiler maker again returns to

the front end and knocks out the rag ends from front tube sheet with a No. 3 air hammer. He also trues up the tube sheets if necessary and reams out any tube holes found $1/32$ in. or over out of round with a special reamer and air motor. It should not require over one hour to knock out the stub ends from front sheet, and it is an exceptionally bad sheet that cannot be trued up in one hour by one boiler maker and helper. The tube lengths are then obtained with the assistance of the helper inside of the boiler. The new tubes should be $7/16$ in. longer than the distance over the tube sheets, $3/16$ in. of this to be at the firebox end and $1/4$ in. at smoke box end. From one to four different lengths are taken, a special wood stick with a hook at the end being provided for this purpose. The different lengths are numbered on the stick together with the engine number. The boiler maker also marks on the smoke-box the number of the tubes with their respective lengths and checks off on the tube sheet the areas covered by the different lengths. He personally delivers the dimension stick with any necessary explanation to the man operating the cutting-off machine in tube shop. The stick is retained here until after the tubes are reset, and serves as a check to place the responsibility if any tubes are found cut to the improper length. It is most important to have some simple but ironclad practice for obtaining the correct length of the tubes, as otherwise it will interfere with the plan of operation and cause delay.

Preparing the Tube Sheets.—The boiler maker then cleans out any scale in the back tube sheet holes, using a file. In extreme cases a very light application of the roller expanders will crack and shell out the thin and extremely hard scale sometimes found. The holes in a new back tube sheet should be made $1/64$ in. smaller than the nominal outside diameter of the tube and both inside and outside edges of the hole should be countersunk sufficiently to remove the sharp edges, but not more than $1/32$ in. The holes in new or part new front tube sheets should be made $1/32$ in. larger than the nominal diameter of the tube, and they should be similarly countersunk. The copper ferrules are then applied to the back tube sheet. Their outside diameter should be such that the ferrules will fit the hole tightly and they should be set in an exact position by a straight sectional expander having a small shoulder which seats against the face of the sheet so that the ferrule will extend $1/32$ in. out from the face of the tube sheet. In some localities it is the practice to set the ferrules with a special tool before expanding it into the hole with the sectional expander, but this is an unnecessary operation. When expanding copper ferrules with the standard ferrule expander, a hammer not larger than a chipping or No. 3 size should be used. The copper ferrule is set back $1/32$ in. to prevent working the ferrule out under the bead when working the tube, and particularly to prevent inferior welds when welding the beads to the tube sheet. The ferrules should be $5/8$ in. long for tube sheets $1/2$ in. thick, and of a size to suit the size of the tube hole, always maintaining the swaged end of the tube to $1\frac{1}{8}$ in. outside diameter. They should be of the best soft annealed seamless copper. To clean and prepare the holes for the ferrules, and apply and secure them, should not require more than four hours with one man.

Placing the Tubes.—In applying the tubes to the boiler, the boiler maker is, at first, given two helpers, one of whom is on the car containing the safe-end tubes and passes them to the boiler maker in the smoke-box. The other helper is inside of the boiler. When the steam pipes are not removed, the tubes going back of the steam pipes are first entered and placed by the inside helper in their respective holes, care being taken not to damage the copper ferrules. All tubes back of the steam pipes and several horizontal rows at the bottom are thus located and started in their ferrules, until there is no room left for the helper inside. He then goes to the smoke-box, and the boiler maker goes to the firebox.

The balance of the tubes, commencing at the bottom, are now shoved through their own holes by the two helpers at the front end, while the boiler maker enters them in their respective ferrules by means of an iron rod.

When all the tubes are in place, the second helper leaves the work, taking the empty tube car with him. The remaining helper assists the boiler maker to spot the tubes, using a bar with a shoulder to drive against at the front end and a gage at the back end to accurately locate the end of tubes $3/16$ in. from the firebox face of the sheet. New tubes are only added to those sets which are applied to boilers that have not had the steam pipes removed. These new tubes being in perfect condition should always be installed in the most inaccessible locations such as behind the steam pipes so as to reduce to a minimum inconvenient removals in case of failure during hydrostatic test or later. As each tube is accurately set $3/16$ in. from the tube sheet, the edge of the projecting tube at just one point is slightly turned over by one or two light blows with a special hammer, the striking face of which is something similar to a narrow fuller. This ensures no movement of the tube when starting the expander, and it requires no one at the front end to back up the tube. Accurately locating all tubes in the boiler, including those transferred ready for expanding, requires four hours upon the part of the boiler maker and two helpers.

Fixing the Tubes in the Tube Sheets.—The tubes are now ready for tightening in the sheets. The helper is removed from the work, the boiler maker being given the assistance of another man, usually an apprentice. The tubes are first expanded with a straight sectional expander in connection with a long stroke hammer. One man operates the air hammer without it leaving his hands, while the other manipulates the expander and mandrel. The expander pin or mandrel should be driven into the straight expander until the tube is solid against the ferrule and the sheet. The tubes are then run over with a standard flaring tool used in connection with a long stroke hammer, the ends being flared enough to allow the standard sectional prosser expander to enter sufficiently to get the prosser fillet just inside the water side of tube sheet. This also bells the tube sufficiently to start the bead with the beading tool after it has been prossered.

The tubes are prossered with the standard sectional expander, the pin of which is driven in tight, slacked off, and the expander turned slightly in the tube and driven in again. This should be done at least three times, or until the tube is properly set. All tubes should be carefully inspected to ensure that the recess in each tube has reached the full depth of the boss on the expander and is even all around the tube. When tightening the tubes to the back sheet no oil should be used if they are to be welded, for electric welding is decidedly unsuccessful if oil or even traces of oil is on the work. An oil soft soap, such as linseed soap, should be used as a lubricant, the remaining traces of which are much more easily removed than oil. To expand, flare and prosser the full set of tubes with the long stroke hammer should require not over eight hours' time for the boiler maker and apprentice.

The tubes at the front end are expanded with the standard front end flaring tool, consisting simply of a tapered pin. Not over thirty minutes is required for this operation, after which the boiler maker returns to firebox, beads the tubes and prepares them for welding, leaving the apprentice and a helper in front end to roll the tubes with an air motor. In performing these operations at both ends at the same time, the beading follows the rolling of each tube.

After beading the tubes with the standard beading tool, the operation is repeated with a roughing tool which prepares the bead and sheet for electric welding. This roughing tool is very similar to the standard beading tool, differing only in the design of the heel, which is slightly larger, having its face corrugated by the impression of a coarse file when hot.

This operation removes any possible remaining trace of scale or foreign matter on the metals to be welded, as well as presenting a suitable surface for the metal to knit to. This process of brightening or roughing requires about one hour's time.

In rolling the tubes at the front end, a standard self feeding rolling expander is used, the helper operating the air motor. It is sometimes necessary to shim a few tubes at the front end. This is done with unplished sheet iron peaned down to a feather edge. The rolling of all tubes at the front end averages about 5 hours, whereas beading and roughing requires 6 to $6\frac{1}{2}$ hours; the difference in time of the two operations is consumed by the apprentice in applying the arch tubes and mud plugs in readiness for hydrostatic test.

Hydrostatic Test.—The hydrostatic test is then applied, using water of a sufficiently high temperature to cause any leak to quickly dry on the sheets or shell when they are caulked or otherwise closed up. During this test the tube setters inspect the tubes. The defective tubes, if any, are then removed by splitting, not over 2 in. at the front end and backing out. Ordinarily the amount of defective tubes so removed should not average over one per cent, and being located out toward the center of the boiler where they are easily and readily removed through their own holes, as previously explained, they can be replaced much quicker and cheaper than by testing each tube individually before it is installed in the boiler. The defective tubes removed are smashed over all welds with a hammer to prevent any possibility of a defect in one of the two or three old welds being overlooked and again finding its way back into another boiler. These defective tubes are at once carried to the flue shop by the boiler maker and helper, who obtain an equal number of new tubes without safe ends which, when installed, require no further testing.

WELDING TUBES TO BACK TUBE SHEET

The installation of tubes to boiler is now complete with the exception of the last and final operation of welding the beads to the back tube sheet. This welding can be best accomplished by one of the regularly assigned tube welders of the shop. The work requires continual care and thoroughness rather than great skill. Where a number of welders are employed, the best operator should be the chief welder and his duties should include supervising the welding work as well as instructing or breaking in new welders. He should see that the work is properly prepared for welding, which is most important for good work. When possible it is excellent practice in the back shop to have the chief boiler inspector also be the chief welder, since with this combination all welding is thoroughly inspected from the standpoint of both durability and federal regulations, and tends to discourage any welding which might be considered impracticable or expensive. Welding fifteen 2-in. tubes per hour is a fair average for thorough work for one man. While no hard and fast rules may be laid down as to the size of the electric welding outfit, it may be said that for miscellaneous repair work around general repair shops of about 24 pits, a 600-ampere equipment, which is of sufficient capacity to take care of four operators on metal electrode work, is usually satisfactory.

Cost of Welding Beads.—For tube welding $\frac{1}{8}$ -in. welding wire of the best Norway or Swedish iron gives the best results. With this material the current runs from 110 to 130 amperes per operator. With 80 per cent efficiency in the motor generator set and on a basis of 15 tubes per hour this would mean an average current consumption of 665 watts per 2-in. tube. Assuming the power to cost 1 cent per kw. hr. the cost for power would be 0.7 cents per 2-in. tube. A good welder will average 18 tubes per pound of $\frac{1}{8}$ -in. welding rods, which at 8 cents per pound, and the welder's time

at 43½ cents per hour gives a total labor, material and power cost of 4 cents per 2-in. tube.

Flux.—Opinion seems to be equally divided with reference to the use of a flux in connection with tube welding. A series of tests made with and without the use of flux developed no difference in results, but particular care was taken to see that the sheet was absolutely clean. In the case of welding systems where a carbon electrode is used to form the arc, the flux is an important item as it removes, by combination, any carbon carried over from the carbon electrode. However, this does not apply in the case of metal pencil electrodes, where theoretically at least no flux is necessary. Where a flux is used, it is applied most conveniently by making a paste by the addition of a small amount of water to the flux finely powdered, and in which the electrodes are dipped and then allowed to dry.

Welding Operation.—The electric welder first runs over the tubes with an acetylene torch just sufficiently to burn off any trace of the linseed soap lubricant of foreign matter which may possibly have collected there. This does not require over 20 minutes time. If at any time the sheets get wet, they must be dried or inferior welding will result. Each tube as welded is also again brightened by means of a stiff wire brush to remove any possible trace of rust or red oxide which so quickly collects on the surface of the new metal from the hot water during the hydrostatic test. Care should be taken that the voltage is not too high. High voltage makes it easier for the operator, but it is not good for the tubes, as the operator with high voltage keeps the metal pencil ½ to 5⁄8 in. from the sheet, and the metal only sticks and does not weld. A voltage of 65, with 125 amperes, makes the operator get within 3⁄16 in. from the sheet, which is the correct distance for most efficient welding.

When welding the tubes, it is desirable to start with the top horizontal row and weld across row after row. This protects the unwelded tubes from the effects of the fumes and gas which escape from the arc. The weld of each individual tube should be started at the bottom, building on upon each side of its circumference to the top. If it is desirable to particularly rush the work of welding, two operators can be used on the tube sheet and wall panel, partitioning them off from each other by means of a canvas curtain suspended from a rod inserted in one of the top tubes. After the tubes are welded, it is unnecessary to go over and smooth up the beads. Such practice may possibly present an appearance more pleasing to the eye, but if anything is detrimental rather than beneficial to the welding. The tubes should be welded after the hydrostatic test to prevent loss of time and welding labor, in case of possible failure in some of the safe-end welds. After the electric welding is completed the boiler should then be filled again with water, but only at the shop line pressure, which usually is at least 50 lb. It will be found that this pressure is amply sufficient for the second test.

When electric welding old tubes which have seen not over one year's service, the same methods are employed, after doing what working over the tubes may require. For old tubes a simple and efficient sand blast may be used. This will clean the set in 30 minutes, care being taken not to use too much sand. The operation of burning off the beads with the acetylene torch can be omitted.

LABOR REQUIRED

It is to be noted with this schedule of operations, the set of 336 two-inch tubes have been removed and renewed complete, ready for service, without removing the steam pipes or dry pipe in 37 hours by one mechanic, with the assistance during this time of one helper for 10 hours, two helpers for 8 hours and one apprentice for 13 hours, and then finally an electric welder for 21 hours.

SUPERHEATER FLUES

For superheater flues the same method of removing and applying is followed: the operations for setting, expanding, beading and rolling for superheater tubes is the same as for boiler tubes, except the superheater tubes are beaded over at both ends. The holes in new sheets are 1⁄32 of an in. larger than the nominal diameter of the flue. The copper ferrules should be of a diameter suitable for the flue and No. 13 gage. No ferrules should be used at the front end, but steel shims may be used when necessary.

ARCH TUBES

As the installation of brick arch tubes is similar to tube work, it is good shop practice to include the arch tube work in the tube setter's work. In removing arch tubes, they are burnt off close to the inside of the tube and door sheets with the acetylene torch, and the stub ends carefully split with the torch taking care not to injure the sheets in so doing. They are then readily closed in and knocked out into firebox with hammer and chisel from the outside. After the arch tube plugs have been removed, four 3-in. arch tubes can be removed, by this method, in 30 minutes. Any scale in the arch tube holes can readily be removed with a round file. The old arch tubes removed should be carefully examined and if in good condition, which is frequently the case, they can be used again in the next smaller size firebox, first annealing the ends.

New arch tubes should be ordered 2 in. longer than is absolutely required. After being heated and bent to a standard template for the particular class of engine, they are placed in position in the boiler, gaged for brick, and the exact lengths laid off, allowing the ends to project exactly ¼ in. beyond the tube sheet. This method necessitates cutting off of one end only, which is done on power driven cold saw. Arch tubes of seamless drawn steel tubing ¼ in. thick give the best results. No ferrules are used. After arch tubes have been cut to exact length and placed in their exact position in boiler, the boiler maker with one helper expands the ends tight into the sheet. The ends of the tube should be annealed and the expanding done with the proper sectional expander with special extended mandrel.

In case of new sheets requiring new arch tube holes, the holes are cut after the sheets are in place in the boiler, using the acetylene torch with cutting nozzle secured to a special compass device. This process enables the work to be done very quickly, about 3 minutes per hole. In the case of the outside tapped holes, it can be done sufficiently accurate as to not even require reaming out. The holes securing the arch tubes are smoothed up with air driven reamer requiring about 30 minutes per set of eight holes. Old threads in the outside holes should always be cleaned up with the proper tap, first building up the holes by autogenous welding if necessary to maintain the standard size. After the tubes are expanded in place, the projecting end of the tube is lipped over against the sheet at all points in the circumference, a long stroke hammer and a round three-edged tool being used for this purpose. This process requires very little time and makes a substantial and secure job.

TOOLS FOR SETTING TUBES

It is hardly necessary to state to any modern railroad of today that to keep down the cost and at the same time maintain the highest degree of efficiency, it is necessary that methods be standardized for all tube work in the different shops and engine houses. This of course refers to both the methods of application and the materials used. Instructions must be issued and carried out to insure uniform methods and tools being used; tubes installed at one point must be worked over at another point with tools that fit, otherwise the life of the tube is rapidly shortened. To insure this standardization, all tools and all gages for tools should be

made by or furnished from the general or main shop, at which point master gages are kept; they should not be shipped to the outlying points on their requisitions until after carefully inspected and passed upon by some competent person. All standard gages for beading tools, mandrels and expanders should be available only at the main shop.

All beading tools should be checked at least once every thirty days by the boiler maker foreman or some equally competent person, to see that they conform accurately to the standard gages. Beading tools not conforming to the gages should be returned to the main or distributing shop for repairs. Beading tools should not be repaired at any outlying points. The tools when made should be marked with some suitable identifying symbol, as for example S-1, to S-5 for the straight sectional expanders, or P-1 to P-5 for prossering expanders, the number designating the purpose for which the tool is intended, and also enabling the shop men to specify exactly the standard type desired.

SUPERHEATER UNIT TESTER

The accompanying illustration shows an arrangement for applying the hydraulic test to superheater unit tubes. This was designed and made at the Silvis shops of the Chicago, Rock Island & Pacific. It is made up almost entirely of standard pipe fittings with the joints on the high pressure side of the small cylinder arranged to withstand a pressure of

D until the system is filled and the plunger is pushed to the extreme left. The pet cock at *E* relieves the air pressure in front of the water on the high pressure side, and the pet cock *F* relieves the air pressure on the air side. With the system filled the water supply valve *D* and both pet cocks are closed. The straight air valve *G* is then opened, permitting the air from the shop line to enter the large cylinder. The difference in the diameter of the cylinders creates a pressure of water over two and one-half times that of the air, thus permitting a 250-lb. test pressure to be obtained. A pressure gage is located in one end of the header block. After the test has been made the air pressure is removed and the system is drained through the valve *H*. Two header blocks are made, one with the holes *A* and *B* 3 5/8 in. apart, and one with them 4 in. apart, for two styles of superheater unit tubes used. Pipe connections on both blocks are made the same, so as to be interchangeable with the rest of the apparatus. These blocks are made of cast iron.

A CENTERING MACHINE

BY E. F. GLASS

The accompanying sketch shows a device for centering pins of larger diameters than can usually be accommodated on the ordinary centering machine. In use it has proved to be both rapid and accurate.

It is made of a small speed lathe, fitted with a sliding

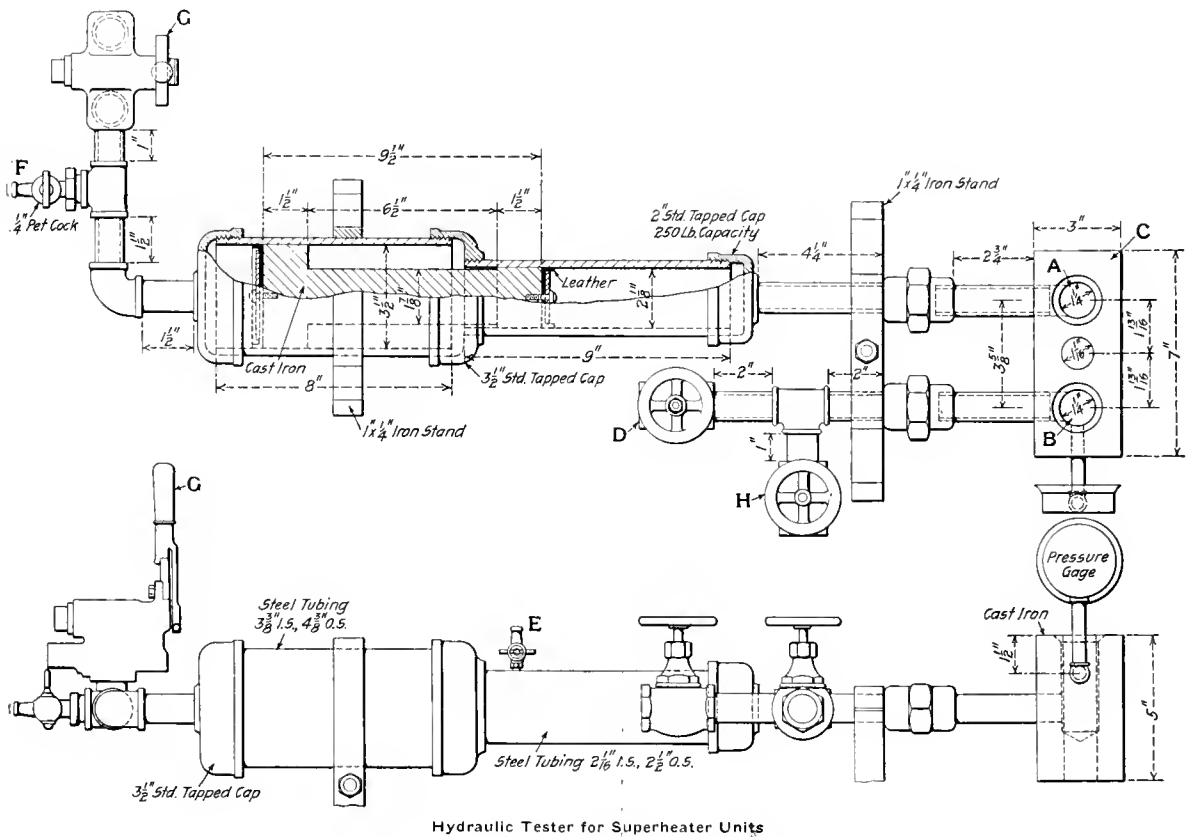

250 lb. per sq. in. The large cylinder of 3 1/2 in. diameter is made from steel tubing. In this is located the cast iron plunger, the other end of which operates in the other cylinder of 2 1/4 in. diameter, also made from steel tubing. The unit pipes are clamped to the header block *C* by a bolt.

Water from the shop supply is admitted through the valve

spindle and lever. It has a head block *A*, which has a taper bore varying in diameter from 1 3/4 in. to 3 1/2 in. The larger diameter of the bore should be 1-16 in. greater than the head of the largest pin to be centered. The device will center pins from the largest to the smallest diameter of the bore in the head block without any adjustment and if desired, an aux-

iliary bushing which is turned to fit the block as shown at B, may be applied for smaller work.

In operating the machine it is only necessary to adjust the tailstock to conform with the length of the pin to be centered. Then the head of the pin is placed in the bore of the block A and run up by the tailstock center until it fits tightly in the hole. The chuck on the end of the spindle is fitted

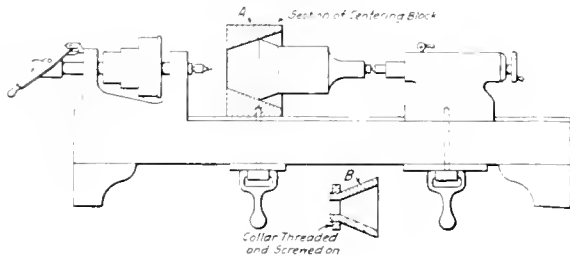

Centering Machine Developed from an Old Lathe

with a combination center drill and it is only necessary to pull the lever forward to force the drill into the head of the pin and form the center hole.

This machine has been used for centering pins which have been partly finished in the turret lathe and has materially reduced the time required for this operation.

MAKING STEAM PIPES BY OXWELDING METHODS

BY W. H. HAUSER
Mechanical Engineer, Chicago & Eastern Illinois

A short time ago the Chicago & Eastern Illinois had occasion to equip two locomotives with Schmidt superheaters, and as there were only three engines in the class, a study was made to see if the steam pipes could be obtained without

making new patterns. These patterns would cost approximately \$55 to \$65 each, and would be used at rare intervals after the original application. It was found that the upper portion of the steam pipes for the Mikado superheater en-

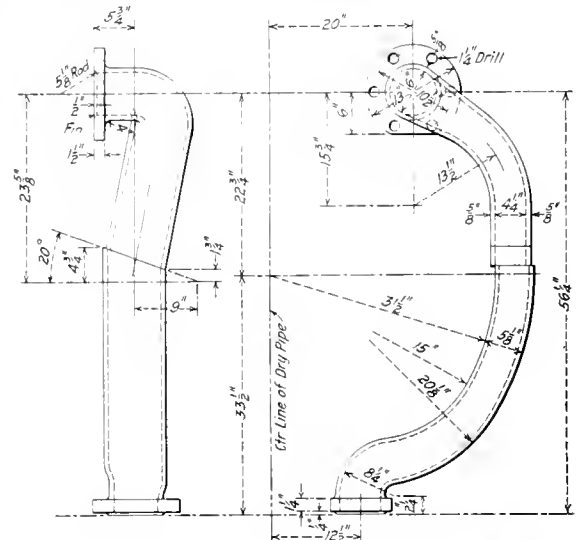

Fig. 2.—Method of Cutting and Welding Steam Pipes

gines could be used with the lower portion of the steam pipes removed from engines being converted, by welding them together by the oxweld process. The steam pipes of the Mikado engines were of the outside type. Fig. 1 shows the two steam pipes used; the one on the left is that taken from one of the engines being converted and the one on the right is the Mikado steam pipe.

Fig. 2 shows where the steam pipes were cut and how closely they matched. The pipes were laid off according to

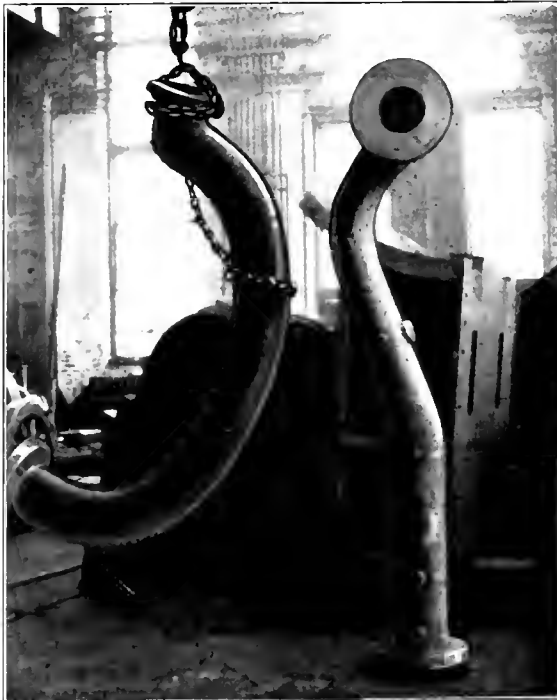

Fig. 1.—Castings from Which the Steam Pipes for the Superheater Locomotive Were Made

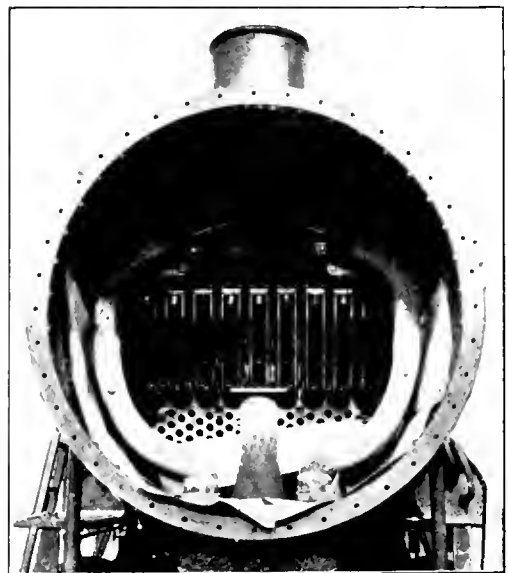

Fig. 3.—Welded Steam Pipes After Testing

the drawing, and were then set on a slotter and cut to the line. The two sections were completely machined and then placed in the engine, bolted in place and adjusted to the

proper fit. The two sections were then tied together by welding them at opposite points for a distance of about 1½ in. The pipes, with the sections thus fastened together, were then taken down and the welding operation completed. The pipes were welded at a cost of about \$1.50 each. The cost of the new Mikado pipe was approximately \$12 with salvage from the lower half of about \$3, making the cost of the new pipe approximately \$9 plus \$1.50, or \$10.50, whereas had new patterns been made the pipe castings alone would have cost more than the entire cost by this method. The application of the steam pipes in the superheater engine after the pipes were welded is shown in Fig. 3.

In another case it was desired to convert a locomotive of the cross compound type, the only one of its class, to a simple engine. In order to make the change it also would have been necessary to make two new steam pipe patterns, but this was obviated by using a combination of steam pipes in a way similar to that described above. Fig. 4 shows this installation. The original tee-head in the engine was a three-bolt tee-head. A standard four-bolt tee-head was applied and

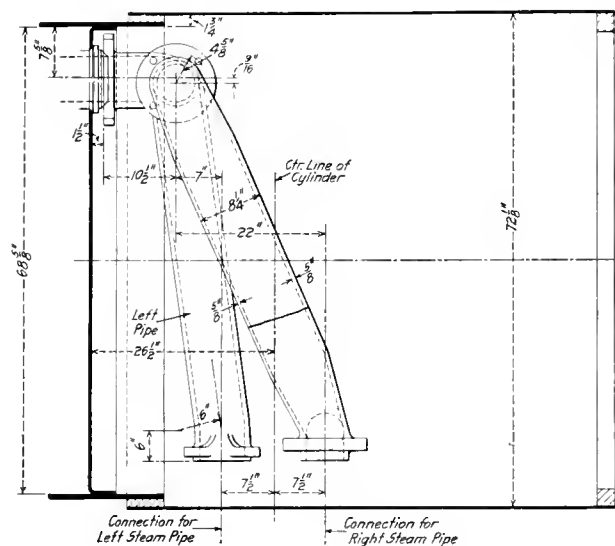

Fig. 4—Welded Steam Pipes for a Converted Cross-Compound Locomotive

the top flange of the original steam pipe was cut off and a flange from a right hand steam pipe, of which there was a pattern, was welded on. This made the left hand pipe complete at a cost of about \$1.50. The right hand pipe was made from a new right hand pipe of which there was a pattern. This was cut just below the center, as shown, and a 16-in. section from the pipe from which the upper flange for the left pipe was obtained, was welded on. To this was welded the lower flange from the original cross compound pipe, which was to be scrapped. In other words, two right hand pipes were used to furnish sufficient material to make the two steam pipes for this engine. The sections of these pipes were also assembled on the engine and partly welded in place and then taken down to complete the welding operations. These steam pipes have all given very satisfactory results and undoubtedly saved a considerable amount by doing away with the necessity of making expensive patterns.

A GOOD BOILER TUBE RECORD.—That high rates of driving are not detrimental to a boiler provided it is accompanied by proper supervision needs no better proof than the fact that the Interborough Rapid Transit Co. has a record of fourteen tube renewals a year out of sixty-four boilers.—*Power.*

BOOSTING THE GENERAL FOREMEN'S ASSOCIATION

Two of the letters received in the competition on the "Benefits Derived from Convention Attendance" were from members of the International Railway General Foremen's Association, and are as follows:

BY C. L. DICKERT

Assistant Master Mechanic, Central of Georgia, Macon, Ga.

What benefits have I derived from attending General Foremen's conventions? Representatives from practically every railroad in the United States and Canada are in attendance and each has something good to offer. My object in attending is the good I get out of them, and I have never come home without something that more than paid the expenses of the trip, and the results were almost immediate. On some occasions methods were described by men located at or near the place of meeting, that I wanted to see in actual operation. I took a side trip with but little expense, thus not only bringing out the advantages of the practice in ques-

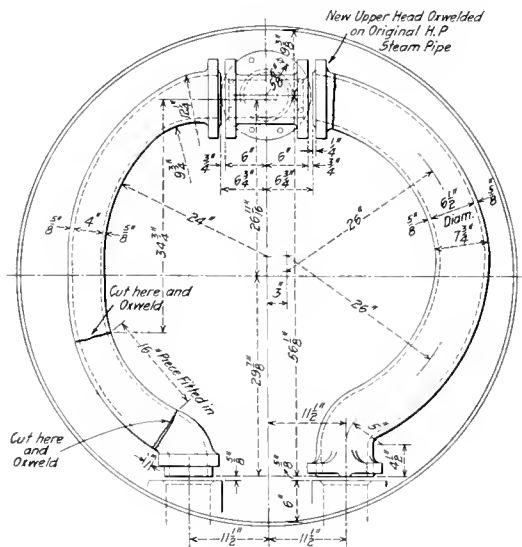

tion more clearly, but getting me in touch with other good practices.

At these conventions we meet and talk with the best informed railway mechanical men in the country, and they talk freely of what they are doing.

To enumerate all the good I have received from attending the conventions would take too much time and space; one instance must suffice. At one of the conventions I learned of a tool used in another shop that cut the time on certain work from hours to minutes. This one thing alone was well worth going after.

The good I get when attending these conventions is not confined to any one department, but covers both locomotive and car departments. I have been able to solve some knotty problems by talking with men from different roads. Something is wrong with the man who takes an active part in the meetings of the General Foreman's Association, and is not benefited thereby.

BY W. W. SCOTT

General Foreman, Delaware, Lackawanna & Western, East Buffalo, N. Y.

My personal experience with railway mechanical associations covers a period of years, but I will confine myself to what I know about the International Railway General Foremen's Association and the opportunity offered its members

to advance in their chosen field by close attention to reports and discussions on shop and roundhouse efficiency and better shop methods which increase shop output at a reduced cost.

One of the best arguments is the book entitled "Shop Kinks" published by the *Railway Age Gazette*. This interesting and valuable book, containing all the best shop kinks up to the time of publication, was the result of several discussions on shop kinks and efficiency at a meeting of the General Foreman's Association; by taking advantage of the ideas contained within its pages, I was able to reduce my cost of output in some cases 30 per cent.

One item in particular might be interesting as an illustration. I found that a roundhouse machinist would lose 35 minutes each nine-hour day in going from his work to the tool room for the wrenches used in his work. We had fifteen machinists at that terminal. In other words, out of 15 the railroad paid and gave away the services of one full paid machinist. This extravagance was removed by introduction of portable tool boxes. It saves labor and gains the company the use of one more mechanic without increasing the payroll.

The limit of 750 words placed on "Booster" articles prohibits me from mentioning other items. All mechanical organizations in general, and the General Foremen in particular, point with reasonable pride to many of their members who have ascended the ladder of opportunity with nothing back of them but their dogged persistency to learn and absorb the best offered at the convention.

Railroads want efficiency, and usually get it, but the average efficiency of a railway shop or engine house is low. It has the practice that comes with a day's work, that's all. A progressive foreman is not satisfied with just a day's work to his credit but wants to know what other men are doing in the same line of endeavor. A trip to the convention brings him back with new ideas to increase the shop output. He is enthusiastic in his work and eventually by his convention activities pays the railroad a substantial dividend on the expense money invested.

TOOLS FOR CUTTING HOLES FOR SUPER-HEATER FLUES

The special cutter shown below is designed for cutting and chamfering the holes for superheater flues in one operation. The shank is made to fit the drill press spindle, and is hollow to receive the pilot pin. The body of the tool is turned in the lathe, with the collar, as shown, extending 3 1/4 in. below the disk. The four recesses are then shaped out and the holes for the tools and set screws are finished, after which the

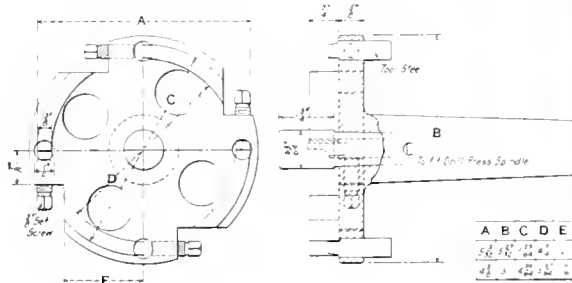

Tool Which Cuts and Chamfers Holes in Flue Sheets

parts of the collar in front of the tools are cut away. The collar thus supports the tools, so that there can be no pivot chattering.

Two tools, set at diametrically opposite points and shaped as shown in the dotted lines, cut the hole through the sheet and the other tools chamfer the edge to a radius of 1/16 in.

The pilot pin can be made of any size desired. At the shop where this tool is used it is the practice to drill a one-in. hole in the flue sheet and a pilot pin of 63/64 in. diameter is used.

SOME ARC WELDING INFORMATION*

II

BY F. G. SAUSSURE†

Perhaps no other machine tool of recent years has made such a great impression upon the mechanical world as has the electric welder, and there are few men engaged in the repair or manufacture of iron or steel commodities who are not more or less familiar with its use.

De Meritus, in 1881, seems to have been the first to



Fig. 1—A 6-in. by 8-in. Frame Section Prepared for Arc Welding

employ the electric arc for welding, but little is known of his experiments except that a carbon electrode was used. The Benardos carbon electrode process was a later development and is still employed for certain classes of work.

The carbon electrode process has the disadvantage that carbon is deposited in the welds, therefore little, if any, machining can be done because of hard and brittle metal. Besides this, the work is limited to a downward position



Fig. 2—The Frame Weld Completed

since it is a puddling process. These objections were overcome by Slavianoff‡ when he developed the metallic pencil process, which is now in most general use.

GENERAL USES

Practically every railroad in the United States uses electric arc welders, and on some systems nearly every shop-

* The preceding article was published in the *Railway Mechanical Engineer*, for February, 1917, page 95.

† Engineer, Siemens-Wenzel Electric Welding Company.

‡ For a discussion of the carbon and metal electrode processes, see the November, 1916, issue of the *Railway Mechanical Engineer*, page 391.

and roundhouse has been given the "putting on tool" that was suggested to the man who "took too much off" or drilled a hole incorrectly. Nearly every part of a locomotive or car subject to wear or breakage has been repaired by arc welding, and the illustrations show a few examples which give an excellent idea of the enormous savings that may be obtained by this process.

A frame of 6-in. by 8-in. section can be prepared and

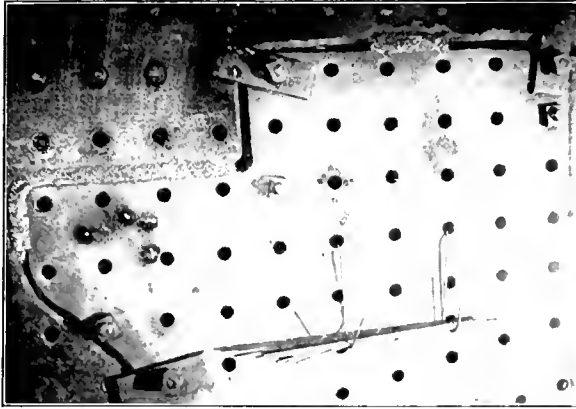

Fig. 3—A Firebox Patch Tacked in Place for Arc Welding

welded (Figs. 1 and 2) in about twelve hours. By the blacksmith method, where the engine was stripped to take the frame to the fire, or oil burners were used to weld in a "Dutchman," the time required was from three to seven days, and the cost over \$200 as compared with about \$20 for the electric process. The firebox that needed a patch or a new half side sheet once gave the boilermaker foreman grave concern, but now, as illustrated in Figs. 3 and 4, the

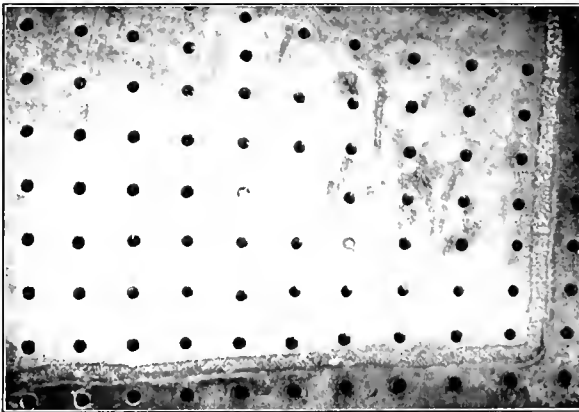

Fig. 4—A Completed Firebox Weld

proposition is not so serious. Locomotive cylinders (Figs. 5 and 6) are welded with savings even more pronounced than in the case of a frame or fire box.

Tubes, however, present the most striking example of the use of electric welding, for since the advent of the welded tube it is not uncommon for a set of tubes to remain in a locomotive until the limit of the time allowed by law. One trunk line furnishes figures showing 20,000 miles per tube failure before welding compared with 50,000 miles per welded tube failure.

Not only on railroads, but in marine repair work, the electric welder has for a long time held an important place

and one in which the principal requirement is reliability of the repairs made.

COST OF WELDING

The relationship between power intake at the motor generator and metal applied at the weld has been found to be from 2.2 to 2.6 kilowatt-hours per pound of metal applied. With a welding current of 175 amperes, about 3.28 lb. of electrodes are used per hour. In the previous article it was shown that 54 per cent must be added to the volume of the opening to find the amount of welding metal required and that 26 per cent of the electrode is wasted in stub ends.

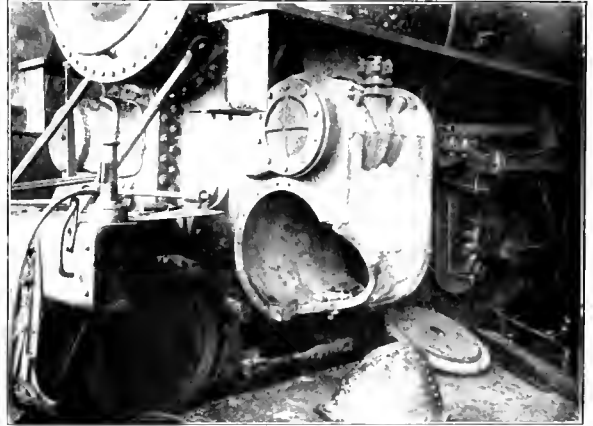

Fig. 5—Broken Cylinder Which Was Repaired by Arc Welding

If the volume of the opening should amount to 5 lb. of metal and we increase it by these percentages, it will take about 10 lb. of electrode to do the work; at 4.28 lb. per hour, the time required will be about three hours, and at 2.4 kilowatt hours per lb. of metal applied (which is 54 per cent over 5 lb.) there will be 18 kilowatt hours, at a cost of about 80 cents. The cost of electrodes at 6 1/2 cents per lb. is 65

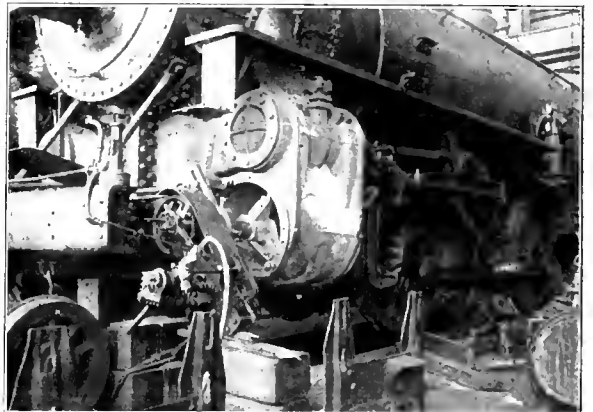

Fig. 6—Reboring the Welded Cylinder

cents. To these charges must be added the cost of labor and overhead, which will more than double the total.

ELECTRODES

There is a definite relationship between the size of electrodes and the proper amount of current to be used. Welding current ranges from 70 to 160 amperes and electrode sizes from 1/8 in. to 5/16 in. It is also of importance that the electrodes be of the best quality. The electrodes should be

clean and bright and of uniform size and chemical composition, and for general work the carbon content should be low. Bad welds are sure to result from the use of improper materials. The best electrodes are those made of either Norway or Swedish welding iron, or certain brands of similar composition manufactured in this country. A little manganese in the welding material does no harm, but the presence of phosphorus or sulphur has the same bad effect as in other iron and steel products.

USE OF FLUX

The pro and con of the use of flux has been much discussed, but though the writer is a firm believer in its use it should be a question for the individual to decide. There is no question of its value in a weld as made in a blacksmith's fire, but the conditions are altogether different. The objects of flux as claimed by advocates for electric welding are two-fold: It purifies the weld, and it excludes the air, thereby preventing oxidation, while the metal is in a molten condition.

Several brands of prepared fluxes are on the market or one can mix his own flux, according to formulas easily obtainable from manufacturers of welding apparatus. To use the flux the powder is mixed up with water to form a paste, the electrodes are dipped into the mixture and allowed to dry. A few minutes in the morning will be sufficient time for the operator to coat electrodes for a day's work.

A NOVEL PLANING DEVICE

BY J. W. HOOTON

A useful tool for planing cylinders is the extension head designed by the writer and used in the N. C. & St. L. shops at Nashville, Tenn. It is designed for finishing cylinders on a planer which will not permit the casting to pass under the cross rail. The extension head is applied to the planer by removing the tool post apron and fastening the extension casting to the head with $1\frac{1}{8}$ -in. studs. The construction,

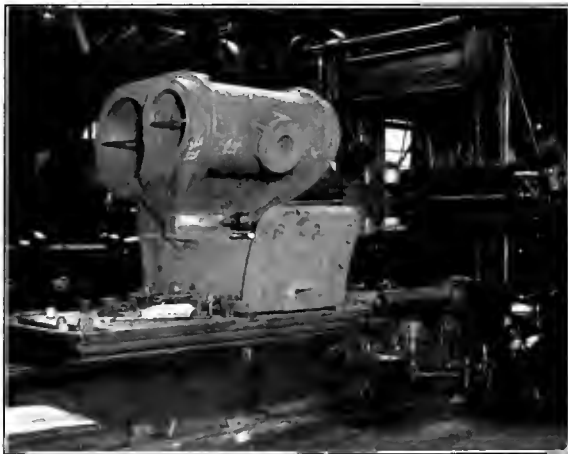

Extension Tool Posts for Planing Cylinders Which Will Not Pass Through the Planer Housings

which is very simple, can be readily seen from the short extension shown on the side head of the planer. The tool at the end can be set to any position and by turning the head a cut can be taken at any angle, which makes it possible to plane the cylinders in the most convenient position and thus saves time.

The upper extension head is 48-in. long and a shorter arm 36-in. long, used for planing the exhaust seats, is applied to the side head. This tool has been in use for 15 months

and has planed over 30 cylinders. It has given no trouble and the work has proved to be accurate.

WELDING HIGH-SPEED STEEL TIPS TO TOOLS

BY J. G. FRASER

Many roads have reported good success in the welding of high-speed steel tips to lathe tools by the electric and acetylene welding systems, but welding under pressure by the use of a compound has been confined to the smaller sized tools. However, the Canadian Pacific has developed a method which is giving satisfactory results at the Angus shops, not only on small shanks but also on wheel lathe and other large tools. The method is as follows: The shank is ground or shaped to receive the high-speed steel and is then placed in the furnace along with the high-speed steel tip, which has been drawn to shape and ground clean on the welding face.

They are heated to a red heat, or about 1,500 deg. F., removed from the furnace and cleaned of scale, and compound is applied to the shank. The tip is then set on and placed under an air press and pressed down until the compound has firmly adhered to both the tip and the shank. The tool is then replaced in another furnace and heated up to 2,000 deg. F., removed from the furnace and placed under the press again for a final pressure, after which it is cooled off under the air blast, or it can be cooled at atmospheric temperature with very good results.

The shanks may be drawn down from old axles or tires, or, if they must be purchased, steel with from .30 to .50 carbon is the most satisfactory. This welding is applicable to any kind of tools regardless of their use; wheel lathe tools which are used in extraordinarily heavy service stand up as well as the smaller tools. The percentage of losses is approximately 2 per cent; that is, two tools fail in every hundred welded, and this is discovered in the smith shop by a simple test system.

The cost of oxy-acetylene welded tools is, material 61 cents, labor 35 cents, a total of 96 cents. The electric process costs, for material 23 cents, labor 15 cents, a total of 38 cents. The welding compound process costs, for material 10 cents, labor 11 cents, or a total of 21 cents. This method effects a considerable saving and the results are highly satisfactory.

REPAIRING CRACKS IN THE FLANGES OF TUBE SHEETS

BY DANIEL CLEARY

It often happens that a flue sheet which is in fair condition has troublesome cracks extending from the rivet holes to the calking edge of the flange, and also short cracks leading from the rivets towards the knuckle of the sheet. These conditions are usually found where the flue sheets are fastened with cone head rivets and sometimes the flue sheet will be found to have drawn away from the side sheet. The method of repairs given below has been used successfully to overcome the trouble due to these conditions.

The heads of the rivets should first be cut off, but the rivets should not be backed out of the sheet. The flanges should then be scarfed with a pneumatic hammer from the rivet holes to the calking edge of the plate at the calking edge. All the rivet holes should then be countersunk. If the flue sheet has drawn away from the side sheet, heat the flange with an oil burner and when the proper heat has been secured, remove the burner and put machine bolts through the rivet holes where needed, then draw flue sheet up to its place and hammer it so that it will fit up well against the side sheet. With good workmanship, this method will prevent further trouble from the cracks in the tube sheet.

New Devices

FOX SENSITIVE MULTIPLE DRILL

A small, inexpensive, sensitive multiple spindle drilling machine to be used for light drilling, counter sinking, etc., has been placed upon the market by the Fox Machine Company, Jackson, Mich. It is of simple construction and was brought out to fill the urgent need for a machine that could take care of the multitude of light jobs of drilling, counter sinking, etc., for which the heavier multiple drills are not well adapted.

The machine as regularly built is shown in the illustration, but if it is desired to be used as a bench machine, the base can be mounted on a thin base plate. The column and base are of box construction, with the table cast separate, so that various size tables or special fixtures can be placed on the base. The table has a wide oil flange and an oil drain pocket, with T-slots in the flange to receive clamping bolts securing jig stops to the table. Hyatt roller bearings are used upon the idler pulleys and the drive pulley on the vertical shaft

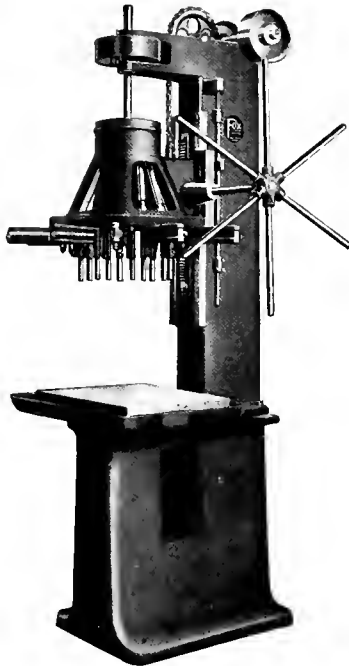

Fox Sensitive Multiple Drill

runs in bronze bushed bearings, end thrusts being taken up by ball bearings.

The machines are designed to take drills up to $\frac{1}{2}$ -in. in diameter and are furnished with either 9-in. or 12-in. round heads which can be equipped with from two to ten spindles one-in. in diameter or from two to sixteen spindles $\frac{3}{4}$ -in. in diameter. All pinions have double bearings turned integral with the pinions and the gears run in an oil bath.

The adjusting arm is of a new type which permits the adjustment to be made very quickly and holds the bearing securely to the arm. The universal joints are of the Fox

patented type which are composed of three parts only, no pins, screws or rivets being used in their construction. The drill spindles are of crucible steel. Sufficient provision has been made for the thrusts upon the ball bearings to reduce the strain at this point.

The builders are prepared to furnish cluster plates for these machines for use on complicated layouts where the regular type of arms cannot be used.

LOCOMOTIVE CYLINDER AND VALVE CHAMBER BORING MACHINE

With a view to eliminating the time lost in resetting cylinders when boring piston valve chambers, the Newton Machine Tool Works, Philadelphia, has lately developed a machine which retains all the special features of its standard cylinder boring machine, but has an unusually large range of adjustment for the table, both vertically and laterally.

This machine, like the former design is adapted to boring and facing both ends of the cylinder at the same time at the most rapid rates permissible with high speed tool steels. The spindle is 7 in. in diameter, has 12 ft. of gear feed and hand adjustment and a rapid power traverse in both directions. In order to permit using small boring bars



Newton Cylinder and Valve Chamber Boring Machine

for boring the valve chambers, the end of the spindle is fitted with a large taper with retaining and drift key slots.

The spindle is caused to rotate in unison with the spindle sleeve by means of a double spline and full length keys. The sleeve revolves in cap bearings, so arranged that the driving worm wheel is supported on both sides. The worm wheel engages with a hardened steel worm, fitted with a roller thrust bearing and both are arranged to be submerged in a bath of oil at all times. The worm wheel drive is particularly advantageous when boring work with intermittent surfaces, such as is encountered in facing the ports of locomotive cylinders as any spring, due to the release of tension under heavy cuts, is taken up by the angular teeth.

The bearing which carries the facing arm is cast integral with the spindle sleeve and as this bearing carries no key it is possible to bore while the facing head hangs stationary

in their usual position, or the facing and boring may be accomplished simultaneously. The engagement of the facing head for rotation is accomplished by swinging a lever attached to an eccentric clamp. The facing head bearing on the sleeve in the outboard spindle bearing is similar to that on the main spindle sleeve.

The work table is 54 in. wide by 72 in. long and has 30 in. of hand cross adjustment. The minimum distance between the center of the spindle and the top of the work table is 39 in. and the maximum distance 51 in. The maximum distance between the ends of the facing heads is 60 in.

The drive is so arranged that the fast power traverse of the spindle may be used while the spindle is not rotating. This feature, together with the rotation of the spindle and the power elevation on the table are operated by levers located on the table of the machine, both along the side of the main head and the outboard bearing, and may be disengaged or engaged without stopping the motor.

For driving the machine, the use of a motor of at least 20 hp. is recommended. With a motor speed of from 400 to 1,200 r.p.m., spindle speeds of from three to nine r.p.m. can be obtained and feeds per revolution of spindle from .0637

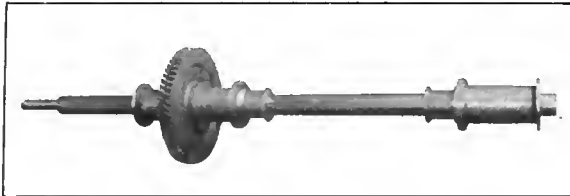

A Spindle and Sleeves Removed from the Machine

to 1.019 in. are available. The reversing quick power traverse of the spindle provides speeds of from 9 ft. to 36 ft. per minute.

The approximate net weight of the machine is 70,000 lb. and the over-all floor space occupied is 31 ft. 6 in. by 9 ft. 6 in., this including the extension for the motor bracket.

A SHIP BAND SAW

A ship band saw for extra heavy sawing, on both straight and curved work, has recently been built by the J. A. Fay & Egan Company, Cincinnati, Ohio. It is designed particularly for use in ship yards, but will also be found useful in railroad car, bridge and pattern shops.

This machine saws to any angle in a full semi-circle, the wheel being carried on a housing mounted on roller bearings and adjustable at any angle up to 45 deg. either right or left of the vertical. The blade may be adjusted by power or hand while the machine is sawing. The wheel shafts are mounted in self-aligning ball bearings. The column is a massive one-piece casting with broad floor bases, designed to carry the wheels without vibration at any angle. An auxiliary column at the rear carries the angling mechanism. The face of the main column is planed and fitted with roller bearings to carry the saw carriage, guides, etc. The table is of iron 48 in. square, and is fitted with rollers to facilitate handling the stock. It is rigidly mounted on the main column and is therefore always level.

The wheels are 48 in. in diameter with a 3 in. face to carry blades of any width up to 3½ in. They are made with steel spokes and laminated wood rims, faced with rubber. Both wheel shafts are mounted in self-aligning ball bearings with provision for vertical adjustment, side lining and tracking the blade. Both wheels are mounted on a heavy circular carriage, gibbed to the main frame with provision for taking up wear. This carriage travels on self-lubricating, roller bearings mounted in the main column, making the angular adjust-

ment easy. An index is provided to show the exact angle of the saw blade. As the wheels move simultaneously and always in the same plane about a center coinciding with the intersection of the blade and the table surface, the cutting point of the blade is always at the same point on the table surface, regardless of the angle. The straining device is sensitive, compensating for any irregularities and may be set at any tension required for different widths of blades.

The Fay & Egan type guides are furnished, the upper guide being mounted on a square post with a self-contained counterweight. The space between the guide and the table is 24 in. when setting vertical and 16 in. at the extreme angles. The automatic take-up is arranged to maintain the proper tension on the belt at any angle. The power angling device is controlled by means of a handle at the operator's position and is provided with a device which may be set to stop the angular movement automatically at any desired

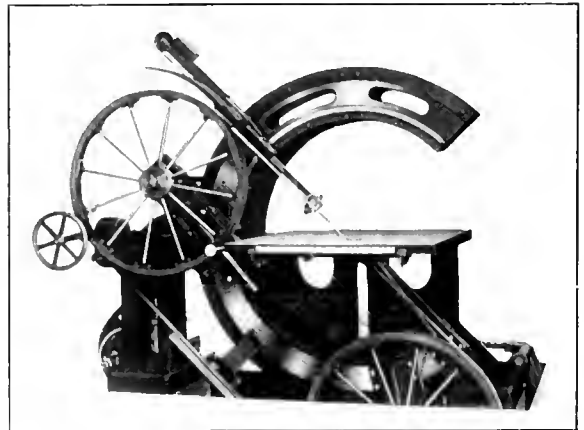

Band Saw with 90 Deg. Angular Adjustment

point. A handwheel provides means for giving a very close setting.

For driving the machine a 15-hp. motor should be used. It may be belted to the main driving pulley or if desired, can be direct-coupled to the drive shaft, in which case a motor of 600 r.p.m. is recommended.

MULLINER QUICK CHANGE LATHE

In the illustration below is shown a small lathe manufactured by the Mulliner Machine Tool Company, Inc., Syracuse, N. Y., which has been designed for extreme rigidity to adapt it to work where accuracy is essential. The machine is built in two sizes, the 12-in. which is fitted with standard beds of four, five and six ft., and the 14-in. which has standard beds of five and six ft. The swing over the carriage is 7½ in. in the 12-in. model and 8¾ in. in the 14-in. model.

The bed is double walled in the cross girths and ribbed transversely, forming a very rigid construction. As the metal on the ways is harder than that on the carriage bearings, the wear which takes place is largely confined to the carriage, so that the accuracy of the machine is not impaired. The carriage has an unusually wide bridge and long vees. The apron is made in a double wall section, giving all important studs and shafts an outboard bearing. The compound rest is rigidly designed, with full contact surfaces and full length taper gibs, having end screw adjustment.

The quick change gear mechanism, mounted on the front of the machine, gives 37 different threads and feeds. The cone gears of the quick change mechanism are cut with the improved Brown & Sharpe 20 deg. involute cutters, forming

a pointed tooth slightly rounded at the top. This is the most satisfactory form of tooth to use in a tumbler gear mechanism, as it permits instantaneous engagement of the gears without clashing, and also provides a stronger section than 14½-deg. teeth. To permit of the application of extra change gears for the purpose of cutting special or metric threads, these new

angle of the thread being such that it will not act as a cutting tool.

The tools are made by the Cleveland Twist Drill Company, Cleveland, Ohio, and come in sets of three different sizes, thus providing for the removal of studs of a considerable range in size.

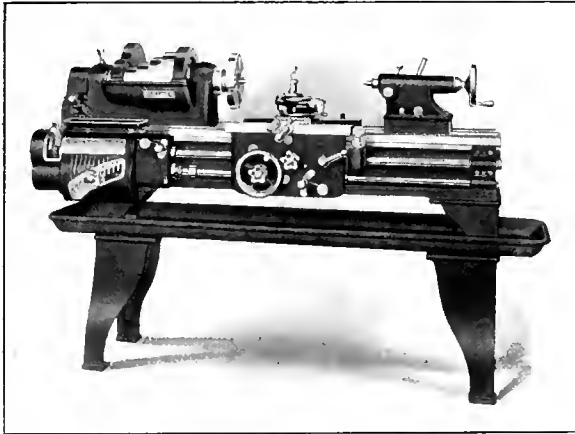

Mulliner Quick Change Lathe.

pattern lathes are provided with an auxiliary quadrant, which is located on the end of the bed and carries the gears connecting the head with the quick-change mechanism. The drive is through a four-step cone pulley and a double friction counter-shaft is regularly supplied with all lathes. The standard equipment does not include taper attachment, but it can be provided if desired.

REMOVING BROKEN STUDS

A tool for removing broken studs is shown in the photograph. It will be noted that it has a thread in the shape of a helix, which is left handed. In case it is desired to remove a broken stud, a hole is drilled in the outside end of the stud with as large a drill as possible. This hole should be deep

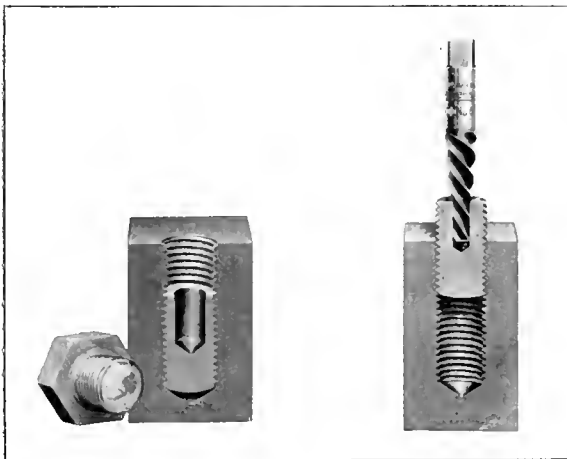

Broken Studs Being Removed

enough to give the stud extractor a firm grip when it is introduced. By turning the tool in a left hand direction, the extractor is driven into and grips the stud, and the broken bolt may be turned out. If the stud is very tight in the hole the edge of the thread will bite into it and grip tighter, the

CONSTANT CURRENT, CLOSED CIRCUIT ARC WELDING SYSTEM

Arc welding practice as it exists today is based on the operation of arcs from constant potential circuits and since arcs operated under these conditions are unstable, it is necessary to connect in series with each arc a ballast resistance. The arc welding generators operate at from 60 to 70 volts. A normal welding arc consumes about 22 volts and any voltage produced by the generator in excess of this must be absorbed in resistance and wasted. Arcs which are operated in multiple require a separate circuit from some point where the voltage regulation is close and, on account

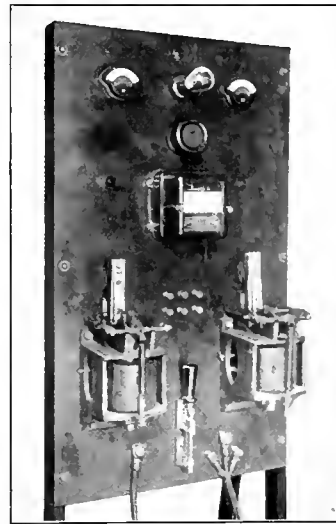

Individual Arc Panel

of the expense of low voltage distribution circuits, practice has tended toward the single arc unit, portably mounted.

The Electric Welding Company developed in their practice a new system of arc welding and the Arc Welding Machine Company, New York, has perfected the system, now known as the constant current, closed circuit system, which operates arcs in series.

This method has all the advantages of series distribution, namely, the size of wire is uniform

throughout the system and carries a uniform current independent of the length of the circuit, as well as of the number of operators. The circuit is simply a single wire of sufficient cross section to carry the current for one arc, run from the generator to the nearest arc, from there to the next, and so on back to the generator. Wherever it is desired to do welding, a switch is inserted in the line and a special arc controller provided with suitable connections plugged in across the switch whenever work is to be done. These controllers may be made portable or permanently mounted at the welding station.

The generator is a special machine and consists of two units, the generator proper, which furnishes the energy for welding, and the regulator, which automatically maintains the current at a constant value. The regulator is excited from a separate source and by varying its excitation with an ordinary field rheostat, the main welding current may be set at any value within the range of the machine, and once set it will automatically maintain that value.

Each arc that is operated on the system is equipped with an automatic controller, which serves two essential purposes. First, it maintains at all times the continuity of the circuit so that one arc cannot interfere with any of the others when it comes on, or goes out of the circuit. Second, it controls automatically the heat which can be put into the metal of the weld. The current through the arc is adjusted by shunt-

ing any desired portion of the main current around the arc. The regulation characteristic of the arc is adjusted by a series-parallel resistance, which is patented.

Provision is made in this system for stopping the arc whenever the voltage in the arc exceeds the predetermined value, which is adjusted to suit the work and the operator.

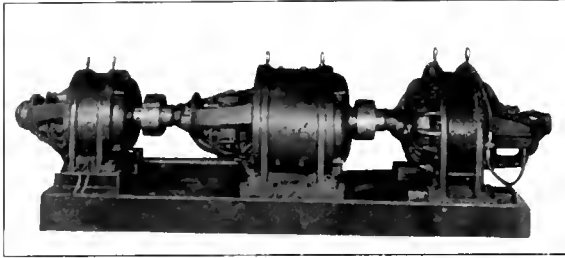

Motor Generator Set With Regulator

This makes it impossible to draw a long arc and burn the metal. The arc is not broken when the welding operation is stopped, but is killed by a short circuit which is placed across it. The number of arcs that can be connected in series is limited only by the voltage, but up to the present time 12 is the maximum number for which machines are constructed.

RYERSON BOILER TUBE RECLAIMING MACHINE

The reclaiming of old boiler tubes has in the past been given very little consideration, due in general to the fact that the reclamation of old materials has only been taken up seriously by the railroad companies within the last few years.

Since the railroads have stopped the practice of welding several safe ends to flues, they are confronted with the problem of disposing of a large number of short tubes, which are in good condition and can be used, provided they can be welded together to make up the lengths required with not more than one or two welds.

For the reclamation of tubes by welding, Joseph T. Ryerson & Son, Chicago, Ill., have developed a machine which not only provides a satisfactory flue reclaiming unit, but may be utilized also for the regular safe ending operations.

The machine is of the hammer type with a special mandrel

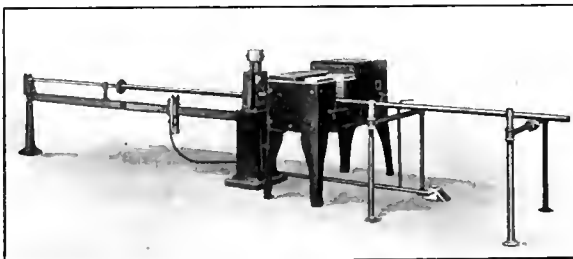

Furnace and Welder Which Can Be Used for Safe Ending or Reclaiming Flues

on which the flue is placed. In operating, the tube is heated and belled out in the usual way and the safe end, or shorter tube inserted. The tube with the safe end inserted is then passed through the furnace and over the mandrel until the point of the weld is in the proper place for heating in the furnace. When the desired temperature is reached, the tube is shoved forward through the furnace under the welding dies, the welding machine being in direct line with the furnace opening. A stop or guide is arranged on the mandrel and

this acts as a gage to locate the welding point under the dies as well as an automatic starting device. As soon as the pressure of the tube is taken off the gage stop, the air supply is cut off and the welding machine comes to a standstill. The tube is then pulled back through the furnace and the operation is completed.

By the installation of this tube reclaiming equipment a great number of tubes that are at the present time scrapped may be reclaimed with a large saving.

BRAKE BEAM SAFETY HANGER

Brake rigging failures are a source of annoyance especially when they cause train detentions. The delay may be but for three or four minutes, yet it counts in the record just as much as a longer one. Also occasionally a brake beam will get down and cause a derailment.

To eliminate these troubles, E. O. Elliott of the Philadel-

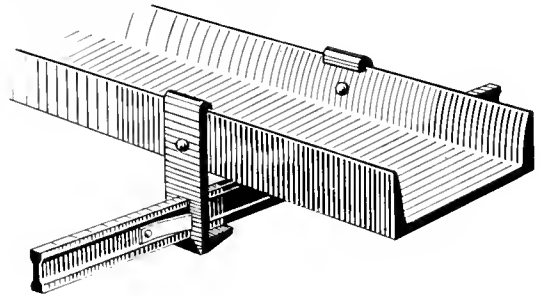

Application of Safety Hanger

phia & Reading patented a safety hanger of simple and effective construction.* This hanger has been further developed by the American Steel foundries and the resulting design is shown in the drawings. It consists of two brackets riveted to the sides of the spring plank extending below the spring plank and having a slot in them of a shape to receive the cross rail which acts as a safety guard. There are two springs riveted on to the cross rail with open ends pointing

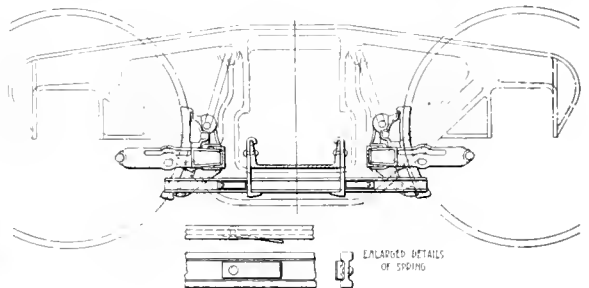

Safety Hanger in Place On Truck

toward each other. The distance between the ends of these springs is slightly greater than the distance between the two supports on the spring plank. The cross rail can therefore be introduced or removed at pleasure by compressing one of these springs and pulling it through the support.

*Original construction described in Railway Age Gazette, Mechanical Edition, August, 1913, page 43.

HIRING AND FIRING.—The power to hire and discharge extended to a number of individuals has given rise to abuses and friction which have cost the employer dearly. Nothing is more fatal to sound organization than such power without adequate supervision and check. Petty executives should never be entrusted with this vital function. Hiring men and discharging men are serious affairs.—*Engineering Magazine.*

EXTENSION COACH STEP

The Duluth, Missabe & Northern has installed on a number of its coaches the extension coach step shown in the accompanying illustration. The arrangement is operated

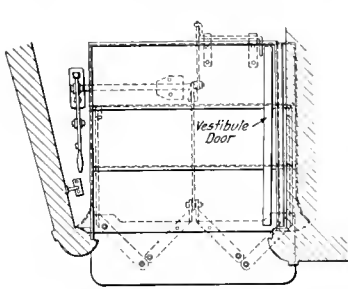

Plan View.

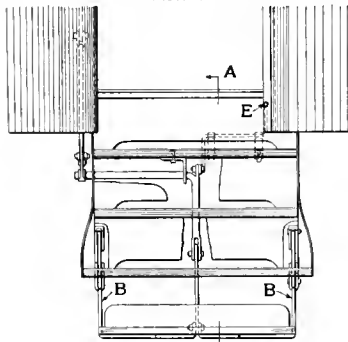

Elevation.

Step in Down Position.

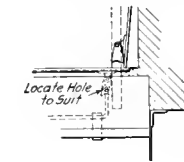

Details of Safety Catch and Guard.

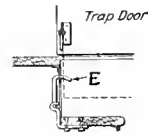

Note: Neither Trap Door nor Vestibule Door can be Closed with Safety Catch Lever in Position shown. Raising Step Releases both to Close.

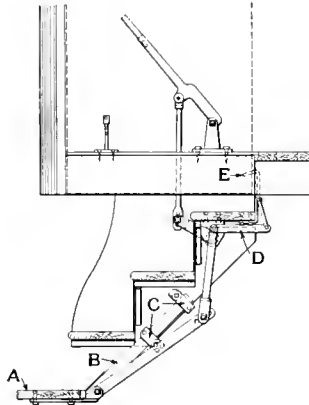

Section A-A.

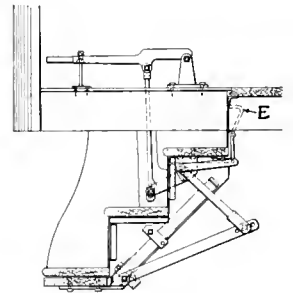

Section A-A. Step Up.

Extension Coach Step for Passengers Cars

through a system of levers from the coach platform, the installation shown being that for a vestibule car. The step A is supported by the arm B, which operates in the bracket C. These brackets are attached to the inside of the step support and each contains one roller, the upper bracket having the roller on the upper side and the lower bracket on the lower side. This permits a free action of the supporting arm C as the step is raised and lowered. The step is operated by means of a hell crank lever, one end of which is connected by a link to the operating handle, and the other end by a link to the extension step itself. As the handle is raised the step will be lowered, and as the handle is lowered the step will be raised, the action being clearly indicated in the illustration.

As a safety measure, the device is arranged so that it is impossible to lower the step while the vestibule trap door is down, or to close the vestibule door before the step is up. This is done by means of the link D, which is attached to an extension of the long arm of the bell crank lever and which operates the safety catch E. This safety catch extends through a hole in the foot step of the upper step, just below the platform, and on the extreme right. A flat dog hanging loosely on a pivot attached to the trap door covers the hole in the foot step when the trap door has been fully closed. This makes it impossible for the safety catch to extend through this hole and therefore makes it impossible for the step to be lowered. In case the trap door is closed before the step has been raised the flat dog will rest on the safety catch, thus preventing the trap door from closing sufficiently to permit the vestibule door to be closed. With the step in the up position the handle is locked in a suitable catch attached to the platform of the vestibule. It has been tested with a weight of 910 lb. It was invented and patented by John T. Rodenbur, 218 Fourth Ave., West, Duluth, Minn.

Zero journal box cooler has a capacity of 5 1/2 gals. and weighs 12 lb. when empty. It can be attached quickly to the journal box and when applied cannot swing out. The cooler extends out from the journal box only three inches. A chain is used to fasten the cooler in place.



A Journal Box Cooler Which is Attached Directly to the Journal Box

"No percentage to be added to charges for repairs made on authority of defect cards issued prior to January 1, 1917, regardless of date of repairs.

"No percentage to be added to bills rendered by car owners for material furnished by them for repairs to their cars on foreign lines.

"No percentage to be added to bills covering settlement for destroyed cars or trucks, under Rule 112."

The above provisions also apply to passenger equipment cars.

PROPOSED LEHIGH VALLEY ELECTRIFICATION

The Lehigh Valley announces that it is making a thorough study of the possibilities and advantages of electrifying portions of its lines through the anthracite region, including the Wyoming division on the main line between Mauch Chunk and Pittston Junction, Pa., and the Mahanoy and Hazelton division, which is a branch line between Penn Haven Junction on the main line and Mount Carmel. The proposed electrification involves 83 miles of double-track main line and 62 miles of double-track branch line, or a total of 145 double-track miles. Based on the cost of similar projects it is estimated that the improvement will involve an expenditure of approximately \$10,000,000, including locomotives.

It is understood that no definite decision has been reached as yet. The road is simply studying the situation and particular attention, of course, is being given to those sections of the line which, because of physical and traffic conditions, are most suitable for electrification. It is of interest to note that one of the sections mentioned includes the city of Wilkes-Barre, Pa., which has a population of about 80,000.

The sections of line being considered for electrification are in the heart of the anthracite region of Pennsylvania, which means that both the traffic and the physical conditions of the road are similar to those on the electrified division of the Norfolk & Western. Both the main line and the branch are characterized by heavy grades and curves, and a large part of the traffic consists of heavy tonnage coal trains moving in both directions over the main line, but principally north-east on the branch. The general merchandise freight traffic on this section of the Lehigh Valley is considerably heavier than that of the Norfolk & Western, however, as it passes through a number of fairly large cities.

Electric power necessary for operating the trains will be obtained from both steam and hydro-electric plants, and it is understood that the power will be purchased. The use of electric power will make it possible to burn a cheaper grade of coal in stationary power plants than is required for steam locomotives, and a considerable saving will thus be effected.

MEETINGS AND CONVENTIONS

Car Inspectors' and Car Foremen's Association.—At the executive committee meeting of the Chief Interchange Car Inspectors' and Car Foremen's Association held in Chicago February 23, it was decided that the next annual convention would be held in St. Louis in the latter part of September.

Railway Storekeepers' Convention.—At a meeting of the executive committee of the Railway Storekeepers' Association in Chicago on February 12 it was arranged to hold the fourteenth annual convention at Chicago on May 21 to 23, inclusive. Committee reports will be presented on the handling of rail, the handling of cross ties, the reclamation of scrap and other subjects. Special attention will also be given to the proper handling of materials distributed along the line, supposedly for immediate use and representing an investment of millions of dollars. An elaborate report will also be presented on the handling of stationery. In addition the committee is planning a number of interesting and novel features for the convention, which will contribute materially to its success.

New York Railroad Club.—The next meeting on Friday evening, March 16, 1917, will be annual electrical night. Edwin B. Katte, chief engineer electric traction, New York Central, the chairman of the committee in charge, has arranged an attractive program. L. E. Johnson, president of the Norfolk & Western, will address the club on the "Economic and Operating Features of the Electrification of the Norfolk & Western" and R. Beeuwkes, electrical engineer of the Chicago, Milwaukee & St. Paul, will present a paper on "The Peculiar Engineering and Structural Features of Electrification on the C. M. & St. P." The club committee is endeavoring to arrange for an operating official of the railroad company to give a talk on the "Economic and Operating Features of the Work," all of which are to be illustrated with moving pictures.

The following list gives names of secretaries, dates of next or regular meetings and places of mechanical associations:

- VIR BRAKE ASSOCIATION.—F. M. Nellis, Room 3014, 165 Broadway, New York City. Convention, May 1-4, 1917, Memphis, Tenn.
- AMERICAN RAILROAD MASTER TINNERS', COPPERSMITHS' AND PIPEFITTERS' ASSOCIATION.—O. E. Schlink, 485 W. Fifth St., Peru, Ind.
- AMERICAN RAILWAY MASTER MECHANICS' ASSOCIATION.—J. W. Taylor, Karpen Building, Chicago. Convention, June 13-15, 1917, Atlantic City, N. J.
- AMERICAN RAILWAY TOOL FOREMEN'S ASSOCIATION.—R. D. Fletcher, Belt Railway, Chicago.
- AMERICAN SOCIETY FOR TESTING MATERIALS.—Prof. E. Marburg, University of Pennsylvania, Philadelphia, Pa.
- AMERICAN SOCIETY OF MECHANICAL ENGINEERS.—Calvin W. Rice, 29 W. Thirty-ninth St., New York.
- ASSOCIATION OF RAILWAY ELECTRICAL ENGINEERS.—Joseph A. Andreuccetti, C. & N. W. Room 411, C. & N. W. Station, Chicago.
- CAR FOREMEN'S ASSOCIATION OF CHICAGO.—Astor Kline, 841 Lawlor Ave., Chicago. Second Monday in month, except June, July and August, Hotel La Salle, Chicago.
- CHIEF INTERCHANGE CAR INSPECTORS' AND CAR FOREMEN'S ASSOCIATION.—W. R. McMunn, New York Central, Albany, N. Y. Convention, September, 1917, St. Louis, Mo.
- INTERNATIONAL RAILROAD MASTER BLACKSMITHS' ASSOCIATION.—A. L. Woodworth, C. H. & D., Lima, Ohio.
- INTERNATIONAL RAILWAY FUEL ASSOCIATION.—J. G. Crawford, 547 W. Jackson Blvd., Chicago. Convention, May, 1917, Chicago.
- INTERNATIONAL RAILWAY GENERAL FOREMEN'S ASSOCIATION.—William Hall, 1126 W. Broadway, Winona, Minn. Convention, September 4-7, Hotel Sherman, Chicago, Ill.
- MASTER BOILERMAKERS' ASSOCIATION.—Harry D. Vought, 95 Liberty St., New York. Convention, May 22-25, 1917, Richmond, Va.
- MASTER CAR BUILDERS' ASSOCIATION.—J. W. Taylor, Karpen Building, Chicago. Convention, June 18-20, 1917, Atlantic City, N. J.
- MASTER CAR AND LOCOMOTIVE PAINTERS' ASSOCIATION OF U. S. AND CANADA.—A. P. Done, B. & M., Reading, Mass.
- NiAGARA FRONTIER CAR MEN'S ASSOCIATION.—E. N. Frankenberger, 623 Brisbane Building, Buffalo, N. Y. Meetings, third Wednesday in month, New York Telephone Bldg., Buffalo, N. Y.
- RAILWAY STOREKEEPERS' ASSOCIATION.—J. P. Murphy, Box C, Collinwood, Ohio. Convention, May 21-23, 1917, Chicago, Ill.
- TRAVELING ENGINEERS' ASSOCIATION.—W. O. Thompson, N. Y. C. R. R., Cleveland, Ohio.

RAILROAD CLUB MEETINGS

Club	Next Meeting	Title of Paper	Author	Secretary	Address
Canadian	Mar. 13, 1917			James Powell	P. O. Box 7, St. Lambert, Que.
Central	Mar. 8, 1917	Annual Dinner; Address by Major-General G. W. Goethals		Harry D. Vought	151 Liberty St., Cincinnati, Ohio.
Cincinnati	May 8, 1917			H. Boutet	90 Carew Bldg., Cincinnati, Ohio.
New England	Mar. 13, 1917	Annual Meeting, Election of Officers and Entertainment		Wm. Cade, Jr.	683 Atlantic Ave., Boston, Mass.
New York	Mar. 16, 1917	Annual Electrical Night		Harry D. Vought	95 Liberty St., New York.
Pittsburgh	Mar. 23, 1917	Revision of Rules of Interchange		J. B. Anderson	207 Penn Station, Pittsburgh, Pa.
Richmond	Mar. 12, 1917			C. F. O. Robinson	C. & O. Railway, Richmond, Va.
St. Louis	Mar. 9, 1917	From Tree to Track	J. H. Waterman	B. W. Frauenthal	Union Station, St. Louis, Mo.
South'n & S'w'n	Mar. 15, 1917			A. J. Merrill	Box 1205, Atlanta, Ga.
Western	Mar. 19, 1917	Training of Men for Positions of Responsibility	F. W. Thomas	Jos. W. Taylor	1112 Karpen Bldg., Chicago.

PERSONAL MENTION

GENERAL

MORGAN KING BARNUM, superintendent of motive power of the eastern lines of the Baltimore & Ohio at Baltimore, Md., has been appointed to the new position of assistant to vice-president, with headquarters at Baltimore, Md., and he will give special attention to the conservation of material of all kinds, from stationery to locomotive and car material, and such as may be used for the maintenance of way and buildings; also to expand the work of reclamation and adopt such other plans as may be advisable in the use of materials and supplies. Mr. Barnum graduated from Syracuse University in 1884 with the degree



M. K. Barnum

of A. B., and later received the degree of A. M. He began railway work in 1884 as a special apprentice in the shops of the New York, Lake Erie & Western, now the Erie, at Susquehanna, Pa., and then, to September, 1887, served as machinist and mechanical inspector. He was then to 1889 general foreman of the same road at Salamanca, N. Y. From January to September, 1889, he was general foreman of the Louisville & Nashville at New Decatur, Ala., and then to September, 1890, was assistant master mechanic of the Atchison, Topeka & Santa Fe, at Argentine, Kan. From September, 1890, to the following June he was superintendent of shops at Cheyenne, Wyo., and then to December, 1898, was district foreman at North Platte, Neb., and later was master mechanic of the Nebraska division at Omaha, Neb., on the Union Pacific. From December, 1902, to February, 1903, he was assistant mechanical superintendent of the Southern Railway and from February, 1903, to April of the following year he was superintendent of motive power of the Chicago, Rock Island & Pacific. In June, 1904, he was appointed mechanical expert of the Chicago, Burlington & Quincy and left that road in April, 1910, to become general superintendent of motive power of the Illinois Central and the Yazoo & Mississippi Valley. In July, 1913, he was appointed general mechanical inspector of the Baltimore & Ohio and in September, 1914, was promoted to superintendent of motive power of the same road, which position he held at the time of his appointment to the new position of assistant to the vice-president, with headquarters at Baltimore, effective February 1.

F. BENDER has been appointed acting engineer of tests at the Angus shops of the Canadian Pacific at Montreal, succeeding G. St. G. Sproule, temporarily a member of the Imperial Munitions Board.

W. D. DEVENY, master mechanic of the Arkansas River and Colorado divisions of the Atchison, Topeka & Santa Fe, with headquarters at La Junta, Colo., has been appointed mechanical superintendent, Southern district of the Western lines, with headquarters at Amarillo, Texas, succeeding A. Dinan.

R. G. BENNETT recently resigned as assistant master mechanic of the Cumberland Valley Railroad at Chambersburg, Pa., to become assistant engineer of motive power of the Pennsylvania Railroad with headquarters at Williamsport, Pa.

CHARLES A. GILL, general master mechanic of the Maryland district of the Baltimore & Ohio, at Baltimore, Md., has been appointed superintendent of motive power of the Eastern lines, with headquarters at Baltimore, succeeding M. K. Barnum, promoted.

H. HONAKER, master mechanic of the St. Louis-San Francisco at Memphis, Tenn., has been appointed assistant general superintendent of motive power with headquarters at Springfield, Mo.

W. L. KELLOGG, whose resignation as superintendent of motive power of the Missouri, Kansas & Texas at Dennison, Tex., has been noted previously, has been appointed superintendent of motive power of the Pere Marquette, with headquarters at Detroit, Mich., succeeding J. J. Walters, resigned to go with another company.

J. C. RAMAGE, formerly superintendent of tests of the Southern Railway, has been made superintendent of tests of the Southern Railway System. Mr. Ramage entered railroad service as inspector in the test department of the Baltimore & Ohio in 1890, remaining with that road in the test and mechanical engineering departments until November, 1895, when he went to the Southern Railway as chief inspector of the test department. He was promoted to superintendent of tests on April 1, 1897, serving in that capacity until his recent promotion.

MASTER MECHANICS AND ROAD FOREMEN OF ENGINES

S. A. BRINSON has been appointed fuel supervisor of the Texas & Pacific, for the Fort Worth division, with office at Fort Worth, Texas.

A. B. DEASON has been appointed fuel supervisor of the Rio Grande division of the Texas & Pacific, with headquarters at Big Spring, Texas.

A. DINAN, heretofore mechanical superintendent of the Southern district of the Atchison, Topeka & Santa Fe, has been appointed master mechanic of the Panhandle division, with headquarters at Wellington, Kans.

F. W. DOUGLAS, chief engineer electrical department of the Atlanta Joint Terminals of the Louisville & Nashville, Atlanta & West Point and Georgia railroads at Atlanta, Ga., has been appointed master mechanic, in addition to his other duties, succeeding G. W. Eaves, resigned.

I. H. DRAKE, master mechanic of the Pecos division of the Atchison, Topeka & Santa Fe, with office at Clovis, N. Mex., has been appointed master mechanic at La Junta, Colo., succeeding W. D. Deveny.

JAMES T. EAGAN has been appointed assistant road foreman of engines of the Buffalo, Rochester & Pittsburgh, in charge of the territory between East Salamanca, N. Y., and Du Bois, Pa. Mr. Eagan entered the employ of the Buffalo, Rochester & Pittsburgh as fireman on July 6, 1892, and about five years later was promoted to engineer, which position he held up to the time of his recent promotion.

H. F. EMERSON has been appointed assistant road foreman of engines of the Pennsylvania Lines West, with office at Crestline, Ohio.

O. R. HALE, general master mechanic of the United Railways of Havana, at Havana, Cuba, has been appointed assistant superintendent of motive power of the Cuban Central Railways, with headquarters at Sagua La Grande, Cuba, effective February 1. Mr. Hale began railway work in

1888 as an apprentice in the machine shops of the Southern Pacific at Tucson, Ariz., and in 1904 went to Mexico as master mechanic of the Torreon division of the Mexican Central. He remained in that position until 1912, and then went to Havana as general master mechanic of the United Railways of Havana, which position he held at the time of his recent appointment.

A. K. GALLOWAY, formerly general master mechanic of the northwest district of the Baltimore & Ohio, at Cincinnati, Ohio, has been appointed general master mechanic of the Maryland district, succeeding Charles A. Gill, promoted.

C. W. HYDE, road foreman of equipment of the Chicago & Eastern Illinois, at Salem, Ill., has been appointed master mechanic of the Illinois division, with headquarters at Villa Grove, Ill., succeeding W. R. Meeder, resigned.

W. N. INGRAM, master mechanic, district 5, intercolonial division of the Canadian Government Railways at Edmundston, N. B., has been appointed master mechanic, district 4, Intercolonial division with headquarters at Stellarton, N. S., succeeding H. D. McKenzie, transferred.

CHRISTOPHER KELSO has been appointed acting master mechanic of the Grand Trunk at Stratford, Ont., during the absence of R. Patterson, who has become a member of the

Imperial Munitions Board for the remainder of the war. Mr. Kelso was born in Liverpool, England, March 17, 1876. He came to Canada when 15 years of age, finishing high school at Kingston, Ontario, and subsequently entered the employ of the Canadian Locomotive Company, with whom he remained about ten years. He was then employed by the Canada Foundry Company at Toronto for three and a half years and began railroad work on



C. Kelso

September 2, 1909, with the Grand Trunk at Stratford, Ontario. Mr. Kelso recently completed the revising and installing of the present bonus efficiency system in force on the entire Grand Trunk system.

WILLIAM MALTHANER, formerly superintendent of shops of the Baltimore & Ohio, at Newark, Ohio, has been appointed to succeed A. K. Galloway as general master mechanic of the Northwest district.

H. D. MCKENZIE, master mechanic, district 4, Intercolonial division of the Canadian Government Railways at Stellarton, N. S., has been appointed master mechanic, district 5, Intercolonial division, at Edmundston, N. B., succeeding W. N. Ingram, transferred.

A. E. McMILLAN, master mechanic of the Baltimore & Ohio at Glenwood, Pittsburgh, Pa., has been transferred to Newark, Ohio, as master mechanic, succeeding W. F. Moran.

W. F. MORAN, master mechanic of the Baltimore & Ohio at Newark, Ohio, has been appointed master mechanic at Garret, Ind., succeeding F. W. Rhauk.

T. N. MURPHY has been appointed road foreman of engines on the Atchison, Topeka & Santa Fe, Middle division, with headquarters at Newton, Kans.

F. RONALDSON, heretofore district master mechanic, Farnham division, Quebec district, of the Canadian Pacific at Farnham, Que., has been appointed master mechanic, Ontario district, with office at Toronto, succeeding A. H. Kendall, enlisted for overseas service as captain in the battalion of skilled railway employees now recruiting.

H. H. STEVENS has been appointed master mechanic of the Pecos division of the Atchison, Topeka & Santa Fe, with headquarters at Clovis, N. Mex., succeeding I. H. Drake, transferred.

W. F. STOOPS has been appointed assistant road foreman of engines of the Pennsylvania Lines West, with headquarters at Conway, Pa.

D. H. VARNELL has been appointed fuel supervisor of the Texas & Pacific for the Louisiana division, with headquarters at Alexandria, La.

IRVING WILLIAMS has been appointed assistant master mechanic of the Cumberland Valley Railroad at Chambersburg, Pa., succeeding R. G. Bennett, resigned.

CAR DEPARTMENT

P. ALQUIST, superintendent of the car department of the Missouri, Kansas & Texas, with headquarters at Denison, Tex., has resigned to take a similar position with the Pere Marquette at Detroit, Mich., effective February 1.

A. E. CHESTERMAN has been appointed car foreman of the Canadian Pacific at Crowsnest, B. C., succeeding E. Tasker, transferred.

T. P. KLEAVER has been appointed foreman of the car department of the Missouri, Kansas & Texas, at Smithville, Texas, succeeding James A. Boggs.

E. TASKEE, heretofore car foreman of the Canadian Pacific at Crowsnest, B. C., has been appointed car foreman at Field, B. C., succeeding M. J. Jordan, transferred.

SHOP AND ENGINEHOUSE

FRANK E. COOPER, formerly general foreman of the Baltimore & Ohio, at Newark, Ohio, has succeeded William Malthaner as superintendent of shops at that point.

PURCHASING AND STOREKEEPING

F. W. BOARDMAN, general mechanical inspector of the Texas & Pacific at Dallas, Tex., has been appointed fuel agent, reporting to the general manager.

T. FAWCETT, formerly assistant general storekeeper, Western lines of the Canadian Pacific at Winnipeg, has been appointed general storekeeper, Western lines, with headquarters at Winnipeg, succeeding L. O. Genest, deceased.

JOHN B. LIVINGSTON has been appointed storekeeper Western lines of the Grand Trunk, with headquarters at Battle Creek, Mich., succeeding John R. Crowell, deceased.

R. LORDAN has been appointed purchasing clerk of the Evansville & Indianapolis, with headquarters at Terre Haute, Ind.

H. P. MCQUILKIN, district storekeeper of the Southwest district of the Baltimore & Ohio and the Cincinnati, Hamilton & Dayton, at Cincinnati, Ohio, has been appointed chief clerk to the general storekeeper at Baltimore, succeeding A. R. Portlock, deceased.

R. D. QUICKEL has been appointed fuel agent of the Southern Railway, Lines West, with headquarters at Cincinnati, Ohio.

H. J. REED has been appointed division storekeeper of the St. Louis-San Francisco, with headquarters at Cape Girardeau, Mo., succeeding H. G. Cummins, resigned.

H. E. ROUSE, general storekeeper of the Chicago Great Western, with headquarters at Oelwein, Iowa, has resigned to take a position in the purchasing department of the Mark Manufacturing Company, Chicago, Ill.

W. C. WARE has been appointed district storekeeper of Wheeling district and Newark division of the Baltimore & Ohio, succeeding H. Shoemaker, promoted.

W. G. WHITELEY has been appointed acting storekeeper of the Grand Trunk Pacific at Transcona, Man., succeeding W. J. Sturgess, promoted.

OBITUARY

ARCHIBALD BUCHANAN, JR., chief of equipment division in the valuation department of the New York Central at New York, died on February 5. He was born in New York City in 1870, and received his education in the public schools and Cooper Union. In 1890 he entered the service of the New York Central at West Albany, N. Y., as chief draftsman in the locomotive department, and later became foreman of the machine shop. From 1900 to 1903 he was master mechanic with the Delaware & Hudson at Green Island. He then went to St. Albans, Vt., as superintendent of motive power for the Central Vermont, returning to Albany in 1907 as chief of equipment division, with the Second district of the New York Public Service Commission. In 1913 he again entered active railway service as chief of equipment division in the valuation department of the New York Central Lines, with headquarters at Grand Central Terminal, New York.

JOHN HICKEY, mechanical engineer of the Salt Lake & Utah, died at Salt Lake City on February 3, 1917.

W. D. MINTON, for the past 27 years master car builder of the Texas & Pacific, with headquarters at Marshall, Tex., died at his home in that city February 5, aged 69 years.

HENRY GORDON STOTT, superintendent of motive power of the Interborough Rapid Transit Company since 1901, died on January 16, 1917, at New Rochelle, New York.

CHARLES T. TURNER, who was master mechanic at the Mount Clare shops, Baltimore, Md., of the Baltimore & Ohio, from 1903 to 1911, died on January 7, in Baltimore. Mr. Turner had been on the pension roll of the B. & O. since 1911, and prior to his retirement had been in the active service of the company for about 50 years.

JAMES B. WELLS, formerly road foreman of engines of the Middle division of the Pennsylvania Railroad, died at Harrisburg, Pa., on February 3, 1917. He was eighty-two years old and was retired in 1903, having served the company fifty-one years. He brought the first train through the Gallitzin tunnel.

NEW SHOPS

OREGON SHORT LINE.—This company will erect a 5-stall addition to its roundhouse at Glenn's Ferry, Idaho.

BOSTON & MAINE.—This company has given a contract to the H. Wales Lines Company, Meriden, Conn., to build a locomotive shop at East Deerfield, Mass. It will be of brick and steel construction 40 ft. high, 170 ft. wide, and 200 ft. long. The improvements will cost about \$80,000.

SOUTHERN RY.—Enlarged facilities for repairing cars at Spencer, N. C., will be constructed at once, to consist of a new all steel car shed 109 ft. by 600 ft. with a shop adjoining, 50 ft. by 100 ft. Bids are now being asked for the foundation work. The shed will be equipped with overhead cranes for handling car bodies and materials. Additional track room will be provided for handling the increased number of cars to be repaired.

SUPPLY TRADE NOTES

A. Hazelhurst has been appointed sales agent of the American Steel Foundries, with headquarters at Pittsburgh, Pa.

Cyrus J. Holland has joined the selling force of the Keyoke Railway Equipment Company, with headquarters at Chicago, Ill.

H. M. Green has been appointed railroad sales representative of the Barrett Company, New York, with headquarters at 1131 Reedsdale street, Pittsburgh.

Fred S. Hiland, formerly with the Patton Paint Company, Milwaukee, Wis., has been appointed a railroad representative for the Wadsworth-Holland Company, Chicago.

Thomas E. Litchfield, formerly with the railway department of the McCord Manufacturing Company Detroit, Mich., has resigned to enter the service of the Dayton Manufacturing Company, Dayton, Ohio.

C. C. Bradford, for several years sales manager of the U. S. Light & Heat Corporation, Niagara Falls, N. Y., has resigned from the company, effective January 1. Mr. Bradford has announced no plans for the future.

H. A. Matthews, manager of the sales-railway department of the U. S. Light & Heat Corporation, has transferred his headquarters from the Chicago branch office to the company's general offices at Niagara Falls, N. Y.

W. E. Kelly, representing the Patton Paint Company, Milwaukee, Wis., has been appointed district manager of railway sales, with headquarters at Chicago, Ill., succeeding F. S. Hiland, resigned, effective February 1.

Paul Judson Myler has been elected president of the Canadian Westinghouse Company, Ltd., of Hamilton, Ontario. H. H. Westinghouse, the retiring president, has been elected chairman of the board.

Charles H. Eib, for some time past a member of the sales force of the Republic Iron and Steel Company, Chicago, Ill., has been appointed manager of sales of the Chicago district, succeeding D. S. Guthrie, resigned to become affiliated with another company.

D. C. Thomas, superintendent of small supplies in the purchasing department of the Atchison, Topeka & Santa Fe, has been appointed sales representative of the Barco Brass & Joint Company, of Chicago, in western territory, with headquarters at Kansas City, Mo.

H. A. Hoffman, formerly with the General Electric Company (steam flow meter department), has been placed in charge of the Philadelphia branch office of the Lagonda Manufacturing Company of Springfield, Ohio, with office in the Pennsylvania building.

The Gulick-Henderson Company, consulting and inspecting engineers and owning physical and chemical laboratories, announces the removal and consolidation of its general offices from 30 Church street and 120 Broadway to 13-21 Park Row, New York, suite 1932 to 1939.

William Berdan, at one time secretary and treasurer of the Cooke Locomotive Works, since made a part of the American Locomotive Company, and for the past 20 years vice-president of the Paterson Safe Deposit & Trust Company, died at his home in Paterson, N. J., January 21, aged 68 years.

The Modern Tool Company, Erie, Pa., manufacturers of the line of "Modern" grinding machines and threading tools, announces that H. L. Harrison has joined its mechanical staff, with the position of factory manager. Mr. Harrison

was formerly connected with the Packard Motor Car Company, the Maxwell Briscoe Company, and the American Car & Foundry Company.

Thomas Wyatt Gentry, for many years southern sales representative of the American Locomotive Company, died January 8 at his home in Richmond, Va. He was 66 years old, having been born September 19, 1850. He was at one time master mechanic on the Richmond & Danville, now part of the Southern Railway, and entered the employ of the American Locomotive Company in 1893.

The Ryan Car Company, Chicago, Ill., has just acquired about 50 acres of land a short distance from its present plant in that city for the purpose of building a plant for the manufacture and repair of all-steel freight cars. The company's present plant will continue to be used for the manufacture and repair of both wooden and steel cars. It is estimated that the improvements in the way of new buildings, machinery and other facilities will be between \$300,000 and \$400,000.

William M. Bailey has been appointed assistant to A. C. Dinkey, president of the Midvale Steel Company, Cambria Steel Company, Worth Brothers Company and Wilmington Steel Company, effective February 1. Mr. Bailey will have charge of accidents and workmen's compensation, safety and welfare, labor, real estate and housing, police, insurance, contributions and such other matters as may be assigned to him. He will be in charge of organizing an entirely new department of the combined companies. Mr. Bailey was formerly secretary to Mr. Dinkey.

General George W. Goethals announces that he has opened consulting offices in the Wall Street Exchange building, 43 Exchange Place, New York. He has associated with him experienced specialists, and will engage in a general consulting practice in civil, electrical, mechanical and hydraulic engineering. Special attention will be given to examinations and reports on canals, harbors, dry docks, terminals, dams, water power development, water supplies, purification of tropical waters, refrigeration, reinforced concrete structures, organizations, management and public utilities.

Colonel Herbert Hughes, C. B., C. M. G., of Sheffield, Eng., a director of the firm of William Jessop & Sons, Inc., New York, died recently in England at the age of 64 years. Colonel Hughes was lord mayor of Sheffield in 1905-1906, and was prominently associated with the volunteer forces in England. He was at one time a member of the Advisory Board at the War Office. He represented the British government at the International Conference on Trade Marks, held at Washington, D. C., a few years ago. He was well known in legal and commercial circles in New York and at Washington.

The United States Metallic Packing Company, Philadelphia, announces that after a long legal contest its patent No. 914,426, dated March 9, 1909, for the King ring, has been sustained by the United States circuit court of appeals for the seventh circuit, and that the supreme court of the United States has refused the petition of the Hewitt Company that it should review the action of the court of appeals. The company's patent is now definitely established, as is also the fact that the Hewitt Company's ring, the further manufacture of which its suit was brought to stop, is an infringement of its rights.

Edward Weldin Grieves died recently at his home in Baltimore. Mr. Grieves was born in Wilmington, Del., in 1843, and educated in private and public schools of Wilmington. For many years he was superintendent of the car plant of Harlan & Hollingsworth, at Wilmington, which position he relinquished in 1884 to take the superintendency of car building for the Baltimore & Ohio at Baltimore. Mr. Grieves left the Baltimore & Ohio in 1898 to become mechanical ex-

pert for the Galena Oil Company and president of the Farlow Draft Gear Company. He retired from active business two years ago.

Joseph Davis, vice-president and controller of the American Locomotive Company, was formerly controller, which position he has held since 1909. Mr. Davis was born in New York in 1875. He attended high school at Albany, N. Y., and was for three years associated with the controller's office of the Delaware & Hudson at Albany. He later spent three years in the accounting department of the New York Central at New York and then left railway service to run a ranch in Colorado. He entered the service of the American Locomotive Company in 1901 in the accounting department and became controller in 1909.

L. L. Cohen, lately connected with the Safety First Manufacturing Company of Chicago, Ill., and prior to that, western sales representative of the Johns-Manville Company, with headquarters at Salt Lake City, Utah, and also Denver, Colo., has been elected president of the Union Supply Company, with offices at 112 West Adams Street, Chicago, Ill. He succeeds L. Mosier, retired on account of poor health. The Union Supply Company handles products of the Bryant Manufacturing Company, Globe Metal Company, William B. Anderson Foundry Company, Central Steel & Supply Company and the Wine Railway Appliance Company.

Harry B. Hunt, who has been elected assistant vice-president in charge of manufacture of the American Locomotive Company, has been with the company eight years. He was born in New York and graduated from the Massachusetts Institute of Technology in 1897. He spent eight years in the operating and mechanical departments of the Erie Railroad and held the positions successively of mechanical engineer, assistant mechanical superintendent and assistant to the general manager. Since he has been with the locomotive company he has served in the manufacturing, engineering and sales departments, and now returns to the manufacturing department from the sales department.

The American Car Roof Company, Chicago, announces that it has given the following car building companies shop rights to build and apply the Christy roof to freight cars when specified by railway companies: The American Car & Foundry Company, the Cambria Steel Company, the Haskell & Barker Car Company, the Mount Vernon Car Manufacturing Company, the Pressed Steel Car Company, the Pullman Company, and the Standard Steel Car Company. The car builders will absorb the royalty charge, remitting to the American Car Roof Company for the number of roofs built. The Christy roofs are of two types, the all-steel and the insulated steel.

Columbus K. Lassiter, the newly elected vice-president of the American Locomotive Company, in charge of manufacture, has been in the service of the company or its predecessors for twenty-two years. He entered the service of the Richmond Locomotive Works as chief clerk to the president of that company. He was later transferred to the American Locomotive Company's plant at Schenectady (about 1904) and served as mechanical expert for about six years, during the reconstruction of the plant. About seven years ago he came to New York as general mechanical superintendent, and at the outbreak of the European war was also appointed a member of the ordnance committee.

Alexander R. McAlpine, special representative of Bird & Son, died at his home in Chicago on January 14. Mr. McAlpine was born at North Framingham, Mass., in 1850, and went west when he was 20 years old, going to the Bee Line, now a part of the Big Four. During his 15 years with that road he was master mechanic and master car builder. In 1885 he went to the Western Car Company as superintendent. After 15 years with that company he went with the Burton Stock Car Company, and in February, 1902, with

Bird & Son. Mr. McAlpine was well known in the railroad field in and about Chicago, and was actively connected with the Car Foremen's Association of Chicago for several years.

The Combustion Engineering Corporation, 11 Broadway, New York City, announces the doubling of the size of its New York offices. This change was made to accommodate the increase in business due to the constantly increasing demand for its Type "E" stoker for bituminous coal, and the Coxe stoker for anthracite coal. With the enlargement of its offices, this company has added considerably to its staff of draftsmen and engineers. It further announces the organization of six additional erecting units, each under the direction of a superintendent for field work, and the establishment of a service department under the direction of John Morris, who has been associated with the company since its organization.

James D. Sawyer, recently elected vice-president of the American Locomotive Company, in charge of sales, has been in the service of the company or its predecessors since 1898 and its manager of sales since 1907. He was born at Buffalo, N. Y., in 1875. He graduated from Yale in 1896 and entered the employ of the Brooks Locomotive Works at Dunkirk, N. Y., in August, 1898. He worked in various departments until in 1901, when the American Locomotive Company was formed, he became assistant to the second vice-president in charge of sales, with office at Dunkirk. He was transferred to New York in 1904 in the same capacity and held that position until 1907, when he was appointed manager of sales.

Pratt & Lambert, Inc., varnish makers, Buffalo, N. Y., have elected the following officers and directors for the coming year: W. H. Andrews, chairman of the board; J. H. McNulty, president; J. N. Welter, vice-president; J. B. Bouck, Jr., secretary and treasurer; A. C. Bedford, C. M. Pratt, F. W. F. Clark, R. F. Clark, S. N. Griffiths and J. P. Gowing, directors. On January 3 the sales force of the company held its biennial convention at Buffalo. This convention marked the completion of the president's twenty-fifth year with the company. About 75 salesmen and executives attended the meetings and discussed new developments in the chemistry of varnish-making and better methods of marketing the firm's products. F. W. F. Clark, retiring vice-president, made the trip from his home in London, Eng., to attend the convention.

E. W. Richey, who has been elected vice-president of the Standard Forgings Company, Chicago, Ill., was born at Richmond, Ind., on June 10, 1876. He entered railway service with the Vandalia at St. Louis, Mo., in September, 1893. In June, 1896, he became connected with the Chicago Terminal Transfer, and the following month he went with the Duluth, Missabe & Northern at Duluth, Minn. He was with the Union Elevated Railroad of Chicago from October, 1897, until September 1903, when he became general sales agent and secretary of the Standard Forgings Company. On March 1, 1914, he was appointed assistant to the president of A. M. Castle & Company, Chicago, and on August 1, 1916, resigned to become assistant to the president of the Standard Forgings Company, which position he held at the time of his election to the vice-presidency, as noted above.

The National Railway Appliance Company, a new concern, incorporated for the purpose of selling railway supplies, announces that it has taken over the entire railroad department business of the U. S. Metal & Manufacturing Company. The new company will have temporary offices at 165 Broadway, New York City, and the officials elected to carry on the affairs of the concern are as follows: President, B. A. Hegeman, Jr.; first vice-president, Charles C. Castle; vice-president and treasurer, Harold A. Hegeman; assistant to president, F. C. Dunham; secretary and engineer, Edward D.

Hillman. The company has established a branch office in the McCormick building, Chicago, under the immediate management of Walter H. Evans, and a branch office in the Munsey building, Washington, D. C., under the management of J. Turner Martyn. Both managers were formerly connected with the railroad department of the U. S. Metal & Manufacturing Company.

The General Roofing Manufacturing Company of St. Louis, Mo. has announced that it purchased the Mound City Paint & Color Company and the Gregg Varnish Company, both of St. Louis, and the Lockport Paper Company of Niagara Falls, N. Y., on February 1. A new corporation, including these companies, has been organized, and will be known as the Certain-teed Products Corporation. The new company is capitalized at \$25,000,000. The following officers were elected: George M. Brown, president; Smith E. Allison, New York City; Audenried Whitemore, Chicago; J. S. Porter and J. F. Schlafly of St. Louis, vice-presidents; J. C. Collins of St. Louis, secretary and treasurer, and Clinton Brown, assistant secretary and treasurer. All formerly were officials of the General Roofing Manufacturing Company. While the General Roofing Manufacturing Company already has offices in nearly all the large cities, new offices will be opened in Buffalo, N. Y.; Milwaukee, Wis., and Salt Lake City, Utah. The headquarters will remain in St. Louis, as at present.

The Westinghouse Electric & Manufacturing Company announces that the plot of ground recently purchased at Essington, near Philadelphia, will form a new industrial center for the Westinghouse Electric interests. The site embraces about 500 acres, with a frontage of approximately one mile on the Delaware River. Additional transportation facilities will be afforded by tracks from the Pennsylvania and Philadelphia & Reading Railroads. This new center will be devoted to the production of large apparatus, the first group of buildings being for power machinery, principally steam turbines, condensers and reduction gears. The initial development will cost in the neighborhood of \$5,000,000 or \$6,000,000, occupying about one-fifth of the area of the entire plot. The group will consist of the following buildings: two large machine shops, an erecting shop for heavy machinery, forge shop, pattern and pattern-storage shop, and power house. Work will begin on these as soon as satisfactory building contracts can be let. The number of employees to be engaged at the new plant has not as yet been definitely determined, but will number several thousand people, and undoubtedly will in the future equal the number employed at East Pittsburgh, representing over 20,000 people.

Charles T. Schoen, the inventor of the pressed steel car, and at one time president of the Pressed Steel Car Company, died at his home in Moylan, near Philadelphia, February 4, aged 72 years. Mr. Schoen was born in Delaware and was educated in Wilmington. He worked there with his father, Henry Casper Schoen, in whose shops he learned the cooper's trade. He later removed to Philadelphia to assume a position with Charles Scott, who was engaged in the manufacture of car springs. He later developed pressed steel equipment and fittings for wooden freight cars, including car trucks, and finally the complete steel car. The first company to manufacture his steel car was known as the Schoen Pressed Steel Company, incorporated in 1895. In 1899 a combination of this company and the Fox Pressed Steel Equipment Company, which two companies then controlled practically all the pressed steel car business in the country at the time, brought about the Pressed Steel Car Company, of which Mr. Schoen was president until his retirement in 1902. Mr. Schoen was also the inventor of a solid forged and rolled steel car wheel and was head of the Schoen Steel Wheel Company. After his retirement as president of the Pressed Steel Car Company he became chairman of the board of di-

rectors of the company. He was also vice-president of the Colonial Trust Company, of Philadelphia.

H. A. Gray, assistant manager of railroad sales of Joseph T. Ryerson & Son, in charge of eastern territory, has been appointed manager of sales of the railroad department of that



H. A. Gray

company, with headquarters in Chicago. Mr. Gray has been in the service of Joseph T. Ryerson & Son for 16 years. He was born at Alton, Ill., November, 1878, and received his education at the high schools of Evanston, Ill., and at St. Paul's School, Concord, N. H. He entered the service of Joseph T. Ryerson & Son in 1901, and was connected with various departments of the business, both in Chicago and New

York. He became associated with the railroad department in 1913, and in March, 1916, was appointed assistant manager of railroad sales.

W. F. M. Goss, dean of the college of engineering and director of the engineering experiment station of the University of Illinois, has resigned to become president of the Railway Car Manufacturers' Association, effective March 1. This association is an organization of fifteen manufacturers of freight and passenger cars in this country, including the American Car & Foundry Company, the Barney & Smith Car Company, the Bettendorf Company, the Cambria Steel Company, the Haskell & Barker Car Company, the Harlan & Hollingsworth Corporation, the Keith Car Company, the Laconia Car Company, the Middletown Car Company, the Mount Vernon Car Manufacturing Company, the Osgood-Bradley Car Company, the Pressed Steel Car Company, the Pullman Company, the Ralston Steel Car Company, and the Standard Steel Car Company.

The organization has been in existence for several years, but the officers and members have been unable to give due attention to it on account of pressing duties to their own companies. This led to the election of Dr. Goss as president, who will devote his entire time to furthering the purposes of the association. Among the studies he will make in his new work will be the adaptation of cost accounting to the needs of car manufacturers, the prevention of fires and accidents in car plants, and standardization of the design of cars, or parts of cars, the standardization of car specifications, and ways and means of establishing a greater degree of co-operation between the car builders and the railroads to their mutual advantage. A further economy, which it is believed he will effect, will be to prevent the duplication of experimental work by different car builders. If pending congressional legislation is passed legalizing the co-operation of car manufacturers in the promotion of foreign business, Dr. Goss will investigate the best methods of developing that field. In matters of common concern to the railroads and manufacturers relating to car construction, he will have full authority to cooperate with the railways and to give them as much assistance as possible.

The other officers chosen by the association are: Vice-president, J. M. Hansen, president of the Standard Steel Car Company; secretary and treasurer, William Bierman, secretary of the Standard Steel Car Company; executive committee, Mr. Hansen, F. H. Hoffstat, the Pressed Steel

Car Company; W. H. Woodin, president American Car & Foundry Company, and J. S. Ralston, president of the Ralston Steel Car Company.

Charles Haines Williams, of the Chicago Railway Equipment Company, Chicago, was elected first vice-president of the company at its recent annual meeting. Mr. Williams



C. H. Williams

was educated in the public schools of Baltimore, Md., and at the Baltimore Polytechnic Institute, from which he graduated in 1893, and also took a special course in mechanical drawing and machine design at the Maryland Institute. He spent four years as special apprentice in the Mount Clare shops of the Baltimore & Ohio, working in the machine and locomotive shops, the erecting shops and in the foundry, drawing room and test departments. He

left the Baltimore & Ohio to become connected with the Chicago Railway Equipment Company as mechanical inspector, and has been with that company since.

George Henry Hill, assistant engineer of the railway and traction department of the General Electric Company, died of pneumonia at his home in Schenectady, January 31. Many important develop-



G. H. Hill

ments in the application of electric power to new uses owe their success to Mr. Hill's efforts. Early in his career as an engineer, he invented and patented the electric system for operating bulkhead doors on shipboard, which many years ago was standardized by the navy department for United States naval vessels and is used on commercial and naval vessels in many parts of the world; later he assisted in the develop-

ment of the multiple unit system of train control, and in connection with this work produced the multiple unit automatic system substantially as it exists today. During the past few years Mr. Hill devoted considerable time to the electrification of steam railroads and has been an active supporter of high voltage direct current for interurban railways and for steam trunk line electrifications. More recently he was engaged in exhaustive studies of the interference of transmission and railway feeder lines with telephone and telegraph circuits.

Mr. Hill was born at Williamsport, Pa., on December 11, 1872, where he attended the local preparatory schools and Dickinson Seminary. After completing his preparatory work, he entered Johns Hopkins University, graduating from the electrical engineering course in 1895. Immediately upon graduation he became associated with Frank J. Sprague, who was at that time engaged in the development of elec-

trically operated elevators and multiple unit control for railway service. He was advanced rapidly and soon became chief of construction of the elevator department, with his office in New York City. When the Sprague Electric Company gave up its elevator business in 1900 he became chief engineer for the company at Bloomfield, N. J., and was directly responsible with Mr. Sprague for the development of multiple unit control for railway trains.

In 1902 the Sprague patents and interests were taken over by the General Electric Company, and Mr. Hill went to Schenectady to follow the further development of train control. Within two years he had become assistant to F. E. Case in supervision of all train control for the General Electric Company, directing the important steps in the manufacture of car equipments for the Manhattan Elevated in New York, the Boston Elevated, Baltimore & Ohio electric locomotives and later equipments for the Interborough Rapid Transit, the Northwestern Elevated and the Philadelphia Rapid Transit Company. The equipment of the New York Central electric locomotives was also under construction at this time, together with many equipments for foreign countries, including England, France, Italy, Cuba and Peru.

In 1906 Mr. Hill became assistant engineer of the railway and traction department in charge of the group of engineers dealing with the general problems arising in connection with electric railway apparatus and engineering. In this position his ability and experience were invaluable and he was one of the company's most important advisors, aiding in the solution of many difficult problems connected with the railway industry. Articles from his pen on railway subjects have frequently appeared in the technical press and in the proceedings of the American Institute of Electrical Engineers, of which he was an active member. During his active career, Mr. Hill made many inventions, both in the railway and other electrical fields, and between 40 and 50 patents were granted to him.

M. C. M. Hatch, superintendent of fuel service of the Delaware, Lackawanna & Western, has resigned to accept a position as assistant to the president of the Locomotive Pulverized Fuel Company of New York. Mr. Hatch was born in Chelsea, Mass., in 1882. He attended the public schools in that city and in Boston, and spent two years in the Massachusetts Institute of Technology, and two years at the University of California, in the latter institution taking the course in mechanical engineering as a member of the class of 1903. He then spent about 18 months in the shops of the Southern Pacific at West Oakland and Sacramento, Cal., followed by six months in the test department, and six months in the signal department of the same road. In June, 1905, he returned East and went to work in the mechanical department drafting room of the Boston & Maine. He remained with that company until October, 1911, serving during the last five years of that period as chief draftsman. From October, 1911, to April, 1912, he was engineer of tests of the New England lines, that is, of the New Haven, Boston & Maine and the Maine Central. In April, 1912, as above noted, he became superintendent of fuel service of the Delaware, Lackawanna & Western.



M. C. M. Hatch

CATALOGUES

WROUGHT IRON PIPE.—The A. M. Byers Company, Pittsburgh, Pa., recently issued Bulletin No. 27, which contains reprints of letters from users of their products.

TOOL STEEL.—A folder recently issued by the Vanadium-Alloys Steel Company, Pittsburgh, Pa., deals with the company's Vasco special, Vasco electric and Vasco Latrobe carbon tool steels.

TIN PLATE.—The American Sheet & Tin Plate Company, Pittsburgh, Pa., has issued an attractive 28-page booklet, No. 120, entitled "Black Sheets and Special Sheets." The booklet describes the various kinds of tin plate made by the company and contains a number of tables, among them being one of weights of American painted roofing and siding, a bundling table of black sheets, etc. Another of the interesting features of the booklet is a diagram of the manufacture of steel showing the processes from the ore, limestone and coal to fabricated structures, rails, frogs and switches, wire and nails, tin plate, etc.

ENGINE LATHES.—Hill, Clarke & Co., Inc., Boston, Mass., have issued a circular describing the Roulsted 20 in. engine lathe. This lathe is for heavy duty work and has a three-step driving cone for 4-in. belt and double back gears. Eighteen spindle speeds are available, ranging from 7 to 285 revolutions per minute. The semi-quick change gear box gives six changes of geared feeds at the touch of a lever. The apron is of the double plate type and has reverse for all feeds, operating independently of the all steel tumbler reverse in the headstock. The lathe has an actual swing over the bed of 21 in. and on a 10 ft. bed takes 5 ft. 3 in. between centers. The net weight is about 4,900 lb.

ARC WELDING.—This is the title of an interesting and attractive book recently issued by the Arc Welding Machine Company, New York. This company has been formed to market the materials and machinery and the welding practice which has been developed by the Electric Welding Company, organized in New York in 1908. The booklet contains data illustrated by some very interesting line drawings, showing the greater efficiency of electric arc over gas welding, particularly as to the greater concentration of the former. The methods of securing proper welding and heat treating are brought out. One section deals with electric arc control and several pages are devoted to the closed circuit system.

DUST GUARDS.—A most attractive and well illustrated 16-page booklet, recently issued by the Virginia Equipment Company, Toledo, Ohio, details the advantages of proper journal lubrication, and shows how this can be assisted by the use of Virginia Compound Compensating Dust Guards. The pamphlet is in the form of a treatise. The author of it has shown just how much in actual money a railway can lose by using poorly made dust guards, both through additional journal turning and in losses in power by poorly lubricated journals. He shows further that the ordinary wooden and tin dust guard is not efficient, for it does not prevent sand from getting in the journals, nor does it permit proper packing of the journal box. He then goes on to show the advantages of the Virginia Compensating Dust Guard. This guard is built up of layers or piles of wood, placed with the grain running at right angles and cemented and riveted together under heavy hydraulic pressure. It is made in two segments, and so arranged that the compensating devices keep them in positive contact with the axle. Through this arrangement the wear is automatically taken up, the ingress of dust prevented, and there is insured a positive, dustproof resilient contact with the axle at all times.

Railway Mechanical Engineer

Volume 91

April, 1917

No. 4

Locomotive Rod Job Competition

An announcement was made on page 117 of our March issue of a competition on locomotive rod work. This competition will close May 1, and those who have not already done so should start their contribution at once so that they will be finished in good time. Few roads follow the same methods and practices in doing this work. Some do it better and cheaper than others. It is the purpose of the competition to bring together in a concise form, the best practices. Our readers can then choose those which best suit their conditions. In order that the best results be obtained from the competition, all of our readers who feel that they have a particularly good and satisfactory method of doing this work should contribute. Our purpose is to spread broadcast, ideas that will be of assistance to all railroads. These ideas must come from the men on the firing line, so do not hesitate to send in what you have if you think it will be of assistance to others. The three articles, which from the standpoint of practical suggestions are considered to be the best, will be awarded prizes of \$20 each. The contributions must reach our office in the Woolworth Building, New York, on or before May 1, 1917.

Collision Shocks on Steel Equipment

On another page in this issue is a photograph and brief description of a rear end collision which recently occurred on the Pennsylvania Railroad, in which one steel sleeping car was completely telescoped by another. The force of the collision was such that it is remarkable that greater damage was not done to the passenger train equipment. The manner in which the two cars were telescoped, however, raises the question whether or not the use of an anti-telescoping device, which would maintain the underframes in the same horizontal plane, should not be carefully considered. Of course it is impossible to say just what might have taken place had the two cars involved been so equipped; but it is evident that the two underframes were first thrown out of line before the damage was done. On practically all of the more recently built steel passenger equipment in this country, vestibule end posts of heavy sections are provided and the probabilities of telescoping equipment thus constructed are very small, even without an anti-telescoping device. However, where a question of safety is involved and where the conditions to be met when the emergency arises are so uncertain, the use of the additional safeguard is desirable.

Application of Safety Appliances

Even though a request has been made by the railroads for a further extension of time in which to equip freight cars with proper safety appliances, the roads will be open to the most severe criticism if they leave any stone unturned to finish this work at the earliest possible time. The Interstate Commerce Commission held a hearing on March 1, at which several railroad men testified that with the great demand for cars, it would be impossible to com-

pletely equip them with standard safety appliances by July 1, 1917, the date set by law, without greatly inconveniencing shippers. On January 1 there were 296,033 cars unequipped. In the six months prior to that time only 160,000 were equipped and at that rate it was claimed it would take another year to equip all the cars properly. The railroads were strongly opposed in their request for further time by the brotherhoods; H. W. Belnap, chief of the Division of Safety, thought that a large part of the unequipped cars could be equipped if the roads would permit the work to be done by foreign lines.

The commission has had the matter under consideration for the entire month and up to the time of our going to press had not acted on it. Although there is little question but what additional time is needed and should be granted in the interests of public welfare, because of the peculiar conditions which exist at this time, the railroads, if an extension is granted, must not let up for a moment the work of carrying this work to completion; indeed they must go forward with still greater energy and must co-operate with one another more effectively in the actual performance of the work. The M. C. B. Association has advanced to June 1, 1917, the date on which cars not equipped with safety appliances will be received in interchange from home roads. The big problem, however, is to get the cars equipped, so that they may be retained in revenue service after July 1.

Bills of Material

An excellent practice followed by the mechanical department of a Western road is that of attaching a bill of material to every order of reconstruction to be made in its equipment. The bill is made out by the designer as he lays out the work to be done. The size and number of the different parts required in the work is given to the minutest detail. Being the one most familiar with all the changes and additions to be made, he is less liable to omit a necessary part than the man on the job who must study a blueprint to find out what is needed. Further, it enables the foreman in charge of the work to order his material promptly on receipt of the plans for the work. As the material is received it is checked off the original bill and the work is not begun until everything is at hand ready for application. This eliminates delays and insures that the work will be done without interruption.

An Additional Incentive for Fuel Economy

American railroads have given much attention to fuel economy in recent years and incidentally efforts in this direction have been intensified during the past two or three years on many roads because of the necessity for increasing the capacity of the locomotive to the uttermost in the effort to reduce operating expenses by increasing the trainloading. Another factor is entering into the problem which promises to inspire still greater efforts towards fuel economy, and that is the greatly increased cost of fuel. Many roads will find it necessary to pay almost

double the prices per ton which they paid during 1916. President Rea, of the Pennsylvania Railroad, in his testimony before the Inter-state Commerce Commission for an advance in freight rates, stated that seven of the eastern roads, including the Pennsylvania; New York Central; Baltimore & Ohio; Norfolk & Western; Chesapeake & Ohio; Virginian and Western Maryland, paid an average price of \$1.21 per ton for fuel purchased during 1916. It is quite probable that for the coming year they will have to pay an average increase of at least \$1 per ton. President Underwood, of the Erie, stated that the surplus of \$4,500,000 for last year would be entirely absorbed this year by the increase in coal prices alone. President Rea estimated the increase in expenses for 1917 as compared with 1916 for the Pennsylvania system as follows Taxes, \$500,000; fuel, \$10,200,000; increased price of materials, \$11,000,000; wages, Adamson law, \$13,500,000; wages other employees, \$7,400,000; total, \$42,600,000. Because of these greatly increased expenditures to which all of the railroads are being subjected it will be necessary to practice severe economies and to do everything possible toward improving the efficiency of operation. Of the items mentioned above, fuel is the only one on which any great saving can be made, the other items being very largely fixed except as they may be affected by increasing the trainload and securing better carloading; thus utilizing the plant and equipment to better advantage.

Efficiency of Motive Power

Approximately one-tenth of the money expended in the operation of American railroads is required for fuel for locomotives. Next to wages it is the largest single item of operating expense. That the extent of the saving which may be effected through the reduction of fuel consumption by even a small percentage is generally appreciated, is evident from the careful supervision which the handling of the fuel supply receives, from the mines to the locomotive firebox. The benefits of such supervision cannot be overestimated, but it cannot go beyond the firedoor. Once in the firebox, the amount of work which is to be secured from the fuel consumed is largely in the hands of the designer.

Much has been done to improve the efficiency of the locomotive by the addition of fuel saving devices, but more attention should be given to the proportioning of the locomotive itself, in order that the highest possible efficiency may be obtained at every step in the process of converting the heating value of the fuel into drawbar horsepower. One of the features most carefully investigated in a proposed stationary power plant installation is the cost in fuel per kilowatt hour of energy delivered. There are few mechanical department officers responsible for new power house installations who will not know the number of pounds of coal required to produce a kilowatt hour in even a small plant. With hundreds of locomotives in operation, each having a capacity ranging from 500 to 2,000 hp., few mechanical department officers can say even approximately how much work at the drawbar they are getting from the coal consumed.

It is natural that in buying new locomotives, the mechanical department officers should give the greatest attention to mechanical details affecting the future cost of maintenance, this being a problem most directly affecting the work of the department. But the possibility of improving locomotive performance and reducing the cost of conducting transportation by increasing the efficiency of future locomotives should not be overlooked. More attention should be given to the study of the future requirements for motive power in order that time may be given to develop and refine the design best adapted to meet those requirements before the power is actually needed. After a decision has once been made to purchase new locomotives, the time at the disposal of the designer usually permits of nothing more than the assembling of a number of details, which will do but little more than to

meet the requirements as to maximum engine tractive effort.

What may be accomplished by careful engineering in the development of a locomotive design is clearly shown in the performance of the Pennsylvania Atlantic type, Class E6s, on the testing plant at Altoona, Pa., an account of which will be found elsewhere in this issue.

No doubt the work of the test plant was invaluable in the development of these engines, and such facilities are not available to other roads. If, however, the fundamental knowledge as to correct locomotive proportions which is available at the present time, were used in the design of every locomotive built, it is safe to assume that the average efficiency of our motive power would be considerably higher.

Improving Roundhouse Facilities

The roundhouse is closer to the actual work of conducting transportation than any other part of the railroad under the supervision of the mechanical department and its importance is generally realized, yet there is a strange indisposition manifested by some officers of railroads towards keeping roundhouses in efficient condition. New roundhouses are, of course, built from time to time, and in their construction and equipment the best practices are usually followed, but the average roundhouse is given little consideration until some difficulty develops which makes it imperative to provide improvements.

The fact that the need of good facilities at roundhouses is given so little attention is largely the fault of the roundhouse foreman. In the operation of an engine terminal there are certain inconveniences which cannot be eliminated. The foreman realizes the fact and comes to look upon the unnecessary evils in the same light that he regards the inherent difficulties in his work. The roundhouse foreman always has troubles too numerous to mention and he does not want to complain for fear that he will be considered a grumbler, so if he mentions his troubles to his superior officer he fails to register an emphatic protest against the conditions which he knows could be remedied. As a result, when appropriations are made, grade crossings which have given trouble are eliminated and a new station is built for the comfort of the citizens of Jonesburg, but the needs of the roundhouse are forgotten.

The difficulty of foreseeing what movements will have to be taken care of when a terminal is built often makes it advisable to change the arrangement of tracks after the weak points have been discovered, but there are many terminals operating to-day with insufficient track space, which necessitates extra movements and is a prolific source of trouble. At all but the smallest terminals there should be more than one track for locomotives entering the roundhouse and leaving the roundhouse. Too often but one track is provided for the movement in each direction and a great deal of time is wasted in switching movements. Since the federal inspection of locomotives has been in effect it has become specially important to determine the condition of the incoming locomotives as quickly as possible and a pit over which the locomotive must pass before being coaled is usually found to be the most satisfactory arrangement. Nevertheless at many roundhouses the locomotives are still inspected on the roundhouse pits. There is hardly an engine terminal where a close study would not disclose opportunities for doing work more economically.

On a large western road it recently became necessary to tear down an old engine house and a modern terminal was provided. The saving in wages effected by the new plant was at the rate of \$40,000 a year. There are many roundhouses now in operation which are quite as bad as the one which was torn down in this instance. It is not always possible to effect such marked economies, but in many cases changes can be made which will materially reduce the cost of operation. The roundhouse should not be regarded as a place to dump machine tools which cannot be used elsewhere, nor should the plant in general be neglected until it becomes

necessary to replace it. Roundhouses should have the best facilities for doing work which can be provided. The foreman who realizes the shortcomings of his plant and does not take energetic measures to correct them, fails in the duty which he owes to his superior officers and to the road.

The Valuation of Rolling Stock

In the valuation of cars and locomotives the Interstate Commerce Commission is using a method of determining the cost of reproduction less depreciation which may work a grave injustice to the railroads. The continual development of more efficient equipment has made it profitable in all branches of industry to retire old equipment before it has been completely worn out and to replace it with a more efficient type. So, as the weight and efficiency of locomotives and cars have increased, it has proved economical to discard old equipment after a comparatively short time. Practically all locomotives and cars are retired, not because they are actually worn out, but because of obsolescence; they will still run almost as well as ever, but nevertheless have become inadequate for the service, which is constantly growing more exacting. This is a *functional*, not a *structural* depreciation, and is not due to the depreciation of the individual parts of the equipment. The confusion of *functional* with *structural* depreciation has given rise to a common misconception which has had an influence on valuation practice and has resulted in errors in the methods employed.

The question of the amount of depreciation which actually exists in a plant is one upon which there is still great difference of opinion. Depreciation undoubtedly exists in the separate parts of the equipment and can be determined for each individual part. In setting the cost of reproduction of equipment less depreciation, the depreciation of the individual parts doubtless should be used; but in determining the amount which should be set aside from the net income for the replacement of obsolete equipment it is necessary to consider the functional, not the structural, depreciation.

The method used by the Interstate Commerce Commission in determining the amount of depreciation existing in locomotives and cars is based on the *functional* depreciation rate; the value of the equipment is found by ascertaining the probable life, based upon past experience, the result being modified according to the actual condition of the parts as ascertained by inspection. The whole method is based on the assumption that all the locomotives now in use in the United States will be retired at the average age at which locomotives have been retired in the past. This is a dangerous premise, as the working of obsolescence in the past affords no certain standard for determining how it will work in the future.

The fact is, there is very little physical deterioration in a locomotive or car until the end of its functional life is nearly reached. Its physical condition could be kept nearly unimpaired for an indefinite period, but as the time when it is to be retired approaches the amount spent for maintenance is reduced, and the equipment deteriorates more rapidly. A detailed examination of the effect of the depreciation of the parts on the value of the whole will make this clear. If we take the driving wheel tires as an example of the cycle through which all the parts of the locomotive pass, we will find that the curve of their value, starting at 100 per cent, decreases gradually but never reaches a point below the scrap value of the tires, which we might set at about 20 per cent of the original cost. If the tires are removed at the end of eight years and new ones substituted those parts are brought back to 100 per cent condition. If we consider another part, as, for instance, the boiler shell, we find its life to be, let us say, 25 years. Its value, then, decreases gradually from the time the locomotive is built until it becomes 25 years of age, when the value of the boiler becomes merely its salvage value or about 20 per cent of the

original cost. The tires will have been renewed one year prior to the time that the boiler is retired, and their value will be 90 per cent of the original value. It will be seen from this that the physical value of a locomotive does not decrease steadily until the end of the term of years after which the longest lived part must be renewed. Some parts do not depreciate at all and their value, even when the locomotive is retired, is still 100 per cent of the first cost. The effect of the difference in the life of the composite parts is to keep the physical value of the whole far above the scrap value until the end of the service life is reached.

Mr. Prouty has indicated that the cost of reproduction less depreciation will not be used as a basis for fixing rates. Nevertheless, it is to be hoped that the commission will see fit to modify the straight line depreciation which it has applied to locomotives and cars.

In a report to the St. Louis Public Utilities Commission made in 1912 James E. Allison said:

"To claim that investors have been reimbursed for depreciation by excess profits in the past is to deprive them of a part of their legitimate past profits to create a needless depreciation fund and is equivalent to regulating profits in the past by enactments today. This is an *ex post facto* proceeding and is inadmissible as a matter of law or as a matter of justice." The railroads paid 100 per cent for their properties, although the normal theoretical value may be less. They have not been allowed to earn the depreciation, and if the property is to be allowed to earn only on the remainder of its value the difference between the first cost and the depreciated value has been confiscated. If old locomotives had been kept in service, rates would be high and valuation would be low; the public would pay for inefficiency. The valuation of the present property, depreciated at the functional rate, if applied in rate making, will penalize the railroads for being progressive and efficient. Any statute which would make for inefficiency in the future would doubtless be condemned. The proposal to penalize the railroads by an *ex post facto* regulation for their efficiency in the past lacks even a semblance of justice.

NEW BOOKS

Fuel Association Proceedings. Edited by J. G. Crawford, secretary, Chicago, Burlington & Quincy, Chicago, Ill. 355 pages. Illustrated. 6 in. by 9 in. Bound in paper and leather. Published by the association. Price, paper bound, 50 cents; leather bound, \$1.

This is the official proceeding of the eighth annual convention of the International Railway Fuel Association, which was held at the Hotel Sherman, Chicago, Ill., May 15, 16, 17 and 18. It contains a thorough discussion on the following subjects: Powdered Coal, Storage Coal, Fuel Stations, Front End Grates and Ash Pans, Care of Locomotives with Relation to Fuel Economy, Coal Distribution Record System, the Functions of a Railroad Fuel Inspector, the Human Fireman, the Influence of an Intimate Knowledge of Coal on Fuel Economy on the Efforts of Engineers and Others, Interpretation of Coal Analysis With Special Reference to Non-Combustibles, What the Transportation Official can do to Promote Fuel Economy, and a paper by S. M. Felton, president, Chicago Great Western, on the Fuel Problem, Past and Present.

Preliminary Mathematics. By Prof. F. E. Austin. Bound in cloth; 170 pages; 5 in. by 7½ in. Published by Prof. F. E. Austin, Hanover, N. H. Price, \$1.20.

A book which will furnish a connecting link between arithmetic and algebra has been badly needed. Prof. Austin has tried to show the connection between the common operations of arithmetic and the corresponding algebraic processes so as to make it easy for the student to gain a practical knowledge of algebra and its application. From the simplest operations the author proceeds to the treatment of roots, logarithms, linear and quadratic equations and series and progressions.

COMMUNICATIONS

ALTERING LOCOMOTIVE FRONT ENDS

DOUGLAS, Ariz

TO THE EDITOR:

I was very much impressed with the editorial on page 220 of the May issue, under the heading "Altering Locomotive Front Ends." It is timely and to the point. However, it appears strange to me that you did not plant both feet firmly on the proposition instead of just stepping on it with one foot.

The true proportions of the front end draft appliances being once determined and proved, there should be no more occasion to alter them than to change the proportions of an injector designed to perform a certain work. The function of the exhaust nozzle, in conjunction with the stack, is simply to create, by means of the steam jet, the greatest possible vacuum in the front end without impairing the efficiency of the locomotive through excessive back pressure.

Tests have proved that the nozzle area can be accurately predicated on the cylinder volume, and that the ratios of nozzle opening and height, stack area and length can be positively determined. It may be necessary in some cases to extend the stack into the front end in order to get the length required, but this problem presents no mechanical difficulty.

The function of the diaphragm or deflecting plate is, as its name implies, to deflect or give direction to the current of gases passing through the tubes, while that of the draft sheet is to regulate the volume that can be emitted in a given period of time, so as to produce a practically even flow of gases through all tubes. In addition to this, the draft sheet also aids in so directing the current of gases that any cinders carried with this current impinge against the front end door at such an angle as to cause them to be broken up small enough to pass through the netting. In other words, the diaphragm plate and draft sheets act as a draft regulator or distributor and front end cleaner. As the position of these plates can be definitely determined by experiment, it follows that given a certain type of locomotive the position and dimensions of the various draft appliances can be arrived at with an experimental locomotive, and then be permanently adjusted on all of that type from the data obtained.

The desire to "monkey" with the front end arrangements is a survival of the day of the old diamond stack, long petticoat pipe, and personal ownership of the locomotive by the engineer and fireman, where each adjustment was made to suit the whim of the engine crew. In this day of pooled power, however, if the front end appliances were changed to suit the firing methods of every fireman, it would only result in continual adjustments without any definite results; whereas, if the position and dimensions of the various appliances are fixed to produce known results, it follows that in case of steam failures the real seat of the trouble will be located and corrected. This may be found in the firing method, in the manner in which the engine is handled, in steam losses due to defective cylinder packing, valve seats or rings, steam pipe or nozzle joints, or last but not least, insufficient air opening under the fire. Perhaps, on the whole, it would be advisable to begin our investigations and draft adjustments from the firebox end, as all do not appreciate the necessity of ample air openings to the ashpan and through the grates, the belief being prevalent in some parts that draft action or fire stimulation is somewhat similar to lifting a bale of hay with a grab hook, i. e., a pulling action, instead of realizing that draft action is due to difference in

atmospheric pressure above and below the fire, regardless of whether this difference is produced by decreasing the pressure above the fire by means of a partial vacuum as in the locomotive firebox, or by increasing the pressure below the fire through a forced air jet as is done in the blacksmith's forge.

The permanent adjustment of draft appliances is entirely practicable and feasible on all classes of locomotives. It has been done on this road, and is being done on the Pennsylvania System, and when the practice becomes more universal, another step in the matter of fuel economy will be a *fait accompli*; for so long as the fireman can with any degree of assurance attribute steam failures to a defect in draft adjustments, so long will a spirit of indifference dominate his firing methods, and indifferent workmanship in any occupation spells but one thing, waste.

F. P. ROESCH,
Master Mechanic, El Paso & Southwestern.

TOBESURA WENO "ON THE MAT"

(With Apologies to Wallace Irwin.)

DEAR EDITOR: I am writing you to warn of possible disappearance from view soon on account of discipline. I receive summons of late to report Big Chief at Washington. I hasten to comply and am greeted by full force U. S. Chief Detectors.

Hon. Assistant inquire if I am off or from. I place feet at proper angle according to secret code and emit—"loath, mister assistant, off my job and from my district."

"You know the rules," he assume softly?

"Yes, Hon. boss," I reply with tremble in voice.

"You are accuse of interfering with legislative matter, giving aid to brotherhood enemy, betraying secret of inspection job to corporation-own magazine (this refer to you) and writing letter to editor casting inflection on U. S. I. C. C. bureau."

I deny fact in totem, refer to insidious lobby and throw myself on mercy four leader which compose jury. I weep great salt tears like brotherhood chief when he demonstrate hard life rr trainmen and assume look of aggrieved angel. I drop on knee with hand outstretch and swear forever loyalty first to Hon. brotherhood, second to four chief, third to Hon. boss and last if any left to U. S. government. I suspect four chief with thumbs turn down which mean trouble for innocent detector. On order boss, I remain in suspense until jury award penalty.

While await verdict, I sadly walk street and conceive scheme to visit Hon. law manufacturers who distribute seed and pork-barrels, make headlight, safety appliance and eight-hour laws with bogus attached. During show I see courageous senator from Iowa filibust ten days to obstruct appointment of Hon. Daniels on I. C. C. board; I behold frenzy finance arrive from Boston arm with bombs and hearsay evidence for indicating Mr. President, Hon. brother-in-law and son-in-law for writing peace notes to Wall street; see Josephus Daniels (who rejuvenate navy) insult American patriots in steal plant by order shell from London and almost get deport for undesired spy account peacefully picket I. C. C. boarding house in super anxiety to hold job.

This suspense are bad on boiler, flue and tire and if I are not soon restated with honor, I propose last card to Chief by issue Form 5 on poor jap detector. This will affect boss as joke and maybe save job. I hope, hon. editor things have not arrive that pass where faithful and relentless persecution of heartless RR corporation lose honest worker job or reduce him to involuntary servitude. If Big Chief decide satisfactory, I are going to wireless you in secret code—so—IT ARE REPORTED THAT A GREAT FIRE ARE RAGING IN TORONTO.

Yours truly,

TOBESURA WENO.

PENNSYLVANIA LOCOMOTIVE TESTS

The Testing Plant of Great Value in the Determination of Correct Locomotive Proportions

BY ANDREW C. LOUDON

THE *Railway Mechanical Engineer* has frequently referred to the work that has been done on the Pennsylvania Railroad in the past few years in the way of locomotive development, but little has been published regarding the actual performance, in detail, of the locomotives as determined on the testing plant at Altoona. It is proposed, therefore, to give some account of the general performance of the three types which have so far been developed to a condition of economy and capacity which has warranted their building in considerable numbers. These types are the Atlantic (Pennsylvania Railroad class E6s), Pacific (class K4s) and Mikado (class L1s). The Atlantic type engine was described in the February, 1914, issue of the *Railway Age Gazette, Mechanical Edition*, and the other two in the issue of July, 1914. The results of the tests of the Pacific and Mikado types will be dealt with later. The figures given in this article are from Locomotive Testing Plant Bulletin No. 27 of the Pennsylvania Railroad, entitled "Tests of a Class E6s Locomotive." (Copyright 1915 by the Pennsylvania Railroad Company.)

The development of the most recent form of the Atlantic type locomotive on this road extended over a number of years and the testing plant at Altoona took a prominent part in it. In 1910 a locomotive of the E6 class using saturated steam was built. In 1912 this locomotive had a superheater added and its classification was changed to E6s. One more locomotive of the E6s class was built at this time and one class E6sa, differing from the others in having a special valve and valve gear. There were then two E6s and one E6sa locomotives; these had tubes 13 ft. 8 $\frac{5}{8}$ in. long and cylinders 22 in. by 26 in. In 1913 the three locomotives were rebuilt with new cylinders 23 $\frac{1}{2}$ in. by 26 in. and with other changes, but with no change in tube length. After June 1, 1913, a large number of locomotives of the E6s class with 15-ft. tubes were built, and one of these latter, No. 51, is the subject of this article. The E6 and E6sa classes no longer exist. There are now no locomotives like Nos. 89 and 5075, figures for which are given, in comparison with those obtained from No. 51, which is the finally adopted form of the E6s class.

The general dimensions of the two locomotives of the E6s class are as follows:

	Old E6s No. 89	New E6s No. 51
Total weight, working order, lb.	234,200	240,000
Weight on drivers, working order, lb.	141,000	133,100
Cylinders (simple, diam. and stroke, in.)	22 by 26	23 $\frac{1}{2}$ by 26
Driving wheels, diameter, in.	80	80
Heating surface, tube (water side), sq. ft.	2,404.9	2,634.5
Heating surface, firebox, including arch tubes, sq. ft.	254.5	232.7
Heating surface, superheater (fireside), sq. ft.	688.8	810.6
Heating surface, total (based on water side of tubes) including superheater, sq. ft.	3,348.2	3,677.8
Heating surface, total (based on fireside of tubes), including superheater, sq. ft.	3,689.5	3,405.6
Grate area, sq. ft.	55.23	55.79
Boiler pressure, lb. per sq. in.	205	205
Valves, type	14 in. piston Walschaert	12 in. piston Walschaert
Firebox type	Wide, Belpaire	Wide, Belpaire
Tubes, number and outside diameter	242—2 in.	242—2 in.
Flues, number and outside diameter	36—5 $\frac{1}{4}$ in.	36—5 $\frac{1}{8}$ in.
Tubes and flues, length, in.	164.63	179.71

Both locomotives were equipped with brick arches.

Experiment has shown that there is a point beyond which the lengthening of the tubes fails to produce a proportional increase in evaporation, the effect being partly due to the resistance to the flow of gases and the retardation of combustion. But for best results the tubes should be extended fully up to the point where the increase in evaporation ceases to be propor-

tional to the increase in length. It has been found on the Pennsylvania that the most desirable length for a tube is about 100 times its internal diameter and this rule has been adopted with a leeway to the designer of 10 or 15 per cent to satisfy other boiler conditions. In the first E6 boiler the tubes had a ratio of length to internal diameter of 94; in the new boiler, with 15-ft. tubes, the ratio is 103.

It will be noted that the final form of the E6s locomotive uses a 12-in. diameter piston valve, while the original engine had 14-in. valves. It has been found that this is entirely practicable from the fact that superheated steam flows through the steam passages with greater freedom than saturated steam of the same pressure, making it possible to restrict the passages to some extent. The entire design of piston valve and valve gear has been completely revised, the gear being much lighter and at the same time giving greater rigidity. The new form of valve is shown in Fig. 1.

The reciprocating parts of this latest engine are remarkable for their light weight, and in spite of the fact that the maximum weight on a pair of drivers is now 67,000 lb. the dynamic augment or the increased pressure on the rail due to the unbalanced revolving weights at 70 miles an

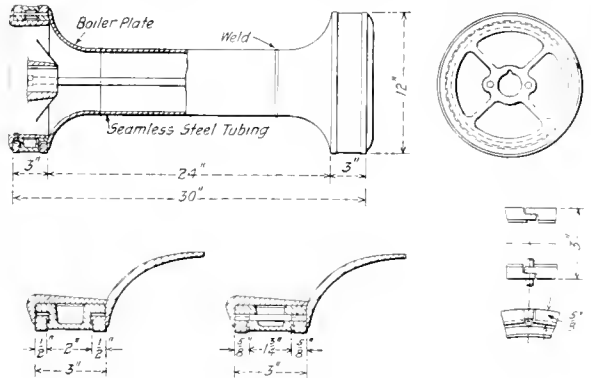

Fig. 1—Piston Valve Used in the Class E6s Locomotives

hour, is less than 30 per cent of the static weight on the drivers; or no greater than that with many locomotives having from 10,000 to 12,000 lb. less weight per axle, but with heavy reciprocating parts. The great care in the design of these reciprocating parts has made possible a locomotive of this type which is more powerful than many locomotives of the Pacific type, while it has less destructive action on the track. The light weight of the reciprocating parts of this and other Pennsylvania Railroad locomotives is shown clearly in a series of articles by H. A. F. Campbell in the *Railway Age Gazette, Mechanical Edition*, for March, April, May and September, 1915.

BOILER PERFORMANCE

The coal used in the tests of No. 51 was the same as that used with No. 89, being bituminous from Westmoreland county with 58.45 per cent carbon, 33.65 per cent volatile matter, 1.54 per cent moisture and 6.36 per cent ash, the sulphur, separately determined being 1.62 per cent. This fuel has a heat value of 14,470 B. t. u. per lb., dry, and 14,513 B. t. u. per lb. of combustible.

The exhaust nozzle used in No. 51 was of a type devel-

oped on the Pennsylvania and now in general use on that road. It has four internal projections or partial bridges. These break up the continuity of the stream from the nozzle to a certain extent, which has proved advantageous. This nozzle was described in the *Railway Age Gazette, Mechanical Edition*, for April 1915. One of these nozzles, with an area of 30.68 sq. in., or equivalent to a 6.25-in. diameter circular nozzle, gave the highest actual evaporation, 44,628 lb. of water per hour. A similar nozzle with an area of 27.06 sq. in. produced a maximum evaporation of 42,420 lb. per hour at a speed of 240 r.p.m. with a cut-off of 45 per cent. The maximum evaporation of 44,628 lb. was at a rate of 5.4 lb. of water per lb. of coal, or an equivalent evaporation of 7.09 lb. of water per lb. of dry coal, the superheat being 204 deg. and the boiler efficiency 48.59 per cent.

After a few tests of No. 51 it was found that the smokebox was not cleaning properly. The pocket in the diaphragm plate around the nozzle was made of a solid plate instead of netting, and an extension was made at the forward end of the diaphragm plate. This corrected the smokebox trouble. The following table shows the smokebox draft:

Pounds of water evaporated Per hour, actual	Draft in smokebox, in. of water			
	Right side	Left side	Top	Bottom
15,492	1.5	1.5	1.4	1.1
20,200	2.1	2.1	2.1	2.2
24,645	3.2	3.3	3.1	3.1
30,008	4.3	4.2	4.0	3.4
35,238	5.8	5.7	5.6	...
40,063	8.1	7.8	7.7	8.5
44,628	9.6	9.3	9.3	10.1

In front of the diaphragm the draft increased to 15.1 in. of water when the rate of firing reached 150.56 lb. of coal

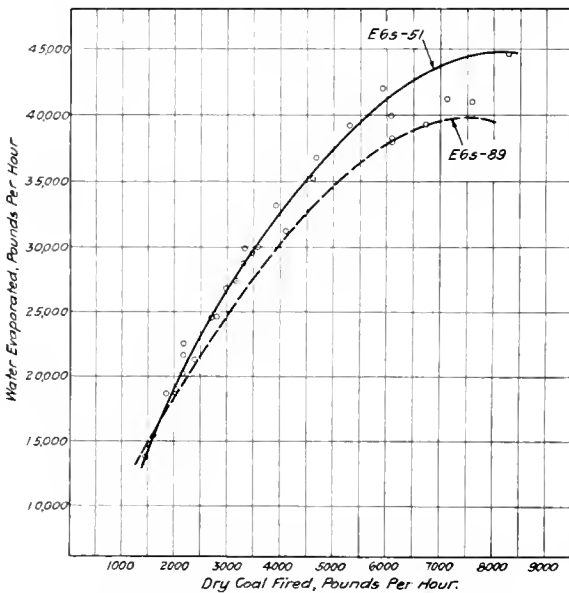

Fig. 2—Relation of Dry Coal Fired to Water Evaporated

per sq. ft. of grate per hour; the draft back of the diaphragm was 9.4 in.; in the firebox 3.5 in. and in the ashpan 0.40 in.

The vacuum in the ashpan is somewhat higher than that obtained with No. 89. At a speed of 200 r.p.m. and 50 per cent cut-off, the rate of combustion for No. 51 was 148.25 lb. of coal per sq. ft. of grate per hour and the vacuum in the ashpan was 0.40 in., while No. 89 burned 142.17 lb. of coal per sq. ft. of grate per hour with 0.15 in. vacuum. The area of the air inlets to the ashpan of No. 89 was 8.1 sq. ft., or 14.6 per cent of the total grate area. On locomotive No. 51 the corresponding figures are 7.85 sq. ft., or 14 per cent. That the longer boiler tubes absorb more heat was indi-

cated by slightly lower smokebox temperatures in No. 51 than in No. 89. In the new engine the temperatures ranged between 436 and 663 deg. F., being always below 700 deg. F., while in No. 89 the smokebox temperature reached as high as 770 deg. F.

The dry coal fired per hour ranged between 1,477 and 8,271 lb., and the rate of combustion per sq. ft. of grate per hour from 26.47 lb. to 148.25 lb. Based on a square foot of heating surface it ranged between 0.434 and 2.429 lb. The heat absorbed by the superheater ranged from 6 to 9.5 per cent, or less than 10 per cent of that absorbed by the water heating surfaces. The combustion rate increased regularly with the draft up to a rate of firing of approximately 148 lb. of dry coal per hour per sq. ft. of grate, when the maximum draft obtained was 15 in. of water. The indications

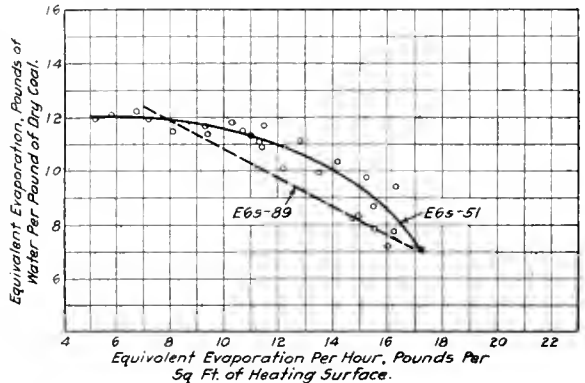

Fig. 3—Equivalent Evaporation per Pound of Dry Coal

were that with a further material increase in the rate of firing the draft would have been insufficient to promote good combustion. At the maximum rate of combustion, the distribution of the draft was 20 per cent in drawing air through the fuel bed, 40 per cent in moving the gases through the tubes and 37 per cent in drawing the gases from the back to the front of the diaphragm. The corresponding figures for No. 89 were 18.3 per cent from ashpan to firebox, 29.5 per cent from firebox to back of diaphragm, and 51 per cent from back to front of diaphragm. It is again evident that the lengthening of the tubes has proved advantageous, but locomotive No. 51 might have been the better for an increased ashpan air opening.

With an increase of heating surface over No. 89 of 10 per cent, No. 51 increased the maximum evaporation 15 per cent, or from 38,846 lb. per hour to 44,600 lb. per hour. This is shown by the curves in Fig. 2.

The boiler efficiency shows substantial improvement, ranging in the case of No. 51 between a figure of about 83 per cent at an evaporation rate of 18,000 lb. per hour, and slightly below 50 per cent at about 44,000 lb. per hour. As the curves for the two engines do not follow the same form, it is difficult to obtain exact figures of general comparison. However, plotting the boiler efficiency of the two locomotives on a base of dry coal per hour per sq. ft. of grate, the curves for both engines are straight lines and are parallel, the efficiency for No. 51 being about 9 per cent above that of No. 89. At a rate of about 40 lb. of dry coal per hour per sq. ft. of grate, the efficiency of the boiler of No. 51 is in the neighborhood of 83 per cent, dropping to about 50 per cent at 140 lb. per hour. The equivalent evaporation per lb. of coal is about 9 per cent greater for No. 51 than for No. 89, the range for No. 51 being between 12.5 lb. per lb. of dry coal at about 35 lb. of dry coal per hour per sq. ft. of grate and 7 lb. at a rate of 150 lb. of coal per hour.

Fig. 3 shows comparisons between the evaporations per lb. of coal at all rates of evaporation. This again shows im-

proved results for No. 51 up to the maximum rate, where the two lines meet. The maximum rate of equivalent evaporation for No. 51 is 17.22 lb. per sq. ft. of heating surface per hour.

The maximum superheat obtained with No. 51 was 12.5 deg. above that obtained from the short tube boiler of No. 89, the range in superheat in the case of No. 51 being between 137 and 251.3 deg. F.

The shorter tube boiler showed a greater activity of com-

steam rate per i.h.p. hour ranged between 16.07 and 20.56 lb. The maximum steam temperature reached (in the branch pipe) was 635.7 deg. F., or 251.3 deg. F. of superheat. The superheat in general was below 230 deg. F., there being little difference in the superheat obtained in No. 51 and No. 89. In neither case was the superheat below 137 deg. F.

The steam consumption per indicated horsepower hour is much the same for both No. 51 and No. 89 up to about 1,800 i.h.p., beyond which the rate for No. 51 rises slightly. However, under what may be considered normal working conditions, or between 1,200 and 2,000 i.h.p., the rate of water consumption of No. 51 is very satisfactory. The coal per i.h.p. hour is lower for No. 51 than for No. 89 at all rates, due to the better boiler performance. This is shown in Fig. 4, and the water rate in Fig. 5. At horsepowers above 1,800, the tests of locomotive No. 51 show that the larger cylinders use slightly more steam than the cylinders of No. 89, but considering the coal rate and the increased boiler efficiency, the locomotive as a whole shows considerable improvement.

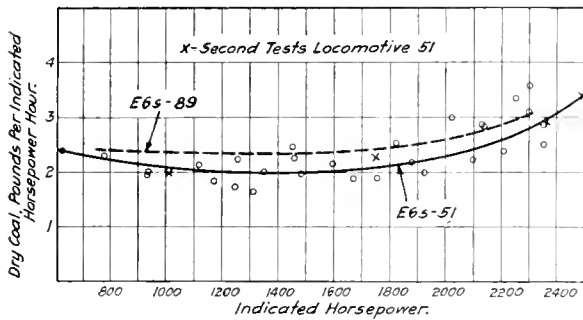

Fig. 4—Coal Rate and Indicated Horsepower

bustion for like drafts, but there was very little difference in the rapidity of evaporation in the two boilers until a draft of five inches of water was obtained back of the diaphragm. The shorter tube boiler then showed a more rapid rate until its evaporation limit was reached.

ENGINE PERFORMANCE

The efficiency tests made with No. 51 on the testing plant were at speeds between 28.1 miles per hour (120 r.p.m.) and 84.4 miles per hour (360 r.p.m.), the nominal cut-offs being between 15 and 50 per cent.

At a speed of 28.1 m.p.h., and 15 per cent cut-off, the indicated horsepower was 620.3, while at 75 miles per hour and 35 per cent cut-off it was 2,357.2. In a second series of tests the indicated horsepower reached 2,488.9, or a horse-

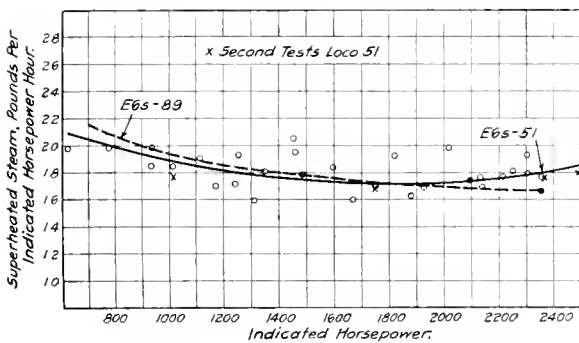

Fig. 5—Relation of the Water Rate to Indicated Horsepower

power for each 96.5 lb. of total weight. The following tables give the figures for the two series of tests:

FIRST TESTS, JUNE AND JULY, 1914

Boiler pressure	Superheat, deg. F.	Steam to engines, lb. per hour	Indicated horsepower	Dry coal per i.h.p. hour, lb.	Steam per i.h.p. hour, lb.
206.0	145.6	18,627	1,011.7	2.0	18.4
202.6	246.7	41,208	2,302.1	3.1	17.9
204.9	204.2	44,530	2,304.8	3.6	19.3
206.0	216.0	41,631	2,357.2	2.5	17.7

SECOND TESTS, DECEMBER, 1914

205.0	139.8	17,826	1,015.8	2.0	17.6
204.5	179.6	41,986	2,366.3	2.9	17.7
201.7	228.3	44,583	2,488.9	3.4	17.9

The coal rate per indicated horsepower hour did not exceed 3.6 lb. in the first tests, and with the exception of four tests the coal consumption was below 2.9 lb. per i.h.p. hour. The

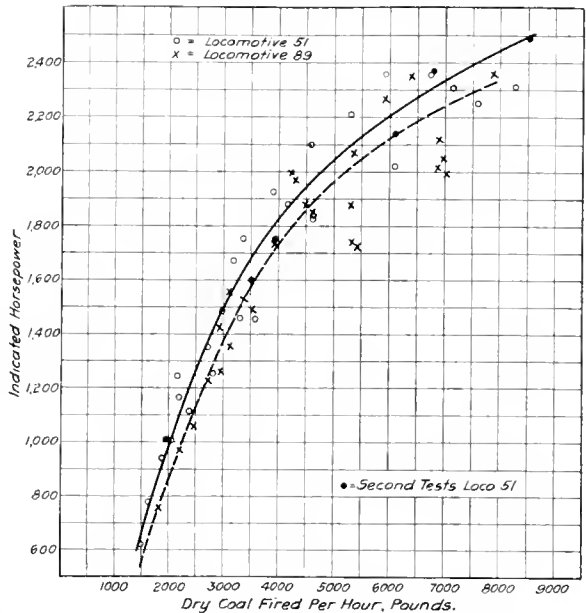

Fig. 6—Coal Fired and Indicated Horsepower

Attention is called to the fact that with No. 89, the maximum indicated horsepower obtained was 2,355.2 at a speed of 360 r.p.m. or 84 m.p.h., and a cut-off of 36.1 per cent.

The curves in Fig. 6 show that No. 51 develops a greater horsepower than No. 89 at every rate of firing.

A single curve fairly represents both locomotives when steam per i.h.p. hour is used as a base for plotting piston speed. Such a curve shows an improvement in steam consumption with an increase in piston speed up to 1,200 ft. per minute. The rate falls from about 20 lb. at 500 ft. per minute, to 17 lb. at 1,200 ft. per minute.

Considering the efficiency of the engines, and taking the Rankine cycle as a base for an ideal engine, it is found that such an engine has an efficiency of 33.67 per cent. Considering this as 100 per cent, the actual engines developed an efficiency which was 67.8 per cent of the ideal. While from 11.6 to 14.1 per cent of the actual heat in the steam was turned into work (thermal efficiency), the engines approached within 33 per cent of the perfect engine. As the power increases there is an increase in the thermal efficiency which decreases again at maximum power. With an indicated horsepower output between 600 and 2,400, the actual engines of these locomotives use from 11 to 14 per cent of the heat in

the steam and discharge the rest to the exhaust. If the ideal engine could replace the actual engine, it could perform the same functions under identical conditions with approximately 60 per cent of the actual engine's steam consumption. As the rate of steam consumption decreases, with increased speed and shortened cut-off, this loss of power becomes less and the performance of the actual engine approaches that of the ideal as a limit.

For locomotive No. 89 the efficiency reached 86.5 per cent of the ideal. This was at about 85 miles per hour. The large amount of heat rejected in the exhaust (from 86 to 89

Steam per i. hp. hour, lb.	17.70	18.86	24.14
Indicated horsepower	2,131	2,016	1,546
Mean effective pressure, lb.	95.97	104.1	79.0
Cut-off, per cent of stroke	45	55	32
Superheat, deg. F.	245.6	237.0	None

The following tables give the results of tests for determining the performance of locomotive No. 51 at the drawbar:

FIRST TESTS, JUNE AND JULY, 1914					
Speed, miles per hour	Drawbar pull, lb.	Dynamometer horsepower	Coal per d. hp. hour, lb.	Steam per d. hp. hr., lb.	Mach. efficy of loco., per cent
56.4	13,691	2,060.2	3.5	20.0	89.5
56.4	5,201	782.6	2.6	23.8	77.4
46.9	17,293	2,162.3	3.8	20.6	93.8
73.0	10,129	2,126.4	2.9	20.5	86.0
SECOND TEST, DECEMBER, 1914					
55.7	4,819	716.4	2.8	24.9	70.5
55.7	14,297	2,125.3	3.2	19.8	89.8
55.7	15,138	2,250.4	3.8	19.8	90.4

The maximum drawbar or dynamometer horsepower obtained was 2250.4, with a coal rate of 3.8 lb. per dynamometer horsepower hour and a steam rate of 19.8 lb. per dynamometer horsepower hour and a steam rate of 19.8 lb. The coal rate for all tests was generally below 3 lb. Locomotive No. 51 developed a maximum dynamometer horsepower about 17 per cent greater than that of No. 89. The machine efficiency ranged between 59.3 and 96.2 per cent, being higher for locomotive No. 51 than for No. 89. The thermal efficiency ranged between 3.8 and 7.8 per cent, being higher for

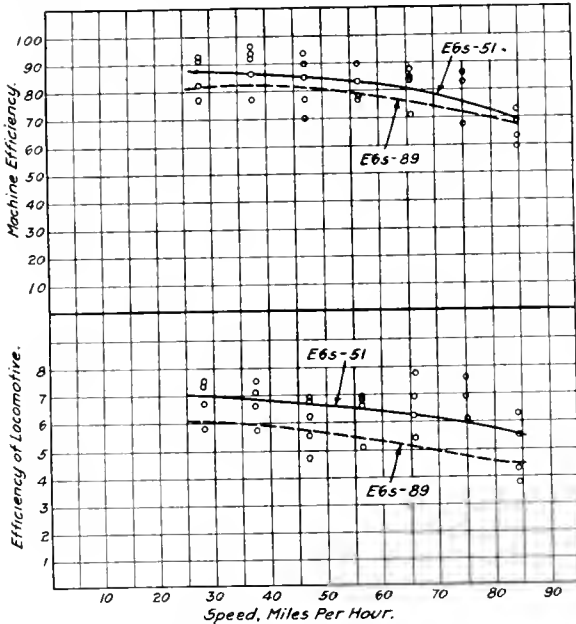

Fig. 7—Machine and Locomotive Efficiency Curves

per cent) is indicative of the further saving possible by the use of a feedwater heater on locomotives using superheated steam. But the actual value of the superheater is conclusively shown in the table, which gives the comparative performance at equal weights of steam, and at a speed of 48 miles per hour, for three locomotives, No. 51, No. 89, and No. 5075, the latter the class Eo engine, using saturated steam. This engine had cylinders 22 in. in diameter, the same as those

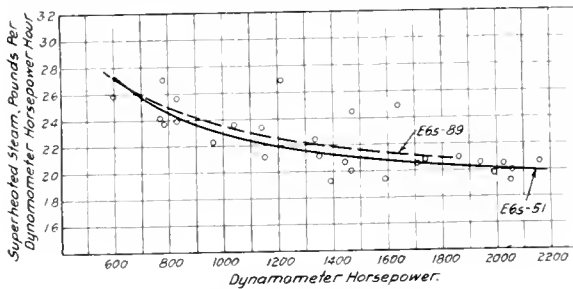

Fig. 8—Steam Consumption per Dynamometer Horsepower-Hour

of No. 89. Not only is greater power possible, but the advantage of a shorter cut-off is available over a greater range when the diameter of the superheater locomotive cylinder is increased above the limitations established by the use of saturated steam.

Locomotive No.	51	89	5075
Class	E 6-s	E 6-s	F 6
Steam per hour, lb.	37,713	38,028	37,355

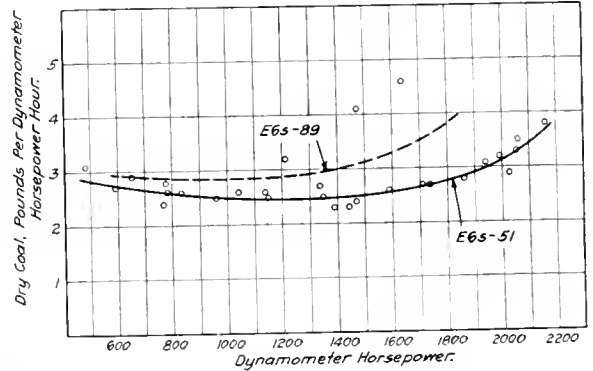

Fig. 9—Dry Coal per Dynamometer Horsepower-Hour

meter horsepower hour and a steam rate of 19.8 lb. The coal rate for all tests was generally below 3 lb. Locomotive No. 51 developed a maximum dynamometer horsepower about 17 per cent greater than that of No. 89. The machine efficiency ranged between 59.3 and 96.2 per cent, being higher for locomotive No. 51 than for No. 89. The thermal efficiency ranged between 3.8 and 7.8 per cent, being higher for

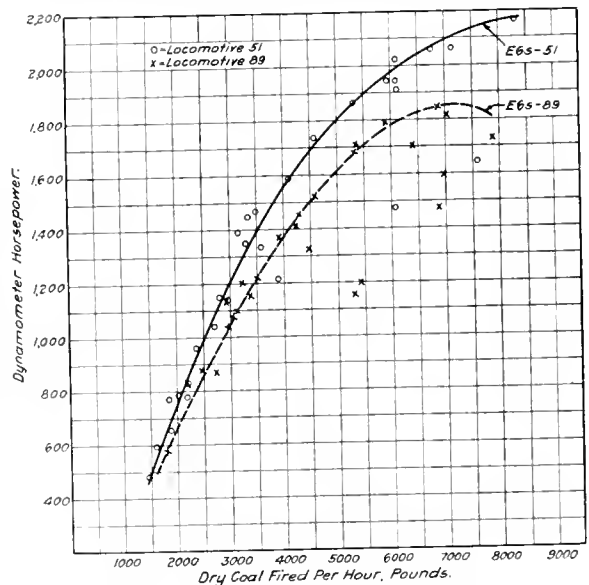
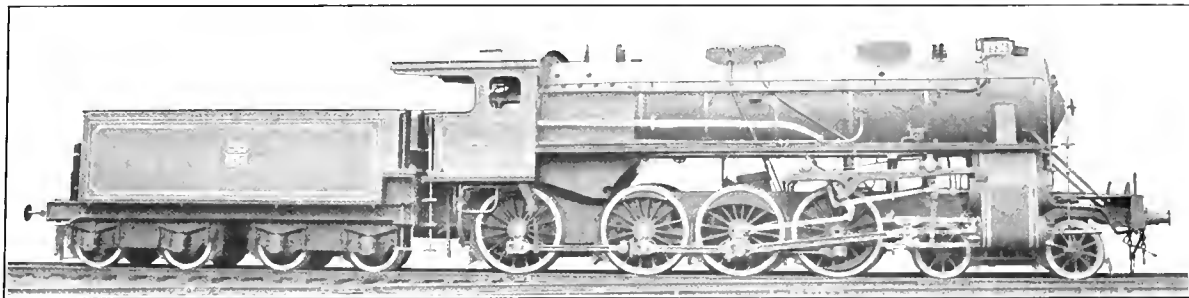

Fig. 10—Relation of Dynamometer Horsepower to the Rate of Firing

efficiency ranged between 59.3 and 96.2 per cent, being higher for locomotive No. 51 than for No. 89. The thermal efficiency ranged between 3.8 and 7.8 per cent, being higher for



SPANISH PASSENGER LOCOMOTIVES

American Built, Balanced Compound, 12-Wheel Engines for the Madrid, Zaragoza & Alicante Railway

AMONG the locomotives built for export by the American Locomotive Company during the past year is an order of twenty-five 4-8-0 type locomotives for the Madrid, Zaragoza & Alicante Railway of Spain. These engines were built strictly in accordance with specifications and drawings furnished by the railway company, all the dimensions being given in the metric system, which the workmen used direct.

The Madrid, Zaragoza & Alicante is one of the two largest railways in Spain and connects Madrid, Zaragoza, Alicante, Barcelona, Valencia, Cordova and Seville. The locomotives are duplicates of others used on this road which were built in Germany. They were designed to haul a load of 280 tons back of the tender at a speed of 50 km. (31 miles) per hour on 15-mm. grades (.015 per cent) over curves of 400 meters (1,312 ft.) radius; a load of 310 tons at a speed of 60 km. (37.28 miles) per hour on 10-mm. grades (.01 per cent)

the cylinder walls toward the center, instead of outward, the cylinders thus being partially closed at the rear ends. The cylinder heads are bolted to the inside face of these flanges, being applied from the inside of the cylinders. On the outer face of each cylinder head, which extends through the opening in the end of the cylinder, is cast the lug which supports the guide bar.

The steam distribution is controlled by one piston valve on each side of the engine, driven by one set of Walschaert valve gear. The ends of each piston valve are 17.32 in. in diameter while the middle portion, which controls the distribution to the high pressure cylinder, is 12.6 in. in diameter. The use of this type of valve is not unusual in European practice. The valve motion is reversed by a screw gear which does not differ essentially in its design from American practice.

The main frames are of steel plate 1.1 in. thick, with

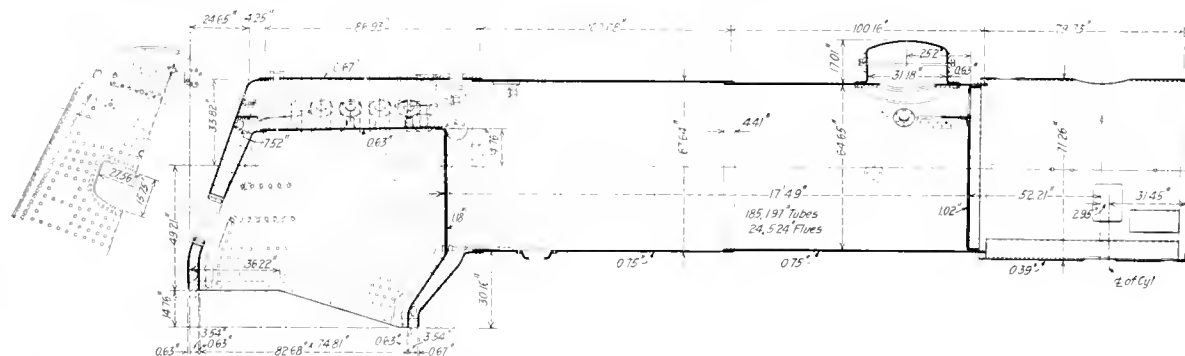

Sectional Elevation of the Boiler

over curves of 400 meters radius; and a load of 340 tons at a speed of 100 km. (62.13 miles) per hour on level track over curves of 700 meters (2,297 ft.) radius.

The engines are of the four-cylinder, balanced compound type. The low pressure cylinders are placed between the frames and drive on the cranked axle of the leading pair of driving wheels, while the high pressure cylinders are outside the frames and are connected with the second pair of driving wheels.

The high and low pressure cylinders on each side of the engine are cast integral with the half-saddle. The low pressure cylinders are raised and inclined to permit the removal of the pistons and the construction is somewhat different from that used in American practice. It will be seen on the elevation drawing of the locomotive that the flanges to which the rear low pressure cylinder heads are bolted, extends in from

front rails of soft steel 3.94 in. thick. The front bumper and deck are also of steel plate. All the axles are of forged steel, the crank axle being a single forging of basic open hearth steel having specified tensile strength limits of 78,227 lb. per sq. in. and 92,450 lb. per sq. in. and an elongation of not less than 18 per cent in about 6 in. Under-hung springs are used, this arrangement being better adapted to plate frame construction.

Contrary to American practice, these engines have what may be called a five point system of equalization. The front truck, first two pairs of driving wheels, and the last two pairs of driving wheels are each equalized in a separate system. There is no cross equalization. The desired weight distribution is obtained by means of adjustable spring hangers. The front end of the engine is carried on a four-wheel truck of the railway company's design, the load being transferred

stay in the next row back. A sleeve of 1½-in. pipe is placed between this block and the crown sheet. Part of the load carried by the crown bar bolts is thus transmitted to the first row of through crown stays. The water leg is closed at the door opening with a cast steel door ring to which are riveted the copper door sheet and the steel back head sheet.

The principal dimensions and proportions are as follows:

<i>General Data</i>	
Gage	5 ft. 6 in.
Service	Passenger
Fuel	Bit. coal
Tractive effort, simple	35,500 lb.
Tractive effort, compound	29,550 lb.
Weight in working order	129,000 lb.
Weight on drivers	136,900 lb.
Weight on leading truck	56,000 lb.
Weight of engine and tender in working order	215,900 lb.
Wheel base, driving	18 ft. 8½ in.
Wheel base, total	31 ft. 9½ in.
Wheel base, engine and tender	58 ft. 2½ in.
<i>Reps</i>	
Weight on drivers ÷ tractive effort, simple	3.9
Weight on drivers ÷ tractive effort, compound	4.6
Total weight ÷ tractive effort, compound	6.5
Tractive effort × diam. drivers ÷ equivalent heating surface*	593.3
Equivalent heating surface* ÷ grate area	73.1
Firebox heating surface ÷ equivalent heating surface*	3.1
Weight on drivers ÷ equivalent heating surface*	43.5
Total weight ÷ equivalent heating surface*	61.3
Volume equivalent simple cylinders	9.3 cu. ft.
Equivalent heating surface* ÷ vol. cylinders	338.2
Grate area ÷ vol. cylinders	4.6
<i>Cylinders</i>	
Kind	Compound
Diameter and stroke	16.54 in. and 28.2 in. by 25.59 in.
<i>Trucks</i>	
Kind	Pushon
<i>Wheels</i>	
Driving, diameter over tires	63 in.
Driving, thickness of tires	3 in.
Driving journals, front diameter and length	8.86 in. by 9.06 in.
Driving journals, fourth diameter and length	7.87 in. by 9.84 in.
Driving journals, others, diameter and length	7.87 in. by 9.06 in.
Engine truck wheels, diameter	38.3 in.
Engine truck journals, diameter	6.3 in. by 11.81 in.
<i>Boiler</i>	
Style	Straight top
Working pressure	213.4 lb. per sq. in.
Outside diameter of first ring	66½ in.
Firebox length and width	8.25 in. by 7.94 in.
Firebox plates, thickness	Crown, sides and back, 1.3 in.;
	tube, .63 in., 1.18 in.
Firebox, water space	front and back, 3.34 in.; sides, 2.76 in.
Tubes, number and outside diameter	185—1.97 in.
Flues, number and outside diameter	24—5.24 in.
Tubes and flues, length	17 ft. 4.9 in.
Heating surface, tubes and flues	2,333.5 sq. ft.
Heating surface, firebox	161.5 sq. ft.
Heating surface, total	2,395.0 sq. ft.
Superheater heating surface	500.0 sq. ft.
Equivalent heating surface*	3,145.0 sq. ft.
Grate area	43 sq. ft.
<i>Tender</i>	
Tank	Water bottom
Frame	Channel
Wheels, diameter	38.3 in.
Journals, diameter and length	5.12 in. by 10.04 in.
Water capacity	6,600 gal.
Coal capacity	67 tons

*Equivalent heating surface = total evaporative heating surface ÷ 1.5 times the superheating surface.

ELECTRIC LOCOMOTIVE OPERATION

At the March meeting of the New York Railroad Club, C. H. Quinn, chief electrical engineer of the Norfolk & Western, gave a few facts relative to the performance of electric locomotives in contrast to steam locomotives on that road. The electrified portion of the Norfolk & Western extends from Bluefield, W. Va., to Vivian, a distance of about 50 miles. The grades on the line are heavy, varying from one per cent at the west end, to one and a half and two per cent about ten miles from the west end.

When electric operation was started in January, 1914, the speed of the tonnage trains up the grade was increased from 7 to 14 m.p.h. The traffic through the Elkhorn tunnel, which is at the top of the grade above mentioned, was greatly expedited. This tunnel is about 2½ miles long. It has been found that the electrically handled coal trains can keep out of the way of any steam movements in the same direction on the grade with the exception of two through passenger trains. Further than this the absence of delays incident to the taking on of coal and water for three steam locomotives which were

previously required to handle the trains has not only materially reduced the running time, but has cut out delays to other trains.

The trains handled by electric locomotives are braked by what is called the regenerative braking system. This means that the motors of the electric locomotives are transformed into dynamos, thus absorbing the power given up by the heavy train while descending the grade and generating it into electricity, pumping it back into the line. This has practically eliminated the use of the air brake for governing train movements down the grade. The elimination of broken knuckles, train-breaking in two and other incidental delays due to difficulties with the air brake equipment on long trains, are some of the benefits obtained by regenerative braking.

The improvement in the movement of coal tonnage trains has resulted in a marked reduction in the time required to get these trains over the road. Under steam operation, the average miles per day would approximate 60 per locomotive. This mileage, with the electric locomotive, has been increased to 100, with only a slight increase in time in service per day for the engine crew. The short terminal layover for the electric locomotives, which averages 45 minutes per locomotive, practically permits double crewing these locomotives every 24 hours. As a direct result, the number of locomotives handled out of Bluefield has been reduced from 17 steam to 5 electric. The number of pusher engines has been reduced from 7 steam locomotives to 2 electric locomotives.

Electric locomotives during zero weather operate at practically full tonnage rating, while the steam engine always requires a tonnage reduction in cold weather. Further than this, the terminal attention and terminal equipment required for the electric locomotive is conspicuously less than that needed to take care of steam power.

The maximum eastbound tonnage for any 24-hour day handled by steam locomotives amounted to 51,226 gross tons; by electric locomotives, 59,543 gross tons, or an increase of 16 per cent. The maximum number of loaded eastbound cars per day handled under steam operation amounted to 675; with electric locomotives, 757 cars. The maximum number of locomotives in use to handle the heaviest day under steam operation was 43; with electric operation, 9. The total number of loaded cars handled eastbound during the year 1914, under steam operation, amounted to 132,618, while in 1916, with electric operation, the number was 165,689, an increase of 33.071. This shows a 25 per cent increase.

To handle the business with steam locomotives during the year 1914, as covered by the above figures, required a total of 93,625 engine-hours. To handle 25 per cent more traffic in 1916 with electric locomotives required a total of 44,112 engine-hours, a reduction of 48 per cent.

The field of activity of the electric locomotives should naturally be confined to sections of the road where the profile and tonnage handled will permit the economical use of this type of motive power. There are other sections of the road where the maximum possibilities of the steam locomotive have not as yet been reached, and where they are still able to be operated as economically as compared with the returns from an investment which would be represented by the use of the electric locomotive. With the commercial value of the steam locomotive well understood under such conditions, the next development in this direction will probably be the design and building of a Mallet locomotive with a tractive effort of approximately 104,000 lb. for use in main line service over 100-mile divisions of the road.

The use of electric locomotives in congested sections of the railroad, for the movement of heavy tonnage over grades requiring pusher service, is here to stay, and its extended use in this class of service will be general in the not very distant future.

MOUNT UNION COLLISION

A rear collision of eastbound trains on the Pennsylvania Railroad at Mount Union, Pa., occurred on the morning of February 27. A passenger train standing at the station was run into by a fast freight, consisting of a consolidation engine, Class H 9s, weighing 251,000 lb., thirty-five cars and a caboose.

The behavior of the steel cars in the passenger train is indicated by the illustration. It is remarkable that greater damage was not done. The weight of the freight train was estimated to be about 1,000 tons and its speed at about 40 m. p. h. when it struck the passenger train, which was standing on a tangent. The underframe of the rear car of the passenger train, the Bellwood, was wedged in between the front frame and the smokebox of the engine of the freight train, butting against the cylinder saddle. The rear end of the Bellwood seems thus to have been raised sufficiently to allow the front end of its underframe to pass underneath that of the car ahead of it, the Bruceville. This permitted the underframe of the Bruceville to split open the superstructure

PULVERIZED COAL PLANT FOR THE SANTA FE

Preparatory to testing the value of powdered coal as a locomotive fuel, the Atchison, Topeka & Santa Fe has had built at Marceline, Mo., by the Fuller Engineering Company, Allentown, Pa., a complete plant for pulverizing and drying the coal. Test runs are to be made in freight service between Marceline and Shopton, Iowa, a distance of 115 miles. A similar plant is to be erected at the latter point. Two Mikado locomotives are to be used for burning the pulverized fuel, one of which has been equipped with the apparatus of the Fuller Engineering Company, and the other is to be equipped with the apparatus of the Locomotive Pulverized Fuel Company. These locomotives have a total weight of 283,700 lb., 25-in. by 32-in. cylinders, a total heating surface of 4,111 sq. ft., a superheating surface of 880 sq. ft., making a total equivalent heating surface of 5,431 sq. ft. They operate at 200 lb. boiler pressure, and have a rated tractive effort of 59,600 lb.

An interior and exterior view of the pulverizing plant is

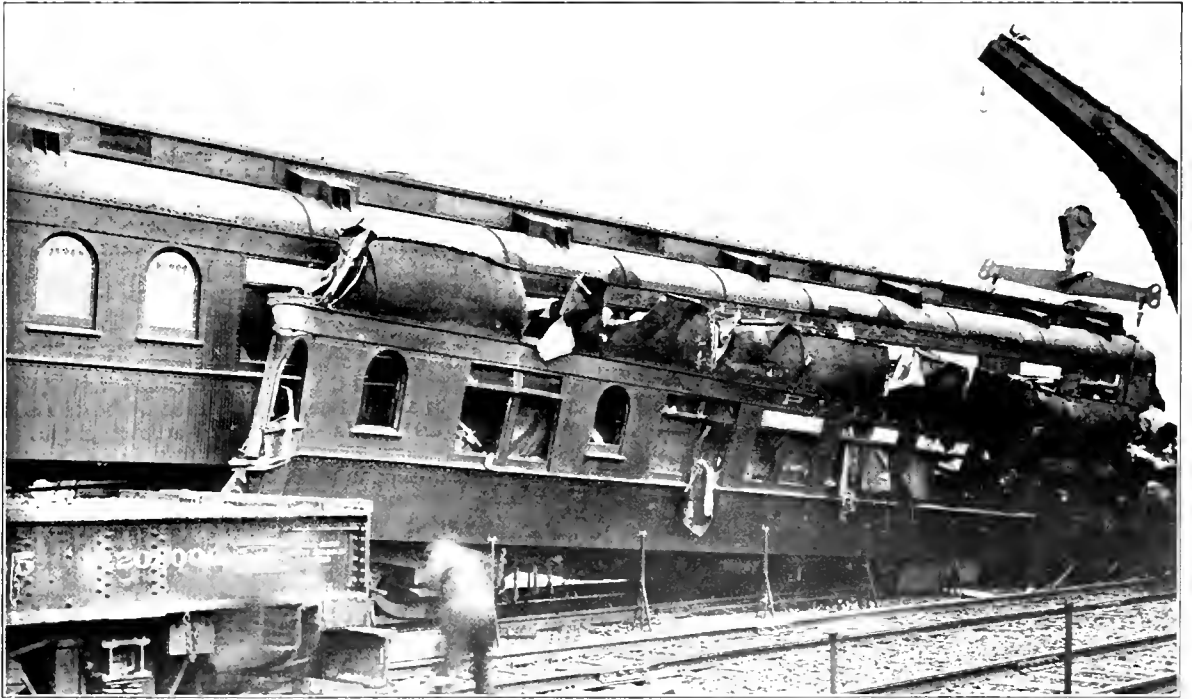

The Rear Car, Split Open and Telescoped by the Car Ahead

of the Bellwood, causing the death of 20 persons. There were no persons injured in the Bruceville and the damage to the superstructure of the car was slight, but few windows being broken. The whole train of eight steel cars and one engine was pushed forward about 200 ft.

The locomotive of the freight train was but slightly injured. The front end was crushed in and the cylinder saddle punctured by the underframe of the Bellwood. Only one pair of drivers left the rails. The tender and the first two freight cars buckled and were derailed. The freight cars were completely demolished and fell down the embankment at the side of the track. The tender cistern broke loose from its frame and rolled down the embankment also. Needless to say, had the passenger cars been of the old wooden construction, far greater damage and loss of life would have occurred.

shown in the illustrations. The capacity of this plant is dependent upon the output of the pulverizer, which is from 1½ to 2½ tons per hour. The coal used is Marceline screenings, which consists of 4.8 per cent moisture, 35.6 per cent volatile, 44.6 per cent fixed carbon, and 15 per cent ash. The coal is brought in from the mines and unloaded directly from the cars into a receiving hopper so arranged that it will feed directly into an elevator. This elevator discharges the coal into a storage bin having 11½ tons capacity. This is located above the coal dryer. A cradle or shaking type feeder is attached to the bottom of this bin to give a uniform supply of coal to the dryer. This dryer is shown at the left of the interior view. It consists of an inclined shell fitted with two tires mounted on rollers, and is driven by means of gearing. It is 3½ ft. in diameter and 42 ft. long, being fitted with the necessary stack mounted on a brick housing at the feed

end. The coal is fed in at the upper end and by the rotating action of the drier it is gradually carried through the shell to the discharge end. Surrounding part of the drier shell is a large brick housing equipped with grates. The gases of combustion surround the shell and pass down through a smoke connection to the housing at the front end of the drier where these gases are reversed and passed through inside of the drier shell carrying off the liberated moisture. At the discharge end of the drier, in the spout leading down to an

The entire equipment is electrically driven throughout, the current being furnished from a power house located in Marceline, and each unit is driven by an individual motor, alternating current being used. With the exception of the mill the entire equipment is driven by means of back geared motors eliminating all but one small countershaft and making the installation a safe one from an operating standpoint. A preliminary crusher is usually installed in connection with a plant of this kind, but no crusher was included in this case, as the coal received is screened to pass through a one-inch ring. In a permanent installation the crusher is necessary as the coal received will be of various sizes and grades. One miller and one laborer only are required for operating this plant during one shift. The power required by the entire plant is about 17 hp. hrs., per ton of coal handled.

HEARING ON SAFETY APPLIANCES

The Interstate Commerce Commission held a hearing at Washington on March 1 on the application of the railroads for a further extension of time of one year from July 1, 1917, within which to complete the equipment of their cars with safety appliances in accordance with the order of the commission of March, 1911, and the law of 1910. The commission had allowed the railroads five years within which to equip their cars and later granted another extension of one year until July 1, 1916.

A. W. Thompson, vice-president of the Baltimore & Ohio, appeared on behalf of the executive committee of the American Railway Association and told the commission that on January 1, 1917, out of 2,519,832 cars 296,033, or 11.7 per cent, were not completely equipped to comply with the law. Mr. Thompson said that the abnormal amount of traffic handled by the railways during the past year has greatly increased the difficulty of equipping the cars, because the mechanical forces have been busy in keeping up the necessary running repairs. Other railroad men testified also.

The various witnesses were cross-examined at length by W. G. Lee, president of the Brotherhood of Railroad Trainmen, W. S. Stone, grand chief of the Brotherhood of Locomotive Engineers, and L. E. Sheppard, acting president of the Order of Railway Conductors, who strongly opposed the idea of any extension in time and insisted that many of the cars could be equipped without difficulty and without taking them into the shops.

H. W. Belpap, chief of the Division of Safety, testified at the request of the commission. He said he had repeatedly called attention in his annual reports to the need of special diligence on the part of the railroads in getting their cars equipped, but that they had been slow about getting started with the work. He said that during the first six months only 37,000 cars were equipped. In each succeeding six months the number had increased until recently; if the railroads had done as well during the first years as during the last three years, he said, the work would now be completed. He thought that if the railroads had to do it they would succeed in getting a large percentage of their cars equipped, but that it would be necessary first to issue orders that no cars would be received from owning lines until properly equipped and later to issue another order that no car would be received in interchange until properly equipped and that some plan should be worked out by which the work could be done by foreign lines without returning the car home for repairs. He saw no reason why it was necessary for the roads to have this work done at their own shops, saying it could be done just as well in other shops and billed against the owning road, but that some roads had refused to equip cars with safety appliances for other roads. He thought that some roads had not been diligent in equipping their cars and that many could bring a large percentage of their cars into compliance with the order within 30 days.

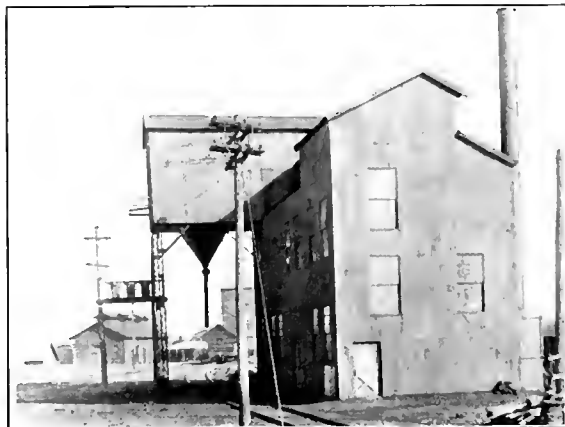

Santa Fe Pulverized Coal Plant at Marceline, Mo.

elevator, is located a Cutler Hammer lifting magnet for the purpose of removing any tramp iron which may be in the coal. After being dried, the coal is elevated and discharged into a bin directly above a 33-in. Fuller-Lehigh pulverizing mill of 14 tons capacity. This machine reduces the coal in one operation so that 85 per cent of it will pass through a 200 mesh sieve. Fine pulverization is very essential for the successful burning of any coal and means rapid and perfect combustion. From this pulverizer the coal is raised by an

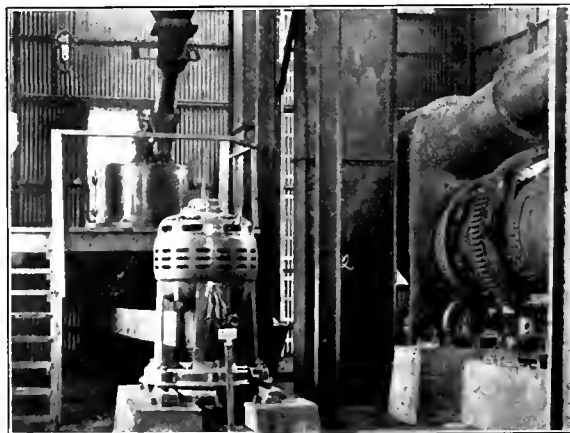

Interior View of the Santa Fe Pulverized Coal Plant

elevator and discharged into a screw conveyor which carries it to a 20-ton pulverized coal storage bin located over the center of the track and arranged for feeding the pulverized coal to the locomotive tender.

The building in which this equipment is installed is of steel frame construction covered with corrugated iron siding and roofing. The installation is an experimental one and some minor details are arranged for only temporary use, as it is intended later to move this plant to some other location.

Car Department

TRAIN LINE MAINTENANCE*

BY A. McCOWAN

Supervisor Car Work, Canadian Northern, Winnipeg, Man.

The report of the Division of Safety of the Interstate Commerce Commission for the fiscal year ending June 30, 1916, stated that there were 908,566 freight cars inspected, of which 3.72 per cent were found defective; and 27,220 passenger cars, of which 1.82 per cent were found defective. The defects which were found by the inspectors were given in detail in tabular form, and those directly chargeable to the air brake numbered 18,096, which was far above those chargeable to any other part of the car, the next smaller item being couplers and parts.

The number of defects per thousand cars inspected was 45.06. Of this number, 20.58 defects were chargeable to visible parts of air brakes; the next smaller percentage being for couplers and parts, which is 6.09. The remaining 18.39 defects are chargeable to hand brakes, ladders, steps, hand holds, height of couplers, uncoupling mechanism and running boards.

While the proportion of air brake defects as shown in the report, which may be classed as train line defects, is comparatively small, it does not show the relative importance of train line defects, because of necessity we have to watch this matter closely and replace most defective hose or broken train pipes immediately. As a result they are seldom discovered by Interstate Commerce Commission inspectors. In attacking this problem, therefore, we should not only attempt to cut down the percentage of cars which the Interstate Commerce Commission safety appliance inspectors find with defective air brakes, but decrease the material and labor in all repairs and renewals.

I have gone into the life of the air hose with the idea that there is a chance of decreasing very materially the number of hose necessary for renewals, and thereby the cost of renewals. The average life of the hose is considered about eight months for air hose and one season for steam hose. In Western Canada we find that the average life of a steam hose is a little over four months. While this may be looked upon as a season in certain parts of the United States, it cannot be so considered in the north.

The Railway Age Gazette stated in an editorial in 1912 that the average life of hose a couple of years previously was only eight months, and that at that time, the life of hose was probably less because the quality of hose was lower, and that the railways buy poor hose because mechanical injury destroys it in a few months, whether it is good or bad. It is the opinion of those familiar with the hose question that a hose should last three years if not subjected to mechanical injury. Since it seems that the average life is only eight months there is a chance for increasing the life of hose two years and four months; in other words, making it last $4\frac{1}{2}$ times as long. The interesting question now is to see what this means in dollars and cents.

In the United States there were in 1915 in service 2,370,532 freight cars, 55,810 passenger cars, 98,752 company service cars—a total of 2,525,094 cars; and 66,229 locomotives.

*Abstract of a paper read before the Car Foreman's Association of Chicago.

This means that there were in use 4,741,064 hose on freight cars, 111,620 on passenger cars, 197,504 on company service cars and 66,229 on locomotives, or a total of 5,116,417 hose. This does not include hose on the front ends of locomotives or between engines and tenders.

The renewals of these 5,116,417 hose, with a life of eight months, would be at the rate of 7,674,626 per year; while if the life were three years, they would be at the rate of only 1,705,472 per year. This is the saving at which we should aim in the use of materials only. There are many other things which, in the aggregate, probably represent even a larger amount of money: viz., the labor of applying and taking off, the cost chargeable to train delays caused by hose or train pipes bursting in transit, capital account tied up in material, etc.

Hose costs from 30 cents to 60 cents or more per foot. Increasing the life of the hose from eight months to 36 months will make a saving in renewals of 5,969,154 air hose per year, which at 55 cents each (the cost of 22-in. hose) is equal to \$3,293,000.

It is claimed that loose or broken train pipes are even more prevalent than defects in hose, and this is borne out by the statistics of the Interstate Commerce Commission. The train line often breaks just back of the angle cock when cars are pulled apart without uncoupling the hose.

What causes all these defects in the train pipe and decreases so greatly the life of the hose?

An inspection of the scrap hose pile will show very plainly that most of the defects in hose are at the nipple end. This is where the great majority of hose fail. The train pipe usually breaks just back of the angle cock. These facts point plainly to the jerking apart of the cars while the hose are coupled, as the main cause. I do not mean to say, however, that pulling the cars apart is entirely responsible for defects at the nipple end of the hose. When a hose is not coupled up and a car is switched around the yard, the hose is swinging constantly and all the strain comes on the nipple end.

The strain on the hose when cars are pulled apart without uncoupling the hose, with train line fully charged, is said to be 500 lb. This not only causes rupture of the hose at the nipple end, but it weakens the fabric throughout the entire length. This stretching is responsible for more hose failures than bending at the angle cock. In a test of 22,000 pieces of air hose referred to in the Railway Age Gazette for February 14, 1913, page 275, 82 per cent were found to be porous, and the porosity was not localized but extended all along the hose. The porosity of the hose is often charged up to poor material when, as a matter of fact, it is really caused by jerking apart.

We are accustomed to assume that tonnage reduction in the winter is necessary because of slippery rails, greater radiation of heat, poor lubrication, etc. Investigations on one road have shown that a great deal of this tonnage reduction is necessitated because of leaks in the train line, the impossibility of providing enough air to operate the brakes on long trains. This subject of leakage is a very important one, not only because of its effect on the tonnage that may be hauled and the amount of fuel consumed, but also because

of its effect on the operation of the air pump and delays which are caused by brakes sticking.

Train line leaks may be classified under the following heads:

- Leaks at the hose coupling.
- Leaks in the hose itself.
- Leaks where the hose connects with the coupling.
- Leaks where the hose is attached to the train pipe.

Leaks in the coupling proper are usually chargeable to the wear and tear of the materials and gaskets, or to the coupling being poorly made by the brakemen or carmen. Leakage is also caused here by snow, frost and ice. Further, when an air hose freezes it often becomes so stiff that it will not bend. This causes the joint between the two hose to leak whenever there is any movement between the couplings, and also causes leaks where the hose is attached to the train pipe, the hose often being pulled loose at this point.

The difficulties encountered and time consumed in coupling and uncoupling hose in winter weather are considerable. Even at zero weather the hose becomes so hard as to lose all flexibility, and during coupling and uncoupling it is necessary to bend the hose, which usually cracks the rubber, making it porous. A hammer is commonly used for hitting the hose couplings to make them lock. This tends to jar the hose fitting out of place in the frozen bag at the nipple and coupling sleeve, causing a leak when the train is in motion, especially when rounding curves. The hammering on hose couplings also damages them to such an extent that it is necessary to remove the hose because the gaskets do not fit properly. This same trouble is experienced on the road because the couplings are drawn up by the frozen hose on curves, causing the brakes to creep on and making it necessary for the trainmen to hammer the couplings down in place. Another difficulty is that all angle cocks are not in proper position to allow the hose couplings to meet in line. The hose is twisted before the couplings can be made to lock and in case they are pulled apart very often they do not unlock, breaking the hose or the train pipe.

The time ordinarily consumed in coupling and uncoupling hose on a forty-car freight train under ordinary conditions at the different winter temperatures is as follows:

Temperature	One man uncoupling	One man coupling
Zero	45 min.	50 min.
5 to 10 deg. below	50 min.	55 min.
15 to 20 deg. below	55 min.	60 min.
25 to 30 deg. below	65 min.	70 min.
35 to 40 deg. below	70 min.	75 min.

The time in the last column allows only for coupling the hose. Any extra time required for changing hose, gaskets, etc., depends entirely on conditions. This ordinarily takes 15 to 20 min., sometimes it takes an hour.

The amount of both yard and road detention chargeable to train-line trouble, not to say anything of car and freight delays, is worthy of consideration. One and one-half hours over each engine division is considered a good average of road detention to each freight train handled under northern winter conditions, caused mainly through hose trouble, creeping on of brakes and extra time taken for pumping up in releasing. Along with this come flat and shelled wheels from creeping brakes; there is also excessive strain on the draft rigging. A broken train line means the cutting out of the car, and not infrequently twenty-four hours' delay to it in getting repairs made.

The defects which develop because of the present hose connections between cars, as well as safety considerations and convenience, early led inventors to the consideration of an automatic connector. Quite a few connectors have been developed to the point of trial, but until very recently none has had an extensive installation.

We are using an automatic connector on the Canadian Northern in both freight and passenger service and have 207 cars equipped. The first installation was made June 6, 1914, so that we have had 32 months' experience with the con-

nectors. The connector which we are using is the Robinson and it has also been installed on a large number of Canadian Pacific passenger cars.

You will realize that in the northern country where the climate is sometimes very severe, we have greater need for a connector than railroads operating in the south. It requires a good deal more steam to heat our cars, and the results of leakage are magnified. Our trains are harder to move after they have stood for a short time because the lubricating oils harden, and for this reason we have to cut down unnecessary stops or delays to a minimum. The makers of this connector are so confident of the life of hose which the connector makes possible that they guarantee a life of three years for air hose used with it.

On the question of leakage I have only to quote from one of the reports which has been given on the connector:

"During the intensely cold weather of December and January, when temperatures sometimes in excess of 40 deg. below zero were recorded in certain parts of Canada where these cars were in operation, no trouble was experienced from leakage in connection with the device, although at the same time it was found impossible to prevent very serious leakage in ordinary hose * * *

"To one familiar with yard and train service, there appears to be no room for argument about the need of such a device. The greater life of hose, the absence of broken train pipes resulting from uncoupling cars without first disconnecting the hose, the saving of time and labor in making up trains, and the reduction in the cost of pumping air, all of which might be classed as direct or apparent economies, would undoubtedly justify the cost of application alone, but the writer is even more impressed with the benefits that would be secured indirectly. Numerous leaks are found in hose and gaskets at all seasons of the year, almost entirely the result of the practice referred to above: viz., pulling the hose apart, thereby injuring the fabric and inner tube. In very cold weather, however, when the hose freezes, the difficulty in preventing air leakage becomes a controlling factor in the operation of long freight trains and they have to be reduced in length to a point where the air pressure can be maintained irrespective of the tonnage ratings or the ability of locomotives to haul them. Even at the best, this factor is responsible for a very great amount of terminal detention and labor on the part of car men trying to stop leaks."

The connector increases the life of hose because it eliminates all mechanical wear. The hose is never jerked or strained. Frozen hose does not interfere with its operation and leakage and breaks are cut down.

We have found on the Canadian Northern that the Robinson connector saves us a lot of money. We estimate the comparative cost about as follows:

Cost of present equipment	\$23.90
Cost of Robinson equipment	36.95
Difference	\$13.05
Cost of maintenance of present equipment for three years	\$45.05
For Robinson equipment	37.49
The saving in three years is	\$ 7.56

For six years the cost of maintenance of present equipment is \$90.10, while for the Robinson connector it is \$47.80, including the interest on the difference in cost between the two systems. This means a saving in six years of \$42.30 made possible with the connector.

I have made no mention of signal hose and but little mention of steam hose. If these were both taken into consideration the estimated saving of \$3,293,000 resulting from the increased life of hose, would be very materially increased. The economy in hose and train pipe breakage, however, sinks into significance when compared with the immense amount which would be saved in eliminating train delays and reducing trainmen's wages and coal consumption by the use of the automatic connector.

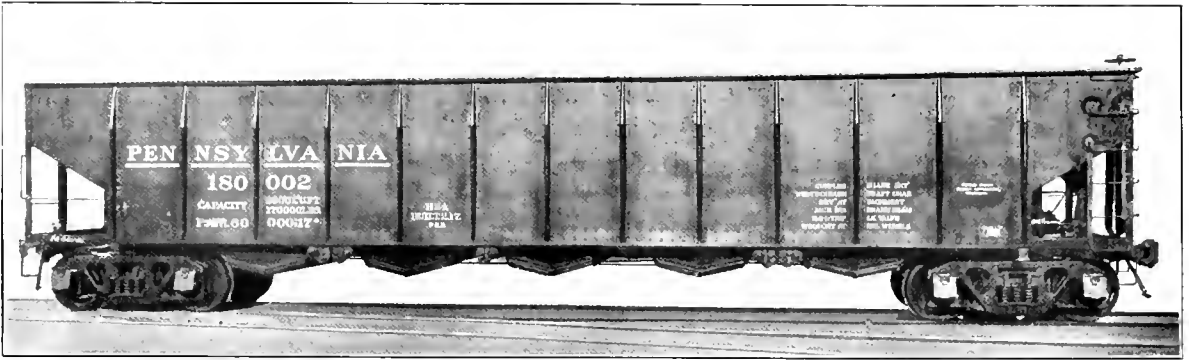

PENNSYLVANIA 85-TON HOPPER CARS

An All-Steel Coal Car Having a Light Weight of 60,000 Lb. and 3,228 Cu. Ft. Gross Cubical Capacity

THE Pennsylvania Railroad has gone one step further in the construction of its all-steel hopper cars and is building, at its Altoona shops, a car which has a capacity of 170,000 lb. and a light weight of 60,000 lb. The new design is known as the Class H-24 car and is patterned after the Pennsylvania Class H-21a hopper car,

load. The general dimensions of the car are as follows:

Light weight	60,000 lb.
Length over end sills	48 ft. 4 in.
Length inside	46 ft. 6 in.
Distance, from center to center of truck	38 ft. 4 in.
Width, extreme	10 ft. 2 in.
Width, inside	9 ft. 4 7/8 in.
Extreme height from rail	10 ft. 6 in.

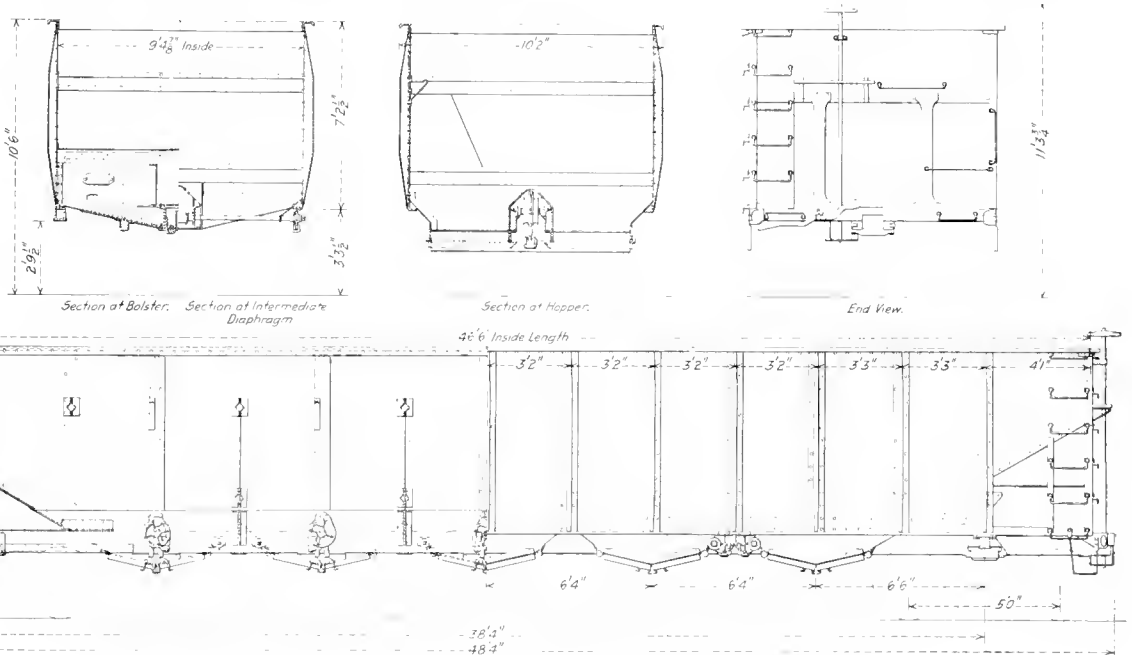

Elevation and Sections of 85-Ton Hopper Car for the Pennsylvania

the details of which are interchangeable. In the new car the cubical capacity has been increased to 3,228 cu. ft. This large amount has been obtained by the addition of a bay 6 ft. 4 in. long thus requiring five hoppers instead of four, which is the number now being used in the Class H-21a equipment.

The top and bottom members of the sides of the new equipment have been increased 50 per cent in sectional area over that of the old equipment, to take care of the

Truck wheel base	3 ft. 10 in.
Truck weight	15,050 lb.
Capacity	170,000 lb.
Cubical capacity:	
Level with the top	2,960 cu. ft.
Contents heaped	3,228 cu. ft.
Total	3,228 cu. ft.

Underframe.—The underframe is characteristic of former Pennsylvania designs, having a well-balanced central member to absorb the buffing stresses, while the major portion

of the load is carried by the side construction. The center sills are two 10-in., 30-lb. channels, 48 ft. 3/4 in. long, strengthened latterly by spacers at the diaphragms, as well as by cover plates at either end. Cast steel striking plates join the end and center sills. The center sills are further reinforced by two other steel castings, which extend forward and backward a sufficient distance from the center line of the bolster to form a draft gear stop and act as a spacer for the center sills at the point where the body bolster is joined thereto. The center sill cover plate and bottom reinforcing angles are not continuous on account of the clearance required by the drop door operating device. A U-shape ridge sheet, the four sections of which form a continuous member extending between the end slope sheets, is substituted for a continuous cover plate, and is so attached to the center sill that there is at least 24 sq. in. of metal to resist bulging. The bottom member of the side construction is a 4-in. by 5/8-in. angle. The end sills are pressed Z-shape members.

The body bolster is composed of a 1/4-in. vertical web plate, cut out over the center sills to permit them to pass through. It is secured at the top to the end slope sheets by two 5-in. by 3 1/2-in. by 3/8-in. angles, 8 ft. 10 in. and 6 ft. 8 1/2 in. long. It is strengthened at the bottom by two 5-in. by 3 1/2-in. by 3/8-in. reinforcing angles, which extend from the center to the side sills. A tie plate passes under the center sills and is riveted to the web plate reinforcing angles on either side, as well as to the center sills, the center sill reinforcing angles and the center sill casting. The center plate is a drop forging.

Four intermediate diaphragms located between the five hoppers transfer the major portion of the load from the center to the side construction. The diaphragms, like the bolster, are of the single plate type, which gives the maximum amount of space for the hoppers. The 1/4-in. diaphragm sheet is divided into three parts, one on either side of the center sills and the central portion immediately above, all of which are joined together by the cross ridge sheets and lower cross ties. The bottom of the web plate is reinforced by two

distinct members; viz., a 5-in. 19.3-lb. bulb angle, as the top member; a 4-in. by 4-in. by 5/8-in. angle as the bottom member, previously mentioned as part of the underframe; twenty-six vertical U-shape posts spaced 3 ft. 2 in. and 3 ft. 3 in. apart, as the details demand, and 3/16-in. side sheets which connect the other three parts. Alternate posts in conjunction with inside butt strips join adjacent

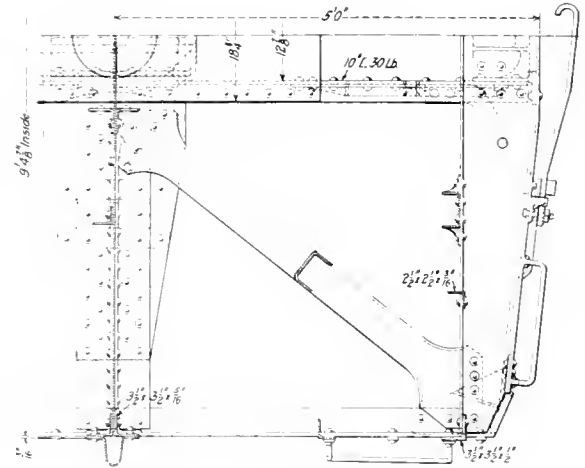

Half Plan of Bolster and End Sill of Pennsylvania Hopper Car

side sheets. The end consists of a 4 1/2-in. by 5-in., 19.3 lb. bulb angle at the top, and a 3/16-in. end sheet connected to the sides by the steel corner casting and an angle corner post. The end sheet extends downward 2 ft. 9 3/4 in. from the top of the bulb angle and is flanged inward at the bottom to support the floor slope sheet. The end floor sheets, ridge sheet and side hopper sheets all slope into the drop

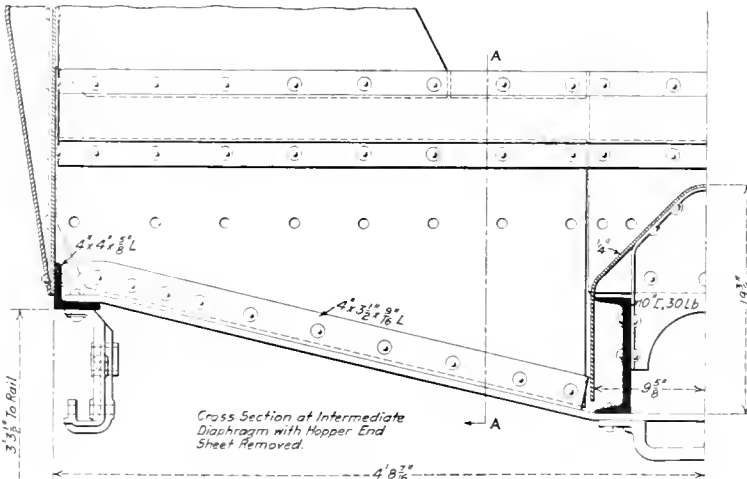

Section Through Intermediate Diaphragm of Hopper Car

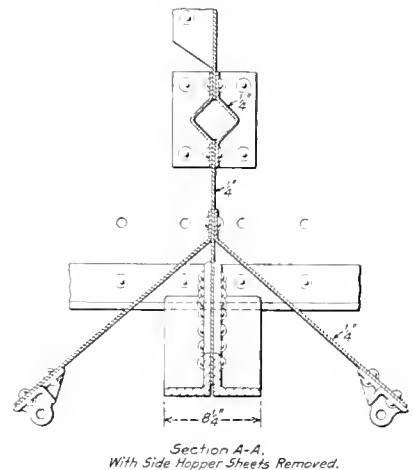

Section A-A, With Side Hopper Sheets Removed.

4-in. by 3 1/2-in. by 9/16-in. angles, the vertical leg of which is cut off at the center sills, allowing the horizontal leg to extend under the sill, thus forming a continuous member from side to side of the car. The top of the intermediate diaphragm web plate terminates between the flanges of a diamond-shaped pressed steel cross brace. Immediately below it are secured the 1/2-in. hopper slope sheets, to the lower edge of which the drop door hinge castings are riveted.

Superstructure.—The side construction is composed of four

bottoms at an angle considered sufficient to discharge the load when the doors are open.

Eight diamond-shaped cross braces, two above each intermediate diaphragm, tie the sides of the car together. These cross braces are located one above the other at a distance of 42 in., the center line of the top one being 27 in. below the top of car. A vertical 1/4-in. gusset plate, 18 7/16 in. wide at the top and 34 in. wide at the bottom, is riveted between the lower flange of the upper and the upper flange of

the lower cross brace, as well as to the side sheets, thus adding materially to the stiffness of the superstructure. The car has five hoppers which are divided by the ridge sheet which spans the center sills into two units each. Each unit has a pair of drop doors which are operated by a mechanism controlled from the side of the car. When in the release position they have a maximum opening of 3 ft. 5½ in. by 2 ft. 11 3/16 in. per pair of doors.

Door Operating Mechanism.—The arrangement of the drop doors and the mechanism for operating them is shown in one of the illustrations. Each door is connected to chain sheaves by two links as shown in section A-A. The door link is attached to the door channel by an adjustable T-bolt which permits the door being adjusted so it will close tightly. The sheave is located directly above the center line of the door opening, between the center sill channels. These sheaves are operated by a chain which passes over the drum shown in section B-B, which is operated by the crank from the side of the car. Ratchet wheels and pawls hold the door in

is composed of a 15/16-in. plate with a 3/8-in. cover plate riveted to the top flanges, supporting the drop forged center plate and side bearings. The bolster is 7 ft. 8 in. long, 17½ in. wide and 14¼ in. deep at the center, tapering to 7¼ in. at either end.

"ONE COAT" PAINT FOR FREIGHT CARS

BY J. H. PITARD

In response to a popular demand for methods of expediting the repairs of freight equipment in the shops, so-called "one coat" paints have appeared in the field and apparently are meeting with favor. Before adopting these paints for general use on freight equipment it is advisable to consider well the degree of protection which they afford and the cost as compared with the usual method.

Some of the "one coat" paints that have come under the writer's observation have proved to be of good quality and make a very credible showing, but there is still some

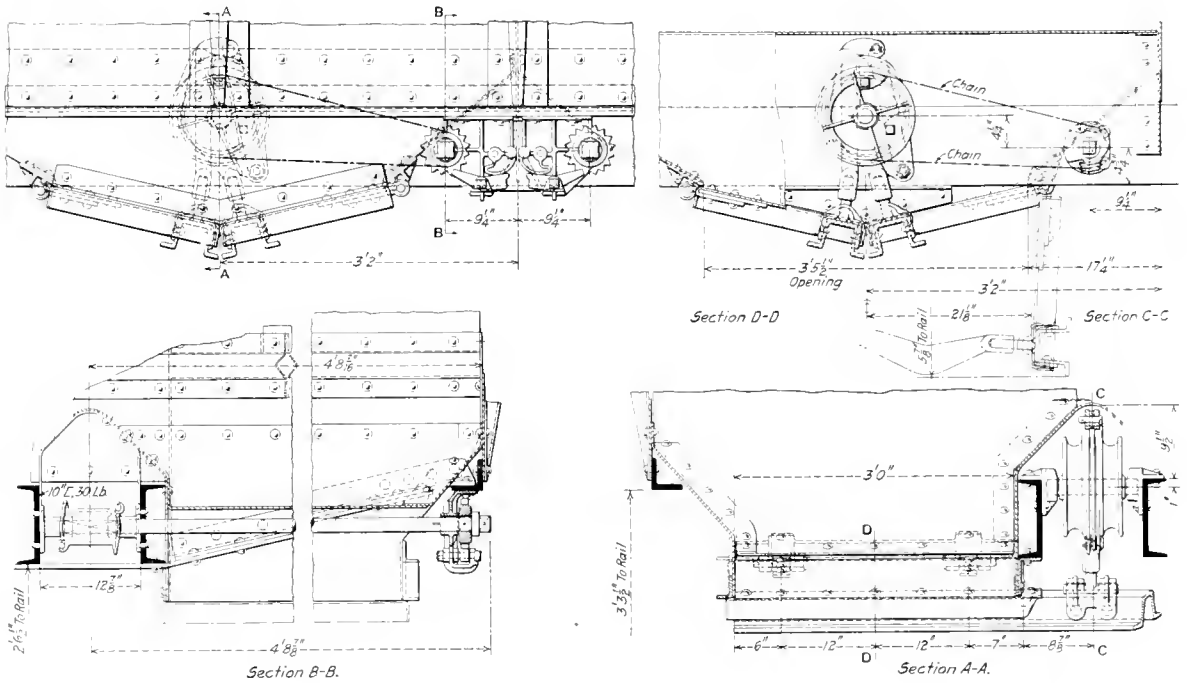

Arrangement of Drop Doors for Pennsylvania Hopper Car

any position desired. In the design of the entire arrangement, effort has been made to have it as simple as possible and easily adjusted.

Trucks.—The car is carried on two cast steel side frame trucks, having a 5-ft. 10-in. wheelbase, 6½-in. by 12-in. journals, and wrought steel wheels. The side frames are of the box section type in which the brake beam hanger supports and bolster guides are cast integral. The cast steel journal boxes, secured at either end of the side frame with 1½-in. box bolts, are also tied at the bottom by 5/8-in. by 6-in. journal box tie bars, upon which rest two ½-in. shims which may be transferred to the top of the box, thus providing for 1-in. adjustment in the height of the center plate.

The spring plank is a pressed section ½ in. thick and 16 in. wide at the center, being spread at the ends to 20 in. The spring plank supports the third point suspension spring which is located at the center and extends in either direction along the center line of the car a sufficient distance to support the end of the brake beam strut. The bathtub type bolster

doubt as to their value as a protective coating. The thickness of the paint film has much to do with the protection afforded either on wood or metal cars, but more especially on metal, for the reason that linseed oil which is the binder vehicle in all freight car paints, is hygroscopic to some extent; that is to say, it will absorb a certain amount of moisture even when mixed with the pigments. Unless the paint film is of sufficient thickness to prevent the penetration of moisture through to the under surface, the paint will not prevent damage to the car. Effective protection from moisture can only be secured by a thick coating, and it is not possible to obtain the proper degree of thickness with one coat of paint.

In the painting of freight equipment, proper discrimination should be shown in the treatment of metal and wooden cars. Regardless of how naked a wooden car has become, if decay has not set in, it can be effectively protected with paint. The surface of a steel car, however, should not be allowed to become exposed, as rusting when once begun is very difficult to check. It may be stopped temporarily with

thick coatings of paint, but the trouble breaks out again as soon as the paint deteriorates sufficiently to absorb moisture to the depth of the surface of the metal. It seems apparent, therefore, that it will be futile to attempt to maintain a steel car to the end of its natural life with an occasional repainting of "one coat" paint.

It is not the object of this article to disparage the use of "one coat" paints, but rather to assign them to their proper sphere. The "one coat" paint serves as an expedient to furnish protection until the car is brought to the shop again for painting and assists in relieving the congested condition of freight car repair tracks. In view of the fact that these paints generally cost much more than the ordinary freight car paints, the general use of such paints does not seem advisable.

MAKING A CAR INSPECTOR

BY A. CAMPBELL
San Francisco, Calif.

Where do the men come from who inspect cars to see that the M. C. B. rules are lived up to? The first duty of the car inspector is to learn to enforce the most important rule of all—"safety first." Many good car men know little of the rules of interchange, but when they O. K. a car or a train you may be sure it is safe to run.

The men who seek positions in the car department reach the railroad yards over many routes and they come there usually for one of two reasons: Visions of adventure may tempt the young, but old or young the compelling reason is in most cases, that they are out of employment and having no regular trade they find here a free and open market for their labor. Out West, at least, most of the men seeking work in this line are what we might call raw recruits. If a man is healthy, and strong enough to make it worth while giving him a trial, the employing officer is usually satisfied. Of course if he has had some experience so much the better, but once in overalls it is largely up to himself how far he will succeed in his new calling.

If the road feels the need, or prefers to make its own inspectors, those in charge will look the new man over to see if he gives promise of future development. He is studied from all sides. What are his habits: is he neat, careful, punctual and energetic; does he write a legible hand and show an inclination to read books or papers helpful to him in his work? These pointers may be picked up in various ways and the foreman will find many opportunities to size up his prospect, often when the man least suspects it.

If the subject looks like a good risk, the way to develop the qualities found is about as follows: Six months on the repair track, three months oiling and about the same time helping the air brake men. Ninety days on air brake work will not make him a finished air brake man, but it will be enough to create an interest in this fascinating branch of the business and will give him an insight into it that will be useful in his after career. Then out in the train yard or on the road, not as inspector but as light repairman or oiler, where the variety of duties will bring him a fund of knowledge that will carry him over the rough places later on. Often he will find himself face to face with problems which, in the solving, will teach him self-reliance and nothing will bring him to favorable notice more quickly than to have it known that he is dependable and can do things well without watching. At this stage he is in close touch with the car inspector's duties. As a kind of understudy, he will learn to know the various classes of cars, their capacity and for what lading they are best suited; there will come a growing familiarity with car wheels and their defects, roofs, doors, siding, couplers and their attachments, trucks, bolsters, side bearings, and so on; he will come to know when a car may safely go forward to its destination, or when it cannot be

safely moved beyond the repair track; he will become familiar with testing air and passing judgment on hot boxes.

All this and much more will be gathered and stored away until the time comes when he will be called upon to say the final word that will hold or send free on its journey the fast freight or loaded passenger train. The successful inspector is the man who, drawing on a multitude of experiences, resolves all doubts in favor of safety. "It may go through to its destination" will not do. A car or a train is either safe to go, or unsafe. All else is chance and the gambler in other people's lives or property is out of place in any position of trust and especially in a railroad yard.

What opportunities for advancement are open to these men? They may be appointed foremen, or with added years of experience may become traveling car inspectors or general foremen. These latter positions, however, call for a more intimate knowledge of the business as a whole than usually comes within reach of the man whose aim at the outset has been limited to the title of car inspector, and beyond this there is little in the records to guide us.

Every car inspector should have a good working knowledge of the M. C. B. rules. The interchange man should be a specialist. They must both be competent to pass on all kinds of loads and also understand the requirements of the safety appliance laws, and everything possible should be done to assist them and make easy the search for the information that will help them in this work.

For the benefit of other branches of the service instruction cars are sent over the road. Would it not be well to have a leading expert with charts or photographs pay an occasional visit to help the car inspector and freight men in this important work? This instruction need not be confined to the placing of lading on open cars but might well cover the disposition of loads in closed cars, and especially should attention be called to the need for protection at door openings, as lack of care in this one particular is fruitful of much trouble and expense. Any car inspector who has worked on outgoing trains or at passing points on the line can readily recall many cases of bulging doors due to the absence of protection. This often means delays in rearranging the load and it frequently starts a good door on the downward path that leads to future damage claims. It will be remembered that this kind of instruction is imparted in a limited but very beneficial way by the Bureau of Explosives, and if the interest aroused by these lectures could be extended to cover a wider field, the claims department work would be lessened to a very large extent.

In this connection it would help to have a supply of large sheets printed and framed, if convenient, showing the various examples in the book, together with the instructions. This constant reminder pasted in car shops, freight sheds and, if possible, in shippers' offices could not fail to arouse interest in this subject and would lead to a very much desired improvement. The books as a rule are scarce and perhaps it would be too expensive to distribute them more widely, but sheets such as I suggest would be a comparatively cheap means of educating the many where the use of the books is restricted to a few.

A final word about the M. C. B. rules. There is room here for an occasional visit from a bright, cheerful instructor or adviser. A well chosen talk from the standpoint of the office man who has to unravel some of the problems arising out of an insufficient knowledge would be well received and be productive of much good.

FLUX FOR OXY-ACETYLENE WELDING OF CAST IRON.—In welding cast iron Ferro-silicon sticks should be used as feeders. A suitable flux consisting of 80 parts boracic acid, 20 parts powdered chlorate of potash and 15 parts iron carbide should be applied to the iron after it has been raised to a good red heat.—*Institution of Mechanical Engineers.*

REINFORCING FREIGHT CAR DRAFT SILLS*

Weak Center Sills Analyzed and Methods of Computing the Strength of the Sills and Draft Arms Explained

BY LEWIS K. SILLCOX
Mechanical Engineer, Illinois Central

FIGS. 1, 2, 3 and 4 concern a single draft sill installation on a 30-ton, 40-ft refrigerator car. The draft sill as shown in Fig. 1 is pulled out and its cross section is shown in Fig. 2. This section has a ratio of stress to end strain of 0.14, the M. C. B. recommendations being that this ratio not exceed 0.06. With a buffing force of 250,000 lb., the fibre stress in this section is 36,000 lb. per sq. in., which is in excess of the elastic limit of the material. By adding a 19-in. by 5/8-in. cover plate to this construction and increasing the thickness of the sill to 5/8 in., the weight will be increased 130 per cent, the strength only 33 per cent, the fibre stress will be 24,097 lb. per sq. in. and the ratio of stress to end strain will be 0.06.

Fig. 3 relates to the same proposition, but in this instance the weight has been increased only 10 per cent, with 43 per cent greater strength and a stress to end strain ratio of 0.08. The last solution to this problem is shown in Fig. 4. It has been handled differently here. With additional material amounting to 127 per cent of that provided in the original design, a relative increase in strength of 67 per cent, and



Fig. 1—Weak Draft Sill Pulled Out

a stress to end strain ratio of 0.05 has been obtained. In other words, the material is working at a factor of safety of five and meets the M. C. B. requirements as to ratio of stress to end strain. The method of computing the fibre stress in this section is shown below.

	A	B	AB	D	AD ²	i	I
Top cover plate—20 in. by 5/8 in.	6.25	11.09	69.31	5.03	158.13	...	158.18
Top chord angles—3 1/2 in. by 3 1/2 in. by 3/8 in.	4.18	9.95	41.59	3.89	63.24	4.9	68.14
Web plate—10 7/8 in. by 5/8 in.	6.74	5.44	36.67	6.2	2.56	68.2	70.76
Web reinforcing plate—10 7/8 in. by 5/8 in.	6.74	5.44	36.67	6.2	2.56	68.2	70.76
Web reinforcing plate—2 5/8 in. by 5/8 in.	1.63	10.71	17.46	4.72	36.32	...	36.32
Bottom chord angles—5 in. by 4 in. by 5/8 in.	10.48	1.12	11.74	4.94	255.71	14.23	269.99
Totals	36.02	...	213.44	19.82	674.10

A = Area.
B = Distance from base of section to center of gravity of each unit.
D = Distance between center of gravity of section and center of gravity of each unit

*Taken from a paper presented before the Car Foremen's Association at Chicago.

I = Moment of inertia of each unit about its center of gravity.
I = Moment of inertia of each unit about the base of the section.
Height of center of gravity of section above the base =

$$\frac{\text{total AB}}{\text{total A}} = \frac{213.44}{36.02} = 6.06 \text{ m.}$$

$$\text{Section modulus (Sb)} = \frac{674.10}{6.06} = 111$$

$$\text{Fibre Stress (F)} \text{ in lower flange due to buffing:}$$

$$F = \frac{P}{A} + \frac{Pe}{Sb} = \frac{250,000}{36.02} + \frac{250,000 \times 2.18}{111} = 11,850 \text{ per sq. in.}$$

Where: P = buffing force.
e = distance between the center of gravity of the section and the center line of draft.

$$\text{M. C. B. Ratio} = \frac{1}{A} + \frac{e}{Sb} = \text{Not to exceed } 0.06$$

$$\frac{1}{36.02} + \frac{2.18}{111} = 0.05$$

Further, if this sill were applied to a box car it would have to take both horizontal (pulling and buffing), and

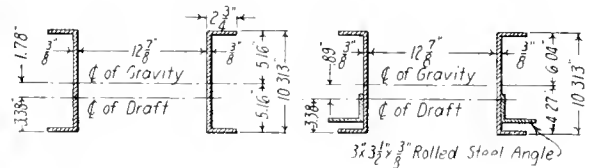

Fig. 2

Fig. 3

vertical (loading in car and dead weight) loading; the former was found to be equal to 11,850 lb. per sq. in., and the latter would amount to approximately 3,800 lb. per sq. in., giving a combined stress of 15,650 lb. per sq. in. As a limit, it might be suggested not to exceed 16,000 lb. per sq. in. under any circumstances. This gives a high working limit in view of the practice on some of the large roads, which use 10,000 or 12,000 lb. per sq. in. as a limit.

A very successful type of center sill construction is shown in Fig. 5. It has been applied to more than 12,000 steel coal cars having an average age of 12 years, and operating in very difficult territory. It has a fibre stress of 6,425 lb. per sq. in. and a stress to end strain ratio of 0.036. It might be mentioned that the sill as shown is only subjected

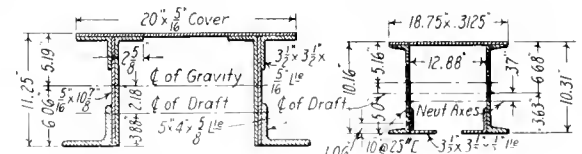

Fig. 4

Fig. 5

to buffing and pulling shocks as the floor plates were located considerably above the draft construction.

DRAFT ARMS

In the matter of draft arms for freight cars, it might be stated that M. C. B. 1915 Proceedings, page 354, requires that the following condition be conformed to:

Section 6—(c). The draft attachments, including draft arms, if used, must be of metal, of either integral or riveted construction.

Section 6—(d). The strength value of the draft attachments and center sill construction must be equivalent to at least 10 sq. in. of steel in tension

and compression, 6¼ sq. in. of rivet bearing area, and 12½ sq. in. in shear. The ratio of unit stress to end strain must not exceed 0.15.

Section 6. (c)—Metal draft arms applied to wooden center sills must extend at least 30 in. beyond the center line of the bolster, toward the center of the car, must be securely fastened to the bolster and center sills, and where possible, should butt against compression members placed between the draft arm and needle beams and also between the needle beams.

Hardwood or yellow pine center sills may be considered equivalent to steel in center sill construction between bolsters if they have four times the specified unit values, namely 40 sq. in. tension and compression area, and a ratio of unit stress to end load not exceeding 0.0375.

Section 6. (d)—The draft gear capacity is indirectly governed by the rule 6—(b).

The intensity of end force is assumed to be equivalent to 250,000 lb. static, which may be concentrated on the center line of the draft gear or

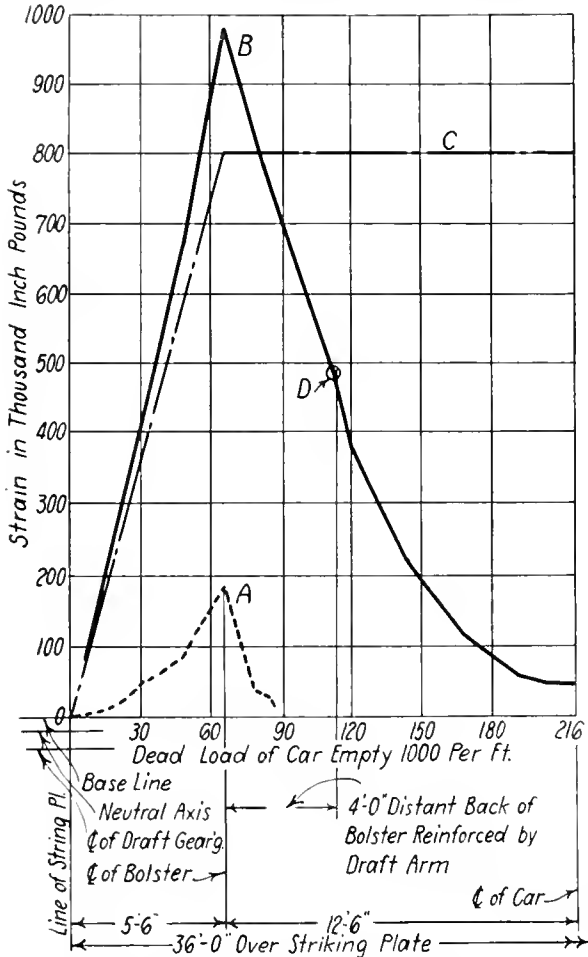

- A = Bending moment curve due to dead load of empty car.
- B = Combined bending moment curve for both impact and dead load of light car.
- C = Bending moment curve due to impact pressure applied 8 in. below the neutral axis.
- D = Safe bending moment for car under frame of six 5 in. by 9 in. sills.

Fig. 6—Draft Sill Stress Sheet (Impact Pressure = 100,000 Lb.)

distributed between the draft gear and the end sill. The point of contact between the horn of the coupler and striking plate is assumed to be 2 in. above the top of the coupler shank. For a shank 5 in. deep the distance from the center line of the draft gear to the assumed point of contact of the coupler horn is 4½ in. The proportion of end force acting on the striking plate is assumed to be 250,000 lb. less R, which is the resistance of the draft gear when the horn touches the striking plate. Hence, when the coupler shank is 5 in. deep and the horn of the coupler is allowed to touch the striking plate before the draft gear is solid, the end force of 250,000 lb. is effective on a line located a distance Y above the center line of draft gear:

$$Y = 4.5 \left(1 - \frac{R}{250,000} \right)$$

All cars are not of steel construction and perhaps the most troublesome problem is to decide what shall be done with

equipment having wooden center sills. Metal reinforcement between the end sill and bolster and for a limited distance behind the bolster has been very successful when applied as an intimate member with the sill and secured thereto in two directions, vertically and horizontally. The curve shown in Fig. 6 covers an analysis of center sill strains worked out for a 36-ft. wooden underframe box car (empty) having six sills of 5 in. by 9 in. section. The strains covered are: Dead weight, assumed to be 1,000 lb. per lineal foot of car; buffing shock, assumed to be 100,000 lb., applied 8 in. below the neutral axis of the sills.

The bending moment in an empty car, due to the dead load is downward between the bolsters, but the combined moment resulting from the dead load and buffing shocks is upward throughout the sills and the truss rods perform no

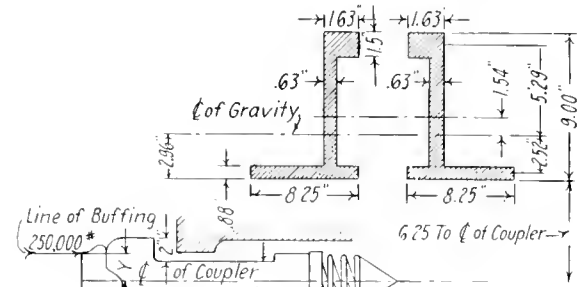

Fig. 7

work. The following is a typical example covering a draft arm problem:

Consider the section over center line of bolster. (See Fig. 7.)

- Coupler = 5 in. by 7 in. shank.
- Draft gear = 2 class G springs or 60,720 lb.
- Buffing force = 250,000 lb.
- Distance between line of buffing and center line of coupler =

$$Y = 2 \text{ in.} + \frac{1}{2} \text{ shank depth} \left(1 - \frac{\text{Resistance of gear}}{250,000} \right)$$

$$Y = 2 \text{ in.} + \frac{1}{2} \left(1 - \frac{60,720}{250,000} \right) = 3.41 \text{ in.}$$

	A	B	AB	D	AD ²	i	I
Web plate—2 x .63 in. by 9.0 in.	11.34	4.5	51.03	1.54	26.88	78.55	103.43
Top chord—2 x 1.0 in. by 1.5 in.	3.0	8.25	24.75	5.29	83.94	.56	84.50
Bot chord—2 by 7.62 in. by 0.88 in.	13.41	.44	5.9	2.52	85.15	85.15
Total	27.75	81.68	273.08

- A = Area.
- B = Distance from base of section to center of gravity of each unit.
- D = Distance between center of gravity of section and center of gravity of each unit.
- I = Moment of inertia of each unit about its center of gravity.
- i = Moment of inertia of each unit about the base of the section.

$$\text{Center of gravity of section above base} = \frac{AB}{A} = \frac{81.68}{27.75} = 2.96 \text{ in.}$$

The distance between line of buffing and center of gravity of the section, or the eccentricity, is equal to 6.25 in. - 3.41 in. = 2.84 in. = 5.8 in.

$$\text{Section modulus} = \frac{273.08}{5.29} = 51.62$$

(The section modulus is taken about the center of gravity of the upper flange.)

$$M, C, B \text{ ratio} = \frac{1}{A} + \frac{\text{eccentricity}}{\text{Section modulus}} = \frac{1}{27.75} + \frac{5.8}{51.62} = 0.149$$

The M, C, B, requirements for this ratio are .15 or less.

The average safe allowable bending moment for six 5-in. by 9-in. (45 x 6 = 270 sq. in.) yellow pine sills is 486,000 in. lb. The maximum bending moment over the bolster (being the combined moment of dead load and 100,000 lb. buffing shock) is 981,500 in. lb., or about double the safe load. By examining Fig. 6 it will be noted that the sill support will have to extend somewhat beyond 3 ft. inside of the bolster as the strain curve crosses the 486,000-in.-lb. limit at a distance of 3 ft. 11 in. Another point to be accounted for is

the fact that in practically all cases sills break over the bolster, the point of maximum intensity, and if the draft sills are extended behind the bolster it is possible to form a substantial connection with bolts and tie plates.

Where wooden and steel sills are to operate in unison, and this should be considered for buffing shocks, it is necessary to provide a cross sectional area of steel equal to one-fourth of that in the wood. For instance, with the center and intermediate sills located very closely together an area of $4 \times 5 \text{ in.} \times 9 \text{ in.} = 180 \text{ sq. in.}$ is obtained and $180 \div 4 = 45 \text{ sq. in.}$ of steel will be required. A continuous draft sill of these proportions would weigh more than 150 lb. per lineal foot or add considerable more than 5,000 lb. to the original weight of the car, it would not be self supporting and the bending moment due to the dead load of the empty car would be increased. A built-up type of crosstie would have to be designed in order to allow the draft sills to be continuous and the bolsters would have to be re-designed if the buffing shock was to be applied normal to the neutral axis of the draft sills.

The reasoning is a little crude in form, but it explains in a large measure, the very satisfactory performance of such application of reinforcement, as compared with a continuous metal member from end to end of the car.

HOT BOXES REDUCED BY FOLLOWING INSTRUCTIONS*

BY J. C. MENDLER

Foreman, Avis Yard, New York Central, Jersey Shore, Pa.

Hot boxes may be eliminated to a great extent if oilers are thoroughly familiar with and follow instructions as to the care and lubrication of journal boxes.

Mechanical defects may be responsible to a certain extent for hot boxes; these defects, however, are not the result of faulty design, but are due to careless preparation prior to application of wheels and bearings, and can readily be eliminated by the exercise of a little care.

The principal cause of hot-boxes is improper placing and care of packing. In all cases a roll or twist of waste which has been dipped in oil and thoroughly drained should be placed in the rear of the box. The balance of the packing should be fed under the bottom of the journal and forced into place so that it rises along the sides to the center line of the journal. In placing packing, all pressure should be exerted under the journal, as this insures a firm medium of lubrication at the bottom and will force the sides into proper position. The packing along the sides of the journal should extend forward to the inside of the collar of the journal. A loose piece of waste having no connection with the remainder of the packing should be placed in front of the box, rising not more than $\frac{1}{2}$ -inch on the collar and slightly tapering toward the front of the box to assist in holding the packing on the sides in place. Care must be taken that the packing is firmly placed; if loosely placed it will settle away from the journal and lubrication will cease when the car is in service.

The packing in each box should be inspected at the terminal yards to determine if it is properly placed. The natural tendency of packing is to move toward the front of the box, hence the oiler should insert the packing iron along the sides of the box to determine if the packing has worked away from the rear. If the rear of the box is not properly protected by packing, the oil when brought to a running heat will be lost. The oiler can remedy this defect by placing the packing iron under the journal and forcing the packing back into place.

Packing which has been in use for some time and which may have been subjected to heat has a tendency to become dry and glazed where it has been in contact with the journal.

When this condition is found the packing should be removed and fresh packing substituted.

Another cause of journals heating is the presence of strands of waste which work under the bearing and become firmly lodged, wiping the journal dry and preventing lubrication. This can be prevented by removing the surplus packing which rises above the center line of the journal. Some roads are apparently packing boxes with the idea that the maximum amount of packing means the maximum amount of lubrication. This is a fallacy and a bad practice, as the packing which rises above the center line of the journal is a source of danger; when the bearing rises slightly under running and switching shocks these high strands have an opportunity of getting under the bearings.

Another cause of hot-boxes is the false idea of economy so generally prevalent relative to the number of men necessary to handle oiling properly. As an example, a recent article in the *Railway Mechanical Engineer* suggests a force of ten car inspectors and four oilers in a yard where from 1,200 to 1,500 cars are handled in 24 hours. A reversal of these figures would undoubtedly give better results in reducing the number of hot boxes.

Last, but not least, a considerable number of hot boxes are due to improper attention on the part of the supervision. Too often, the man in charge is prone to entertain the idea that car oiling is not sufficiently important to occupy much of his time and attention and can be slighted in favor of more pressing duties. Instructions, charts, etc., are furnished the car oiler, but these things are often confusing to the man with the packing iron. A practical demonstration as to the proper method of packing a box, and how and where to look for defects in the packing, and how to remedy these defects when found, given by the man in charge to the man who performs the work, should and will work wonders in the elimination of hot boxes.

CARELESSNESS AND IGNORANCE RESPONSIBLE FOR HOT BOXES*

BY W. H. HICKOK

Traveling Car Inspector, Delaware & Hudson, Watersliet, N. Y.

One of the greatest problems that the railroads have to solve today is that of hot boxes, especially in freight service. To overcome and reduce hot boxes on freight cars to a minimum, we must first have competent instructors as well as competent oilers and box packers—men who will follow instructions and not slight their work.

At the interchange yard every box cover should be raised, and condition of packing carefully examined. This can be done by the inspector stirring up the packing with his packing iron. He should next examine the condition of the brass for end wear, and see if the babbitt has moved or is hanging on the side of the brass, preventing the oil from getting under the bearing; also for any other defect which can be seen by looking into the front end of the box. By doing this, broken brass and wedge, brass having too much end wear, or wedge out of place can be corrected, and in the majority of cases will prevent a hot box. If the car oiler finds the brass and wedge in good condition, packing clean and not cut up, he should work up the packing with his iron, taking care that the packing does not come above the center line of the journals, running all the way back. If packing is found dry, apply a little free oil on the rising side of the journal. When the oiler has finished, box covers should be closed and only those left open that require the boxes to be pulled and re-packed by the box men.

Foremen in charge should see that the proper box covers are applied by the light repairmen when missing. There is not enough attention given to missing covers. When left off

*Entered in the Hot Box Competition which closed October 1, 1916.

*Entered in the Hot Box Competition which closed October 1, 1916.

the packing becomes gritty very quickly, hinders the flow of oil and often works up under the bearing, causing friction. The inspector must see that the lading on open cars is properly distributed, not too much on one bearing. If journals are running extra warm on a loaded car the inspector should ascertain the amount of lading the car is carrying. Station agents can also help by preventing shippers from overloading cars.

A great deal of trouble can be overcome at the repair track by having all boxes carefully inspected for broken brasses and wedges, and all boxes pulled, unless they have been packed recently. Boxes should be cleaned of all grit and the cut up and dirty packing shaken out, re-applying that which is in good condition. Boxes should be packed as follows: A handful of packing, rolled and twisted into the form of a rope should be inserted in the back of the box to act as a dustguard. The box should then be filled by working the packing up to the center line of the journal, the centering hole in the end of the axle serving as a guide for height. Care should be taken to keep the packing inside the journal collar, and not pack the box too tightly. A handful of packing should then be placed in front of the journal as a wedge to keep the packing on the sides in place. This has no connection with the packing on the sides or beneath the journal. No loose ends of packing should be left hanging out of the box to act as syphons in drawing the oil out of the box. The box must not be filled above the center line of the journal, as packing above that point is liable to be caught and drawn in between the journal and the bearing, producing friction. Packing at this point keeps the oil from feeding under the bearing.

It is important when applying wheels to see that the journals are thoroughly cleaned before applying the bearing, and a little oil rubbed over the surface of the babbitt. Special attention should be given to the fitting of the bearing on the journal, for an uneven bearing soon causes friction.

The maintenance of dustguards is also of great importance. When properly fitted, they prevent a great deal of dust and grit from getting into the rear end of the box. It is equally important to keep the trucks square. This prevents the bearing from binding on the journal, resulting in a hot box.

It often happens that hot boxes are caused not from the lack of knowledge of these facts, but from mere carelessness on the part of the men doing the work. If more care were taken and these suggestions followed out, the problem of hot boxes would soon be overcome, or at least reduced to a minimum.

WHY NOT HAVE CAR DEPARTMENT APPRENTICES?*

BY GEORGE A. MARLOW
Foreman, Pennsylvania Railroad, Kane, Pa.

"Who ever heard of serving an apprenticeship in the car department?" was a question asked of me not long since by an engine house foreman. Having been a car department employee during my entire railroad career it naturally set me thinking.

Young men are being trained in locomotive work, machine shop practice, electric lighting, railway signaling and what not. But the car work has been lost sight of, except on occasions when a car man uses "bad judgment" or makes a mistake in the application of that set of complications called the M. C. B. rules. Then the car man comes to the front, is disciplined with a reprimand, suspension or possibly dismissal, for an offense of which he is entirely ignorant. What is done to prevent a recurrence of "bad judgment," or mistakes? Well, we all do about the same thing—give the car man a lecture on what he ought to know, and what he ought

to do, and try to inject a little "pep" into the department in general, after which matters appear to run more smoothly for a time. However, the old roadbed is easier to run on than the new and before long the men are back again to their easy going methods. And why? The answer is: "Who ever heard of serving an apprenticeship in the car department?" If all railroads would begin today to use as much care in employing and educating young men for the car department as they do for their other departments, they would not be bothered with the car man "who didn't know."

There are various opinions as to the exact place where a car apprentice should begin, and through what channels the line of advancement should be. May I suggest the following schedule:

FIRST YEAR (Entirely in Yard)

- Three months as a car tiler.
- Three months as a car repairman on running repairs.
- Three months as a car repairman on yard repair track.
- Three months as an air brake repairman.

Immediately upon being employed the man should be enrolled as a pupil of the educational department; the courses for the first year to be as follows: Arithmetic, simple lessons in car construction, geometrical drawing, first year air brake instructions and United States Safety Appliance standards. Examinations should be prepared once each week under the supervision of the foreman of the car department. The apprentice should also be furnished with the M. C. B. Rules of Interchange, M. C. B. Rules for Loading Materials and the Instructions for Loading Explosives and Inflammable Articles.

Following is the proposed schedule for the second year:

SECOND YEAR

- Three months as a car inspector in the yards (interchange yards if possible).
- One month as a passenger car cleaner.
- Two months as a passenger car repairman (running repairs).
- Three months as a passenger car light repairman.
- Three months as a planing mill hand.

The educational department during this year should furnish courses in: Mechanical drawing, mathematics, electric car lighting, air brake instructions, interpretations of the M. C. B. Code of Rules and further instructions in United States Safety Appliance standards. Examinations should be conducted as in the first year.

The third year should include the following:

THIRD YEAR

- Four months as a car repairman on wooden cars.
- Three months as a car repairman on steel cars.
- One month as an air brake repairman.
- One month as a car painter and stenciler.
- One month as a piece work inspector (after completion).
- Two months as an M. C. B. billing clerk.

The instruction to be furnished by the educational department during this year should include mechanical drawing (including all classes of car construction), air brake instructions, mathematics and general instructions in the various books of rules.

That would possibly enable us to handle the new men, but what are we going to do with the old men? I feel that the old axiom "A man is never too old to learn" is quite fitting in this case. The old men can be educated along simple lines, making them more efficient than at present and enabling them to fulfill their various duties until such time as the railroad might give them an easier berth in which to finish their railroad careers.

STEEL CARS.—In its ability to produce war orders completely within its own plant, the Nova Scotia Steel & Coal Company occupies a unique position. Out of the many thousands of cars built in America, in the past year for the Russian Government, that company, with its order for 2,000 cars, is probably the only builder which mined the ore, fabricated the material and delivered the cars in Asiatic Russia without calling in the aid of any other concern, either for raw material, the manufacturing or the transportation.—*Compressed Air Magazine.*

* Entered in the Address Department of the Chief Interchange Car Inspectors and Car Foremen's Association and presented at the annual convention, Indianapolis, Ind., October 3, 4 and 5, 1916.

PASSENGER CAR FOUNDATION BRAKE RIGGING*

A Discussion of the Defects Found in the Gear for the Single Shoe Brakes When Applied to Heavy Equipment

BY WALTER V. TURNER
Assistant Manager, Westinghouse Air Brake Company

THE foundation brake rigging has an important bearing on the matter of train control. The advantages of improved types of air-controlling devices can be realized only in minor degree unless improvements be made in the foundation brake gear, which today is the weakest link in efficiency in the whole air brake system. The first and essential requisite of foundation brake rigging is that it be designed with due regard to the strength, rigidity, and arrangement which will always maintain the proper volume proportions between the brake cylinder and auxiliary reservoir; that is to say, it must provide a piston travel constant as nearly as possible under all variations in cylinder pressure. Also, it should not apply to the wheels unbalanced lateral pressures so great as to force the journal out from under its bearing, causing journal troubles, and to cause excessive binding between journal boxes and pedestal jaws, thereby permitting a shifting of weight from one pair of wheels to another, due to irregularities in the track surface, and causing wheel sliding. Suitable truck design cannot be dissociated from these requirements for adequate brake rigging.

The single-shoe-per-wheel type of foundation rigging in such prevalent use meets none of these requirements. The lack of

mitted by the just-mentioned spring suspension, pulls the shoe down into the dotted position, and this cumulative effect on each wheel results in the false piston travel RS . The operation of the automatic slack adjuster returns point S and, of course, point R towards point T until distance TS equals the setting of the slack adjuster. This reduces distance RT and, therefore, the brake shoe clearance for release position until in many cases RT actually becomes zero. Point T represents the release position of the piston and point R that piston position where the shoes first come against the wheels. That is, there is very much reduced shoe clearance, or none whatever, with the single-shoe type of brake rigging. And dragging shoes mean highly increased train resistances, with the corresponding reduction in motive power capacity, increase in fuel and water (or electric power) consumption, and shocks due to the necessity for "taking the slack" in order to get a train under way.

The point very difficult for many to grasp, when this action of the automatic slack adjuster is explained (and they immediately suggest dispensing with the adjuster altogether) is that without the adjuster point S might go out so far that the brake piston would strike the non-pressure cylinder head.

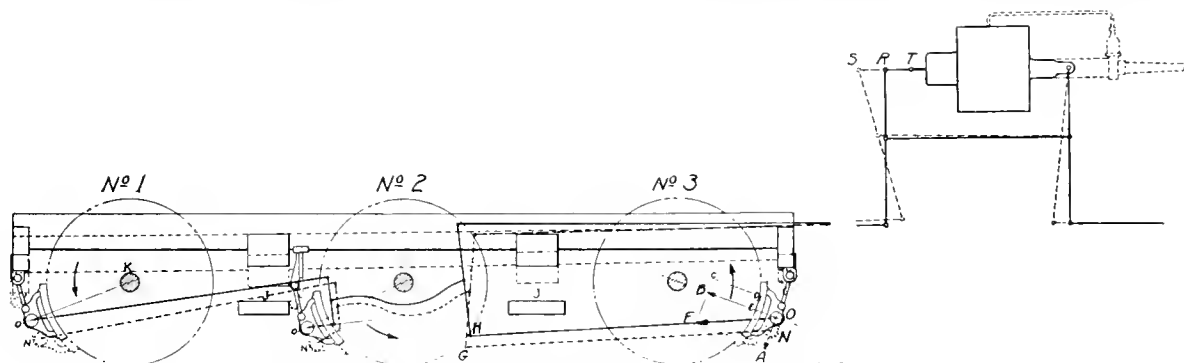

Fig. 1—Relative Positions of Brake Rigging with Light and with Full Service Applications

proper brake cylinder volume proportion maintained by this single-shoe type of rigging is illustrated in Figs. 1 and 2. In Fig. 1 the position of rods, levers, truck frame, and shoes, shown in full lines, are those for the cylinder pressure (about 5 lb.) necessary to just bring the brake shoes against the wheels. The dotted lines show corresponding positions when the cylinder pressure has been built up to some value appreciably higher, such as that for a full service application. The difference in piston travel which this variation in cylinder pressure makes is represented by the distance RS on the center line of the cylinder. This is false piston travel. The pulling down of the truck frame and other parts from the full line to the dotted line positions is caused by the brake shoes being hung at a point on the wheel considerably below the horizontal center line and being hung from the truck frame, which is separated from the journal boxes and the wheels by the usual truck springs. The braking force being applied along the pull rod OH (note the No. 3 pair of wheels for lettering) gives a tangential component OA at the brake shoe, which, per-

And this it would do unless careful and repeated manual adjustments were made—adjustments almost impossible to accomplish in the comparatively minor degree required under present conditions. Moreover, such adjustments would merely duplicate in a laborious way the work of the present slack adjuster, and this remedy would provide no betterment whatever.

The only "fault" the automatic slack adjuster has is that of revealing the evil of false piston travel and the necessity for striking at the fundamental cause in order to effect a cure. Also, in this same connection, it is well to mention that the slack adjuster should take up about one thirty-second of an inch only for each operation instead of the full distance the piston travels beyond the adjuster setting. Otherwise, where the full overtravel is taken up with one adjuster operation, an unusually high cylinder pressure, such as obtained in emergency, would cause the shoes to grip the wheels, with the air exhausted from the cylinder, to such an extent that the car could not be moved at all.

The distance RT represents the piston travel for light brake pipe reductions, and, as before pointed out, short piston travel means correspondingly high cylinder pressures and, therefore, severe shocks in long trains, due to serial brake

* Taken from a paper on Vital Relation of Train Control to the Value of Steam and Electric Railway Properties, presented before The Franklin Institute.

action. What this false piston travel means in the way of giving high cylinder pressures for a light brake pipe reduction at just the time when they are not wanted is shown in Fig. 2. When high pressures are desired heavier brake pipe reductions can readily be made, but if flexibility is to be had it is indispensable that the brake installation permit obtaining light cylinder pressures as well as heavy ones.

Piston travel, where the type of rigging permits it to vary, is a function of the time or duration of brake application, as well as of the cylinder pressure. For a condition of 4 in. false piston travel, as shown in Fig. 2, dotted curve A, in the upper figure, represents more nearly what the variation in travel with cylinder pressure would be for an actual brake application, for the piston travel will not lengthen out immediately. It takes a certain period of time for the jolting of the cars and trucks to assist the brake shoes to pull down on the wheel treads, as illustrated in Fig. 1 and thereby lengthen the piston travel. This is significant, because the shocks occur in the early stages of a brake application. Curve B in the lower figure shows what the condition portrayed by curve A means in the way of high cylinder pressures for light brake pipe reductions. At the point (6 lb. brake pipe reduction) where the brake with the ideal condition of no false piston travel whatever is just starting to become effective, the single-shoe brake rigging with 4 in. false piston

- (c) Delays due to hot journals, stuck brakes and flat wheels.
- 3. Unwarranted expense in:
 - (a) Excessive fuel and water consumption.
 - (b) Reduced capacity of locomotive.
 - (c) Slid flat wheels due to shocks, stuck brakes, and shifting of weight from one pair of wheels to another.
 - (d) Damage arising from shocks, even causing break-in-twos.
 - (e) Hot journals.
 - (f) Burned brake shoes and brake heads.

Obviously, the way to cure these troubles is not to dally with the effects, but to strike back to the underlying causes

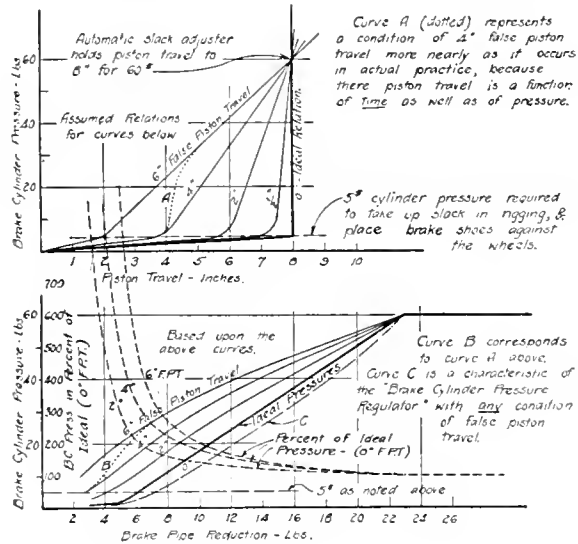

Fig. 2—Effect of False Piston Travel on Cylinder Pressure

travel has about 21 lb. cylinder pressure, as shown by curve B. Is there any wonder that shocks occur in the long passenger trains of to-day? It is necessary to make at least a 6 or 7 lb. brake pipe reduction in order to insure that all triple valves apply and that sufficient differential may be set up to release them when desired. In the attempt to put the brakes on lightly and avoid shocks, insufficient reductions are made, with the inevitable result of stuck brakes.

All these things may be summed up in the following:

In modern heavy passenger train service, the single-shoe type of foundation brake gear with inherent false piston travel is responsible for:

1. Rough handling of trains in:
 - (a) Starting violent "taking of slack" necessary to get train under way.
 - (b) Slowing down.
 - (c) Stopping.
2. Inability to "make the time" because of
 - (a) Hard pulling train—due to dragging brake shoes and stuck brakes.
 - (b) Long-drawn-out stops—"dribbling on" brakes in attempt to avoid shocks.

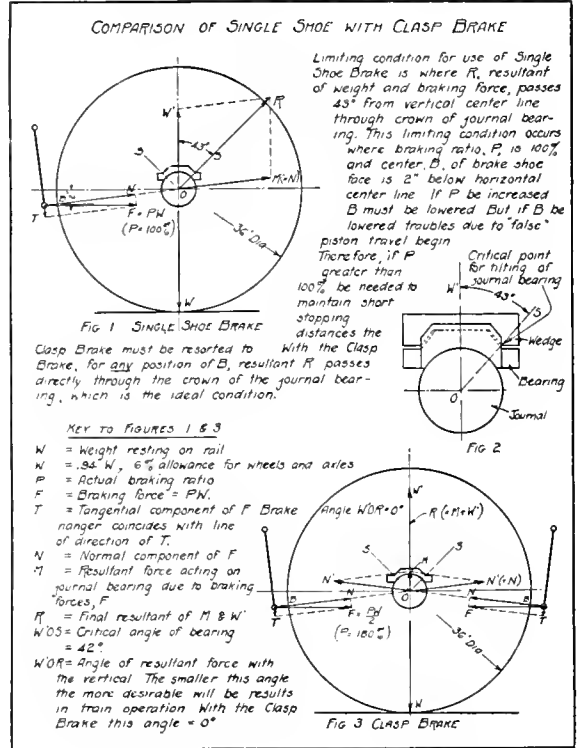

Fig. 3.—Resultant Forces on Wheel with Single Shoe and Clasp Brakes

by applying a suitably designed foundation brake gear of the two-shoe-per-wheel or "clasp" type. The part the single-shoe brake plays in giving journal trouble, and the remedy the clasp brake affords is illustrated by Fig. 3. It proves that the clasp brake should be employed whenever it is necessary to exceed a braking ratio of 100 per cent for either emergency or service applications. And if the point is taken as here established for the failure of the single-shoe brake to be "equal to the job," the need for the clasp brake on account of the overloaded brake shoe will have been cared for long before it arises.

In summing up, it may be said that a well-designed clasp-brake rigging eliminates the single-shoe brake evils above scheduled as no other device can possibly do. A more direct comparison may be drawn up between the single shoe and clasp types of brake gear by saying that with the clasp brake it is possible to have:

1. Shorter stops in emergency, due to reduced brake shoe duty.
2. Reduced brake shoe wear.
3. Reduced brake shoe maintenance
4. No brake shoe dragging reduced train resistances.
5. Longer trains handled with less loss of time, using same motive power equipment.
6. Fewer delays.
7. Smoother stops.
8. More accurate stops.
9. Fewer slid flat wheels.
10. Fewer stuck brakes.
11. Fewer hot journal bearings.



Shop Practice



MASTER PAINTERS TELL OF BENEFITS FROM CONVENTION ATTENDANCE

Three members of the Master Car and Locomotive Painters' Association entered letters in the competition for the best expression as to the benefits derived from convention attendance. They are as follows:

BY C. E. COPP*

Foreman Painter, Billerica Shops, Boston & Maine, North Billerica, Mass.

The Master Car and Locomotive Painters' Association is a mechanical department organization junior only to the Master Car Builders' Association. If experience is anything to qualify a man to speak on the benefits derived from membership in it it seems as if I might be qualified, for the convention at Atlantic City last September was my twenty-fourth without a break. This is enough to get the run of things and average up a fellow as a fair sample, for I have been a constant attendant upon the sessions and president of four conventions.

Specific instances of improvement, however, are wanted. It is difficult to particularize in this matter. I can say that I am an entirely different man from what I was before I began to meet with my fellow workers in annual convention. Then I thought I knew all that was worth knowing, and it was hard to teach me anything more or better than I knew. Now I fully realize that there are scores in this broad land among the various railroads who have been up against just as hard problems as I have, if not harder, and are qualified to teach me many things in my line. Conventions, at least put a man of sense in a receptive mood. If they do not do this he is a hard-shelled egotist and a hopeless case, and had better stay at home, or take a vacation where he can catch fish, for no man can catch ideas at a convention in that frame of mind.

Associations are for the mutual improvement of their members; and the conventions are where they meet for the interchange of ideas. There should be nothing selfish about this. The man who is teachable is apt to teach others. If he meets with his fellows for what he can absorb without imparting anything, he is indeed selfish. On the contrary, if he goes to the meeting bent on hammering his ideas into others and not manifesting a desire to receive and put into practice some of the things he hears, he is an egotist of the first magnitude, to be shunned as such by all who know him.

One who is new at attending conventions might put his finger on the very thing that helped him, but another who has been in the school for many years and has heard all subjects threshed out, not only once but many times, finds it hard to jump up and shout the commendations of any one or two things that benefited him most. A new scholar readily finds a new-found joy, but one old enough to graduate can speak only of the general good the school has imparted to him. It is much the same with association membership and conventions, I fancy. The benefits come surely enough, and are imparted to the company employing him, if it cannot be specified and figured up in dollars and cents. He is broader, more energetic, more efficient, for he feels no longer like one

of "the dumb driven cattle, but a hero in the strife." He gets out of ruts and gets into new ways of seeing and doing things.

I remember years ago galvanized iron entered largely into deck construction of passenger equipment, and I supposed there could be no better coating for this troublesome material than white lead and oil paint, but it got brittle and scaled so quickly that it puzzled me and it remained for John A. Putz of the Wisconsin Central, long since passed away, to straighten me out in this matter at one of our conventions, by saying that there was no better primer for galvanized iron than a good outside car finishing varnish. I tried it and became convinced.

Many other things I could relate if I could recall them. I once got the notion firmly embedded in my head, and wrote a convention paper upon it, that the exteriors of passenger equipment could be finished in enamel exclusively, but it took "Jim" Gohen, formerly of the Big Four, to give me a rude shock and right me up by an address in which he concluded by saying, in substance, "Boys, there's nothing like varnish for finishing passenger equipment exteriors, though you may well treat decks, trucks and steps with enamel." And I was not long in seeing the wisdom of this statement, though reluctant to be convinced at the time. This is important at the present time because a method of finishing cars to the exclusion of clear varnish is being widely championed and advertised.

BY J. W. GIBBONS

General Foreman, Locomotive Painters, Atchison, Topeka & Santa Fe, Topeka, Kan.

Prior to joining the Master Painters' Association my spare time was devoted to a study of the political affairs of our country, or given to the promotion of the fraternal societies of which I was a member, and my vacations were spent in attending the conventions of these societies. I have no desire to detract from the good that these organizations are doing, and, in fact, they should be credited with giving me an experience in dealing with men and in the handling of business in legislative bodies, that has been of great material benefit to me, but the study of the problems which were involved in these conventions diverted my mind away from, or at least took the time from the technical study of, materials and methods used in my own business.

In the Master Painters' Association I met men of wide experience, who not only had the practical but also the technical knowledge of materials which go to make good paint or varnish. The opportunity of meeting and interchanging ideas with these men as to working conditions and materials was, in itself, a great advantage, but affiliation with this association also concentrated my thoughts on the study of the business in which I was engaged.

I was only a member a short time when a subject was assigned to me on which to prepare a paper for presentation at the Ottawa convention. Being a believer of the old saying that anything worth doing is worth doing well, I studied the subject assigned to me from all angles; the result must have been satisfactory for my next assignment was to the chairmanship of the Test Committee. It was with a great deal of hesitancy that I accepted this position, but I set to work and

*Mr. Copp was awarded third prize.

studied paint material, not only from a practical standpoint, but also from the chemical point of view. (Let me state right here that no matter how much experience from a practical standpoint a man may have, a knowledge of the rudiments of the chemistry of paints will be of great benefit to him and the company he serves). This led me to the reading of papers and magazines devoted to the discussion of paint from the technical as well as the practical standpoint. Thus equipped the result of my work as chairman of the Test Committee of the Master Car and Locomotive Painters' Association for the past three years speaks for itself.

As to the benefits to a member in an association of this kind, I would say that it lies within himself to derive much or little. If he attends the meetings and listens to the discussions only, he will secure information that will be of assistance; if he attends the sessions regularly and participates in the debates he not only secures information but acquires practice that gives him confidence in himself and his ideas. I want to emphasize this statement as many men in railroad work have splendid ideas but lack the confidence in themselves to express them.

Last, but not least, are the friendships I have formed which have not only given me great pleasure but have broadened my view of life itself.

The benefit to my employer lies in the fact that the company now has an employee whose mind and reading has been concentrated upon his work and the increased efficiency acquired by these studies and interchange of ideas with men who are in the same line of work. The company also receives the benefit of the increased protection to its property through the knowledge acquired by the tests which are made under the auspices of this association.

BY N. J. WATTS

Foreman Engine Painting Department, Nashville, Chattanooga & St. Louis,
Nashville, Tenn.

Having had the pleasure of attending the Master Car and Locomotive Painters' Convention for a number of years I am able to state from experience that it is to the benefit of the railroad to send the foreman painters to the meetings.

As a rule too little consideration is given to the painting department (and especially the engine painting) by the management.

By attending the Master Painters' Convention and discussing the problems and hearing them discussed by men who have kept abreast of the times I have been greatly benefited and have been able in many ways to use the ideas for the benefit of my employer. I remember at the first of the conventions I attended (Niagara Falls, 1909) I talked with a number of engine painters in regard to the methods and the material they used and found that my company was using more expensive material and getting no better results than was being obtained by others with a much cheaper material. I suggested to my company that we try it; the result was satisfactory and we have used it for several years, thereby saving a considerable amount of money. This is only one of many ways in which the association meetings have been a help and benefit to me, and through me to the railroad. I believe if the railroad officers would take a personal interest in these meetings it would be of incalculable benefit. I remember that at our meeting in Denver, Col., the superintendent of the Denver & Rio Grande met with us and addressed the meeting and how much it was appreciated. (Kind of a "reciprocity feeling," don't you know.)

Then, too, if the officials would make use of the different committees of the association it would be another source of help to both. For instance, the Committee on Information could be of great benefit to superintendents in solving doubtful points. The Test Committee is also of great importance. All who attend the convention are enabled through this committee to see different materials demonstrated, good and bad.

This means the foreman painter can see what is best on the market, learn prices, etc., and by advising with his superintendent or purchasing agent save the company much time, money and trouble.

And last, but by no means least, not only has the foreman and the company he represents been benefited by the knowledge he has gained, but he has had a pleasant outing that has enthused into him new life and new ambition.

PURIFYING SHOP DRINKING WATER

BY W. S. WHITFORD

General Foreman, Chicago & North Western, Milwaukee, Wis.

At the shops of the Chicago & North Western in Milwaukee, Wis., lake water is used for drinking purposes. There are times when this water is not suitable for drinking without purification and the health officers have ordered that it be boiled. The arrangement shown in the illustration was devised to do this and it has been giving entire satisfaction. It consists of a 20-gallon tank set above two 50-gallon barrels, which rest on an ice box. The lake water is fed into the 20-gallon tank and it is boiled by passing steam through a coil located in the tank, as shown. The process of filling the tank is as follows: The 20-gallon tank is first filled with water and the steam turned on to boil it, valves 1 and 2 being closed. The water will be boiled enough in three minutes time to kill all the germs. The 20-gallon tank is then emptied into either of the 50-gallon barrels and the process continued until the barrels are full. When one has been

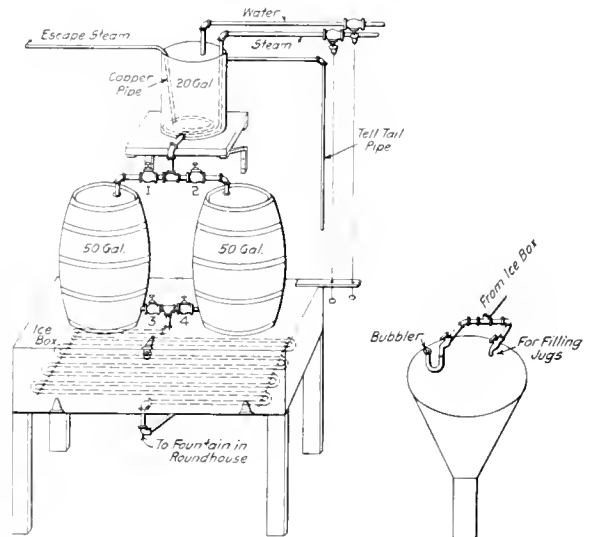

Arrangement for Purifying Drinking Water

emptied—the left one, for instance—the water is boiled with valves 1 and 2 closed. Valve 3 is also closed and the system is fed through valve 4 from the right hand barrel. The left hand barrel is then filled with boiled water through valve 1. The apparatus is set just outside of the roundhouse, completely enclosed and it takes 30 minutes every morning and evening to give the necessary supply of water. Everything is covered so nothing can get into the water and it is always ice cold after it has traveled through the coils of the pipe in the icebox. At the right of the illustration is shown the bubbler drinking fountain and a tap for drawing off the sterilized water for the enginemens' jugs.

ANTHRACITE COAL.—The reports for the year 1915 show that 88,995,061 short tons of Pennsylvania anthracite were mined.

ELECTRICAL EQUIPMENT REPAIR SHOPS

Description of the Facilities for the New Haven at Van Nest, N. Y., for Handling Electrical Rolling Stock

THE New York, New Haven & Hartford now operates over 100 electric locomotives, 27 motor cars and 76 trailers and the repairs to this equipment are made at the Van Nest shops, located on the outskirts of New York City. These are the largest and best equipped plants ever built for the maintenance of heavy traction electrical equipment. In addition to doing general repair work, motors and wheels on freight and switching locomotives are changed, and heavy repairs are made in case of damage due to accidents. Passenger locomotive motors and wheels, however, are usually changed at Stamford, Conn., when such work is necessary between overhaul periods. Both Stamford and Oak Point, New York City, have facilities for inspection and light repairs to electrical equipment, and none of this work is done at Van Nest.

The machine shop facilities at Van Nest are taken advantage of in the manufacture of various small parts used

The armature winding department is located at the east end of the heavy machine tool bay, where it is conveniently reached by the overhead crane and is adjacent to the oven used for baking coils.

The manufacturing balcony extends the entire length of the south side of the shop above the small machine tool bay. Miscellaneous parts required for maintenance are made here, including switch group contactors, blow-out coils, pantographs, third rail shoe mechanisms, brush-holders, etc. Bearings are re-babbitted; and relays, switch groups and other apparatus are also assembled here. Besides the machine shop, this department has a carpenter shop and a small brass foundry. The parts manufactured here are sent to the store-room and charged to the stores department.

HEAT, LIGHT AND POWER

An outstanding feature of these shops is the excellent natural lighting, obtained by skylights throughout the length of the main building and by a row of large windows above and below the crane track, occupying practically all available wall space. The photograph of the erecting shop (Fig. 2) is a good illustration of the results obtained.

Artificial lighting for general illumination is provided by large unit incandescent lamps and reflectors suspended near the ceiling. Extension line receptacles are liberally provided. On the larger machine tools, the wiring for adjustable lamps is placed in flexible metal conduit coming up through the floor, which overcomes the objections to drop lights and extension cords. A forced air heating system maintains a comfortable temperature in the shops during the coldest weather and provides effective ventilation.

All electrical power used in the shops is three-phase, 25-cycle, distributed at 550 volts. The power comes from the three-phase bus at Cos Cob, Conn., about 20 miles from the shops, from which single-phase power is taken for propulsion, and although it is slightly unbalanced, the effect is not noticeable on the motors. All machine tools are direct driven by individual three-phase induction motors and no line shafts or belts are used. This type of installation contributes to the effectiveness of the shop lighting by the absence of belts and line shafts. The equipment is moved into and out of the building by a small steam switching locomotive.

SYSTEM OF OVERHAULING EQUIPMENT

When a locomotive comes in for general overhauling it is at once placed in the erecting shop and taken apart completely. As all parts are interchangeable between locomotives of the same type, it is re-assembled with such parts as are available, and not necessarily with the equipment it contained originally.

Axles and motors are dropped out, the cab lifted from the trucks, and the transformer, switch groups, air compressors, etc., are removed for repair or renewals. The traction motors are dismantled and the fields and armatures are dipped in varnish at 190 deg. F.; then baked for 72 to 100 hours. The practice of dipping the windings at each overhaul period has been found effective in reducing insulation failures. The commutators are also turned and undercut at this time.

A great many effective machines and methods have been developed at Van Nest to meet the unusual problems encountered in handling electric rolling stock. A cab or a motor-car body is handled with two pairs of hooks and two overhead cranes (Fig. 3). Adapters are used on the hooks to fit the various shapes of underframes. A 300-ton vertical

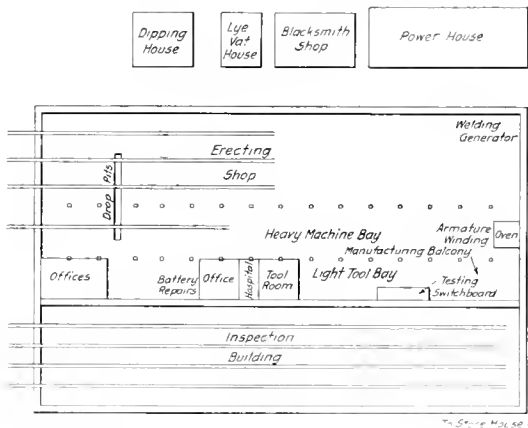

Fig. 1—Arrangement of the Van Nest Shops of the New Haven

in the ordinary maintenance and repair work on electrical equipment.

ARRANGEMENT OF BUILDINGS

As shown in the diagram (Fig. 1) there are two principal buildings, forming together one structure. The inspection building contains four pit tracks; it is used for such work as can be done from the pits, and serves also for storage room. A useful feature of the pits is a shelf walk on each side, on which a man stands when working, while others can pass beneath him along the bottom of the pit without interference; they also make it easy to get into or out of the pit at any point. An overhead platform between the tracks facilitates work on pantographs, enabling a man to cross from one locomotive or car roof to another.

The erecting shop and the adjacent heavy machine bay are each provided with overhead cranes running the full length of the main shop building. These sections are exceptionally well lighted by skylights and large side windows both below and above the crane tracks. The light tool bay occupies the southeast corner of the ground floor, under the balcony, and is lighted by side windows. A space is provided to the left of the office where work is done on the storage batteries used for control and lighting on locomotives, motor cars and trailers. A small motor-generator supplies direct current for charging the batteries.

hydraulic press is used for pushing out armature shafts, quills, commutators, compressing laminations, etc.

TESTING EQUIPMENT

The apparatus for testing air brake equipment, located on the manufacturing balcony, is one of the features of the Van Nest shop equipment. There are three separate outfits, two of which are shown in Fig. 4. The large rack shown in Fig. 4, contains train line pipes, hose couplings and equipment equal to that of a six-car train. This may be divided into three separate parts, each part with its engineer's valve as used on a motor car, freight locomotive or passenger locomotive, connected to distributing valves from the same equipment. A standard yard testing outfit is connected to the rack to represent the train line conditions for a 100-car train. This rack is used for special tests, and with it any conditions of air brake operation encountered on the road may be duplicated in making a test. There is also a standard

A transformer, motor generator and switchboard, on the ground floor, are provided to obtain any voltage, a.c. or d.c., required for testing the control equipment, air compressors and other apparatus.

SHOP EQUIPMENT

Two 60-ton Niles cranes serve the erecting bay and there is one 30-ton crane in the heavy machine aisle. These cranes are all equipped with both main and auxiliary hoists. There are three drop pit tracks in the erecting shop, served by a transfer pit with a narrow gage track and suitable trucks. A hydraulic plunger is located under each track, and equipment is provided so that work may be done in all three pits at the same time. Dropping out axles is accomplished as in steam railroad shops, but special equipment is required to handle the geared motors, which are removed from below after the drivers are dropped out. With this equipment, a passenger locomotive motor and driving axle can be changed



Fig. 2—General View of Erecting Shop for Electrical Equipment

M. C. B. rack shown at the left in Fig. 4 for testing distributing valves.

Another large rack is used for testing pneumatic signal valves, and contains apparatus corresponding to a 10-car passenger train. For testing and adjusting feed valves and reducing valves, special equipment is provided to determine the accuracy of adjustment and sensitiveness of these valves. Compressor governors are adjusted when mounted at the most unfavorable angle for operation, making doubly sure that they will operate when placed upright in the locomotives. On the M. C. B. rack there is an adjustable differential valve used for determining the friction of and testing for leakage around the pistons in the distributing valves or triple valves.

The air brake department tests and repairs equipment sent in from any point on the electrified zone, in addition to that taken from locomotives or cars being overhauled in the shop.

in an hour and forty-five minutes; a freight locomotive with geared motors requires a slightly longer time. Fig. 5 shows the method of removing a passenger locomotive axle with its motor.

Large machine tools include a 96-in. Pond wheel lathe, a 96-in. boring mill, a 60-in. engine lathe, 42-in. wheel lathe, two planers, several other large lathes, a milling machine, boring tools, etc., and a Newton cold saw. Besides the 300-ton armature press before described, there is a 600-ton horizontal wheel press. In the blacksmith shop are a large steam hammer, a forging machine and a double punch and shear for heavy sheet metal.

Two small storage battery motor trucks are used for transportation between the shops, storehouse, lye vat house, blacksmith shop and scrap yard. The varnish tank for dipping armatures and fields is located outside the main shops, to avoid risk of fire. There are two tanks, connected by an

underground pipe with provision for drainage from one tank to the other in case of fire.

Most of the welding and cutting in the shops is done by the oxy-acetylene process. The shop and inspection shed are provided with a piping system, having taps at convenient points, for oxygen and acetylene, for which the feed tanks

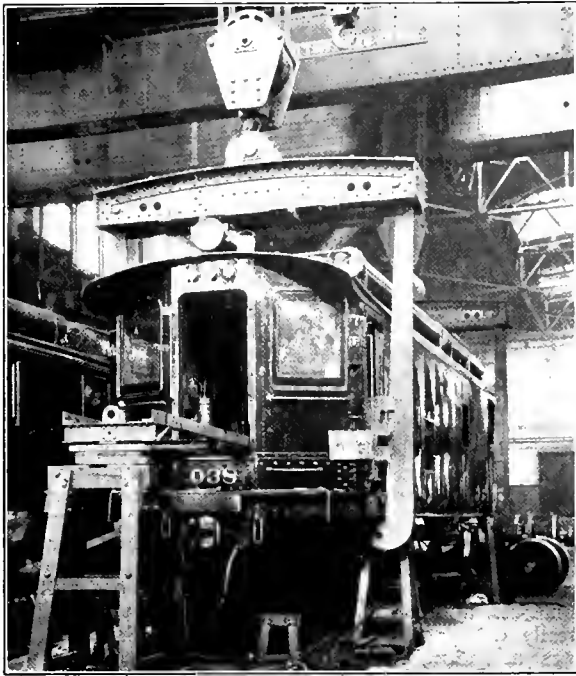

Fig. 3—Crane Hooks for Lifting Locomotive Cab

are located in a separate building. The shop is also wired with special lines for electric welding. Power is supplied from a 400-ampere Ridgway welding generator operating at about 90 volts, driven by an induction motor. Three welding circuits may be operated at once and there is a separate

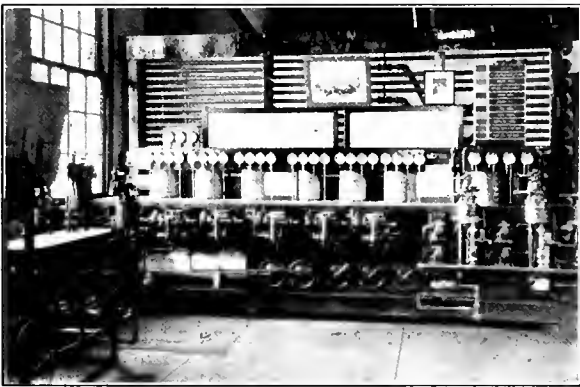

Fig. 4—Air Brake Testing Racks

bank of resistors for each circuit, behind the main switch-board.

SHOP ORGANIZATION

A chief inspector, general foreman, and shop specialist report to the superintendent of shops. The chief inspector and his assistants attend to the inspection of all work done

in the shops, including the complete locomotives or motor cars, any equipment removed for repairs, and all parts made in the manufacturing department.

The shop specialist or tool expert has general charge of design and changes of all shop tools, templates, jigs, dies, etc. Interchangeability and efficiency of tools are promoted by having but one man in charge of this work. It is his duty also to suggest improvements and short cuts in the various shop operations.

The general foreman, besides having general charge of the shop, has particular charge of the work on electrical equipment. A foreman of electrical construction looks after all wiring on locomotives and cars, and pays particular attention to overhaul work, while the assistant electrical foreman superintends running repairs made in the inspection shed. An assistant general foreman reports to the general foreman and has charge of mechanical department work. The electric

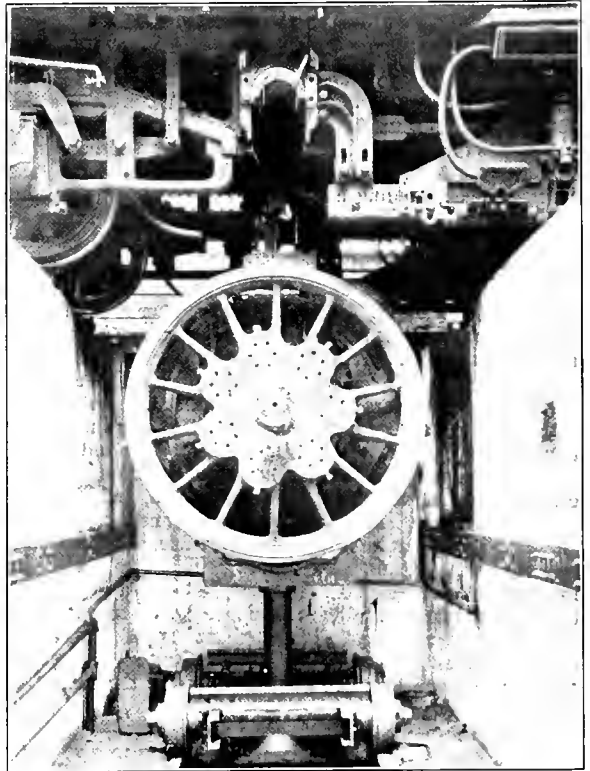

Fig. 5—Dropping an Axle and Motor from a Passenger Locomotive

welding and gas welding work is done under the direction of the pipe fitter leader.

APPRENTICES

Two-year and four-year courses are given to men training in the shops. The special apprentice or two-year course is designed for technical graduates, and includes general training in both mechanical and electrical work. These men may also be called on for work at other points or on the road. The regular four-year apprenticeship course at Van Nest includes two general classes, mechanical and electrical; the mechanical is subdivided into blacksmith, sheet metal and tool maker courses, in which the apprentices put in the full time on specialized work, and the general electrical course, in which is included three months' electrical work, machine shop, assembly, erection, etc., in the different parts of the shop. The electrical apprentice is given experience in all

electrical work done in the shop, including armature winding, and in addition spends three months at mechanical work, principally in the machine shop.

MAKING "STICKERS"

BY HARVEY DEWITT WOLCOMB

Railroad shops have been hit harder than any other class of industrial plants during the past two years, when workmen have been in such great demand for the production of munitions. To make matters worse, the railroads have done a record breaking business, which, in many cases, has compelled them to increase their forces. Under such conditions to lose their best workmen—those mechanics who, because of their skill, are in demand wherever they go—is a very costly experience.

However, with all its handicaps, many good men could be retained in the railroad shop if the foremen would use a little common sense in their methods of dealing with the men.

Bill Mead's experience is by no means an uncommon one. Bill was a typical "boom.r" machinist. For ten years he had worked in many shops, generally riding into a town on the "bumpers" and staying only long enough to make a "stake" before moving on wherever his fancy directed.

Bill was the victim of genuine hard luck, which had forced him into the life of a "boomer." At one time he had been a good citizen, holding a job in a large railroad shop, but misfortune had come to him, first through the loss of his wife, who was killed in a runaway accident. Although this was a severe blow, Bill did not give up his home, but devoted himself to the bringing up of his little daughter. About one year later his daughter died. Having no other near relatives, he gave up, and began to drift here and there in an effort to forget his troubles. At first he became a hard drinker, but as this gave him no relief he gradually gave up this bad habit.

After about 10 years of drifting about he made up his mind to settle down and begin all over again. Coming into a large terminal one day last fall, he decided to get a job in the shops and make a man of himself. He hunted up the office of the general foreman, who hired all the workmen, and stated his desire to secure work. He proved by his answers to all the questions asked that he really knew his trade, and as the shop was very much in need of workmen at that time, all the arrangements were quickly made and Bill had a job. After the regular routine had been completed, Bill turned to the general foreman and asked him to recommend, or at least direct him, to a respectable boarding house. He was a stranger in town, and was anxious to secure the right kind of boarding quarters.

"What the h—l do you take me for?" angrily asked the general foreman. "Do you think I am going to give you a job and then take you home to keep, too? I have all the troubles I can tend to right out here in the shop without running all around town looking up boarding houses for every bum who comes along."

Bill finally found a boarding house himself, and proved that he was a first class machinist. However, he didn't stay long, for his first impression had not been very pleasant and he felt an aversion for the shop.

One day he laid off a half day and took a train to a small town about 20 miles away, where there was a large manufacturing plant. On asking for employment at this place, one of the first questions asked him was whether he had as yet secured boarding quarters. The clerk, who was making out his employment papers, spoke to his superior about a boarding place, and you can imagine Bill's surprise when the superintendent of the plant was summoned to take Bill out in his automobile to look at several boarding places. They were gone less than 30 minutes, but Bill had had a chance to study the superintendent and found him to be every inch a man. The first day of the following week Bill started

to work in that factory. He has since been promoted to a foreman-ship.

Take the case of Tom Jones. Here was a man who had failed in business, and who had been a first class mechanic before he took up a business career. As soon as he lost his business he turned again to his trade as a means of earning a living for his family. As he was too proud to remain in the town where he had failed, he went to a railroad town not far away and applied for work. The shops being short of workmen, he was quickly hired, but when he asked the general foreman about the schools, stores, houses and other similar matters which he wanted to know about for the benefit of his family, he was very much surprised to have the general foreman reply that he was no book of information and would be d—d if he would look up any information like that. With this kind of an answer, Jones picked up his grip and went to the next town, where there was a large manufacturing plant.

Here the superintendent's chief clerk took him out to look at houses, took him out to the high school, where he met and talked with the superintendent of schools—in fact, spent nearly half a day with him. Jones is working in that factory to-day. His value to the plant has been demonstrated several times by labor-saving devices which he has worked out, and for which the management has paid him extra. It now seems probable that the next superintendent of that plant will be a man by the name of Tom Jones—a man who has more than proved his worth to an industrial corporation, but whom the railroad company lost simply through the narrow-mindedness of a man performing a most important function—the hiring of men. If Jones was lost, may not many other good men have been turned away or have drifted away because of the actions of this same foreman?

Go into almost any railroad shop and one will not find the atmosphere of "brotherly love" which should really exist. There is the case of Bill Smith. Smith was a fine workman but had one serious fault. He drank. He was an old timer in the shop and because of his unusual skill had always been taken back after his sprees. Not long ago he applied to the general foreman for an increase of one cent an hour in his wages. He was curtly turned down with the remark that the company was not increasing the wages of "bums." Shortly after this, the superintendent of a large factory in the same town met him and asked him if he would like to try a job in the factory. "What will you pay me?" asked Smith. "Well, I'll tell you just how it is," replied the factory superintendent. "We know that you drink too much; if you take a job with us and continue to drink, you will only be worth 40 cents an hour to us, but if you will cut out the drink you will be worth 70 cents an hour." Smith has "cut out" the drink and apparently his reform is permanent. The railroad has lost a good workman and the factory has gained one.

At another large shop it seemed almost impossible to hold workmen. One incident is sufficient to indicate the reason why this was so. The master mechanic in charge at this point was known as a "horse" for work and insisted that his men must work just as hard as he did. Suddenly during one of the severe cold spells in the winter, his roundhouse foreman laid off, reporting sick. Although this foreman had not missed a day for nearly a year, the master mechanic was very angry when after three days the foreman had not yet returned to work. Just before leaving the shop that night he sent a short note to the foreman's home. The note read: "Get on the job to-morrow, or else get off." The next morning the note was returned by the foreman's wife with these words written across one corner: "Mr. Smith, Master Mechanic: My husband died this morning at 2 o'clock." It is not necessary to comment on the feelings of the foreman's wife. However, if this situation had been handled as it would have been in an industrial plant, the widow would not have added to the difficulty of holding workmen at that point,

by the recital of her husband's treatment in the time of trouble. An industrial plant in the same locality has a regular sick committee which visits every workman on the second day of his absence from work, and when one of the foremen is sick, the superintendent himself makes a personal visit.

Here is another case. A "boomer" mechanic got into some kind of trouble after working hours and was arrested. As soon as this was found out, he was immediately shown out of the service; for it was understood that "crooks" were not wanted. Another factory manager who was anxious to secure workmen heard of the case and interested himself in it. He found out that the workman was in no way to blame for any wrong doing, so he promptly went on his bail and gave him a job. To-day this same "boomer" is a steady workman. Just another case where the railroad overlooked the opportunity to secure a badly needed "sticker."

A master mechanic wanted a certain letter that had been filed for some time. The regular file clerk had resigned to accept a better job elsewhere and none of the office force could locate the desired letter. The master mechanic was heard to remark that when he got another satisfactory file clerk, he wouldn't let the devil himself get that clerk away from him. Shortly after this, he greeted one of his best mechanics, who came into his office, as follows: "Well, what kick have you got now? At the rate you come up here you must wear out a lot of shoes, for you are the most regulator visitor I have."

MODERN RAILWAY SHOP LIGHTING

An excellent example of adequate lighting facilities of railway shops may be found in the main shop building of the Ferguson, Ky., shops of the Cincinnati, New Orleans & Texas Pacific. This building contains the erecting, boiler, machine, blacksmith and pipe shops. The electric power system is 250 volts direct current. The old lighting system, which consisted of 230-volt direct-current arc lamps suspended from the columns and roof trusses, had proved unsatisfactory from the standpoint of maintenance and efficiency and so was discarded in favor of the high wattage incandescent lamp system. The lamps for the new installation are not connected directly across the 250-volt direct-current lines, but a three-wire balance set is installed to permit the use of 125-volt lamps, as the efficiency and reliability of these lamps are considerably better than that of the 250-volt type.

ERECTING AND BOILER SHOPS

By referring to Fig. 1, which shows a floor plan of the main building, it will be seen that the erecting and boiler shops are in one continuous bay, 466 ft. long by 78 ft. wide. The bay is 49 ft. high from the floor to the bottom of the roof trusses, and it is served by two traveling cranes the tracks of which are 31 ft. above the floor. The lighting in this bay consists of eleven 1,000-watt lamps (lights B—Fig.

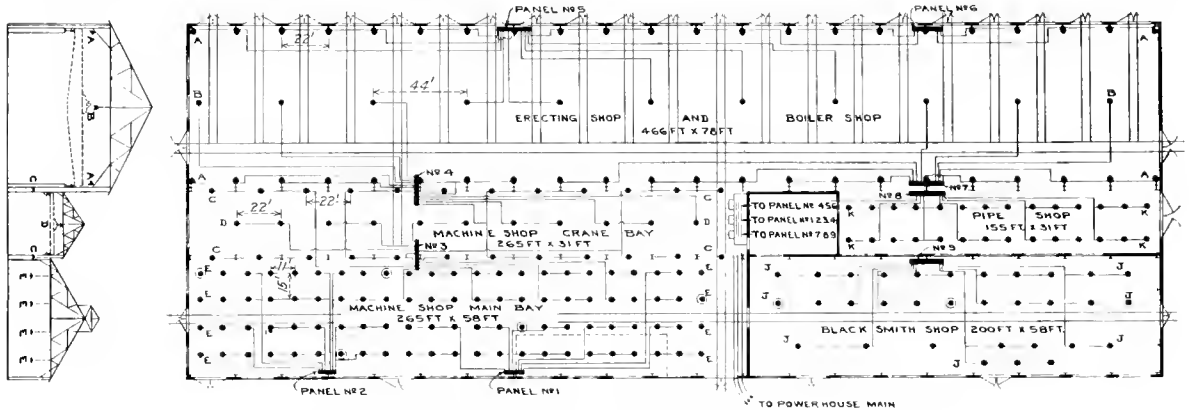

Fig. 1—Floor Plan and Wiring Diagram of the Main Shop of the C., N. O. & T. P. Shops at Ferguson, Ky.

The master mechanic did not know what this man wanted, but as he had asked for a few changes in his working conditions not long before, assumed that he was there again on a similar errand. This time, however, he had come to report an idea for a labor saving device, which he had worked out. After such a reception he took no further action in the matter. Shortly afterward he left the service, and his idea is proving its value in another plant.

The costliness of firing men has been brought out too many times to require any discussion here. But is it not just as costly to let men drift out of the service, or to discourage those entering the service? The slight additional effort required to put the human touch into the relations of the foreman and workmen has been found to pay in industrial establishments and on some railroads. It will pay the others just as well.

A NEW HEAT INSULATING MATERIAL.—Prof. R. C. Carpenter, in the Sibley Journal of Engineering for December, 1916, reports the results of tests of balsa wood, Ochroma Lagopus. This wood is of tropical origin, lighter than cork, strong, elastic and a good heat insulator. After being treated, balsa wood has been used for insulating refrigerating compartments of vessels and should be adapted to use in car construction.

1) in deep fluted bowl reflectors, evenly spaced on the center line, 44 ft. apart and suspended from the roof trusses at a mounted height of 41 ft. above the floor. There are also twenty-two 500-watt lamps (lights A—Fig. 1) in elliptical angle reflectors on each side wall, or a total of 44 in the bay. The elliptical reflectors are spaced 22 ft. apart and are set at a mounted height of 40 ft. This height of installation was necessary to avoid the shadows cast by the overhead cranes. With poor reflector conditions, a current consumption of 0.9 watt per sq. ft. gave an average intensity of 6½ foot-candles on a reference plane 3 ft. from the floor.

The appearance of this shop under night conditions is illustrated by the photograph, Fig. 2. It will be noted that there is a remarkable absence of shadows, which demonstrates the high illumination efficiency of the installation. The proper illumination of such a building presents a most difficult problem because of the deep holes or spaces between the locomotives. The illumination is particularly uniform between the locomotives and around the wheel lathes in the foreground at the right.

MACHINE SHOP CRANE BAY

As shown in Fig. 1, the machine shop crane bay is 265 ft. long by 31 ft. wide; the distance from the floor to the bot-

tom of the roof trusses is 20½ ft. and the aisle is served by one traveling crane which operates on a track 20 ft. from the floor.

The lighting installation consists of eleven 500-watt lamps (lights D—Fig. 1) in deep fluted bowl reflectors suspended from the roof trusses on the center line. The units are 22 ft. apart and are suspended to give a mounting height of 25 ft. from the floor. There are in addition twelve 100-watt lamps (lights C—Fig. 1) in flat cone reflectors on each side of the bay, or a total of twenty-four 100-watt units. These reflectors are suspended under the crane track, are evenly spaced 22 ft. apart and are installed to give a mounting height of 12 ft. With approximately one watt per square foot this installation gives an average illumination of seven foot candles. Fig. 3 shows the machine shop crane bay at night with artificial illumination. There is hardly a shadow to be seen and all parts of the shop stand out in clear relief. The photograph shows the location of the various fixtures very clearly, especially those which are suspended from the crane track.

MACHINE SHOP MAIN BAY

The machine shop main bay, as shown in Fig. 1, is 265 ft. long and 68 ft. wide, and the distance from the floor to the bottom of the roof truss is 20 ft., or 6½ ft. lower than the machine shop crane bay just described.

A special condition was met in this shop which necessi-



Fig. 2—Night View of Erecting and Boiler Shop

tated a slight departure from the standard scheme of mounting large units as high as possible. The machines in this shop are belt driven from overhead line shafts, so that in order to avoid shadows the lamps were suspended below the line of belting, as shown in Fig. 4. The lighting in this bay consists of ninety-two 100-watt bowl frosted lamps (lights E—Fig. 1) in shallow bowl reflectors arranged in four rows of 23 lamps each. The units are evenly spaced in rectangles 15 ft. by 11 ft. and are suspended from the roof trusses so as to give a mounting height of 11 ft. With 0.6 watt per square foot, this arrangement gives an average illumination of over five foot-candles on a reference plane 3 ft. above the floor.

The arrangement of circuits and lamps is shown in the lower left hand corner of the wiring diagram in Fig. 1. Photographs showing night views of this shop are reproduced in Fig. 4. It should be noted that the main line shafting over the center of the aisle drives counter-shafts for machines on both sides, so that horizontal belts from the center go both ways; the photograph shows that the lighting units are low enough to clear these horizontal belts so that they in no way interfere with the illumination. Bowl frosted lamps were used to minimize the glare which would otherwise be noticeable from fixtures at such a low mounting height.

BLACKSMITH SHOP AND PIPE SHOP

The lighting installations in the blacksmith shop and pipe shop in the main building, and the offices and storerooms in the other buildings, follow the same general scheme of overhead illumination which has just been described for the other shops in the main building. The arrangement of circuits and the location of units in both the pipe and blacksmith shops are shown on the wiring diagram in Fig. 1. A daylight



Fig. 3—Machine Shop Crane Bay Under Its Own Illumination—Note the Absence of Shadows

view of the blacksmith shop showing the location and relative height of the lighting fixtures is shown in Fig. 5.

The type of fixture used throughout consists of a porcelain enameled steel reflector with a fitting tapped for direct connection to ½-in. rigid conduit, and each fixture is suspended by a standard suspension fitting and arc lamp hook clamped to the overhead conduit system. Such a suspension enables the entire fixture to swing freely in any direction,



Fig. 4—Night View of the Main Bay of the Machine Shop

which prevents breakage of the stem at the outlet box in case the fixture is struck by a broken belt or handled roughly in cleaning. The entire wiring system is installed in rigid iron conduit and distributing panels are mounted in steel cabinets located at convenient points about the shop.

WATCHMAN CIRCUITS

For the convenience of the watchman, and to avoid burning an unnecessary number of lamps when the watchman goes through the buildings or shops, three center lights in the

erecting and boiler shops are provided. They give sufficient illumination and take a minimum amount of current. In the machine shop and blacksmith shop the eight lamps designated on the diagram in Fig. 1 by double circles are on two special watchman circuits, which are entirely separate from the main circuits.

FIXTURE CLEANING

Nitrogen-filled tungsten lamps are used throughout the main shop building. Figures showing the cost of maintenance of these units are not yet available as only a few of the larger lamps have required renewal since they were installed eleven months ago. It has been found that the larger reflectors located in the erecting shop, where the mounting is very high, require cleaning only every 60 days, but the other

RENEWING BOILER TUBES

BY DANIEL CLEARY

As 98 per cent of the boiler failures are caused by tubes leaking, care must be taken when renewing them. With proper workmanship a large percentage of these failures can be reduced. When the tubes are taken out the back and front tube sheets should be straightened, so that only one or two lengths of tubes will be required. The holes should be rolled lightly in the back tube sheet to break the scale around the tube holes, so that with very little filing a clean tube hole will be obtained.

The tube holes should be countersunk on both sides of the back tube sheet with a rosebit countersink. This will permit prossering the tubes without cutting them. The copper ferrules should be prossered lightly in the tube holes. The roller expander should not be used to fix the ferrules in the sheets as this makes the copper hard and it will not fill in the pitted places that are found on the tubes. A good thickness for copper ferrules is .095 decimal gage copper. Ferrules of heavier gage should be kept in stock to be used when some of the tube holes become large and thus permit using one size of swedging for the complete set of tubes.

The tubes should be swedged down to fit in the back tube sheet with a driving fit—say with four or five blows of a light backing hammer. The tubes should be set with 3/16-in. extending outside of the sheet for beading. A mandrel should be used to set the tubes and they should be rolled with a roller expander, good judgment being used not to roll them too hard. If they are rolled by hand, a lever 12 in. long should be used to pull the expander and the lever should slip through the holes in the expander pin. A lever 18 in. to 24 in. long should not be used as the power thus obtained will ruin the tools as well as the tube sheet holes. When the tubes are all rolled they should be belled out for prossering and beading. Care should be taken that the end of the tube left for beading is turned over enough to allow the prosser expander to reach through far enough so that the tube and the copper ferrule will not be cut partly off. When the tubes are belled out and prossered first there will be from 1/8 in. to 5/16 in. left for the bead and it will require three different sized beading tools for a complete set of tubes. One should be all that is necessary.

Experience and tests have shown that when starting at the bottom of the tube sheet to prosser and roll a set of tubes that by the time all but the two or three rows from the top flange are done, the tube holes in the top of the sheet and at the corners will become out-of-round. Similarly if the tubes are prossered and rolled from one side to the other the holes on the far side are sometimes badly out-of-round. This will cause cracked bridges and will always be troublesome. It is a good practice to roll 12 tubes, front and back, on about 12-in. centers to hold the front and back tube sheets in their proper positions. Where this is done no trouble will be had with the length of the tubes provided they have been cut to the proper length. The tubes should be rolled and prossered in a diamond-shaped enclosure first, then the tubes in the bottom and top corners can then be rolled and prossered. A long stroke pneumatic air hammer should not be used on the two rows of tubes next to the flange as it will start cracks in the knuckle of the flange running out from the tube holes. It will also injure patches. If the two outside rows are prossered with a backing hammer there will not be as many cracked tube hole bridges.

To make a first class tube setter, select a young man with intelligence who is honest with his work. He should have experience in rolling 10 or 15 sets of tubes in front ends and should have good practice using the pneumatic air hammers. He should be instructed by a first class tube setter on the first three or four sets of tubes he handles. He will learn more kinks in the few days he is with a good instructor

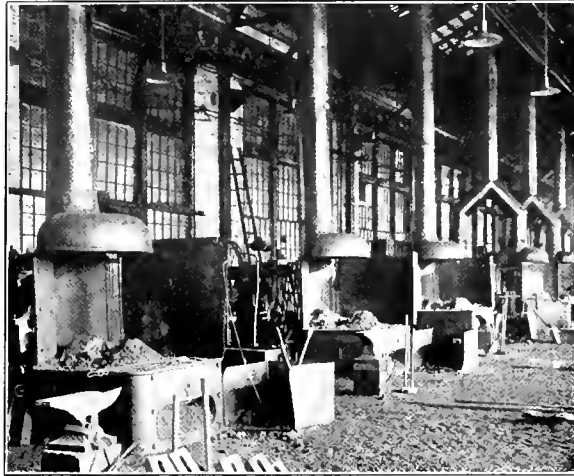

Fig. 5—Blacksmith Shop, Showing the Arrangement of the Lights

reflectors are cleaned every two weeks. In this connection it has been found that where a reflector is subjected to a current of air caused by a belt, the dirt will deposit much more rapidly than in other locations.

In considering the lighting installation in these shops, it is worthy of note that no drop cords whatever are used. Where the general illumination is of sufficient intensity, drop cords and extension lines are not necessary.

HOOCS FOR LIFTING DRIVING BOXES

The simple arrangement of links shown in the illustration is used in lifting driving boxes and has proved far superior to the arrangement of chains ordinarily used for that pur-

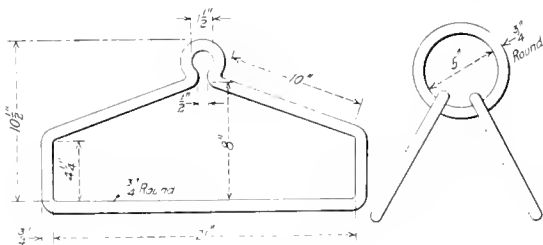

Hook for Lifting Driving Boxes

pose. The device when made with the dimensions shown, is adapted to lifting almost any size of driving box ordinarily encountered, but the dimensions can be varied to suit the sizes of driving boxes and crane hooks.

than he would learn in a year if he were turned loose to do the best he knew how.

Don't allow the tubes to extend $\frac{3}{4}$ in. to one inch outside of the front tube sheet. They are hard to roll and shim and are very inconvenient for the machinist when he is putting in the steam pipes. The tubes should extend outside of the front tube sheet for only about $\frac{1}{4}$ in. and when rolled a quick taper mandrel and pin should be used for all tubes. This will give better holding power to the tube sheet and it

EYE FORMING MACHINE

BY J. H. CHANCY
Foreman Blacksmith, Georgia Railroad, Augusta, Ga.

The machine shown in the illustration is used for bending eyes on brake hangers of various descriptions, rake handles, etc. It is made from bar iron and can be easily constructed in most any shop. A brake cylinder is used to operate it, the air being taken from the shop line. A crosshead on the end

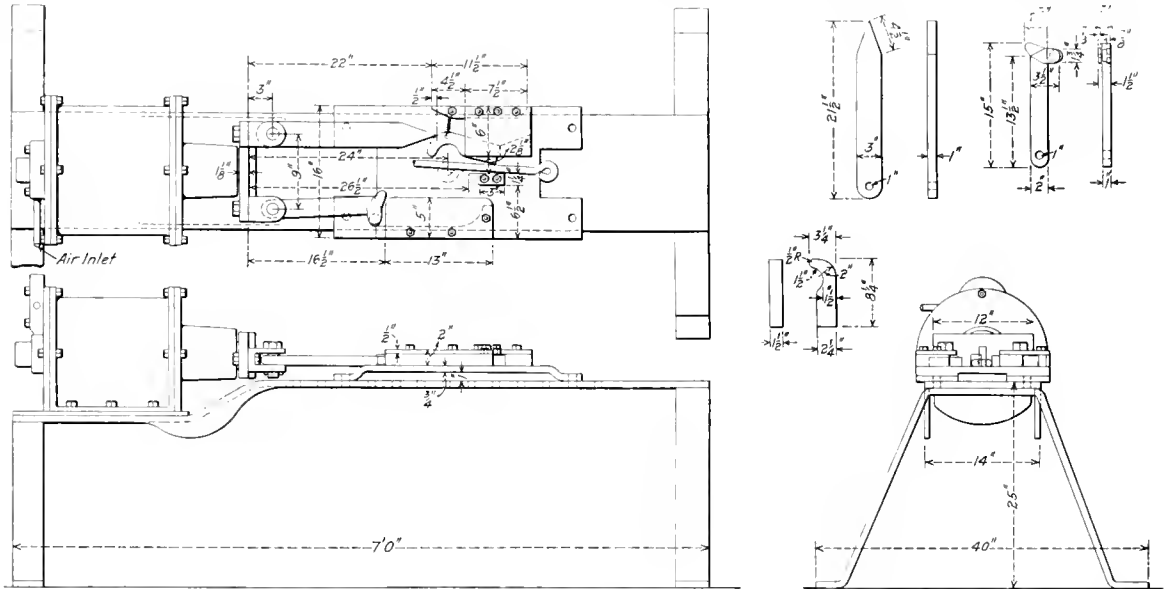

Machine for Forming Eyes on Rods

will save beading the tubes on the front tube sheet in high pressure boilers.

The prosser is the best tool to use when working old tubes in roundhouses. A tube mandrel can also be used. The calking should be done with a pneumatic hammer. The beading tools should not be allowed to become flat. They should be kept in good condition so that they will keep the bead raised up and compact. A roundhouse which has no pneumatic hammer for beading the tubes should be furnished with two prosser expanders, one for $\frac{1}{2}$ -in. sheets and one for $\frac{3}{8}$ -in. sheets as a good many tube sheets become worn and a prosser for $\frac{3}{8}$ -in. sheets is needed. A number of roundhouses use the tube roller, but where this is used the tubes become weak after a short time and cause failures.

When tubes are removed from a boiler 12 of the tube holes in the front tube sheet should be enlarged to $2 \frac{5}{16}$ in. in diameter where 2-in. tubes are used. This would enable the roundhouse boiler makers to take out the tubes easily when necessary as tubes which have run for some months have a heavy scale on them. A piece of $2 \frac{1}{4}$ -in. tube $1 \frac{1}{8}$ in. long will make a good bushing for the enlarged holes. A stretch piece of 2-in. tube $1 \frac{1}{8}$ in. long, large enough to go over the 2-in. tube, can also be used.

MIXTURE OF ACETYLENE AND OXYGEN FOR WELDING.—Theoretically $2 \frac{1}{2}$ volumes of oxygen are required for the complete combustion of one volume of acetylene, but in practice the best welding results are obtained with $1 \frac{1}{2}$ volumes of oxygen to one volume of acetylene. The flame at the burner has in its center a small white cone, at the apex of which the temperature is about 6,000 deg. F., and consists almost entirely of CO, which is being converted at its extremity to CO₂.
—*Institution of Mechanical Engineers.*

of the brake cylinder piston rod carries two arms, both of which are attached to the crosshead by a single bolt, being free to swing. The upper arm shown in the plan slides between a guide fixed in the frame of the machine and a former which bends the rod in which the eye is to be made, around a pin fixed in the bed of the machine. The lower arm then comes in contact with the rod, completing the bend. This arm slides on a guide fixed to the frame of the machine, which is so formed at the further end as to make this arm close the eye. The machine greatly expedites this class of work.

ADVANTAGES OF ELECTRIC LOCOMOTIVES.—In a paper before the New England Railroad Club recently, W. R. Stinemetz of the Westinghouse Electric & Manufacturing Co., enumerated the advantages of electric locomotives as follows: "It eliminates practically all standby losses, the turntable, the delay at water tanks and coaling stations, and its availability for service is much greater, while its maintenance is considerably lower. Its capacity is increased with cold weather, while the reverse is true with the steam engine. Its simplicity of control relieves the crew from many duties necessary on a steam engine, and permits closer observation of track and signals. When properly designed, it is very much easier riding and can have a more uniform distribution of weights with less nosing and track pounding; all of which features tend to lower track maintenance. The one great inherent advantage which the electric locomotive possesses is its ability to concentrate large amounts of horsepower under single control. This locomotive may be in one cab or may be composed of semi-units permanently coupled together. It may have as many motor-driven axles as track structures will permit."

this kind are required, these tools are of great advantage. Where the turning and threading is done in an engine lathe, without the use of such special tools an experienced lathe hand would find it difficult to turn out more than eight or ten in an hour. With these tools a boy is able to turn out about 20 in an hour.

RECLAIMING AIR COMPRESSOR STUFFING BOXES

BY C. W. SCHANE

It is the general practice on nearly all railroads to scrap air compressor stuffing boxes when the threads are worn slightly small, as a great deal of trouble is caused by the packing nuts working off, unless the box is up to the standard size. By the use of the roller expander illustrated below, the stuffing boxes of either Westinghouse or New York air compressors may be reclaimed if the threads are worn small, but

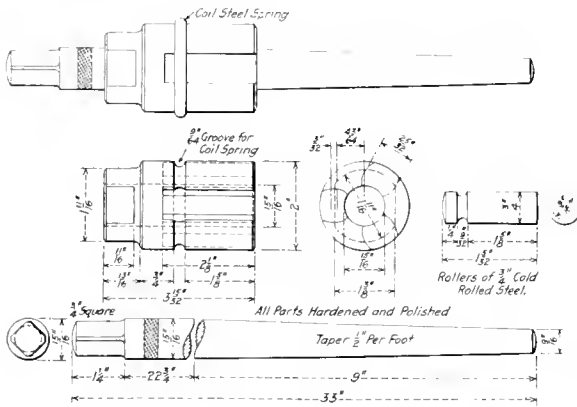

Expander for Reclaiming Air Compressor Stuffing Boxes

the box is otherwise in good condition. The tool of the dimensions shown in the drawing is used on the stuffing boxes of Westinghouse 9½ in. compressors. It is only necessary to expand the box a slight amount and then rechase the threads with a die nut. The reclaimed parts give as good satisfaction as new ones and a considerable saving is effected by this method.

FORMING STRAINER BRASSES

The die shown in the illustration below has been used for some time for forming feed pipe strainer bases. The parts are punched out and formed in one operation, thus effecting a considerable saving in the cost of production. The inner punch *A* is held in position by the annular punch and former *B*. The outer punch is secured by fillister head screws as shown in the dotted lines. In the center of the lower annular surface of the punch *B* are holes in which are fitted the stripper pins *C*. Outside the punch *B* is placed a stripper ring *D*, which is supported and guided by the fillister head screws *E*. The springs used with the stripper ring should be made of ½-in. diameter spring steel to insure forcing the sheet off the punch.

The lower punch is built up on the plate *F*, which carries at its center a bushing *G*. Above this is a block *K*, on which the die *H*, into which the punch *A* works, is set. The die is held down on the block by screws which extend into the base for a short distance. The outer edge of the punch *B* works in connection with the die *J*, which is secured by short fillister head screws sunk flush with the face of the upper block *K*. Between the dies *H* and *J* is a stripper ring *L*, connected by the studs *M*, with the ring *N*, which sets on a

rubber bumper *S*. The lower dies are held together by the screws *P* and the punches and dies are kept in alinement by the pins *R*.

In the operation of the dies the ring *D* clamps the sheet to the lower dies. The circular punch *A* cuts out the center portion, then the outer punch *B* cuts a ring from the sheet. As the dies descend the ring is held in the annular space and

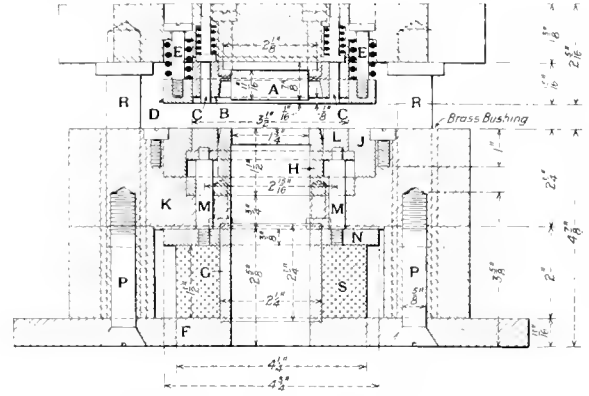

Die for Forming Feed Pipe Strainer Brasses

the inner portion is crimped up between the punch *B* and the die *H*. As the dies separate, the ring *L* raises the finished strainer base until it is flush with the block *K*, and can readily be removed. The stripper pins *C* and the stripper ring *D* force the base and the strip from which it was formed off the punch *B*. Only sufficient clearance for the sheet should be left between the die *B* and the ring *L* when the upper dies are at the lowest point. The strainer bases are formed by this device at a very rapid rate and with no variation in size or form.

PORTABLE TRUCK WHEEL GRINDER

BY F. OSBOURNE

After building up flat stops on tires by the acetylene welding process, it is necessary to chip and file the weld to fit the tire gage. The weld in most cases is very hard and it takes a great deal of time to chip and file it and also a large number of files are worn out. The sketch shows a portable grinder which is used for this purpose. It is free

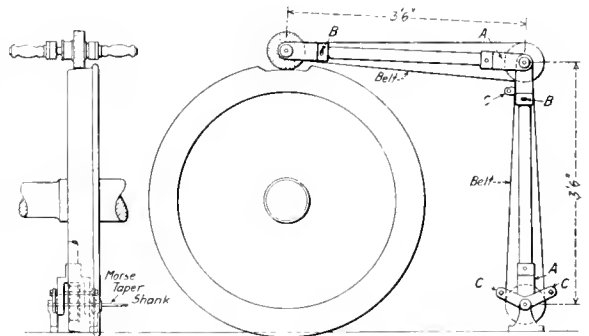

Portable Truck Wheel Grinder

to swing up and down on the brackets, *AA*; it can move forward or backward, and it can be turned slightly about both the vertical and horizontal arms by virtue of the slotted holes *BB*. This device is belt driven and power is supplied by air or electric motors. When not in use the arms rest on stops *CC*.

New Devices

HEAVY SERVICE PLAIN GRINDING MACHINE

The plain grinding machine shown in the illustration, built by the Brown & Sharpe Manufacturing Company, Providence, R. I., embodies several improvements in design, chief among which is the employment of quick change gear mechanisms in the drive for the work spindle and the table traverse. This gives a smooth, positive drive, and permits the speeds or feeds to be changed quickly. The application of chain drive from the work spindle gear case to the jack shaft and again in the head stock eliminates the slipping of belts when running at the low speeds necessary on work of large diameter. The machines are designed to embody all

the power to the driving plate on the spindle. The pulley *K* drives the change gear mechanism controlling the table traverse when the clutch *P* is engaged. The work spindle and table may be stopped independently of the wheel and the pump by the operation of the lever *L*.

The lever *a* and the index slide *b* control the quick change gears. To obtain the desired speed the lever *a* is dropped, the index slide *b* is moved to the desired speed, as indicated on the plate above it, and the lever *a*, is again raised. A plunger pin in the lever *a* locks the gears in position. The lever *c* controls the fast and slow speed gears and other change gears are operated relative to them.

The quick change gears for the table feed are operated in a similar manner, the lever *f* controlling the fast and slow

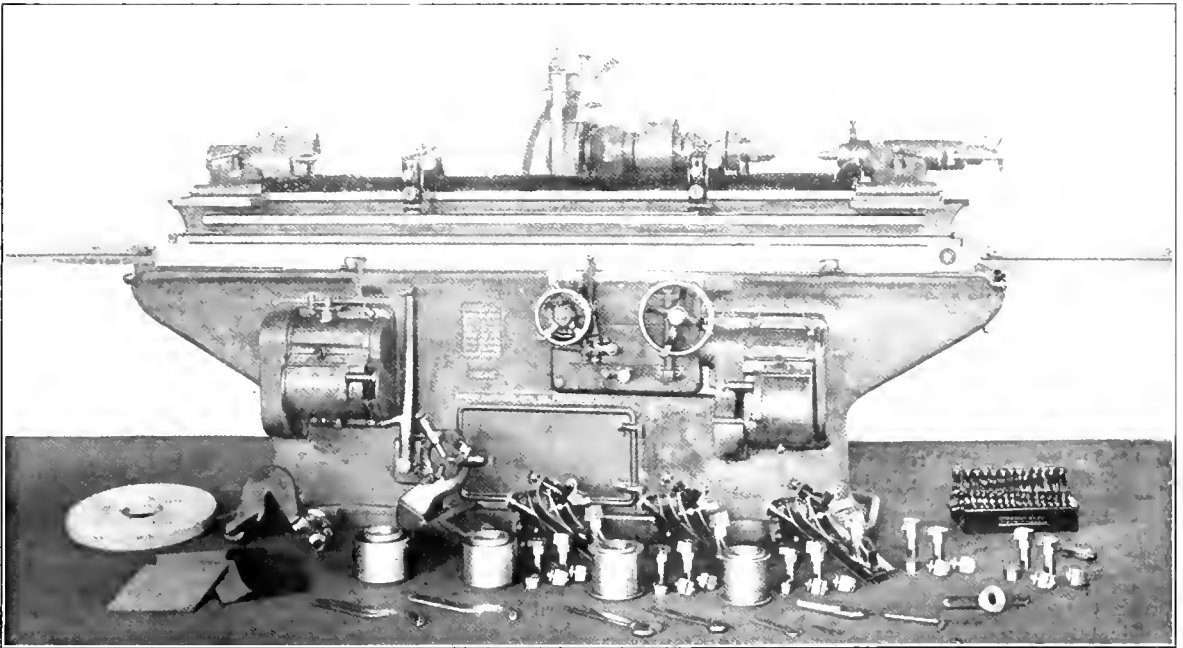

Fig. 1. Plain Grinding Machine for Heavy Work

the features necessary in a plain grinding machine designed for heavy work.

The power is transmitted from the countershaft to the loose pulley *B* (Fig. 2) on the shaft *A*, which runs at a constant speed, operating the work spindle, table traverse, and pump. When the lever *L* is thrown over, causing the clutch *P* to engage with the pulley *B*, the pulley *C* which revolves with the friction clutch *P*, drives the pulley *D* in the change gear case. From the pulley *D* the power is transmitted through the change gears and the chain *G*, to the jack shaft *F* at the rear of the machine, and then to the overhead drum from the pulley *H*. From the overhead drum a belt leads to a pulley on a small jack shaft in the head-stock and a reducing sprocket and chain in the ratio of 1 to 3 transmits

speeds, while the lever *d* and the index slide *e* govern the other gear changes. The table may be traversed by hand with the handwheel *g* which can be disengaged when the automatic feed is used. The operation of the reversing mechanism is such that the machine may be used for grinding close to shoulders.

Tapers are ground by swivelling the table on a stud. A scale graduated to indicate the taper in inches per foot, in degrees, and in percent is located at the end of the table to facilitate setting for any taper.

The feed of the wheel is controlled from the front of the machine either by hand or automatically and may be adjusted to give a feed varying from .00025 in. to .004 in. at one or both reversals of the table. The table may be locked

positively against longitudinal feed and the wheel fed in when grinding narrow surfaces. The wheel spindle runs in self-aligning bearings, and is constructed to support a heavy wheel running at a high rate of speed. There are four wheel spindle speeds, varying from 1,000 to 1,700 r. p. m., which are changed without removing the belt by loosening a lock nut and changing a split pulley on the wheel spindle. Water

packing the journal box, nor does it have to be removed for inspection of the journal. The waste packing can be adjusted with the waste check in place, and it holds the waste where it is most needed. Where this waste check is used there is less liability of waste being removed from the journal boxes for lighting fires, etc., while cars are on sidings, which is an item to be considered, as where this is done not only is the waste lost, but the journal bearing suffers. With the high cost of waste and oil, the use of this device will save expense as less waste and oil will have to be used. This device has been used on a number of railroads with success.

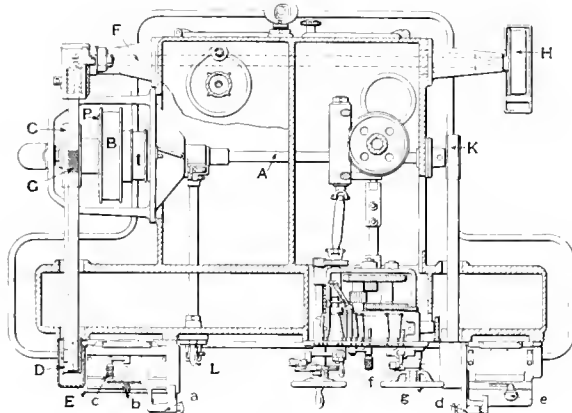

Fig. 2. Sectional Plan of Plain Grinding Machine

is forced to the wheel at the cutting point by the centrifugal pump which, with the tank, is inside the bed of the machine, yet readily accessible. The pump is belted from the pulley *I* on the shaft *A*, and runs at a constant rate of speed, irrespective of the speed of other parts of the machine.

This type of plain grinding machine is manufactured in three sizes, of which the one shown in Fig. 1 is the largest. It will accommodate work 10 in. in diameter and 72 in. in length, while the next smaller size can be used on work 10 in. in diameter and 48 in. long. The smallest size will take work 8 in. in diameter and 36 in. in length.

JOURNAL BOX WASTE CHECK

The illustration shows a simple and effective device for keeping the waste in journal boxes in position where it belongs on the under side of the journal. It is made by the Ideal Waste Check Company, Box 487, Philadelphia, Pa. By its use the oil saturated waste plug which is ordi-

BOILER TUBE TESTING MACHINE

A new testing machine for subjecting boiler and other tubing to internal hydrostatic pressure, has been placed on the market recently by the Watson Stillman Company, New York. The machine is designed to be used either with a hand or power driven pump, so that it is adaptable to large and small shops. The machine consists of a frame with two rectangular tie bars, at one end of which is a stationary abutment; at the other end there is a moving abutment in the shape of a carriage mounted on rollers, which can be adjusted to the length of the tubes to be tested and then secured to the side frames by pins. A high pressure hydraulic pump is used to provide the hydraulic pressure.

The tube to be tested is placed in the machine with one end against the fixed abutment, the moving abutment is then brought to bear against the other end of the tube, and is

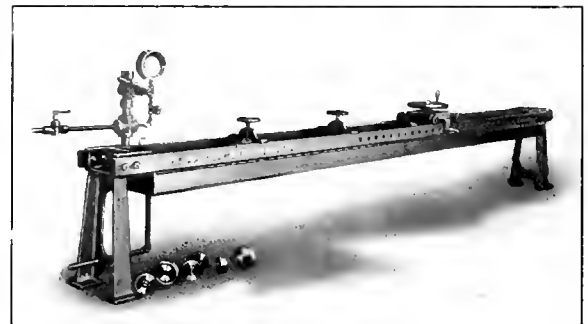

Boiler Tube Testing Machine

pinned to the frame. The tube is then made pressure tight by turning the hand wheel. Two intermediate clamps operated by small hand wheels prevent the tube from buckling while under pressure. The tube is filled from a water main, overhead tank or by low pressure pump. A high pressure hand or power pump is used to raise the pressure to the desired test, as shown on the gage. A pan is provided under the bed of the machine, to catch the waste water which will serve also as a reservoir if a pump is used for the initial filling.

The machine illustrated is designed to test boiler tubes up to 4 1/4 in. outside diameter to a pressure of 1,200 lb. per sq. in. The minimum opening is 5 ft. and the maximum opening 15 ft. The weight of the machine is 2,000 lb. Other sizes to meet special requirements can be built, using the same general design.

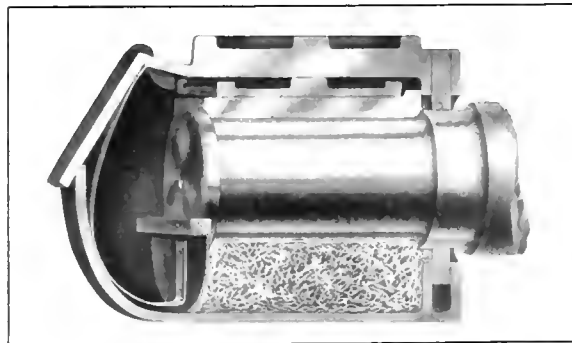

Journal Box Waste Check

narily used to hold the waste in position underneath the journal), is eliminated and with it a source of hot box troubles. This device is of simple construction, being made of pressed steel with a wooden strip which bears against the end of the axle. Its application does not interfere with

EXPANSION OF STEAM LINES.—Expansion in a steam line may be found by the rule, $E = \frac{(L \times 12) \cdot (T - t)}{150,000}$, where E = the expansion in inches, L = the length of the line in feet, which is multiplied by 12 to reduce to inches or $(L \times 12)$, T = the temperature of the pipe when heated, t = the original temperature of the pipe.—Power.

TWENTY-INCH CRANK SHAPER

A shaping machine which has an actual stroke of $20\frac{3}{4}$ in. has recently been placed on the market by the Hendey Machine Company, Torrington, Conn. This machine has a speed of ram ranging from 8 to 115 strokes per minute. The table has a top face 16 in. by 20 in. and a side face of $16\frac{1}{4}$ in. by 15 in., and a horizontal travel of $24\frac{1}{2}$ in. and a vertical travel of 15 in. The vise is provided with a graduated base and has an opening of 13 in. It is held to the table by four T-bolts. A lug is cast on the under side of the vise to give it additional support when heavy cuts are taken.

The table has an adjustable bottom support which slides on a channel-shaped track so arranged as to protect it from the chips and dirt from the machine, which is liable to throw the table out of alignment. It has a power cross feed giving .008 to .200 in. feed per stroke.

The frame and base of the machine are cast in one piece. An oil pan is provided on the inside of the base, which catches all the drip from the bearings and keeps the floor surrounding

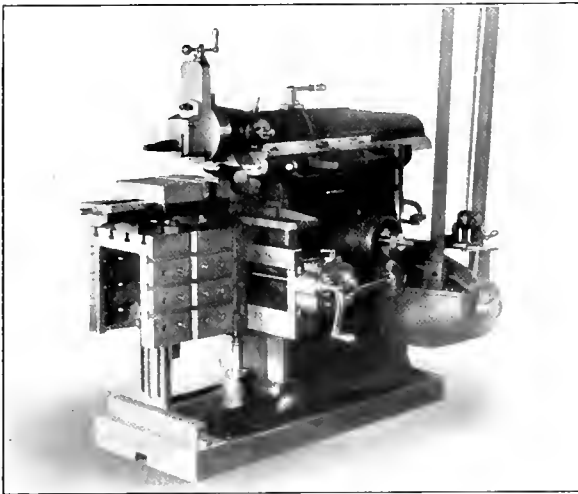

Hendey 20-In. Crank Shaper

the machine clean. The bull gear hub is cast solid with the frame, and it is amply proportioned to withstand all strains arising from heavy cuts. The crank pin and crank pin block are hardened and ground on the wearing surfaces, and the crank pin block is bushed with a cast iron sleeve for the crank pin bearing. The ways for the ram in the frame have an angle of 50 deg. They are planed directly from the solid metal. The gib is combined with the cap in one casting, which makes it rigid, at the same time allowing for adjustment in a horizontal direction. The ram bearing in the frame is $11\frac{1}{4}$ in. by 34 in. The ram can be set in any position while the machine is in motion or idle, the length of the stroke being shown on the index.

The cross feed mechanism is operated entirely at the end of the cross rail. A dial with an indicator controls the amount of feed, and it can be varied while the machine is in motion. The ball lever at the top of the ram casting throws the feed in or out and in either direction, and may be operated while the machine is in motion. The tool head is bound to the head of the ram by a single screw. It is provided with a micrometer dial reading to thousands of an inch and is provided with a power feed.

The machine may be operated either by belt or motor drive. When belt driven it is provided with a driving cone having four steps. The driving cone shaft has an outboard bearing in the end of the casting, which also forms a guard for the

belt. The machine is thrown in and out of gear by the long horizontal lever shown at the side of the frame, which operates an expanding friction clutch of large diameter. The shaper is back-gearred, which with the four steps on the cone gives eight speeds. When motor driven, an adjustable speed motor of about five horse-power running from 400 to 1,200 r.p.m. can be used. The transmission from the motor to the power shaft is by silent chain drive. The machine has a net weight of 4,100 lb. and occupies a floor space of 54 in. by 92 in.

HORIZONTAL BORING, MILLING AND DRILLING MACHINE

A machine of unusual design for heavy boring, milling and drilling is shown in the photograph. As will be noted in Fig. 1, a motor is mounted on the main column for direct motor drive and is connected to a main driving shaft running vertically in the main column. A boring bar, together with the necessary gearing and control is located in a saddle, and the power is transmitted from the vertical drive shaft or spindle in the saddle through a pair of friction cone clutches, located at the back of the saddle, which makes it accessible for adjustment.

This machine, designed by the Landis Tool Company of Waynesboro, Pa., is equipped with rapid power traverse, independent of regular feeds, that will move the column at right angles to the bed plate and also move the saddle up and down on the column. The feed gearing is all contained in the saddle. Horizontal travel of the boring bar is secured by what is called a concentric screw feed feature. Worm

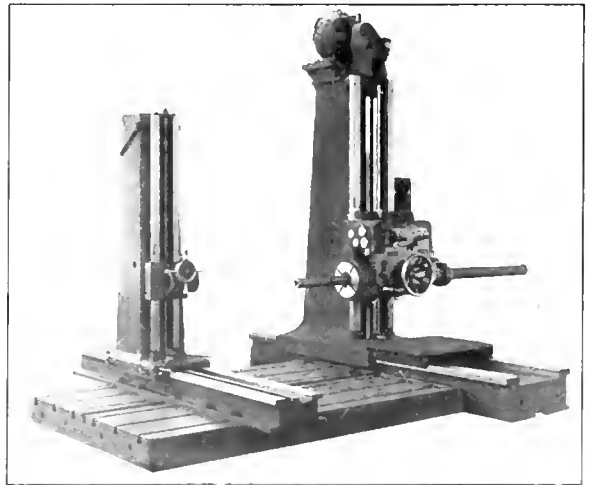

Fig. 1—View Showing Motor Drive on Main Column, Also Independent Column with Sliding Rest

threadways have been cut in the end of the boring bar and there is a clutch with a thread of similar form that can be made to close about and catch on the threaded end of the bar by means of one of the control levers on the outside of the saddle. This feature eliminates the rack and pinion drive with its consequent chattering.

The gear shifts shown in Figs. 2 and 3 are all of the enclosed, sliding transmission type, somewhat similar to the transmission of an automobile. There are 12 changes of speed and 12 changes of feed and a combination of these changes gives a total of 144 actual feed speeds. No two changes of gears can be engaged at the same time, thus eliminating any possibility of stripping the threads. The gears and shifts are made of special heat-treated chrome-nickel steel. The spindle is of high carbon hammered crucible steel.

and ground to secure correct alinement. A syphon oiling system furnishes a continuous supply of oil to the bearings in the saddle. A counterweight for the saddle operates inside of the column and out of the way of the operator.

An independent column is provided with a steady rest

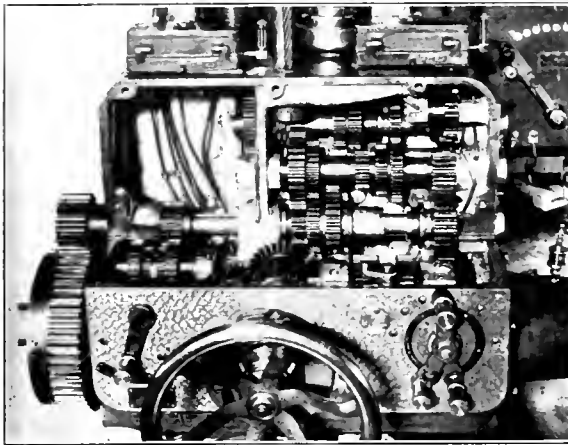

Fig. 2—Part of Gear Box Removed Showing Sliding Transmission

for the boring bar when unusually accurate results or long cuts are desired. An adjustable dial, graduated to thousandths of an inch is provided to be used in connection with the spindle and scales, and verniers also reading to thou-

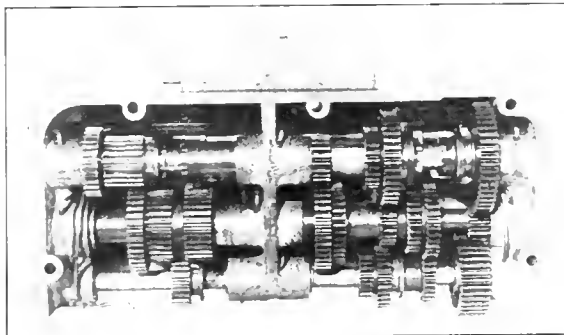

Fig. 3—A Part of the Sliding Transmission That Remains in the Removable Part of the Gear Box

sandths are provided for locating either the main or outer support saddles and columns in desired positions.

This machine will handle a wide range of heavy work and is especially adapted for all classes of milling, drilling and boring in ship yards, navy yards, locomotive shops, etc.

CARS AND LOCOMOTIVES ORDERED IN MARCH.—The orders for cars and locomotives in March were rather below the level set for the months immediately preceding. The locomotive purchases in particular fell off. The freight car buying, however, is fairly active, there being several important inquiries for cars now pending. The totals for the month follow:

	Locomotives	Freight Cars	Passenger Cars
Domestic	298	8,232	572
Foreign	4	2,059	—
Total	302	10,292	572

The total of 572 passenger cars includes, among other orders, 477 subway cars ordered by the Interborough Rapid Transit Company, 50 cars ordered by the Philadelphia & Reading and 41 ordered by the Southern Pacific.

ARTICULATED TENDER TRUCKS

A pedestal truck that has all the advantages of the common pedestal truck and eliminates the wear on the pedestals and journal boxes has been developed recently by the Economy Devices Corporation, 30 Church street, New York City. It also permits the use of the standard M. C. B. journal box. This truck is made in two types; one is designed for passenger and fast freight service and the other for freight and switching service. Both are shown in the illustrations. The journal box and pedestal wear is overcome by pivoting the boxes to the side frame. Triple coil springs placed directly over the journal boxes support the side frames and relieve them from a large amount of shocks to which they are subjected when they rest directly on the box. This design also brings a larger amount of the truck weight on spring supports.

The spring seat for the triple coil springs is a dish

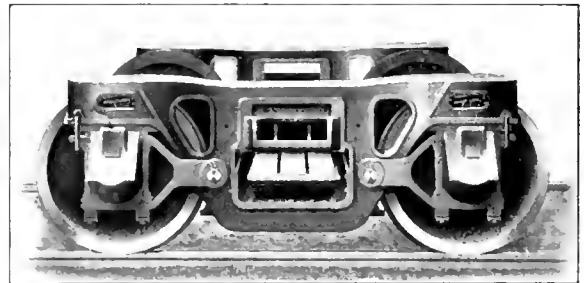

Articulated Truck for Passenger Locomotive Tenders

shaped casting, which is designed to transmit the lateral thrust of the truck to the journal box and thus relieve the pin connection of the journal box yoke from undue strain. This casting has an ample bearing in the side frame and is the part that bears the most wear. A lug with a hole is cast on the upper edge of the spring seat casting. It may be seen in the frame opening above the journal box. When the wheels are to be removed, a rod is passed through this hole to keep the spring seat in position in the side frame when

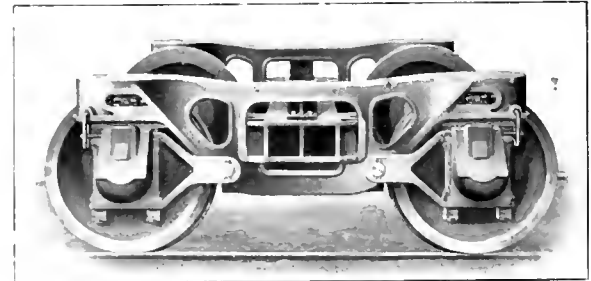

Articulated Truck for Freight Locomotive Tenders

the frame is being jacked up. To remove the wheels, the frame is lifted until the spring seat is free from the journal box. The journal box yoke pin is removed and the wheels are rolled out. This journal box pin must be removed from the inside, and as an additional safeguard the brake hanger must be moved in order to get the pin out of its hole. Thus, while in service, if for any reason the cotter key which holds the pin becomes lost, the pin cannot work out of its hole. The journal box with the yoke attached is removed from the axle by removing the wedge and brass from the journal box and pulling the parts off in a horizontal direction. In no case is it necessary to remove the journal box from the yoke unless either become broken.

The side frames are made of cast steel in channel sections. The journal box yokes are also of cast steel. The trucks are designed to use either lateral motion or rigid bolsters of standard design. The passenger and fast freight trucks are provided with a triple elliptic spring under the bolster and have a spring plank 22 in. wide by 6 in. deep. The trucks for freight and switching service are of the same design and construction as the passenger truck with the exception of the elliptical springs and the spring plank. In this case the bolster is supported directly on the side frames.

ROD PACKING AND SWAB HOLDER

The Paxton-Mitchell Company, Omaha, Neb., has made a slight change in its rod making, to insure the spring which holds the packing segments against the rod being applied in the proper manner. As shown in Fig. 1, a recess is formed

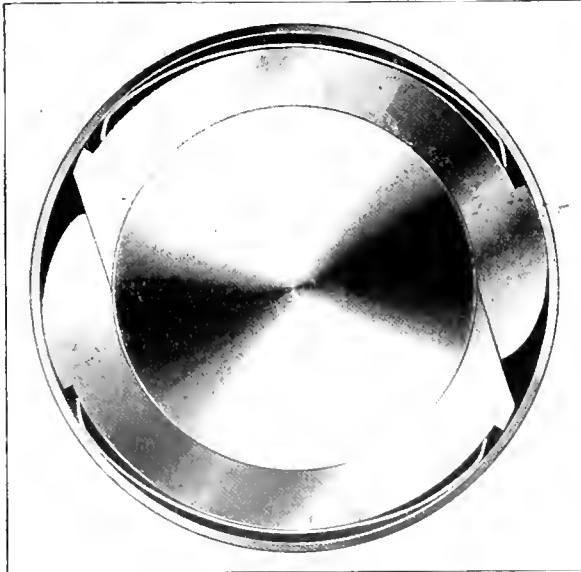

Fig. 1—Improved Type of Paxton-Mitchell Packing

in the outside of the packing segments for the spring, thereby making it impossible to misapply them. The general form of segments has not been changed and they operate the same as before. It is claimed that the segments for superheater

locomotives are made of a material that will stand over 1,000 deg. F., and further, that the wear on the rod is no greater than that with saturated steam packing.

This company has also developed a new air-cooled swab holder that has been found to give especially good service. It is shown in Fig. 2. It is made of brass and was designed primarily for superheater locomotives where the high temperature is liable to destroy the lubricating qualities of the swab. The new holder has fins on the outside face as shown in the illustration, which increases the radiating surface and thus carries away the heat from the swab. Lugs cast on the back of the holder provide a 3/8-in. air space between it and the gland. This also assists in dissipating the heat. With this swab holder on a superheater Mikado locomotive it has been possible to keep the swab in use for two months with satisfactory results.

HANNA PNEUMATIC RIVETING MACHINE

In the illustration below is shown a new type of Hanna pneumatic riveter sold by the Vulcan Engineering Sales Company, Chicago, which is designed especially for operations where the space for the stationary die is limited. The lower stake or nose is removable and can be shaped to whatever form is best adapted to the work being handled.

The mechanism is of the regulation Hanna type, which

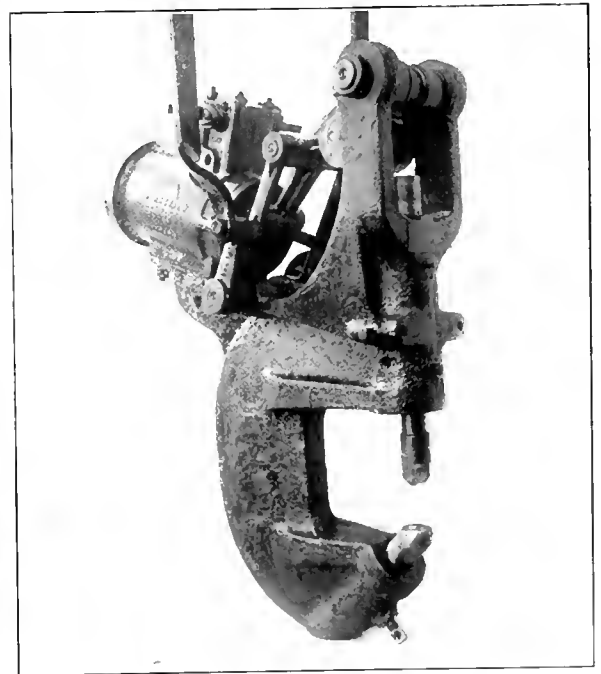

New Type of Hanna Riveter

employs a combination of toggle and lever movements of the dies. This has the advantage of permitting a large opening of the dies with a gradual increase in the amount of pressure applied as the dies close until the desired amount is secured, the pressure through the remainder of the stroke remaining practically constant. As the rated maximum pressure is exerted through a relatively large space, the necessity for adjustment to take care of ordinary variations in rivet length, diameter of hole or thickness of plate is done away with after the machine has once been set.

This machine exerts a maximum pressure of 30 tons, and

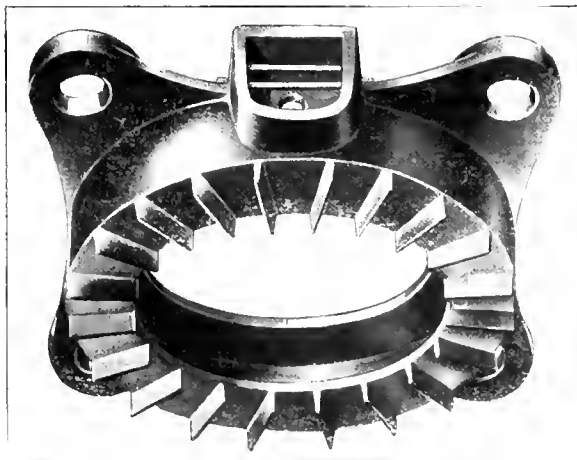
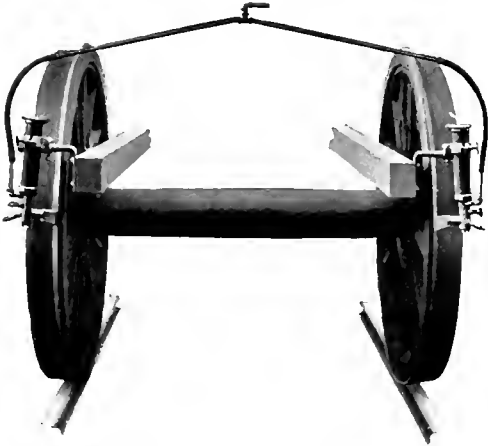

Fig. 2—Swab Holder Designed Especially for Superheater Locomotives

is adapted to driving 3/4-in. rivets in structural work, or 1/2-in. rivets where steam tight joints are required. It has a 12-in. reach and 12-in. gap, with a die travel of 4 in. The cylinder is 10 1/2 in. in diameter. The machine is intended to work with an air pressure of 100 lb. per square inch. It is designed to be suspended from a crane and can be balanced so that rivets can be driven at any angle. Various sizes are built to meet the requirements of boiler, tank and structural work.

SWANSON AUTOMATIC FLANGE LUBRICATOR

A number of railroads in Colorado are now using a flange lubricator which is manufactured by the Swanson Automatic Flange Lubricator Company, Denver, Colo. The illustration shows the method of application. The body of the lubricator is pivoted near the center to allow the feed shoes to follow the lateral movement of the wheels. The reservoir is filled at the end of each run with car oil, and the device will then require no attention over the division. The amount of oil fed is regulated by a plunger in the feed shoe, which is operated by the vibration of the wheel against it. When the engine stops the feed of oil is practically shut off. If



Swanson Flange Lubricator Applied with Heater Pipes

it is desired to stop the flow of oil entirely this can be done by closing a small valve near the outlet. Sediment spaces are provided in the oil passages, and these can readily be cleaned by removing plugs. A heater which utilizes steam from the air pump exhaust is provided on each lubricator. The feed shoe is the only part which is subjected to wear, and it is claimed that the cost of replacement is very low. This device has been applied to engines of various types, and can also be used on cars if desired.

WAR SCRAP.—An article in a recent issue of the *Compressed Air Magazine* calls attention in a striking manner to the vast amount of steel which is being consumed in the military operations of the warring European nations. Taking the contested area in front of Verdun, and assuming that an average of a million shells per week were used by each of the opposing armies during the battle, which raged for some 30 weeks, a total of some 60,000,000 shells were thrown. On the basis of an average weight per shell of 100 lb., this means that a total of 3,000,000 tons of steel were thrown upon a disputed area estimated to be about 100 sq. miles, or 64,000 acres. Therefore, an average weight of steel of about 47 tons is somewhere under the surface of each acre of ground, which may have a scrap value as high as \$20 per ton.

ROLLER LOCK NUT

A new type of lock nut of unique construction has been placed on the market recently. It has a small roller which operates in the annular space on the outer face of the nut, being held in position by a band, as shown in the illustration. This roller acts between the threads on the bolt and against the cam-shaped surface in the annular recess of the nut. It is covered by a tool steel retaining ring, part of which is cut away in the illustration to show the construction of the nut. As this nut is screwed on to the bolt, the roller will ride between the threads, offering no resistance whatever. As the nut turns in the opposite direction, however, the roller will jam in between the threads and the cam in the nut, preventing it from working off the bolt. To remove the nut, a sharp, quick twist is given the nut by an ordinary wrench. This



Roller Lock Nut

forces the roller over into the recess just ahead of the cam. With the roller in this recess, the nut is easily removed. As soon as the nut has been removed from the bolt the roller returns to its original position and the nut is ready for re-application.

The principal advantages of this type of lock nut are that with any vibration or working in service it is free to tighten up, but cannot turn back, and therefore tends to become tighter with recurring vibration. The bolt to which it is applied does not need to be any longer than one used with an ordinary nut without a washer or nut lock. This device has been in test service for a period of over two years. Two railroads have made extensive trials of the nut in track and on rolling stock. Tests are now in effect on the New Haven, the New York Central, the Central Railroad of New Jersey, the Pennsylvania, the Lehigh Valley and the Erie. This lock nut is manufactured by the Roller Nut Lock Company, New York.

KILLED BY CARBON MONOXIDE.—An instructive case of doing things the way they ought not to be done was that of a boiler maker and his helper at Goulburn, N. S. W. According to a report in the *Australian Mining Standard*, they entered the water tank of a locomotive tender through the manhole, and as the weather was cold, they took a drum of live coals with them. Some hours later both were found lying dead at the bottom of the tank, having been killed by carbon monoxide.—*Power*.

Railway Mechanical Engineer

(Formerly the RAILWAY AGE GAZETTE, MECHANICAL EDITION
with which the AMERICAN ENGINEER was incorporated)

PUBLISHED ON THE FIRST THURSDAY OF EVERY MONTH BY THE
SIMMONS-BOARDMAN PUBLISHING COMPANY

EDWARD A. SIMMONS, *President* L. B. SHERMAN, *Vice-President*
HENRY LEE, *Vice-President and Treasurer* M. H. WIUM, *Secretary*
WOOLWORTH BUILDING, NEW YORK, N. Y.
F. H. THOMPSON, *Business Manager*, CHICAGO.

Chicago: Transportation Bldg. Cleveland: Citizens' Bldg.
Washington: Home Life Bldg.
London: Queen Anne's Chambers, Westminster.

ROY V. WRIGHT, *Editor*
R. E. THAYER, *Managing Editor*

C. B. PECK, *Associate Editor* A. F. STUEBING, *Associate Editor*

Entered at the Post Office at New York, N. Y., as mail matter of the second class.

Subscriptions, including the eight daily editions of the *Railway Age Gazette* published in June in connection with the annual conventions of the Master Car Builders' and American Railway Master Mechanics' Associations, payable in advance and postage free: United States, Canada and Mexico, \$2.00 a year; Foreign Countries (excepting daily editions), \$3.00 a year; Single Copy, 20 cents.

WE GUARANTEE, that of this issue 8,800 copies were printed; that of these 8,800 copies, 7,621 were mailed to regular paid subscribers, 108 were provided for counter and news companies' sales, 535 were mailed to advertisers, exchanges and correspondents, and 536 were provided for new subscriptions, samples, copies lost in the mail and office use; that the total copies printed this year to date were 35,972, an average of 8,993 copies a month.

The RAILWAY MECHANICAL ENGINEER is a member of the Associated Business Papers (A. B. P.) and of the Audit Bureau of Circulations (A. B. C.).

VOLUME 91

APRIL, 1917

NUMBER 4

CONTENTS

EDITORIALS:

Locomotive Rod Job Competition.....	173
Collision Shocks on Steel Equipment.....	173
Application of Safety Appliances.....	173
Bills of Material.....	173
An Additional Incentive for Fuel Economy.....	173
Efficiency of Motive Power.....	174
Improving Roundhouse Facilities.....	174
The Valuation of Rolling Stock.....	175
New Books.....	175

COMMUNICATIONS:

Altering Locomotive Front Ends.....	176
Tobesura Weno "On the Mat".....	176

GENERAL:

Pennsylvania Locomotive Tests.....	177
Rail Pressure from Main Rod Thrust.....	181
Spanish Passenger Locomotives.....	183
Electric Locomotive Operation.....	186
Mount Union Collision.....	187
Pulverized Coal Plant for the Santa Fe.....	187
Hearing on Safety Appliances.....	188

CAR DEPARTMENT:

Train Line Maintenance.....	189
Pennsylvania 85-Ton Hopper Cars.....	191
"One Coat" Paint for Freight Cars.....	193
Making a Car Inspector.....	194
Reinforcing Freight Car Draft Sills.....	195
Hot Boxes Reduced by Following Instructions.....	197
Carelessness and Ignorance Responsible for Hot Boxes.....	197
Why Not Have Car Department Apprentices?.....	198
Passenger Car Foundation Brake Rigging.....	199

SHOP PRACTICE:

Master Painters Toll of Benefits from Convention Attendance.....	201
Purifying Shop Drinking Water.....	202
Electrical Equipment Repair Shops.....	203
Making "Stickers".....	206
Modern Railway Shop Lighting.....	207
Hooks for Lifting Driving Boxes.....	209
Renewing Boiler Tubes.....	209
Eye Forming Machine.....	210
Air Valve Facing Machine.....	211
Spring Support for Pyrometer.....	211
Tools for Turning and Threading Small Screws.....	211
Reclaiming Air Compressor Stuffing Boxes.....	212
Forming Feed Pipe Strainer Brasses.....	212
Portable Truck Wheel Grinder.....	212

NEW DEVICES:

Heavy Service Plain Grinding Machine.....	213
Journal Box Waste Check.....	214
Boiler Tube Testing Machine.....	214
Twenty Inch Crank Shaper.....	215
Horizontal Boring, Milling and Drilling Machine.....	215
Articulated Tender Trucks.....	216
Rod Packing and Swab Hobbler.....	217
Hanna Pneumatic Riveting Machine.....	217
Swanson Automatic Flange Lubricator.....	218
Roller Lock Nut.....	218

NEWS DEPARTMENT:

Notes.....	219
Meetings and Conventions.....	220
Personal Mention.....	220
Supply Trade Notes.....	222
Catalogues.....	226

A large number of men in the shops of the Western Maryland at Hagerstown, Md., struck last week for an increase in pay.

The Lehigh Valley has made an advance of two cents an hour in the pay of machinists, boilermakers and car repairers at Hazleton, Weatherly, Mount Carmel and Delano. The increases are in line with those recently made at Easton and Sayre.

Following conferences with the management lasting several weeks, 1,400 employees of the car repair department of the Chicago & Eastern Illinois were granted an average increase in wages of one and one-half cents an hour. The advance is retroactive from January 1, 1917.

The Pittsburgh Railway Club is taking an active part in helping the Pittsburgh Chapter of the American Red Cross secure an enrollment of 25,000 members. In accordance

with a decision made at the meeting March 26 enrollment blanks have been sent to all the club's members, and they are now busily getting names for the Red Cross. J. Rogers Flannery is chairman of the Pittsburgh Chapter.

The United States Senate on February 13 voted against increasing the postal rates on magazines and newspapers. An amendment to the post office appropriation bill, making the increase, was stricken out of the bill in the debate in the Senate on February 10, on a point of order; and later an effort was made to secure its restoration, under suspension of the rules of the Senate, but the effort failed. This, apparently, settles the matter for the present session.

The shopmen's unions on 20 of the principal western railroads have asked to have their pay increased 10 cents an hour, and to have the workday reduced to eight hours. These unions were granted an increase in pay, following the

negotiations of last autumn, and their day was reduced to nine hours. An officer of the Rock Island lines says that if the new demands are granted, the additional expense on his lines will amount annually to nearly \$3,000,000.

MEETINGS AND CONVENTIONS

Tool Foremen's Association.—The 1917 convention of the Railway Tool Foremen's Association will be held in Chicago, August 30 to September 1, inclusive.

Car Inspectors' and Car Foremen's Association.—The 1917 convention of the Chief Interchange Car Inspectors' and Car Foremen's Association will be held in St. Louis, Mo., September 25, 26 and 27.

The June Mechanical Conventions.—At the first assignment of space for the Railway Supply Manufacturers' Association exhibit at Atlantic City, June 13 to 20, 70,000 sq. ft. of space was assigned to 200 companies. This amount is already almost as great as the total space used last year. Several new exhibitors have taken space, a large number of regular exhibitors have enlarged their booths and the machine tool builders will have a large representation. There is, therefore, every indication that the exhibit this year will be a record-breaker. Several important improvements have been made on the pier. Machinery Hall Extension has had a ceiling put in it, and the north side of the Annex in front of the cottage has been fitted with glass panels.

The following list gives names of secretaries, dates of next or regular meetings and places of meeting of mechanical associations:

- AIR BRAKE ASSOCIATION.—F. M. Nellis, Room 3014, 165 Broadway, New York City. Convention, May 1-4, 1917, Memphis, Tenn.
- AMERICAN RAILROAD MASTER TINNERS', COPPERSMITHS' AND PIPEFITTERS' ASSOCIATION.—O. E. Schink, 485 W. Fifth St., Peru, Ind.
- AMERICAN RAILWAY MASTER MECHANICS' ASSOCIATION.—W. Taylor, Karpén Building, Chicago. Convention, June 13-15, 1917, Atlantic City, N. J.
- AMERICAN RAILWAY TOOL FOREMEN'S ASSOCIATION.—R. D. Fletcher, Belt Railway, Chicago. Convention, August 30, 31 and September 1, 1917, Hotel Sherman, Chicago.
- AMERICAN SOCIETY FOR TESTING MATERIALS.—Prof. E. Marburg, University of Pennsylvania, Philadelphia, Pa.
- AMERICAN SOCIETY OF MECHANICAL ENGINEERS.—Calvin W. Rice, 29 W. Thirty-ninth St., New York.
- ASSOCIATION OF RAILWAY ELECTRICAL ENGINEERS.—Joseph A. Andreucetti, C. & N. W., Room 411, C. & N. W. Station, Chicago.
- CAR FOREMEN'S ASSOCIATION OF CHICAGO.—Aaron Kline, 841 Lawlor Ave., Chicago. Second Monday in month, except June, July and August, Hotel La Salle, Chicago.
- CHIEF INTERCHANGE CAR INSPECTORS' AND CAR FOREMEN'S ASSOCIATION.—W. R. McMunn, New York Central, Albany, N. Y. Convention, September 25, 26 and 27, 1917, St. Louis, Mo.
- INTERNATIONAL RAILROAD MASTER BLACKSMITHS' ASSOCIATION.—A. L. Woodworth, C. H. & D., Lima, Ohio. Convention, August 21, 1917, Hotel Sherman, Chicago.
- INTERNATIONAL RAILWAY FUEL ASSOCIATION.—J. G. Crawford, 547 W. Jackson Blvd., Chicago. Convention, May, 1917, Chicago.
- INTERNATIONAL RAILWAY GENERAL FOREMEN'S ASSOCIATION.—William Hall, 1126 W. Broadway, Winona, Minn. Convention, September 4-7, Hotel Sherman, Chicago, Ill.
- MASTER BOILERMAKERS' ASSOCIATION.—Harry D. Vought, 95 Liberty St., New York. Convention, May 22-25, 1917, Richmond, Va.
- MASTER CAR BUILDERS' ASSOCIATION.—J. W. Taylor, Karpén Building, Chicago. Convention, June 18-20, 1917, Atlantic City, N. J.
- MASTER CAR AND LOCOMOTIVE PAINTERS' ASSOCIATION OF U. S. AND CANADA.—A. P. Dane, B. & M., Reading, Mass. Convention, September 11, 1917, Hotel La Salle, Chicago.
- NIAGARA FRONTIER CAR MEN'S ASSOCIATION.—E. N. Frankenberger, 623 Brisbane Building, Buffalo, N. Y. Meetings, third Wednesday in month, New York Telephone Bldg., Buffalo, N. Y.
- RAILWAY STOREKEEPERS' ASSOCIATION.—F. Murphy, Box C, Collinwood, Ohio. Convention, May 21-23, 1917, Chicago, Ill.
- TRAVELING ENGINEERS' ASSOCIATION.—W. O. Thompson, N. Y. C. R. R., Cleveland, Ohio.

PERSONAL MENTION

GENERAL

H. R. PENNINGTON has recently been appointed supervisor of electrical equipment of the Rock Island Lines. His duties in this position will cover the supervision of electrical equipment in shops and roundhouses, locomotive headlights, car lighting and electric and gas welding equipment for the entire system. Mr. Pennington entered railway service on the Frisco Lines at Ft. Smith, Ark., in 1909. He was made division electrician of the Illinois division of the Rock Island Lines with headquarters at Rock Island in July, 1910. He occupied this position until May, 1915, when he was promoted to the position of traveling electrical inspector for the system, the position which he occupied at the time of his appointment above noted.



H. R. Pennington

AMOS WILSON has been appointed supervisor of fuel service of the Delaware, Lackawanna & Western with headquarters at Scranton, Pa., succeeding M. C. M. Hatch, resigned. Mr. Wilson was born in England in 1875, coming to Duryea, Pa., in 1880. After graduating from the public schools he was employed in and around the Lackawanna coal mines, where he learned the trade of mine machinist. In 1899 he became a fireman on the Scranton division of the Delaware, Lackawanna & Western and in 1905 was promoted to engine man on the same division. In February 1913, he was appointed special in-



A. Wilson

RAILROAD CLUB MEETINGS

Club	Next Meeting	Title of Paper	Author	Secretary	Address
Canadian	April 13, 1917	Railway Operating Efficiency as Influenced by Material and Supply Accounts	W. Symons	James Powell	P. O. Box 7, St. Lambert, Que.
Central	May 11, 1917	Lubrication of Freight Car Equipment	T. J. Burns	Harry D. Vought	95 Liberty St., New York
Cincinnati	May 8, 1917		W. H. Belnap	H. Boutet	101 Carew Bldg., Cincinnati, Ohio.
New England	April 10, 1917	High Pressure Steam as Applied for Motor Car Service	F. O. Stanley	Wm. Cade, Jr.	683 Atlantic Ave., Boston, Mass.
New York	April 20, 1917	Railway Water Supply	C. R. Knowles	Harry D. Vought	95 Liberty St., New York
Pittsburgh	April 27, 1917	Wanted—A Box Car	A. M. Schrover	J. B. Anderson	207 Pean Station, Pittsburgh, Pa.
Richmond	April 9, 1917			F. O. Robinson	C. & O. Railway, Richmond, Va.
St. Louis	April 13, 1917			A. B. Frauenthal	Unioo Station, St. Louis, Mo.
South'n & Sw'n.	May 19, 1917			A. J. Merrill	Box 1205, Atlanta, Ga.
Western	April 16, 1917	Steel Gondolas vs. Composite Gondolas	Wm. Queenan	Jos. W. Taylor	1112 Karpén Bldg., Chicago, Ill.

structor in the motive power and equipment department, also having charge of progressive examinations of firemen, serving in that capacity until his recent appointment as supervisor of fuel service.

T. H. HAMILTON, heretofore master mechanic of the Canadian Pacific, on the Trenton division, Ontario district at Trenton, has been appointed assistant superintendent, with office at Havelock, succeeding E. J. Melrose, transferred.

I. C. HICKS, master mechanic of the Atchison, Topeka & Santa Fe at San Bernardino, Cal., has been appointed mechanical superintendent of the western district of the Eastern lines, at Topeka, Kan.

F. T. HUSTON, general car inspector of the Pennsylvania Lines West of Pittsburgh, at Ft. Wayne, Ind., has been appointed assistant engineer of motive power, with headquarters at Ft. Wayne.

D. P. KELLOGG, superintendent of shops of the Southern Pacific at Los Angeles, Cal., has been appointed superintendent of motive power at Sacramento, succeeding T. W. Younger, resigned.

J. H. MCGOFF, mechanical superintendent of the Eastern lines of the Atchison, Topeka & Santa Fe, at Topeka, Kan., has been transferred to Fort Madison, Iowa, as mechanical superintendent of the eastern half of the Eastern lines, which have been divided into two districts.

MASTER MECHANICS AND ROAD FOREMEN OF ENGINES

A. G. ARMSTRONG, master mechanic of the Arizona division of the Atchison, Topeka & Santa Fe, Coast Lines, at Needles, Cal., has been transferred as master mechanic to the Los Angeles division, with headquarters at San Bernardino, succeeding I. C. Hicks, promoted.

W. Y. CHERRY, enginehouse foreman of the Pennsylvania Lines West of Pittsburgh at Allegheny, Pa., has been appointed master mechanic of the Grand Rapids & Indiana, with office at Grand Rapids, Mich.

J. W. CUYLER, master mechanic of the Chicago, Rock Island & Pacific at Armourdale, Kan., has been transferred to Herington, Kan., as master mechanic of the Kansas division, succeeding R. J. McQuade, transferred.

GEORGE L. ERMSTROM has been appointed road foreman of engines on the Yellowstone division of the Northern Pacific, with headquarters at Glendive, Mont.

F. H. HARDIN has been appointed master mechanic of the Adirondack division of the New York Central, with headquarters at Utica, N. Y., succeeding C. F. Deaner, assigned to other duties.

J. J. KARIBO, master mechanic of the Cleveland, Cincinnati, Chicago & St. Louis, with office at Mattoon, Ill., has been appointed master mechanic at Bellefontaine, Ohio, succeeding W. J. Frauendiener, resigned.

L. A. MATTHEW has been appointed master mechanic of the Arizona division of the Atchison, Topeka & Santa Fe, Coast Lines, with headquarters at Needles, Cal., succeeding A. G. Armstrong, transferred.

D. J. MCCUAIG, general foreman of the Grand Trunk, at Ottawa, Ont., has been appointed acting master mechanic of the Ontario lines, with headquarters at Toronto, succeeding W. G. Sealy, assigned to other duties.

GEORGE MOTH has been appointed division master mechanic of the Canadian Pacific, with office at Edmonton, Alta., succeeding A. E. Dales, transferred.

T. H. ROOMEX has been made fuel supervisor of the Eastern division of the Texas & Pacific, with headquarters at Marshall, Texas.

F. W. RITVARK, master mechanic of the Baltimore & Ohio at Garret, Ind., has been appointed master mechanic at Cleveland, Ohio, succeeding J. F. Gethins.

A. ROESCH, acting master mechanic of the Colorado & Southern, with office at Denver, Colo., has been appointed master mechanic of the Atchison, Topeka & Santa Fe, with the same headquarters, succeeding J. M. Davis.

A. R. RUTLER, general foreman of locomotives, Chicago, Rock Island & Pacific, at Chicago, Ill., has been appointed master mechanic of the Kansas City Terminal and St. Louis divisions, with headquarters at Armourdale, Kan., succeeding J. W. Cuyler, transferred.

J. R. STELD has been appointed assistant supervisor of fuel service of the Delaware, Lackawanna & Western, with headquarters at Scranton, Pa.

CAR DEPARTMENT

J. M. BORROWDALE, superintendent car department Illinois Central, with headquarters at Chicago, Ill., has resigned, and the office will be abolished temporarily.

SHOP AND ENGINEHOUSE

G. HICKEY, heretofore boiler shop foreman of the Grand Trunk at Toronto, Ont., has been appointed general foreman at that point, succeeding E. Logan, resigned.

ARTHUR W. McLEAN has been appointed general foreman of locomotives of the Chicago, Rock Island & Pacific, at Haileyville, Okla., succeeding Samuel Tolley, resigned.

J. D. MUTR, heretofore locomotive foreman of the Canadian Pacific at Winnipeg, Man., has been appointed general foreman of the locomotive shops, at Vancouver, B. C., succeeding G. H. Keed, superannuated.

A. P. NEFF, general foreman of locomotives of the Southern Pacific at Los Angeles, Cal., has been appointed superintendent of shops at Sacramento, Cal., succeeding O. B. Schoenky, transferred.

PURCHASING AND STOREKEEPING

J. A. BEST has been appointed acting purchasing agent of the Atlanta & West Point and the Western Railway of Alabama, with headquarters at Augusta, Ga., succeeding Robert T. Pace, relieved to devote his time to other duties.

E. LANGHAM, purchasing agent, of the Canadian Northern for the lines west of Port Arthur at Winnipeg, Man., has been appointed general purchasing agent for the system with office at Toronto, Ont. His former position, and that of purchasing agent for the eastern lines have been abolished.

ROBERT T. PACE, has been relieved of his duties as purchasing agent of the Atlanta & West Point and the Western Railway of Alabama, at his own request.

W. J. STURGES, heretofore storekeeper of the Grand Trunk Pacific at Transcona, Man., has been appointed acting assistant purchasing agent at Winnipeg, Man., succeeding A. H. Mulcahey, transferred temporarily to the Imperial Munitions Board.

OBITUARY

CHARLES B. ACKER, general car foreman of the Pittsburg, Shawmut & Northern, died at his home in St. Marys, Pa., on February 21, 1917.

J. F. KEEGAN, superintendent of motive power of the Grand Rapids & Indiana, at Grand Rapids, Mich., died on March 9.

W. C. WALZ, division master mechanic of the Chicago, Burlington & Quincy at Hannibal, Mo., died at that place on March 23.

SUPPLY TRADE NOTES

J. N. Hansen has been elected president of the Middletown Car Company, succeeding Arthur King, deceased.

F. L. Gordon has been elected assistant to the vice-president of the American Brake Shoe & Foundry Company, with headquarters at Chicago.

Luman R. Dewey has been appointed western sales manager of the American Brake Shoe & Foundry Company, with headquarters at Chicago.

The Titanium Alloy Manufacturing Company has moved its New York office from 15 Wall street to the City Investing building, 165 Broadway.

Arthur King, president of the Middletown Car Company, died at his home at Middletown, Pa., on January 31 of heart disease. He was 75 years old.

S. S. Shields, formerly general road foreman of the Atlantic Coast Line, has been appointed mechanical expert of the Galena Signal Oil Company.

The Mott Sand Blast Manufacturing Company, Inc., of New York, will occupy its new plant in the borough of Brooklyn, N. Y., about April 1.

The McCord Manufacturing Company of Detroit will move its New York office from 50 Church street to room 1416 at 165 Broadway, about April 15.

Marburg Brothers, Inc., manufacturers of several railway specialties, will remove its New York office from 1790 Broadway to 90 West street, on April 1.

William C. Dodd, president of the National Lock Washer Company, Newark, N. J., died suddenly at his home in East Orange, N. J., on Monday morning, March 12, 1917. He was 46 years old. Mr. Dodd had been connected with the National Lock Washer Company since 1886. He was secretary and treasurer of the company for many years and succeeded his father as president upon the death of Mr. Dodd, senior, 12 years ago.

Henderson Weir, secretary of the Harlan & Hollingsworth Corporation, Wilmington, Del., died suddenly Sunday, March 4. Mr. Henderson had been connected with this company for about 21 years, during the major part of which period he acted as manager of the car department, looking particularly after the sales end of the business.

The Q & C Company, New York, has opened a branch office in St. Louis, Mo., No. 1942 Railway Exchange building, under the direction of John L. Terry.

After March 15 the Louisville branch of the H. W. Johnson-Manville Company will be located in a new building at the corner of Fourth avenue and Guthrie street.

M. B. Meyers, assistant to the vice-president of the

American Manganese Steel Company, has been appointed sales manager, with headquarters at Chicago, Ill.

W. H. Wood has severed his connection with the Baltimore & Ohio, to enter the employ of the Combustion Engineering Corporation as engineer of tests and research.

L. P. Alford has resigned as editor of the American Machinist to open an office as consulting engineer, and has been succeeded by John H. Van Deventer, managing editor.

William Leighton, formerly with the O'Malley-Bear Valve Company, Chicago, has resigned to take a position with the Oxweld Railroad Service Co., Railway Exchange building, Chicago.

Harlow A. Varney has been appointed manager of the railroad department of the Paige & Jones Chemical Company, of New York City, with headquarters at Chicago.

Mr. Varney was born at Spencer, Ia., September 9, 1887. After leaving high school at Spencer he attended the Iowa State College at Ames, Ia. He began his career in the railway supply field with the Julian L. Yale Company in 1907, leaving this concern in 1910 to enter the employ of the National Boiler Washing Company as general sales manager. After five years with this latter company he was appointed manager of the railroad department for the Smith-Totman Company, later becoming secretary and treasurer of the company. He now becomes manager of the railroad department for Paige & Jones Company, his territory covering the United States and Canada.



H. A. Varney

The Burdett Oxygen Company will complete the erection of its Salt Lake City, Utah, plant on March 1. The capacity of the Los Angeles, Calif., plant has also recently been increased 50 per cent.

James McNaughton, who recently resigned from the vice-presidency of the American Locomotive Company, has been appointed assistant to the president of the Eddystone Ammunition Corporation.

The Independent Pneumatic Tool Company, Chicago, Ill., held its annual sales convention on February 28, and March 1. The first day's meeting was held at the company's factory at Aurora, Ill.

Alexander P. Robinson, formerly vice-president and treasurer of the Cambria Steel Company, died at his home in New York on February 16 from hardening of the arteries, aged 53 years.

Frank N. Grigg, of Richmond, Va., several years representative of the Harlan & Hollingsworth Corporation in southern territory, has been elected secretary of the corporation, succeeding Henderson Weir, deceased.

F. Lloyd Mark, who for the past year has operated a sales engineering business in Chicago, Ill., has been appointed western sales manager of the Stroh Steel-Hardening Process Company, with headquarters in the same city.

E. P. Dillon, formerly assistant to manager of the railway and lighting department of the Westinghouse Electric & Manufacturing Company at East Pittsburgh, has been



W. C. Dodd

appointed manager of the power division of the New York office.

William T. Thompson, superintendent of the car department of the Harlan & Hollingsworth Corporation, has been made manager of the car department. Mr. Thompson has been connected with the company for many years.

The Jerome-Edwards Metallic Packing Company, Chicago, on March 1, 1917, discontinued its offices in the Railway Exchange building. Its general offices are now located at the factory, 320-328 North May street, Chicago.

W. S. Rugg, formerly district manager of the New York office of the Westinghouse Electric & Manufacturing Company, has been appointed manager



W. S. Rugg

of the railway department, with headquarters at East Pittsburgh, succeeding Charles S. Cook. Mr. Rugg was born at Broadhead, Wis., and is a graduate of Cornell University. His connection with the Westinghouse company dates back to the early days when the company had its plant at Garrison Alley in Pittsburgh. He was later transferred to the Chicago office, and in 1901 was again transferred to the New York office as a special engineer. In 1909 he be-

came district manager of the New York office, which position he has held until this time. Mr. Rugg has been prominently identified with the work of the American Institute of Electrical Engineers, serving for a time as one of its managers.

Cyrus H. Loutrel, factory manager of the National Lock Washer Company, Newark, N. J., for the past six years, has been elected president of the company, to succeed the late William C. Dodd, who died suddenly March 12.

C. E. White has recently been appointed Chicago branch manager of the U. S. Light & Heat Corporation, Niagara Falls, N. Y. Mr. White has for several years past been manager of the Detroit Battery Company of Detroit.

H. A. Waldron, of the selling force of the H. W. Johns-Manville Company's general railroad department, at Chicago, has resigned to become sales manager of the New York office of the Stromberg Motor Devices Company.

Robert L. Arms, for several years connected with the sales department of Manning, Maxwell & Moore, has become associated with the Sherritt & Stoen Company, Inc., 603-604 Finance building, Philadelphia, as assistant to the general manager.

At a recent meeting of the stockholders of Harrison Brothers & Co., Inc., of Philadelphia, the stockholders agreed to accept an offer made by the Du Pont Company of Wilmington, Del., and the paint firm has become one of the Du Pont's subsidiaries.

Ernest H. Weigman, formerly general supervisor of master car builders' billing on the Atlantic Coast Line, with headquarters at Wilmington, N. C., has been appointed assistant secretary of the Master Car Builders' Association, with office in the Karpn building, Chicago.

L. E. Hassman has been appointed representative in

southern territory for Brown & Co., Inc., of Pittsburgh, Pa., with headquarters at New Orleans. Mr. Hassman since February, 1912, has represented the railroad department of the H. W. Johns-Manville Company in New Orleans.

The De Laval Steam Turbine Company, Trenton, New Jersey, announces the opening of a district sales office in the Smith Building at Seattle, Washington, in charge of William Pullen. In addition to steam turbines, the company's products include helical reduction gears as well as pumps and compressors of the centrifugal type.

J. L. Bacon has been appointed mechanical representative of the Economy Devices Corporation in charge of eastern territory, with headquarters in New York. For the previous five years Mr. Bacon was employed in the mechanical department of the New York Central, and leaves that company to take up his new duties.

Blake C. Hooper, district sales manager of the O'Malley-Bear Valve Company, Chicago, Ill., has resigned to become the head of a department, which the Paul J. Kalman Company, St. Paul, Minn., has created to represent the Oxweld Railroad Service Company, the Boss Nut Company and the National Car Equipment Company.

Chas. P. Williams, who has been appointed western representative at Chicago, for the railroad department of the West Disinfecting Company, graduated from the Minneapolis, Minn., high school in 1895 and immediately entered railway service with the Chicago, Milwaukee & St. Paul as an apprentice in the locomotive department at West Milwaukee, Wis. He entered the railway supply business as sales engineer and eastern agent of the Chicago Railway Equipment Company, with headquarters at New York City about eight years ago. He was special representative at Chicago for the National Lock Washer Company at the time his present appointment became effective.

Paul Judson Myler, whose election as president of the Canadian Westinghouse Company, Ltd., of Hamilton, Ontario, Canada, was announced last month, was born in Pittsburgh, April 24, 1869.



P. J. Myler

He was educated in the public schools of Pittsburgh, graduating from the Pittsburgh Central High School. He began his business career as bookkeeper in a Pittsburgh produce commission house. In 1886 he entered the employ of the Westinghouse Air Brake Company as bill clerk in its Allegheny shops, and advanced rapidly through the several bookkeeping and auditing positions of the company. In 1896 he was appointed secretary

of the Westinghouse Manufacturing Company, a corporation then being organized with a capital of \$500,000 to do a general manufacturing business in Canada, at Hamilton, Ontario. In 1897 he was made secretary-treasurer. In 1905 the company was reorganized as the Canadian Westinghouse Company, Ltd., capital \$5,000,000, to take over the Westinghouse Electric & Manufacturing Company's electric business and the air brake business of the Westinghouse Manufacturing Company. Mr. Myler was made vice-president and general manager in full charge of the Westinghouse interests in Canada. Mr. Myler is also a director in a number of other financial and manufacturing companies.

THE NATIONAL RAILWAY APPLIANCE COMPANY

In the March *Railway Mechanical Engineer* announcement was made of the incorporation of the National Railway Appliance Company for the purpose of selling railway supplies, and to take over the entire railroad department business of the United States Metal & Manufacturing Company of New York. The new company has temporary offices at 165 Broadway, New York City, but it will move about April 1 to new offices on the eighteenth floor of the building at 50 East Forty-second street, New York.

The company's officers are as follows: President, B. A. Hegeman, Jr.; first vice-president, Charles C. Castle; vice-president and treasurer, Harold A. Hegeman; assistant to president, F. C. Dunham; secretary and engineer, Edward D. Hillman. The company, as noted previously, has established a branch office in the McCormick building, Chicago, under the immediate management of Walter H. Evans, and a branch office in the Munsey building, Washington, D. C., under the management of J. Turner Martyn. Both managers were formerly connected with the railroad department of the United States Metal & Manufacturing Company.

Mr. B. A. Hegeman, Jr., president of the new company, was formerly in the railroad business. He started in 1878 with the Delaware, Lackawanna & Western, and was at one time general manager of the Lackawanna Live Stock Transportation Company. He left that position to go into the railway supply field as eastern sales agent of the American Car & Foundry Company, and in 1901 he was selected as the president of the United States Metal & Manufacturing Company, which position he has occupied for the past 16 years. Mr. Hegeman is also vice-president of the New York & North Shore Traction Company, vice-president of the Damascus

Brake Beam Company of Cleveland, and president of the Anglo-American Varnish Company of Newark, N. J. In 1914 he was president of the Railway Supply Manufacturers' Association.

Charles C. Castle, first vice-president of the company, has been in the supply business for a long time. He was for many years vice-president of the Hildreth Varnish Company, and became associated with the United States Metal & Manufacturing Company in 1910 as manager of the railroad department. He is vice-president of the Anglo-American Varnish Company of Newark, and secretary and treasurer of the Genesco

Corporation of Rochester, and was president of the American Electric Railway Manufacturers' Association in 1911.

Harold A. Hegeman, vice-president and treasurer of the company, has also been connected with the United States Metal & Manufacturing Company for the past nine years as salesman, and is well known throughout the New England territory and New York state among steam and electric railway officials.

F. C. Dunham, assistant to the president, has been with the United States Metal & Manufacturing Company for the past 13 years as special sales agent, and during that period he has made a wide acquaintance among railroad officials through the promotion of the sales of the Dunham hopper door device.

Edward D. Hillman, secretary and engineer, graduated from Lehigh University in 1898, with the degree of mechanical engineer. He was connected with several manufacturing concerns as engineer during the next four years, entering the employ of the New York Central in February, 1902. From 1902 to 1905 he was in the motive power and rolling stock department of the New York Central, going to the electrical department in December, 1905, where he remained until February, 1906, when he entered the employ of the United States Metal & Manufacturing Company as mechanical engineer.

Albert Clark Stebbins, a vice-president of the Niles-Bement-Pond Company, New York, died February 28 at his home in Plainfield, N. J., at the age of 73 years. He was born in Monson, Mass., and in the year 1865 he became an apprentice in the machine shop of Lucius W. Pond, Worcester, Mass. He remained with that company during its existence and with the organization of the Niles-Bement-Pond Company he was elected vice-president and manager of the Pond Works.



B. A. Hegeman, Jr.



F. C. Dunham



C. C. Castle



E. D. Hillman



H. A. Hegeman

J. Leonard Replogle, who, with his associates, recently purchased control of the Wharton Steel Company, has been elected chairman of the board. Other officials are: H. S. Endsley, president and treasurer; I. Townsend Burden, vice-president; Ernest Hillman, vice-president; H. C. Wenner, secretary, and F. B. Dutton, general superintendent.

HUNT-SPILLER MANUFACTURING CORPORATION

J. G. Platt, sales manager of the Hunt-Spiller Manufacturing Corporation, Boston, Mass., and Frank M. Weymouth, assistant to president, have been elected vice-presidents of the company.

Mr. Platt has been sales manager of the Hunt-Spiller Manufacturing Corporation, Boston, Mass., since June 1, 1912. He was born at Zanesville, Ohio, February 11, 1874. His parents moved to Baltimore in 1879, and he was educated in the public schools of that city. He entered railway service when he was not quite 15 years of age as a messenger for the Baltimore & Ohio. In January, 1890, he became an apprentice in the locomotive department of the same road, later entering the drafting room as a locomotive draftsman in 1894. On February 1, 1901, he was transferred to Newark, Ohio, as chief draftsman of the Lines West, but on December 20, 1902, he left the Baltimore & Ohio to accept the position of assistant to the master mechanic of the Erie at Jersey City, N. J. He was transferred to Meadville, Pa., April, 1903, as engineer of tests. On February 1, 1907, he left railway service and became master mechanic of the Franklin branch of the American Steel Foundries, with which company he remained until June 1 of the same year, when he accepted a position with the Hunt-Spiller Manufacturing Corporation as mechanical representative, later becoming sales manager, as noted above.



J. G. Platt

Mr. Weymouth was born in Boston, January, 1873, and was educated in the public schools of that city, after which time, until 1913, he held various positions in manufacturing industries. In February, 1913, he accepted the position of assistant to the president of the Hunt-Spiller Manufacturing Corporation, and will continue in that capacity, in addition to being vice-president.



F. M. Weymouth

E. D. Kilburn, manager of the power department of the New York office of the Westinghouse Electric & Manufacturing Company, has been appointed district manager of

this office, to succeed W. S. Rugg. Mr. Kilburn is a graduate of Cornell University. Immediately after leaving college he became identified with the Westinghouse Electric & Manufacturing Company at East Pittsburgh.

A. H. Ackerman, formerly vice-president and general manager of the United States Light & Heat Corporation, Niagara Falls, N. Y., and C. C. Bradford, formerly sales manager of the same company, announce the formation of the Bradford-Ackerman Corporation, with offices in the Forty-Second Street Building, New York, to represent various manufacturers of railway and electrical supplies for domestic and export trade.

The Dodge Manufacturing Company, Mishawaka, Ind., announces the acquisition of properties and products of the Oneida Steel Pulley Company and the Keystone Steel Pulley Company of Oneida, N. Y. The Dodge Steel Pulley Corporation was formed to control the two Oneida companies and will be a subsidiary of the Dodge Manufacturing Company. The sale and distribution of products of the corporation will be under the supervision of the Dodge Sales & Engineering Company, Mishawaka, Ind.

The Vanadium-Alloys Steel Company, of Pittsburgh and Latrobe, Pa., announces that arrangements have been completed whereby the following firms will represent the company in the sale of its high speed steel and its alloy and carbon tool steel: E. T. Ward's Sons, Boston, Mass.; George Nash Company, New York and Chicago; Field & Co., Inc., Philadelphia. A large stock of high speed steel in the most generally called for sizes will be carried at the various warehouses. These stocks are in addition to the stock carried by the Vanadium-Alloys Steel Company at its mill at Latrobe and its Pittsburgh warehouse.

The McGraw Publishing Company, Inc., and the Hill Publishing Company of New York have consolidated as the McGraw-Hill Publishing Company, Inc. The new company acquires all the properties and interests of the two constituents, including the Electrical World, Electrical Merchandising, Electrical Railway Journal, The Contractor, Metallurgical and Chemical Engineering, American Machinist, Power, Engineering News, Engineering Record, Engineering and Mining Journal, and Coal Age. The Engineering News and the Engineering Record will be consolidated as the Engineering News-Record, with Charles Whiting Baker as editor. The officers of the new company are: James H. McGraw, president; Arthur J. Baldwin, vice-president and treasurer; E. J. Mehren, vice-president and general manager. It is said that by the consolidation the new company will be the largest engineering publishing house in the world.

Frederick E. Reed, founder of two of the units of the present Reed-Prentice Company, Worcester, Mass., died at his home in Thompson, Conn., Feb. 18, after a short illness from paralytic shock. Mr. Reed, who was nearly 70 years old, had been active in machine-tool building from 17. He was first employed as a bookkeeper for the Wood & Light Machine Company, Worcester, in which his father, John Reed, had an interest. Later he became chief draftsman for the same company. In 1875 he bought the interest of Vernon Prentice in the firm of A. F. Prentice & Co., and in 1877 became sole owner of the business which, as the F. E. Reed Company, became one of the best known manufacturers of lathes. In after years he organized the Reed-Curtis Machine Screw Company and the Reed Foundry Company. He retired from active business in 1912, when all three of the enterprises in which he had been most prominent were absorbed into the Reed-Prentice Company. Mr. Reed was also heavily interested financially in other Worcester industries, notably the Mathews Manufacturing Company and the Worcester Lawn Mower Company.

CATALOGUES

VALVES.—The Mesta Machine Company, Pittsburgh, in Bulletin D describes and illustrates the Mesta automatic plate valves (Iversen patent).

POWER HAMMERS.—Beaudry & Co., Inc., Boston, Mass., have recently issued a 20-page booklet 6 in. by 9 in. in size, illustrating and describing the line of Beaudry hammers.

TUBE EXPANDERS.—Catalogue No. 11, recently issued by A. L. Henderer's Sons, Wilmington, Del., describes and illustrates that company's line of expanders, punches, pumps and jacks.

BELT FASTENERS.—The Crescent Belt Fastener Company, New York, describes and illustrates its devices in a pamphlet entitled "A Little Selling Talk." Crescent belt fasteners are adapted to use with all kinds of belting.

TAPS AND DIES.—Bulletin No. 1, recently issued by the Greenfield Tap & Die Corporation, Greenfield, Mass., is entitled "How to Measure Screw Threads," and describes the G T D thread limit gage, which the company is making for this purpose.

HIGH SPEED STEEL.—The Vanadium-Alloys Steel Company, Pittsburgh, has issued a folder descriptive of Vasco-Marvel, a semi-high speed steel. The folder contains much information of interest, together with the high speed steel standard classification of extras adopted July 22, 1915.

GUN-CRETE.—The Cement Gun Construction Company, Chicago, has issued a 16-page booklet, covering the composition of Gun-Crete, its application and the advantages of its use. The booklet is illustrated with photographs, showing its use in structures for rust and fire protection, in dams for waterproofing and in repairs to old and defective structures of all descriptions.

ROOF VENT AND LEADER CONNECTIONS.—The Barrett Company, New York, has issued a 20-page booklet describing the "Holt" roof connections. It contains descriptions of five types of roof connections, with illustrations and detailed drawings of each device. It also contains a drainage table, showing the size of leader outlets required for roof areas and for different slopes and roofing materials.

PORTABLE TOOLS.—H. B. Underwood & Co., Philadelphia, have recently issued a catalogue covering their extensive line of portable tools. The catalogue not only shows illustrations of new tools, but also covers many new and interesting features which have been added to the older types. The booklet contains much useful information, and is of especial interest at this time because of the rapid development which has recently taken place in the design of portable tools, and also because of their increased use in railway shops during the last few years.

CONDENSER CLEANERS.—Bulletin 0-2, recently issued by the Lagonda Manufacturing Company, Springfield, Ohio, contains complete descriptions of air, steam and electric driven cleaners for cleaning the small tubes of condensers, heaters, evaporators and similar apparatus. Graphic illustrations show the existing relationship between the vacuum and steam consumption. The bulletin is illustrated with views of Lagonda condenser cleaners at work in different types of condensers, in power plants and ice plants. A special cleaner for evaporator tubes is also described.

COCHRANE HEATERS.—The Harrison Safety Boiler Works, Philadelphia, has just issued catalogue No. 710, a 100-page booklet relating to the company's Cochrane heaters for steam

power plants. The book takes up open feed-water heaters for atmospheric service; heaters and receivers for use with exhaust steam heating systems; valve-stack heaters (combined heater, separator and valve); metering heaters for determining boiler capacity and efficiency, and heaters for use with water softeners. It is well illustrated with pictures showing the details of the heaters and the heaters in actual operation.

LONG LIFE FOR WOOD AT LOW COST.—The Barrett Company, New York, has recently issued a 14-page booklet with the sub-title "Where and How to Use Barrett Carbosota Grade 1, Liquid Creosote Oil." The booklet is illustrated with views, showing decay in various structures where untreated wood was used in contact with the ground or with concrete, brick or masonry. Two pages are devoted to a description and a detail plan of a simple and inexpensive wood treating plant, and several pages to the various uses and application of creosote oil, together with the directions for using.

GRINDING WHEELS.—The Star Corundum Wheel Company, Detroit, Mich., has issued Catalogue No. 9, describing the various types of grinding wheels made by that company and showing the various grinding machines for which they are adapted. The catalogue contains 98 pages, is well illustrated, and gives the list price of the various sizes and types of grinding wheels. It also contains information regarding vitrified, silicate and elastic grinding wheels, together with the uses to which these wheels should be put. Other information is given concerning the general safety requirements in handling grinding wheels, the proper grinding wheel speeds for the various sizes, the method of mounting and other information of interest to those handling grinding wheels.

WOOD BLOCKS.—The Barber Asphalt Company of Philadelphia recently issued an 18-page booklet describing its Non-X-Ude wood blocks, and illustrating their use in various kinds of service. Four pages are devoted to specifications covering the kind and grade of wood used, the size and treatment of blocks, the preservative used, the inspection at the works and the laying of the blocks. Several pages are devoted to telling why the blocks do not bleed, why they are durable and why they are used in various places. The booklet contains a table showing the weights of the different size blocks under treatment varying from 12 to 20 lbs. per cu. ft., and a comparative table compiled by the United States Forest Products Laboratory showing the average absorption of oil in lb. per cu. ft., the per cent of bleeding and the per cent of increase from swelling of blocks treated with water gas as compared with other treatments.

HIGH SPEED STEEL.—Catalogue No. 33, recently issued by the Midvale Steel Company, gives very complete information relative to the company's alloy and tool steel. The book is in five sections, dealing respectively with the following subjects: I. Midvale carbon tool steels, special alloy tool steels, high speed steels and Steelite. II. Midvale tool steel specialties, steels for hot work, miscellaneous steels, machinery steels, etc. III. Midvale alloy steels. IV. Forged shear blades, forged die blocks, steel rolls, etc., and forgings. V. Tables and useful information, and curves showing critical temperatures and physical properties. Under the various sections information is given as to the characteristics of the steel, its working, the grade numbers and uses of the various temper grades, the list of brands and the purposes for which each brand is best adapted, and the list of extras, etc. The booklet contains 144 pages, and has an 18-page index. The Midvale Steel Company has also recently issued a separate booklet giving information as to Midvale high speed tool steels. This booklet has 22 pages and a number of illustrations of machines on which high speed steel is being used.

Railway Mechanical Engineer

Volume 91

May, 1917

No. 5

Shop Equipment Number

The June number of the *Railway Mechanical Engineer*, while giving the usual attention to the various activities of the mechanical department, will be very considerably enlarged by the addition of a section relating especially to the more efficient and economical use of railway shop equipment and machinery. A number of special studies are being made and several special contributions have been arranged for covering various improvements which are being made not only in the installation of better equipment and machine tools but also in improved methods of shop operation. A special number of this sort is of particular value at this time, when the problem of maintaining power and rolling stock is acute. The railroads have just passed through a rather severe winter and equipment has been worked under especially heavy pressure and the prospects are that this will not be relieved for a considerable time to come. Usually at this time of the year a breathing space is experienced which allows the roads to get the equipment back into first-class shape, but there is very little possibility of this being experienced during the coming months and effective measures must be taken at once to remedy this condition and be prepared for the still heavier traffic which will undoubtedly tax the railroads to the very limit of their capacity next fall and winter.

The Grain Car Situation

Although a marked improvement in the car shortage situation has been brought about in the last few weeks, the conditions are still serious and it is almost certain that when the wheat crop begins to move, the western roads will find it very difficult to obtain cars suitable for loading with grain in sufficient numbers to supply the demand. The present high price of grain makes it more important than ever to keep the loss in transit down to the minimum. Last year much difficulty was experienced in getting a supply of cooping materials. The present indications point to similar conditions this year, so it will be necessary to have cars in condition to carry grain without much special preparation if the situation is to be met satisfactorily. Although car builders have been working their plants at full capacity, the number of cars built for export has been very high, and for that reason the number of new cars available this year will not be much greater than in previous years. Aside from this, there is such a great demand for cars that they are not apt to be sent to the repair track until their condition is such that they are hardly fit for lading of any sort, and a smaller percentage of the total number of cars will be found suitable for grain. The combination of conditions which has been mentioned will undoubtedly make the grain car situation unusually serious this year. The railroads should realize the facts and in order that they may be prepared for the great demand for cars, which is to be expected when the crops start to move, they should begin at once to put as many cars as possible in condition to carry grain.

Mechanical Conventions Postponed

The Master Mechanics' and Master Car Builders' Associations, following the example of the American Railway Association, have postponed their annual conventions indefinitely. The Air Brake Association had gone so far with its plans that it was not advisable to call off the meeting which is being held this week at Memphis. Undoubtedly all of the other mechanical associations will follow the examples of the two large associations. The railways have a tremendous problem before them in taking care of the traffic which must be handled in the coming months. Nothing must be allowed to interfere with their effectiveness during this period of national crisis. While facilities of various kinds are greatly needed, it will be practically impossible to do very much in supplying them because of the scarcity of material and high prices; labor is also scarce. Wonderful results may be accomplished, however, if all the men serving in various capacities in railroad service will put forth their very best energies and give freely of their time and strength in serving the nation through a more economical and efficient operation of the railways. Experience during the past two years and a half of war in Europe has demonstrated that the transportation system forms the very backbone of the army, whether it is near the front in handling the fighting units, munition and supplies, or whether it is far away from the scene of conflict, gathering together and distributing the various supplies upon which the nations depend for their existence. Let every man in the mechanical department give of the very best that is in him.

The Railroads and the War

As a nation, we have entered upon a great enterprise. We have joined in the most gigantic struggle in the history of civilization to defend a great ideal—the ideal of human liberty. In many respects this will be the severest test to which we have ever been put as a nation. On our conduct in this struggle may depend our right to be considered the chief exponent of freedom and democracy. In this crisis every loyal American citizen has a duty to perform.

The importance of everyday activities as a factor in the conduct of war is evident today as never before. Armies and navies are but the two clenched fists of which nations themselves are the bodies. Unless the body is healthy and normal in all its functions, the striking power of the fists will soon be impaired. That the railroads play a vital part in the normal activities of the nation hardly need be called to the attention of railroad men. Events of the past few months have brought this fact into strong relief. Apparently taxed to the utmost for months past and operating under handicaps, for many of which they cannot be held responsible, they will be called to redoubled effort to play their part in the co-ordination and concentration of the nation's resources upon the prosecution of the war. To the

officers and men of the mechanical department falls the task of keeping cars and locomotives in serviceable condition to move an extraordinary volume of traffic and to do this with facilities already heavily taxed.

A national crisis such as we have entered upon always causes considerable excitement and some hysteria. No doubt, the duty of some men from every industry will lead to the firing line. That those who remain may be prepared to meet the extraordinary demands which will be placed upon them, the utmost calmness is essential. The everyday tasks of the machine shop, the boiler shop, the erecting shop and the car shop must be faithfully performed and every move must be made to count. No more patriotic duty can be performed by the men, the foremen and the officers of the mechanical department than to see that every locomotive and every car is in shape to meet the demand to come. This is essential if the railroads are not to fail in the performance of the great task before them. They must not fail!

Locomotive Brick Arch Tests

While there have been reports of road tests showing various degrees of economy derived by the use of a brick arch in the firebox of a locomotive, there never have been made what might be called scientific tests until those which were made by the Pennsylvania Railroad on its testing plant at Altoona. These tests, which are described elsewhere in this issue, were made under like conditions and show definitely the advantage a locomotive has with a brick arch over the same locomotive with no arch, operating under like conditions. The results of these tests, which are distinctly favorable to the arch, would have been still more favorable had the arch tubes in the firebox been removed with the fire brick when the "no arch" tests were made. It is well known that arch tubes play an important part in the economy of the arch. For this reason, therefore, the results shown by the tests may well be considered conservative. There were three important points disclosed by these tests. First, the value of the arch as a fuel saver; second, the increase in boiler capacity made possible by the arch, and third, that even with more complete combustion the superheat temperature of the steam was not materially increased.

These tests show that more steam will be generated than when no arch is used. The long flameaway the gases are made to travel and the mass of heated brick which aids the combustion of the gases are responsible for this. While this does not mean more power in the cylinder, it does mean that the cylinders have a greater supply of steam from which to draw. This greater supply, or increase in boiler capacity, may be used in either of two ways. The cylinders may be enlarged and the power of the locomotive thus increased, or the additional supply of steam may be used in hauling trains of the same weight at faster speeds than if no arch were used.

The tests showed that the drawbar pull was greater at speeds above eight miles an hour when the locomotive was equipped with an arch, than when the arch bricks were removed. At 29 miles an hour this increase in drawbar pull was 6.4 per cent. Perhaps the most instructive diagram shown in connection with the article on these tests is Fig. 5 which gives the relation between the amount of coal fired and the horsepower at the drawbar of the locomotive. This chart shows that with 4,000 lb. of coal fired per hour, the drawbar horsepower for the locomotive equipped with the arch was 16.7 per cent greater than when the locomotive had no arch. At the higher rates of combustion, this percentage increase was not so great. When 7,000 lb. of coal was fired per hour, the increase was 11.5 per cent. This shows clearly what the arch means to the locomotive and should indicate to those roads seeking to increase their

locomotive capacity; an avenue that can be easily followed. To those roads which have a large number of brick arches in service, these tests should indicate the importance of keeping the arches in first-class operative condition.

Routing Work In Railroad Shops

To secure the maximum output in a shop and to facilitate the work of supervision it is essential that there be a definite method of handling all routine work. The problem of grouping tools to secure a satisfactory routing of parts is a difficult one in a railroad shop and the output is often materially reduced by faulty arrangement.

In handling a diversified line of work, as most railroad shops did 15 or 20 years ago, when they made a large number of parts for all departments of the road, it might be advisable to group machines by classes, placing lathes in one section, planers in another, milling machines in a third, and so on. There are still a great many special jobs which must be taken care of in railroad shops, but the principal work is repairing and replacing worn parts of locomotives or cars, and for such work the location of machines should be determined by the path which it is intended to have the parts follow from the time when they are removed until they are replaced on the equipment. In a locomotive shop tools should be arranged so that wheels, driving boxes, shoes and wedges, pistons, crossheads and the other parts to be worked on can be kept moving, as far as possible, in a direct line from the point where the locomotive is stripped to the point where it is again assembled.

The arrangement of too many shops has been made on a hit-or-miss plan, similar machines being grouped in one section without regard for the movements necessary in performing the operations on the parts which the machines handle. In all large shops one planer or shaper is kept busy practically all the time finishing shoes and wedges after they have been laid off, yet how many shops have a machine located convenient to the erecting pits for that purpose?

The illogical and uneconomical location of machine tools is to be found in some shops which have been built quite recently, but for the most part it is due to the attempt to rebuild or rearrange old shops to meet present demands. Some of the costliest errors in shop layouts are the results of attempts to make extensive additions to existing shops, still retaining the old machines in their original locations. In adding machine tools the prime consideration usually is to determine where the machine can be placed with the least trouble and expense. The cost of the extra handling which this method of location makes necessary may be small for the individual parts, but repeated over and over the amount grows to such proportions that it is almost always cheaper to put the machine where it belongs in the first place, even though it necessitates considerable expense and trouble.

In one locomotive shop where it had been the practice to finish the shoe and wedge fit on driving boxes on a planer, this work was transferred to a horizontal spindle milling machine. This finished both faces with one setting, and reduced the cost of the operation materially. Shortly after the change was made the shop was called upon to deliver a much greater output. The machine tool equipment was sufficient to take care of the demand, but the crane service became overtaxed. The milling machine was some distance from the planer and boring mill on which the other operations on the boxes were performed and great difficulty was experienced in getting driving boxes finished when they were needed. The milling machine was finally moved next to the boring mill, although this necessitated the relocation of three large machines. The congestion was at once relieved, and the desired shop output was secured without difficulty. This is an extreme case, of course, but many shops are suffering, in a minor degree, from poor machine tool grouping.

A logical arrangement of machine tools alone will not ensure efficient and economical operation, but it is an important factor in attaining that end and deserves much study when changes or additions are to be made.

The Railway Equipment Situation

The railways of the United States and Canada in the first four months of 1917 placed orders for 1,288 locomotives and 29,592 freight cars as compared with 1,315 locomotives and 45,397 freight cars in the first four months of 1916. During the same four months of 1917 orders have been received from overseas for 454 locomotives and 14,550 freight cars as compared with 604 locomotives and 15,275 freight cars in the same period of 1916. It is a source of gratification that even with the great uncertainty that has characterized the past few months the purchases of equipment have kept up so well to last year's exceptionally good records.

But it is a fact that the purchasing of cars and locomotives is being retarded by the uncertainty of the present situation. The railways, however, still need cars and locomotives as much as ever. The aggregate shortage of freight cars on the railroads of the United States on April 1 as reported to the American Railway Association was 145,059. This was an increase of 12,977 over the shortage on March 1 and was not only the largest reported since the present freight congestion and shortage began last September but the largest shortage ever reported by the railroads. The American Railway Association points out that some of this shortage may represent duplications, for shippers frequently file identical orders for cars with all railroads that can take their shipments. But there is no reason to believe that there will be much improvement in the near future. The United States, having now joined the Allies, will become more than ever their base of supplies, and that can only mean that the railways will be called upon to carry greater shipments to the seaports. What demands there will be made upon the railways for troop movements does not yet appear, but if such demand should be made within the next six months or a year it will tie up cars and motive power worse than ever.

The railway mechanical departments are not in a particularly enviable position under these circumstances and there is not much reason to believe that there will be improvement until after the close of the war. For one thing, they are short of labor now and will have more and more difficulty in securing labor as the new American armies are gathered together. There will be increasing demands for repairs on cars and locomotives, and there is not much chance under present conditions that there will be new equipment to be looked forward to. The railways are feeling the uncertainty of financing, and, no doubt, the demands of the government for steel and similar materials will hinder the ready building of equipment. There is no doubt, either, that the allied countries will discontinue their foreign buying. There has been a lull for some time to be sure, but now comes the cable report that the Russian Government may buy 2,000 locomotives and 40,000 cars in America, and the more substantial information that the Baldwin Locomotive Works has recently received orders for 113 more Russian engines. The car and locomotive plants may also be called upon for the manufacture of munitions. They are already being called upon to build armored cars and may even be given orders for narrow gage cars and engines for American armies in the field. These things will certainly delay deliveries and they won't reduce prices.

The mechanical officers, however, need not look forward with feelings of fear and trepidation. They are going to be able to play a big part in helping America in this war. They are and should be already setting their house in order for the big things to come. Every car and locomotive should

be put in the top notch of efficiency or in as good condition as the present conditions will allow, for the chances of making up deferred maintenance are daily going to become less and less. The demands upon railway shops are going to increase immeasurably. If the car and locomotive plants are to be handicapped the railway shops may have to build cars and locomotives themselves; many roads have already placed large orders for cars with their own shops. They will also be called upon to convert equipment to military uses. We may soon see them using some of that ingenuity for which the American railway man is famed in converting passenger equipment to ambulance trains, to commissary cars and what not.

Readjustment To Present Conditions

The mechanical departments of the railroads are now facing tremendous problems in bringing about the readjustment of their work which the recent unusual advances in the cost of labor and materials have made necessary. During the past three years the roads have experienced unprecedented increases in the cost of nearly all of the supplies they use. Furthermore, there have already been large increases in the wages of shopmen during the same time and, stimulated by the passage of the Adamson act, many of the employees are now demanding even more. It is inevitable that the cost of maintenance of equipment should rise very materially under such conditions, but a careful study should be made at this time in order to make the increase as small as possible.

At the time when the large increases in the cost of materials began, railroad mechanical men started to take energetic measures to offset them as far as possible by economy in the use of supplies. The advance in wages resulted in attempts to secure greater efficiency in the shops and the recent rise in the price of coal is now calling forth increased efforts for fuel economy. The indications are that the present high prices of materials and the present high wages will continue for a considerable length of time. While up to this time much has been done to combat the individual increases, the railroads should now look at the changes as they affect the cost of transportation in order to take the most effective steps to reduce not the individual items of expenditures, but the cost of operation as a whole.

To save wages and materials wherever possible it is especially important under the present conditions that the railroads provide sufficient equipment in shops and engine houses. The increased cost of wages justifies greater expenditures for new and improved tools, for special fixtures and for the redesigning of shops and terminals with a view to saving labor. The best of facilities for reclaiming parts should also be furnished in order that the expenditures for new material may be kept at the lowest possible figure. In spite of the high cost of shop equipment and of construction at the present time, the possibilities of savings along these lines should be carefully considered.

Attention has already been called to the necessity for the mechanical department to use every measure in its power to reduce fuel consumption, and it is not necessary to point out the various ways in which this can be accomplished. It may be that if the present high prices of fuel continue for a considerable number of years it will result in the extensive adoption of compounding combined with superheating. At the present price of coal the saving in fuel would probably offset the higher cost of repairs of the compound locomotive.

The Adamson law necessarily imposes a great burden on the railroads. To keep down as much as possible the amount of the increase in wages which the new schedule will cause it is necessary to have locomotives of high capacity. It is not enough that the locomotive be able to drag a train over the division without delays. It must have sufficient power to bring the train up to a considerable rate of speed if it is

to be an economical unit in the transportation system. Furthermore, the power must be kept in the best of condition to prevent delays which will be more expensive than ever.

Car department officers should appreciate the increased importance at this time of reducing the weight of cars wherever it can be done without an important sacrifice of strength. The cost of hauling dead weight is no inconsiderable item and a marked decrease in expenses can be made by judicious reduction in the weight of the cars. The possibility of saving empty haul by the use of cars adapted to various classes of lading should not be overlooked.

Last and most important of all, the mechanical department officers should co-operate with the officers of other departments of the railroad organization to solve the big problems now confronting them in a broad and thorough way and to take such measures as will secure the highest over-all efficiency from the railroad system.

NEW BOOKS

Proceedings of the Traveling Engineers' Association. Illustrated, 390 pages, 6 in. by 8½ in., bound in leather. Published by the association, W. O. Thompson, secretary, New York Central Lines, Cleveland, Ohio.

The Proceedings of the Traveling Engineers' Convention, which was held in the Hotel Sherman, Chicago, October 24, 25, 26 and 27, 1916, contains papers and discussions on the following subjects: The Effect of Mechanical Placing of Fuel in Locomotive Fireboxes on the Cost of Operation; Advantages of Superheaters, Brick Arches and Other Modern Appliances on Large Locomotives; Difficulties Accompanying the Elimination of Dense Black Smoke; Recommended Practice in the Make-Up and Handling of Modern Freight Trains on both Level and Steep Grades to Prevent Damage to Draft Gear; Assignment of Power from the Standpoint of Efficient Service and Economy in Fuel and Maintenance, and How Best to Educate the Road Foreman, the Engineer and the Fireman.

In connection with the remarks on firing with powdered coal, printed on page 78 of the proceedings, considerable was said in exploitation of the Powdered Coal Engineering & Equipment Company's "carburization" process. While the burning of powdered coal is feasible and has been in successful use for a number of years in metallurgical furnaces, the apparatus of this particular company is still in the experimental stage and its commercial value has yet to be determined. It is unfortunate, therefore, that the association should give its official approval by publication in its proceedings to this product, the merit of which is still undetermined. In this particular case there is further cause for regret because of the method which this company is using in exploiting its products. From its circulars and advertising matter it appears to be more interested in influencing people to buy its stock by means of extravagant theoretical claims for its product, than in developing and selling its fuel burning system.

Oxyacetylene Welding and Cutting. By P. F. Willis. Bound in cloth; 180 pages; 4 in. by 6 in. Illustrated. Published by P. F. Willis, 2305 North Eleventh street, St. Louis, Mo. Price 50 cents.

In the introduction to this book the author states that his purpose in publishing it was to smooth the way for those who are starting to use the oxyacetylene process of welding and cutting. It is quite frankly the expression of the author's views on the subject, together with general information pertaining to the materials used and their production. The chapters are devoted to torches, the apparatus and its installation, preparing for welding, the welding of different metals and the welding of parts which require special treatment. While written from the standpoint of the general welding shop operator, railroad shop men who are using the oxyacetylene process will find in it much information of value to them.

COMMUNICATIONS

WHAT IS AN ENGINE FAILURE?

CHICAGO, Ill.

TO THE EDITOR:

In reply to the inquiry of "W. J." of Boston, published in the March issue, asking what an engine failure is, I quote below the instructions governing engine failures on one of the Western railroads:

DELAYS THAT ARE ENGINE FAILURES

Delays caused at initial terminals by waiting for locomotives, shall be considered an engine failure, except where an engine which must be turned does not arrive at the round-house in time to be despatched and properly cared for before leaving time.

Delays at a terminal, at a meeting point, at a junction, or delays which are responsible for delays to other traffic, caused by the locomotive breaking down, running hot, not steaming well, or by having to reduce the tonnage as a result of defects in the locomotive, shall be considered engine failures.

DELAYS THAT ARE NOT ENGINE FAILURES

If a locomotive loses time and afterwards makes it up without delaying other traffic, or being late at connecting points, no failure shall be charged.

If a passenger or scheduled freight is delayed by an engine failure and other causes, the failure shall not be considered if the locomotive makes up more time than it lost on its own account.

An engine shall not be charged with a failure if it is given excess tonnage and stalls on a hill, providing it is working and steaming well.

Delays to scheduled freight trains which make them less than 20 min. late at terminals or junction points shall not be considered failures.

Delays on extra dead freight trains shall not be considered if the run is made at an average speed of greater than 10 miles per hour.

A locomotive shall not be charged with a failure if it is delayed on account of its steaming badly or on account of leaking tubes where the locomotive has been held on side tracks for other reasons than its own defects, or where the engine has been on the road for an unreasonable length of time such as 15 hours for a run of 100 miles.

Reasonable delays caused by cleaning fires and ash pans on the road shall not be considered as failures.

A failure on a locomotive coming from an outside point to the shop for repairs shall not be considered.

Where the transportation department is informed that a locomotive will not be ready until a stated time on account of needed repairs, failure to provide that engine before the time at which it was promised, that time shall not be considered an engine failure.

If the draft rigging on locomotives or tenders is broken on account of a sudden application of the air brakes caused by a bursting hose among the cars, or a break-in-two the accident shall not be counted as a failure.

Where a locomotive is working and steaming well, no failure shall be charged to it when it is handling fast scheduled trains under weather conditions which make it impossible to run on time.

Delays caused by locomotives running out of coal and water on account of being held between coal and water stations an unreasonable length of time, shall not be considered an engine failure.

A. B. C.

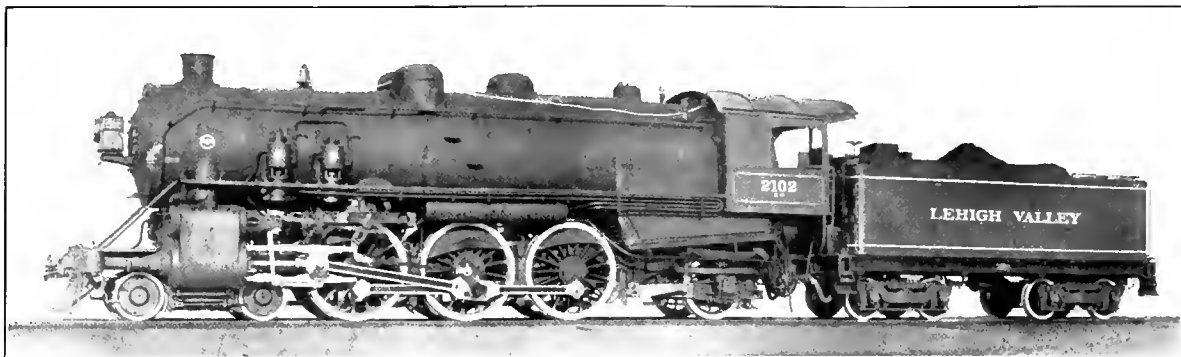

NEW POWER FOR THE LEHIGH VALLEY

Pacific Type and 2-10-2 Type Locomotives of Large Tractive Effort for Fast and Slow Freight Service

THE Lehigh Valley has reduced its train-miles in freight service on the Wyoming and Seneca divisions by the addition of 30 Powerful Pacific type locomotives and forty 2-10-2 type locomotives, built by the Baldwin Locomotive Works.

The Pacific type locomotives are used in fast freight service between Manchester, N. Y., and Coxton, Pa., which is near Pittston, a distance of 175 miles. They haul 50 loaded cars, both eastbound and westbound, and make the run in 5½ hours. By the use of these locomotives two fast freight trains which were previously hauled by heavy 10-wheel locomotives having a tractive effort of 31,000 lb., have been consolidated. From Coxton to Summit, N. Y., about 120 miles, there is a

respect to the latest design of the Lehigh Valley Mikado locomotives, 20 of which were built in 1916.

The 2-10-2 type locomotives are used in slow freight service between Manchester, N. Y., and Sayre, Pa., a distance of 88 miles, with 0.4 per cent grades. These locomotives exert a tractive effort of 72,800 lb. and will haul 4,000 tons, making this run in 6½ hours. They burn a mixture of fine anthracite and soft coal. Each locomotive replaces two heavy Consolidation locomotives, having a tractive effort of 36,000 lb. each.

The boilers of the Mikado, Pacific and 2-10-2 types are all of the same diameter at the front end and have the same number and diameter of tubes. The Mikado and the Pacific

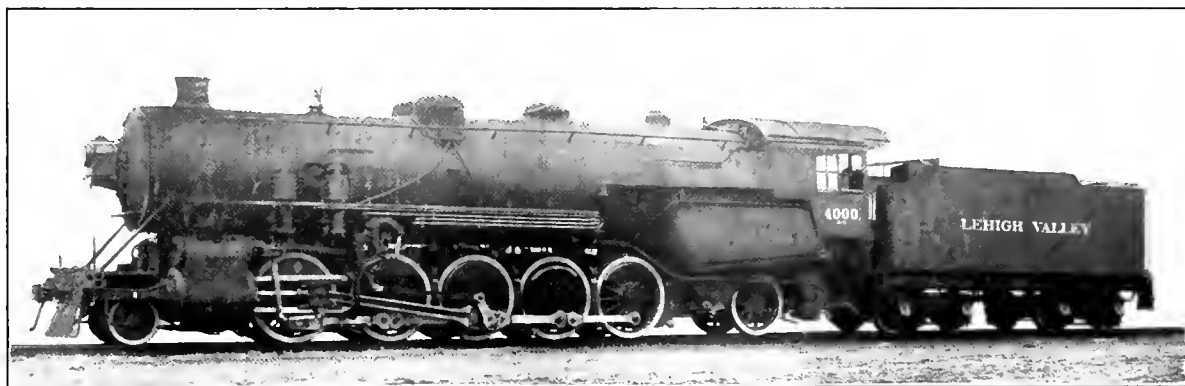

Santa Fe Type Locomotive for the Lehigh Valley

steady up-grade with many curves, the gradient running as high as 0.4 per cent. From Summit there is a down-grade to within seven miles of Manchester, where there is a steady rise with a 0.4 per cent grade 4.26 miles long. The Pacific type locomotives are also used for heavy express passenger traffic on the Wyoming division which extends between Pittston and Athens, Pa., with a maximum grade of 0.2 per cent. These locomotives are among the most powerful of their type, exerting a tractive effort of 48,700 lb., or 55 per cent greater than the tractive effort of the 10-wheel locomotives which they replace. They are designed for burning bituminous coal and differ in this respect from the greater part of the motive power on the Lehigh Valley. They resemble in many

type locomotives have tubes 17 ft. 6 in. long, while the 2-10-2 type engines have tubes 21 ft. long. The fireboxes of the Mikado and Pacific type locomotives are different, in that the Mikado locomotives use a mixture of anthracite and soft coal and have 100 sq. ft. of grate area, as compared with 75 sq. ft. grate area for the Pacifics, which use soft coal. Both the 2-10-2 and the Pacific type locomotives have combustion chambers. That in the 2-10-2 is 60 in. long and that in the Pacific type is 48 in. long.

The boilers for both the Pacific and the 2-10-2 type locomotives have a conical ring in the middle course, which increases the outside diameter from 83¾ in. to 94⅞ in. The seam of the smokebox ring is welded along the top center line

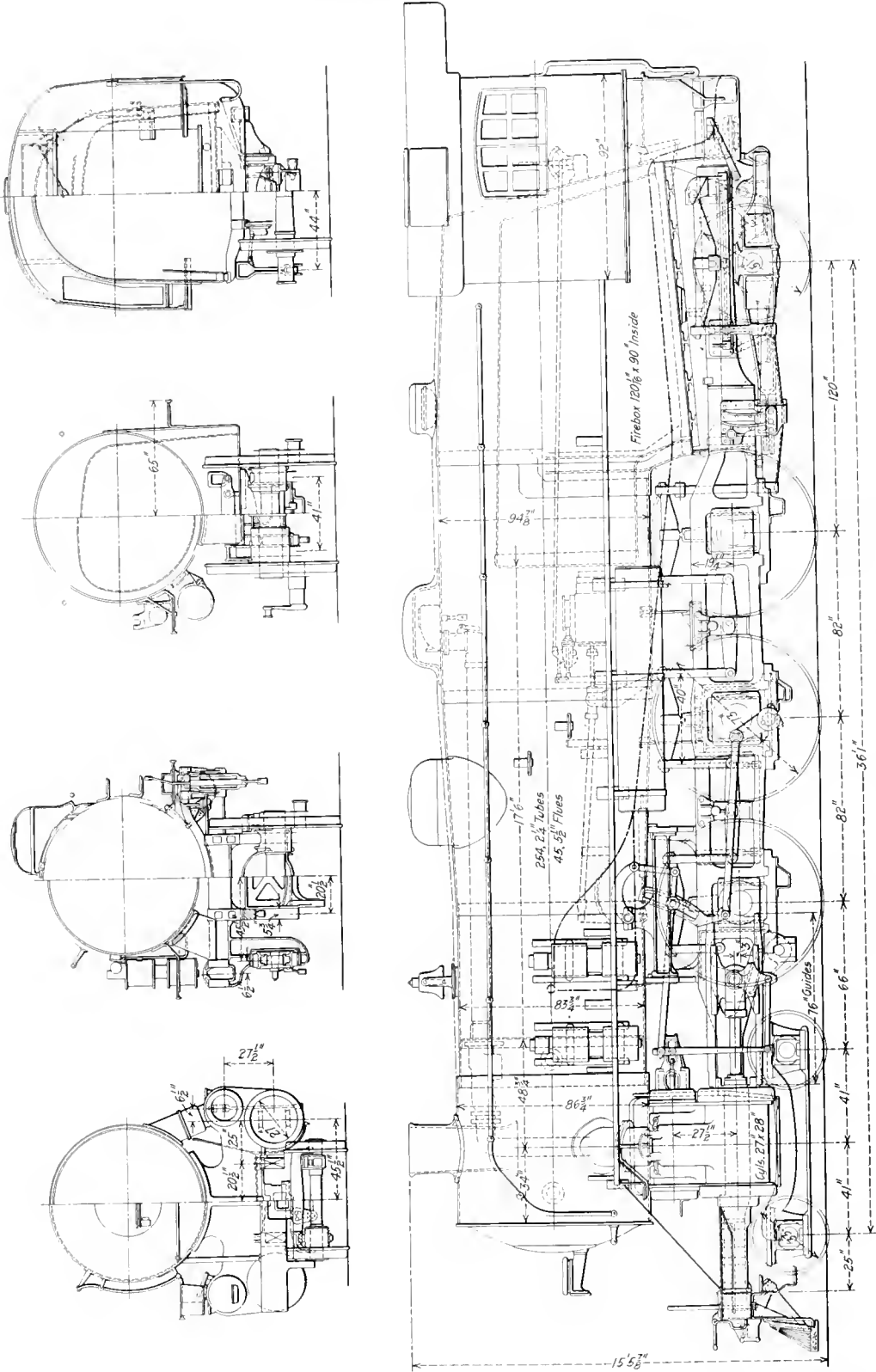

Elevation and Sections of Pacific Type Locomotive for the Lehigh Valley

cross sectional area, free from abrupt bends. The steam chests are fitted with vacuum relief valves. When drifting, saturated steam may be admitted to the cylinders through a small pipe which leads from a shut-off valve tapped into the steam turret. This pipe is provided with a line valve conveniently placed in the cab.

The Walschaert valve gear is used on 20 of the Pacific locomotives and the Baker valve gear is used on the remain-

Baldwin Mikado type locomotives built for the Lehigh Valley. The reciprocating parts are similar in design to those of the Pacific type locomotives. The following is a list of the general dimensions and ratios for both types of locomotives:

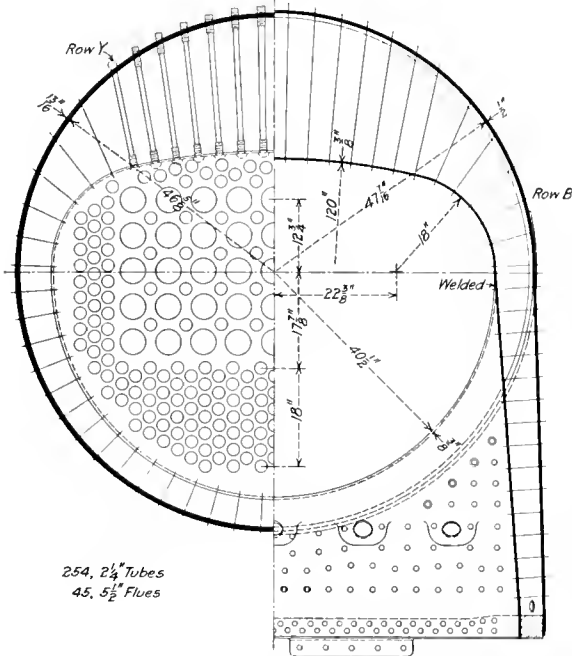

Section Through the Firebox of the Pacific Type Locomotive

ing ten. The Ragonnet power reverse mechanism is applied. The valves are set with a travel of 6 in. and a lead of 5/16 in. The steam lap is 1 3/16 in., and the exhaust clearance is 1/8 in. Thirty of the 2-10-2 locomotives are fitted with the Walschaert valve gear, while the remaining ten have the Baker valve gear. The piston valves interchange with those

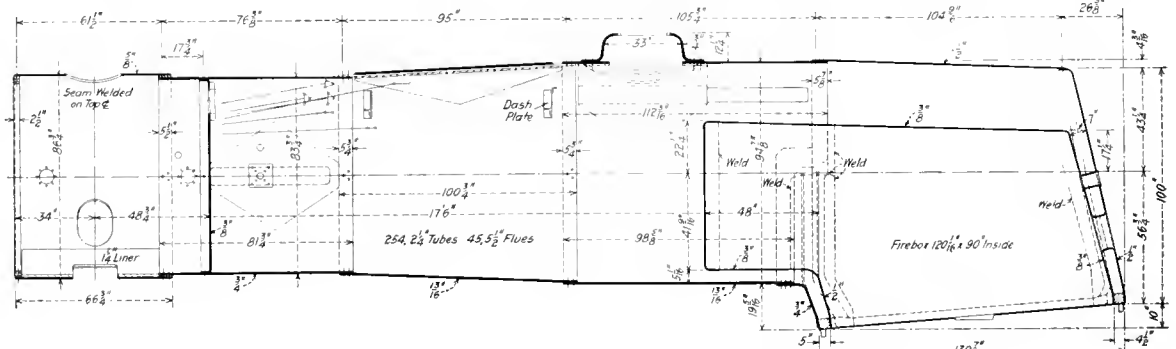

Boiler for Lehigh Valley Pacific Type Locomotives

of the Pacific type locomotives, and the valve setting is the same, except that in the 2-10-2 locomotives the exhaust clearance is reduced from 1/8 in. to 1/32 in.

The Economy front truck is used in the 2-10-2 design, in combination with the Economy lateral motion front driving-box. The rear truck is of the Rushton type, with inside journals. This design of truck has been applied to all the

General Data

Type	4-6-2	2-10-2
Service	Fast freight and heavy passenger	Freight
Fuel	Soft coal	Hard and soft coal mixed
Tractive effort	48,700 lb.	72,800 lb.
Weight in working order	301,500 lb.	370,000 lb.
Weight on drivers	197,200 lb.	289,000 lb.
Weight on leading truck	51,000 lb.	29,000 lb.
Weight on trailing truck	53,300 lb.	52,000 lb.
Weight of engine and tender in working order	458,700 lb.	540,000 lb.
Wheel base, driving	13 ft. 8 in.	22 ft. 6 in.
Wheel base, total	36 ft. 1 in.	41 ft. 8 in.
Wheel base, engine and tender	68 ft. 10 3/8 in.	74 ft. 6 in.

Ratios

Weight on drivers ÷ tractive effort	3.9	4.0
Total weight ÷ tractive effort	6.2	5.1
Tractive effort × diam. drivers ÷ equivalent heating surface*	639.2	685.0
Equivalent heating surface* ÷ grate area	74.3	66.9
Firebox heating surface ÷ equivalent heating surface*, per cent.	6.6	6.6
Weight on drivers ÷ equivalent heating surface*	34.5	43.2
Total weight ÷ equivalent heating surface*	54.1	55.3
Volume both cylinders	18.6 cu. ft.	4.5 cu. ft.
Equivalent heating surface* ÷ vol. cylinders	300.6	273.
Grate area ÷ vol. cylinders	4.0	4.1

Cylinders

Diameter and stroke	27 in. by 28 in.	29 in. by 32 in.
---------------------	------------------	------------------

Valves

Kind	Piston	Piston
Diameter	14 in.	14 in.
Greatest travel	6 in.	6 in.

Wheels

Driving, diameter over tires	73 in.	63 in.
Driving, thickness of tires	3 1/2 in.	3 1/2 in.
Driving journals, main diameter and length	13 in. by 20 in.	13 in. by 20 in.
Driving journals, front, diameter and length	11 in. by 14 in.	11 in. by 14 in.
Engine truck wheels, diameter	7 in. by 12 in.	7 in. by 12 in.
Trailing truck wheels, diameter	51 in.	51 in.
Trailing truck, journals	9 in. by 14 in.	9 in. by 14 in.

Boiler

Style	Conical	Wagon-top
Working pressure	205 lb. per sq. in.	200 lb.
Outside diameter of first ring	83 3/4 in.	83 3/4 in.
Firebox, length and width (ins.)	120 1/2 by 90	126 1/2 by 114 1/4
Tubes, number and outside diameter	254, 2 1/4 in.	254, 2 1/4 in.
Flues, number and outside diameter	45, 5 1/2 in.	45, 5 1/2 in.
Tubes and flues, length	17 ft. 6 in.	21 ft.
Heating surface, tubes and flues	3,734 sq. ft.	4,485 sq. ft.
Heating surface, firebox	369 sq. ft.	438 sq. ft.
Heating surface, total	4,103 sq. ft.	4,923 sq. ft.
Superheater heating surface	980 sq. ft.	1,179 sq. ft.

Equivalent heating surface*	5,573 sq. ft.	6,691.5 sq. ft.
Grate area	75 sq. ft.	100 sq. ft.

Tender

Weight	157,200 lb.	170,000 lb.
Wheels, diameter	36 in.	36 in.
Journals, diameter and length	5 1/2 in. by 10 in.	6 in. by 11 in.
Water capacity	8,000 gal.	9,000 gal.
Coal capacity	12 1/2 tons	15 tons

* Equivalent heating surface = total evaporative heating surface + 1.5 times the superheating surface.

LOCOMOTIVE BRICK ARCH TESTS

Comparative Test Plant Results Show That Brick Arches Increase Drawbar Horsepower From 12 to 16 Per Cent

THE importance of the brick arch to locomotive operation was never made more apparent than by the extensive tests recently conducted on the locomotive test plant of the Pennsylvania Railroad, the results of which are published in its Bulletin No. 30.* While numerous road tests have been made on different railroads showing a saving of fuel, an increase in boiler capacity and a reduction in smoke by the use of the brick arch, there has nowhere been available as complete and definite information regarding the advantages of the brick arch on modern locomotives as contained in this bulletin.

The tests were made on a Mikado locomotive (Class L1s) of the following general dimensions:

Weight in working order.....	320,700 lb.
Weight on drivers.....	240,200 lb.
Cylinders (diameter and stroke).....	27 in. by 30 in.
Driving wheel diameter.....	62 in.
Heating surface, tubes (water side).....	3,713.8 sq. ft.
Heating surface, tubes (fire side).....	3,372.0 sq. ft.
Heating surface, firebox (fire side).....	305.97 sq. ft.
Heating surface, superheater (fire side).....	1,233.24 sq. ft.

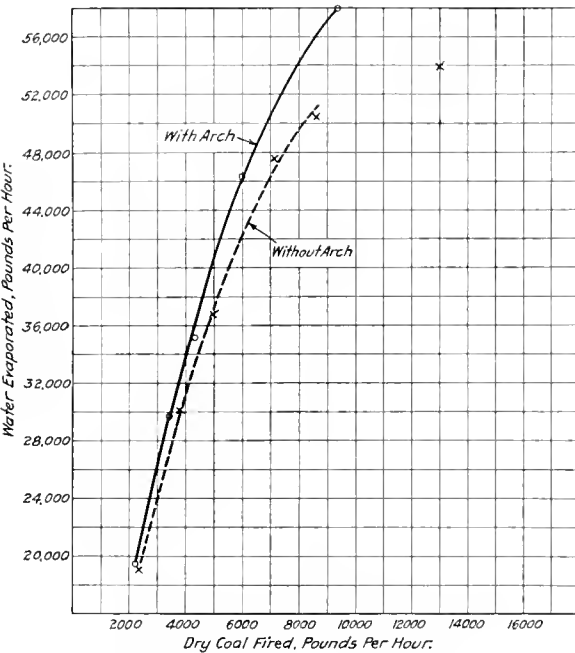

Fig. 1—Coal Fired and Water Evaporated

Heating surface, total (fire side).....	4,911.21 sq. ft.
Grate area.....	70.37 sq. ft.
Boiler pressure.....	205 lb.
Small tubes, number and diameter.....	236—2 1/2 in.
Large tubes, number and diameter.....	40—5 1/2 in.
Tube length.....	18 ft. 11 in.

Ratios

Total heating surface ÷ grate area.....	69.00
Fire area through tubes ÷ grate area.....	0.12
Firebox heating surface ÷ grate area.....	4.35
Tube heating surface ÷ firebox heating surface.....	11.02

Five tests were made with a Security sectional brick arch in the firebox and six were made with the arch brick removed to show the evaporative range of the locomotive in both cases. Of the five arch tests, two were made at a speed of 14.5 m. p. h., one with a 30 per cent cut-off and the other with a 50 per cent cut-off; two were made at 21.7 m.p.h., one

with a 50 per cent cut-off and the other with a 60 per cent cut-off, and one was made at 28.9 m.p.h. with a 65 per cent cut-off. In the tests without the arch the same program was followed with the addition of a test at 28.9 m.p.h. with a 60 per cent cut-off.

The brick arch was supported on four water tubes, 3 in. in diameter. It extended 6 ft. 4 in. from the tube sheet, or to a point 4 ft. 4 3/4 in. from the rear water leg of the firebox. The minimum distance between the crown sheet and the top of the arch was 20 3/4 in.

While the tests were made to determine the effect of the brick arch on the boiler, the engine and the locomotive itself, no consideration was given the arch tubes, which were left in the firebox for both sets of tests. This must be kept in mind throughout the following discussion as it has been demonstrated that the arch tubes play no small part in the increase in efficiency attributed to the brick arch. Other experimenters have found that the arch tubes alone by their added heating surface and the increased circulation of the water are responsible for a saving in the boiler efficiency of approximately one per cent per tube. The advantages shown for the brick arch in these tests would undoubtedly have been greater had the arch tubes been removed with the bricks in the "no arch" tests.

All of the tests were fired by hand with Jamison coal, which had passed over a screen having 1 1/4 in. openings and both series of tests were fired with coal from the same car. This is a Pennsylvania high volatile bituminous coal from the Latrobe region, Pittsburgh vein and, except in being screened instead of run of mine, it is fairly representative of the coal used in freight service on Pennsylvania locomotives. An approximate analysis of coal used in the tests follows:

Fixed carbon, per cent.....	54.00
Volatile matter, per cent.....	31.00
Moisture, per cent.....	0.92
Ash, per cent.....	14.08
Total.....	100.00
Sulphur, separately, per cent.....	1.14
Caloric value, B. t. u. per lb. of combustible.....	15,258
Caloric value, B. t. u. per lb. of dry coal.....	13,088

The fact that the fuel used was not run of mine is another feature which should be considered, especially from the fuel consumption standpoint. With run of mine coal and no arch there is a loss of fuel because of a certain percentage of the fine particles passing out through the tubes unconsumed. With the arch a large proportion of these particles will doubtless be consumed during their passage over the brick work.

BOILER PERFORMANCE

From the standpoint of the boiler, the tests show that with the arch there was an appreciable increase in the draft, especially at the high rates of combustion; that there was an increase in firebox and smokebox temperatures; an increase in evaporation at all rates of combustion; a decrease in smoke density; an improved equivalent evaporation per pound of dry coal and a material increase in boiler efficiency.

Draft.—The nozzle used was common to Pennsylvania practice. It had four projections which might be considered partial bridges and its area was equivalent to a round nozzle of 7 in. diameter. Draft readings were taken in the ashpan, the firebox and both back of and in front of the diaphragm. The arch had but little effect on the draft in the ash pan, but the difference in the firebox was noticeable. At the diaphragm the difference was still more pronounced, being 25 per cent greater in front of the diaphragm and 30 per cent

* Copyright, 1917, by the Pennsylvania Railroad Company.

greater back of the diaphragm when the rate of firing was 100 lb. of dry coal per square foot of grate per hour. The reason for this increase is due to the longer path for the products of combustion when the arch is used. It was also found that the draft was increased at all rates of equivalent evaporation per square foot of heating surface.

Firebox and Smokebox Temperatures.—The temperature in the firebox varied between 2,363 and 2,820 deg. F. with the arch and between 2,050 and 2,610 deg. F. without the arch for the different rates of combustion. Through the average rates of fuel combustion, the increase in firebox temperature due to the arch was 100 deg. F. This difference for the smokebox was about 30 deg. F. The smokebox temperature varied from 456 to 609 deg. F. with the arch and 426 to 529 deg. F. without the arch.

Evaporation.—Fig. 1 shows how the arch increases the amount of water evaporated for all rates of combustion. At combustion rates between 4,000 and 6,000 lb. of dry coal per hour, the percentage increase in evaporation is nine per cent. Had the arch tubes been removed and run of mine coal used instead of screened lump, this difference would have been greater. There is shown in this chart a point corresponding to a fuel rate of 13,000 lb. an hour. This was made

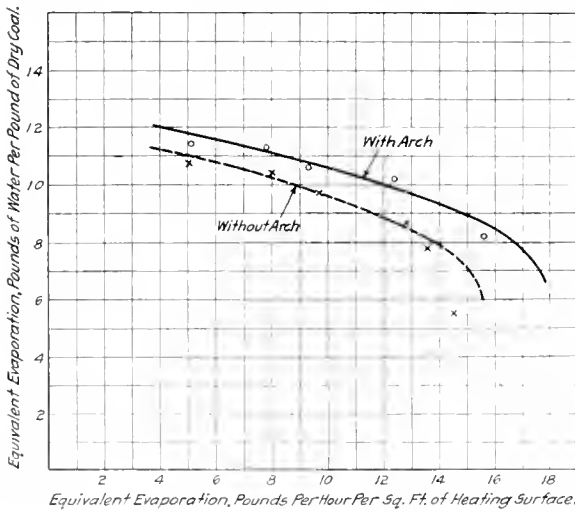

Fig. 2—Rate of Evaporation and Evaporation per Pound of Coal

in test 5,015, the data for which is shown in the table. During this test the locomotive was driven far beyond its true or normal capacity without an arch; in other words the fuel was fired at such a rate that the efficiency of combustion fell off greatly. It is interesting to observe that the locomotive evaporated 54,000 lb. of water per hour at a fuel rate of about 8,000 lb. with the arch, while without the arch a fuel rate of 13,000 lb. was required to evaporate the same amount of water. It will be seen that at this high rate of combustion in the no arch test, it was only possible to maintain a boiler pressure of 185 lb., that only 4.1 lb. of water was evaporated per lb. of dry fuel, that the boiler efficiency was only 40.6 per cent, that 76 per cent smoke was produced and that 5.4 lb. of fuel was required per drawbar horsepower. This is again shown in Fig. 5, which gives the amount of coal fired per drawbar horsepower.

By referring the data to an equivalent evaporation from and at 212 deg. basis, the results show a saving for the arch of from six to ten per cent as the firing rate is increased from minimum to maximum. By plotting the equivalent evaporation of water per hour per square foot of heating surface against the equivalent evaporation of water per pound of coal (Fig. 2) it is found that the arch effected an increase in the

evaporation per pound of dry coal ranging between 7.4 and 18 per cent as the evaporation per square foot of heating surface was increased from 5 to 14 lb.

Boiler Efficiency.—The increase in boiler efficiency by the use of the arch is illustrated in Fig. 3. It is plotted against the rate of combustion. The variation is very nearly constant throughout the range of combustion shown, but the percentage increase varies between 0.9 and 11.6 per cent as the rate of firing is increased from 35 to 120 lb. of dry coal per square

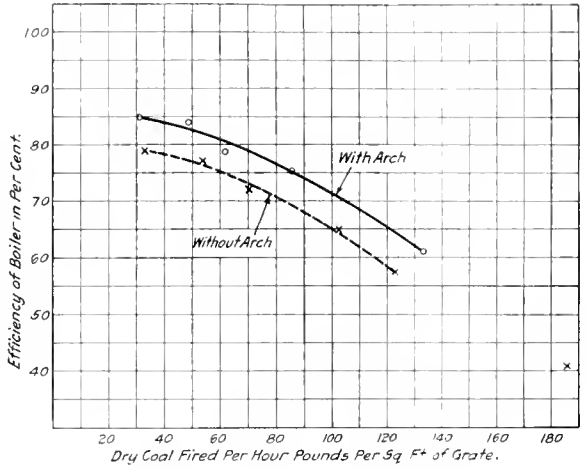

Fig. 3—Rate of Firing and Efficiency of Boiler

foot of grate surface. Comparing the efficiency on the basis of water evaporated per hour, the arch shows a higher boiler efficiency at all rates of combustions.

ENGINE PERFORMANCE

Since, as stated above, the degree of superheat is not increased by the use of the brick arch, it has no direct effect on the engine economy. It does, however, produce an increase in power on account of the greater evaporation, which

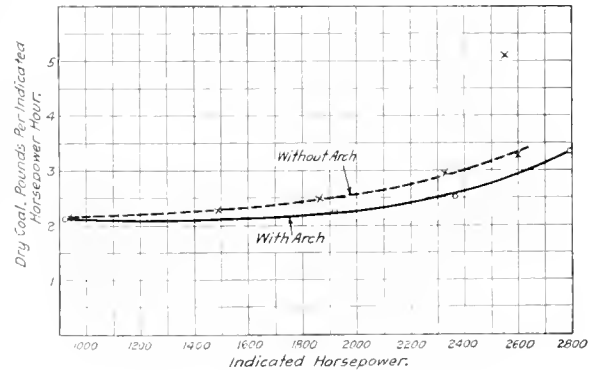

Fig. 4—Indicated Horsepower and Coal Rate

means that a train of a certain tonnage can be hauled at greater speeds than if no arch were used. It will also permit of increasing the size of cylinder if greater hauling capacity is desired. Further, the use of the arch will decrease the fuel consumption for the same train load operating at the same rate of speed as compared to the locomotive without the arch. Fig. 4 shows the relation between the indicated horsepower and the rate of combustion. The increase due to the arch varies from zero at light loads, to 12 per cent at maximum power.

The maximum indicated horsepower obtained with the arch was 2,790 at the 28.9 m.p.h. and with 63.5 per cent cut-off, while with the arch removed but 2,603 indicated horsepower was developed at this speed with a 60.1 per cent cut-off. In test No. 5,015 in which the locomotive without an arch was fired at an excessive rate which reduced the efficiency of combustion, but 2,551 indicated horsepower was obtained with a 64.2 per cent cut-off. In this case the arch test

for different rates of combustion taken from the curve in Fig. 5 is as follows:

Coal fired	Drawbar horsepower			Percentage Difference
	Arch	No arch	Difference	
3,000	1,250	1,080	170	15.7
4,000	1,680	1,440	240	16.7
5,000	2,000	1,750	250	14.3
6,000	2,250	1,990	260	13.1
7,000	2,450	2,180	250	11.5

The additional power made possible by the use of the arch gives an increase in drawbar pull at speeds above 8 m.p.h.

A point indicates the fuel rate of 13,000 lb. an hour in Fig. 5. This is from test 5,015 referred to above and plainly indicates the break in the curve for the no arch test. No such break is indicated for the arch test and it would have been interesting had these tests been carried further to determine where a similar break would occur with the arch.

In reviewing these tests, attention has been called to the fact that a coal high in volatile matter was used. Tests conducted on the Pennsylvania testing plant a number of years ago with an improvised form of arch without water tubes and with a similar grade of coal, and also a coal having less volatile combustible, indicated that the advantages of the arch were not so great with low volatile fuel. In both these tests and the tests described above, it was found that the excellent results obtained with the arch are due principally to the mass of the heated brick in the firebox and the long passage the heated gases are made to travel. In both cases more complete combustion is obtained before the products of combustion reach the tubes than when no arch is used. A brick arch placed in the firebox of a locomotive is, therefore, of considerable advantage as less fuel is required per unit of work done and the capacity of the boiler is increased.

SAVING EFFECTED BY BREAKING SCRAP

Although the management of every railroad attempts to produce transportation at the lowest possible cost and great care is taken to secure the maximum efficiency in shop operation, in the complex organization of the railroad, the minor factors are apt to be slighted and there is a tendency to overlook the possibilities of securing increased revenue from those sources which might be called the by-products of transportation. An interesting instance of saving effected in an unusual manner is the practice of breaking scrap before disposing of it which has recently been instituted by the Buffalo, Rochester & Pittsburgh. So far as we have been able to ascertain there are very few roads which are following this practice, but the method is so profitable that it will,

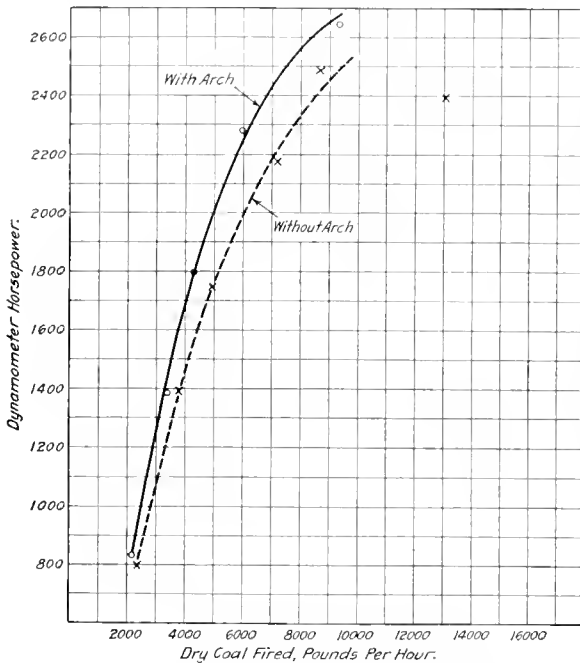

Fig. 5—Coal Fired and Dynamometer Horsepower

showed an increase in indicated horsepower of 9.4 per cent over the test without the arch; at the same time the test without the arch required 39.5 per cent more coal fired per square foot of grate surface per hour than the test with the arch.

LOCOMOTIVE PERFORMANCE

The effect at the drawbar of the use of the brick arch is to decrease the coal consumption per drawbar horsepower

Test number	5,006	5,017	5,007	5,012	5,008	5,013	5,009	5,014	5,010	5,016	5,015
Brick arch?	Yes	No	Yes	No	Yes	No	Yes	No	Yes	No	No
Revolutions per min.	80	80	80	80	120	120	120	120	160	160	160
Cut-off (per cent)	30	29.6	47	47.9	47.2	47.3	58.3	57.6	63.5	60.1	64.2
Duration of test (hours)	2.00	2.00	2.00	2.00	1.00	1.00	1.00	1.00	1.00	0.75	0.50
Speed (m. p. h.)	14.5	14.4	14.5	14.5	21.7	21.7	21.7	21.7	28.9	28.9	28.9
Boiler pressure (lb.)	204.6	205.2	205.2	205.0	205.3	205.4	204.6	204.4	204.3	202.5	185.0
Dry fuel fired (lb. per hr.)	2,179	2,304	3,391	3,758	4,309	4,923	5,999	7,725	9,332	8,624	13,018
Dry fuel fired per sq. ft. of grate	31.0	32.8	48.3	53.5	61.3	70.0	85.4	102.1	132.8	123.7	185.3
Water delivered to boiler (lb. per hr.)	19,493	18,991	20,661	30,150	35,138	36,676	46,370	47,570	58,227	50,395	53,898
Water evaporated per lb. dry fuel	9.0	8.2	8.8	8.0	8.2	7.5	7.7	6.6	6.2	5.8	4.1
Equivalent evaporation:											
Per hr. per sq. ft. heating surface	5.1	5.0	7.8	8.0	9.3	9.7	12.4	12.8	15.6	13.6	14.5
Per lb. dry fuel	11.4	10.7	11.3	10.4	10.6	9.7	10.2	8.7	8.2	7.8	5.5
Boiler horsepower	7.22	7.11	11.12	11.33	13.25	13.84	17.67	18.18	22.26	19.36	20.62
Efficiency of boiler	84.8	79	83.9	77.1	78.7	71.9	75.4	64.8	61.0	57.5	49.6
Dry steam to engines (lb. per hr.)	17,513	16,931	27,861	27,360	34,976	34,516	46,260	45,598	58,163	49,701	53,898
Indicated horsepower	926	938	1,486	1,491	1,918	1,806	2,364	2,333	2,790	2,603	2,551
Dry fuel per i. hp. hr.	2.11	2.19	2.14	2.29	2.28	2.48	2.83	2.95	3.34	3.27	5.10
Dry steam per i. hp. hr.	18.93	18.06	18.74	18.35	18.23	18.50	19.56	19.55	20.84	19.10	21.13
Drawbar pull (lb.)	21,602	20,936	35,907	36,130	31,004	30,193	39,362	37,586	34,284	32,218	31,070
Drawbar horsepower	834	803	1,386	1,394	1,795	1,748	2,279	2,176	2,649	2,487	2,398
Dry fuel per d. b. hp. hr.	2.4	2.6	2.3	2.5	2.4	2.3	2.6	3.2	3.5	3.4	5.4
Dry steam per d. b. hp. hr.	21.0	21.1	20.2	19.6	19.5	19.2	20.3	21.4	22.0	20.0	23.5
Machine efficiency of locomotive (per cent)	90.0	85.6	93.2	93.5	93.6	93.7	96.4	93.4	94.8	95.5	94.0
Thermal efficiency of locomotive (per cent)	8.3	7.6	8.5	7.9	8.1	7.3	7.4	6.2	5.5	5.7	3.6

and to raise the maximum drawbar horsepower. Both of these results are well illustrated in Fig. 5. The percentage increase over the no arch locomotive in drawbar horsepower

no doubt, be adopted wherever scrap is handled in considerable quantities.

Large castings, such as cylinders, driving wheel centers,

deck castings, etc., cannot be sold to foundries and are usually bought by scrap dealers, who must unload the castings, break and reload them, also paying freight charges. As under ordinary conditions the broken scrap brings about \$14 a ton and the unbroken castings only \$8 a ton, the business of breaking up the castings is profitable for the scrap dealer, but it is still more profitable for the railroads, who do not have the cost of the extra handling and the freight charges to meet.

The road above mentioned is now making a practice of carrying all large castings to a pit, where they are broken by dropping a large weight on them, a 15-ton locomotive crane being used to raise the weight and also to handle the castings when necessary. About 26 tons of castings may be broken in a day, the cost per day for operation of the hoist being as follows:

Engineer, 10 hrs. at 34 cents.....	\$3.40
Coal, ½ ton at \$1.25.....	.63
Valve oil, one pint at 48 cents per gal.....	.06
Engine oil, 1 qt. at 28 cents per gal.....	.07
Miscellaneous supplies.....	.10
Repairs, including general repairs.....	.91
	<u>\$5.17</u>

Interest and depreciation are not included in these figures and if they were added, the cost of operation would be between \$8 and \$10 a day.

The locomotive crane is, of course, used for general service and the only special equipment required for breaking scrap

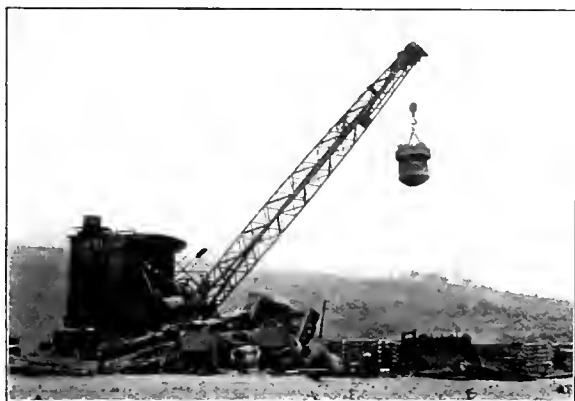

Locomotive Crane Breaking Large Scrapped Castings

is two weights, the larger weighing 8,000 lb. and the smaller 3,500 lb. These have convex bottoms for breaking the castings, while the tops are flat to enable the magnet to catch them readily.

Taking the maximum figure of \$10 a day as the cost of operation of the hoist, the cost of breaking scrap is as follows:

Cost of hoist per day.....	\$10.00
Labor, one helper at 20 cents per hour.....	2.00
	<u>\$12.00</u>

The value of the scrap is:

Broken scrap, 26 tons at \$14 per ton.....	\$364.00
Unbroken scrap, 26 tons at \$8 per ton.....	208.00
	<u>572.00</u>
Increase in value.....	\$156.00
Cost of breaking.....	12.00
Net gain by breaking scrap.....	<u>\$144.00</u>

Of course this saving is not made every day, as it is only about once a month that a carload of large scrap accumulates, but the gain in a year's time is a considerable item. It would seem a measure of economy for all railroads to break their large scrap castings, even though circumstances required the use of a much less efficient method than that herein described.

PROMPT ACTION BY THE RAILWAYS IN THE WAR

Plans for the co-ordination of activities of the railways of the United States so that they will be operated practically as a single system in meeting the transportation needs of the country were adopted at a meeting of more than 50 railway executives held at Washington, April 11, at the call of Daniel Willard, president of the Baltimore & Ohio, and chairman of the Advisory Commission Council of National Defense. General authority to formulate the policy of operation was placed in the hands of a special committee on National Defense of the American Railway Association, of which Fairfax Harrison, president of the Southern Railway, is chairman. This committee consists of 28 railway executives and it is divided into six departments, each to correspond with one of the military departments of the army, and its work will be supervised by a central executive committee to sit at Washington, comprised of Mr. Harrison; Samuel Rea, president, Pennsylvania Railroad; Howard Elliott, chairman, New York, New Haven & Hartford; Julius Kruttschnitt, chairman executive committee, Southern Pacific; and Hale Holden, president, Chicago, Burlington & Quincy, with Mr. Willard as a member ex officio.

At this meeting the following resolutions were adopted: "Resolved, that the railroads of the United States, acting through their chief executive officers here and now assembled, and stirred by a high sense of their opportunity to be of the greatest service to their country, in the present national crisis, do hereby pledge themselves, with the Government of the United States, with the governments of the several states, and with one another, that during the present war, they will co-ordinate their operations in a continental railway system, merging during such period all their merely individual and competitive activities in the effort to produce a maximum of national transportation efficiency. To this end they hereby agree to create an organization which shall have general authority to formulate in detail and from time to time a policy of operation of all or any of the railways, which policy, when and as announced by such temporary organization, shall be accepted and earnestly made effective by the several managements of the individual railroad companies here represented."

For some time past, the Special Committee on National Defense of the American Railway Association, which was appointed at the request of President Daniel Willard of the Baltimore & Ohio as chairman of the committee on transportation and communication of the Advisory Commission of the Council of National Defense, has been working in co-operation with the office of the quartermaster general of the army of the United States, making plans to promote, in case of war, the effective use of the country's transportation facilities. These preliminary plans have now been completed and the general principles on which they have been based are explained in a statement issued by Fairfax Harrison, president of the Southern Railway, and general chairman of the Special Committee on National Defense, as follows:

"The plan of operation worked out here is in distinct contrast to that adopted in England at the outset of the war. There the government immediately assumed the responsibility for the operation of the railroads and exercised its authority to that extent through a committee composed of the heads of the principal lines. The government guaranteed that the net earnings of the companies would continue to be what they had been before the war started.

"In this country the plan is that the government shall advise the railroads what service it requires and the responsibility will be upon the railroad managers to provide that service. When working to that end the railroads of the country will be operated practically as one system.

"It is planned to place the responsibility upon experienced

railroad officers for producing results and the government's only function is to determine what the requirements are. It is the belief of railroad companies that this will not only work for efficiency of service but for economy in cost as well. The above plan of co-operation between the government and the railways is most desirable as the latter are keenly appreciative of this opportunity to demonstrate to the country at large the value in time of war of railroads with elastic management.

"It is believed that the transportation companies will be able to afford to the government expeditiously all the service it may require without substantial interference with the commercial interests of the country. The government's business will receive preferential movement, but it is not anticipated that ordinary traffic will experience abnormal delays."

Sub-committees have been appointed from various branches

Young, mechanical engineer, Chicago, Burlington & Quincy.

One of the important studies to be made by this committee is that of adapting existing cars to meet the needs of military service.

MCCLELLON WATER-TUBE FIREBOX

A water-tube firebox designed primarily to reduce the cost of maintenance and which also increases the firebox heating surface, has been in the process of development for a number of years by James M. McClellon, of Everett, Mass. A few years ago one was built and applied to a Boston & Maine locomotive. From the experience gained by that installation another design has been made and two have been applied to locomotives on the New York, New Haven & Hartford. It has been the aim of the designer to eliminate the use of stay-



J. T. Wallis
General Superintendent of Motive
Power, Pennsylvania Railroad



C. E. Chambers
Superintendent of Motive Power,
Central R.R. of New Jersey



C. A. Lindstrom
Assistant to President, Pressed
Steel Car Company



F. W. Mahl
Director of Purchases, Southern
Pacific



Peter Parke
Chief Engineer,
Pullman Company



R. E. Smith
Gen. Superintendent of Motive Power,
Atlantic Coast Line



C. B. Young
Mechanical Engineer,
Chicago, Burlington & Quincy

of railway service. They are as follows: Military Equipment Standards; Commission on Car Service; Military Transportation Accounting; Military Passenger Tariffs, and Military Freight Tariffs.

J. T. Wallis, general superintendent motive power, Pennsylvania Railroad, is chairman of the Military Equipment Standards sub-committee and associated with him on this sub-committee are: C. E. Chambers, superintendent motive power, Central of New Jersey; C. A. Lindstrom, assistant to president, Pressed Steel Car Company; F. W. Mahl, director of purchases, Southern Pacific; Peter Parke, chief engineer, The Pullman Company; R. E. Smith, general superintendent motive power, Atlantic Coast Line; C. B.

bolts and to divide the firebox into individual units which may better resist the expansion and contraction forces in service and which may be renewed with but little difficulty. The only staybolts used in the firebox are in the throat and the foundation or mud ring, which is a chamber 7½ in. by 6 in., extending along the sides and back of the firebox. The sides and back-head are made up of 6 in., 5¾ in. and 5 in. water tubes, and the crown is made up of three drums. Its construction is clearly shown in the illustrations. The tubes connect the drums with the foundation ring. The boiler is provided also with a combustion chamber 4½ in. long, the sides of which are made up of tubes. These tubes follow the inside contour of the shell and extend from the outside drums

to a circulating chamber, which extends between the tube sheet and the throat. Throughout the construction of the firebox, autogenous welding plays an important part and without it this type of firebox would not have been possible.

The drums are shown by themselves ready for application in one of the photographs. The outside drums are $148\frac{1}{4}$ in. long, 23 in. outside diameter and $1\frac{1}{2}$ in. thick, with the exception of a boss 6 in. wide and $1\frac{3}{4}$ in. thick, into which the side water-tubes are fitted. These drums were made from a

anometer, and $\frac{1}{2}$ in. thick. It has a flat surface $8\frac{1}{2}$ in. wide on both sides, where it is riveted to the side drums. The back drum head is $5\frac{5}{8}$ in. thick and is reinforced by a $1\frac{1}{2}$ in. liner $16\frac{1}{2}$ in. wide at the openings for the cab turret and injector checkvalve. This drum has a single riveted butt seam similar to the side drums, being welded for a distance of $11\frac{1}{2}$ in. back from the front end. The front ends of all three drums open directly into the barrel of the boiler, which is of the same design as the regular type of locomotive boiler and is equipped with a superheater. The whistle and safety valve openings are located in the middle drum.

The sides of the firebox are made up of fifteen 6-in. tubes,



Combustion Chamber for McClellon Firebox



General Arrangement of the McClellon Locomotive Firebox

$1\frac{3}{4}$ in. plate, being planed to $\frac{1}{2}$ in. in thickness, the boss alone remaining the full thickness of the sheet. This boss may be obtained by a less expensive method and was only made in this manner because at the time the firebox was made no other suitable method was available. The front end of these drums is shaped to fit the barrel of the boiler and to make suitable connection with the tube sheet. The two side drums are butt welded for $12\frac{1}{4}$ in. back from this end to facilitate

equally spaced for over a distance of 91 in., which gives sufficient space between each tube to allow for expansion. These tubes are expanded and belled into both the foundation ring and the side drums. They are $\frac{1}{4}$ in. thick and are swaged to $3\frac{15}{16}$ in. at each end. Four of the tubes on each side have two lugs of 2 in. diameter and 1 in. high welded to them to support the lagging and jacket. The corner tubes have two tubes of the same diameter spliced on to them by welding, to give the necessary slope to the back-head. Three $2\frac{1}{2}$ in. holes drilled in these tubes at each splice form the water connection between them. There are eight $5\frac{3}{8}$ in. tubes in the back-head—four each side of

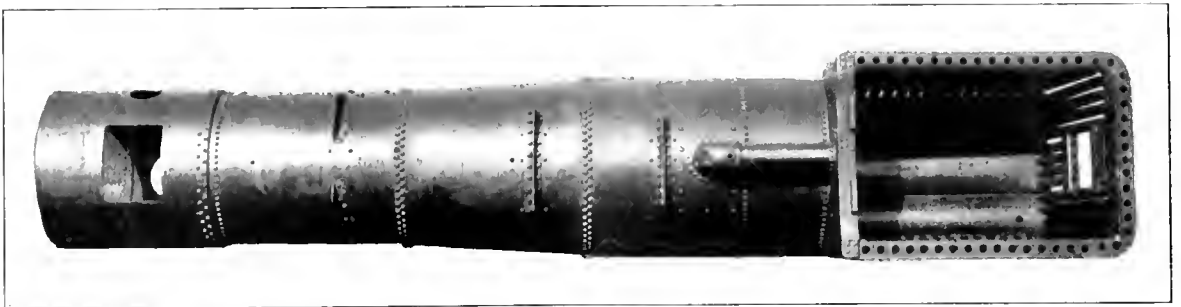

Bottom View of a Locomotive Boiler Equipped with the McClellon Water-Tube Firebox

shaping and for the remainder of their length have a single riveted butt seam with $5\frac{1}{2}$ in. by $7/16$ in. inside and outside welt stripes. They are round in the central portion, with the exception of a flattened surface $8\frac{1}{2}$ in. wide, where they are riveted to the middle drum. They are slightly deformed at the back end to receive the back head water-tubes.

The middle drum is $148\frac{3}{4}$ in. long, 32 in. outside di-

the firedoor. Four 5 in. tubes connect the upper firedoor header with the middle drum. This header is formed by flattening a $6\frac{3}{4}$ in. tube and welding it to the long back-head tubes on each side of it. A $3\frac{1}{2}$ in. hole is drilled in each of these tubes to make a water connection between them and the header. The short tubes are rolled into this header through $2\frac{1}{2}$ in. plug holes in the under side of

the side drums at the top and the circulating chamber at the bottom, being curved to the shape of the boiler shell. They are expanded into the drum and the circulating chamber. The circulating chamber consists of a $5\frac{1}{8}$ in. flanged plate. A second flanged plate, located on the outside of the shell and similar in shape to the one which receives the tubes, is provided with plug holes opposite each tube, through which the roller and bell tools may be used to expand the combustion chamber tubes in the upper flanged plate of the circulating chamber. The bottom ends of the two back tubes on each side are welded in place as, on account of the throat, it is inconvenient to roll them. There is a direct connection between the boiler barrel and the circulating chamber and also between it and the throat. Since this firebox was built, Mr. McClellon has re-arranged this circulating chamber, making it of much simpler construction, but accomplishing the same purpose. The firebox is lagged with a layer of high temperature cement, which is filled in around each tube almost to the center and for a half-inch outside of it. This cement is also reinforced by steel-crete expanded metal and on the outside of this is placed $1\frac{1}{2}$ in. Thermofelt lagging, on which the jacket is applied. The 12-in. feed pipe extending between the last boiler course and the throat is lagged with asbestos cement and jacketed.

These fireboxes were applied to two of an order of 15 Mikado locomotives, weighing a little over 250,000 lb. The firebox heating surface of the ordinary boiler was 229 sq. ft. and of the McClellon boiler 308 sq. ft. There was also a little larger amount of heating surface in the fire tubes in the McClellon boiler and the total square feet of heating surface, including the superheater flues, was 2,827 sq. ft. for the ordinary boiler and 2,937 sq. ft. for the McClellon boiler. The locomotives have not been in service long enough to determine the benefits to be derived from the McClellon firebox.

FIRING ENGINES AT ENGINE HOUSES*

BY A. E. LANGRECK

General Foreman, Terminal Railroad Association, St. Louis, Mo.

For some years we have experimented and tried in various ways to overcome black smoke, when firing up engines, but it may be said at the outset that on account of conditions peculiar to St. Louis, the total elimination of smoke is an impossibility. Methods of firing up locomotives, which have proved successful with non-volatile coal are not applicable here, as we are restricted to bituminous coal. For the purpose of combating the smoke evil our locomotives have been equipped with a smoke eliminating device, but as it is operated by the steam of the locomotive, it cannot be used until steam is generated in the boiler. Its successful operation also depends on the heat of the bed of fire in the firebox, and it does not really become effective until a good fire has been kindled. It is a well-known fact that forced draft wastes fuel and produces smoke.

While firing up does not require a man of high intelligence, it does, however, require a man with some experience. In the larger cities such as St. Louis, where opportunities for employment are many, this class of labor is a mobile one, and for this reason we frequently have to use inexperienced men. Much depends on the way the fuel is placed in the firebox, as well as upon the way it is ignited and the draft used. Experience has shown that the best way to teach these men is by actual demonstration; verbal explanation and instructions generally are not understood by them. In experimenting with various forms of kindling, we found that oil required more attention and blowing and made more smoke than any other kindling material. We have tried kindling by spraying oil on to the fuel through the fire door, by inserting a burner under the grates or through the fire

door, and in every case we made smoke. However, if enough oil is used and the coal is thoroughly kindled, a quick fire can be obtained, and the steam will be generated quickly, quicker, perhaps, than with wood, unless a lot of oil is used to kindle the wood. Oil soaked shavings are not quite as objectionable as a smoke producer, probably because they can be made to kindle the coal slower. Perhaps the best results in firing up bituminous coal, where time is no particular object, have been obtained by using dry shavings, properly placed and lit with a handful of greasy waste. By manipulating the blower very good results were obtained. At our terminal, shavings not being readily available, we use old ties, chopped up by means of an air driven chopper.

We have found that the inverted fire gives the best results. We spread the coal all over the grates about 4 in. deep in the middle, sloping up to a height of 12 in. or more along the side sheets, making a kind of a trough in the center, in which the wood is placed lengthwise, the layer of wood extending from the door to the tube sheet. From $1/16$ to $1/8$ of a cord of wood is used, depending on size of the firebox and the time the engine is wanted. If given sufficient time, a very few sticks of wood will suffice. The wood is ignited by means of oil soaked waste, which has been used previously in wiping engines. If the engine is cold, the house blower is used; where the engine has 40 lb. or more of steam, its own blower is used. The blower is used gently at first, and gradually increased as the coal is ignited. About 15 minutes elapse before it becomes necessary to increase the blower and about 30 minutes before it is put on wide open. On a boiler filled with cold water steam will be generated in about 40 minutes, and 100-lb. pressure is secured in from 70 to 80 minutes. We found that one great factor in smoke elimination in firing up, was to avoid adding coal to the already thoroughly ignited fire. We place enough coal in the box not only to generate the amount of steam required to take the engine out of the house, but also, if possible, to hold the steam pressure until the engine crew takes charge of it and gets it ready for service. Where an engine is fired up from two to four hours before departure from 1,200 to 1,800 lb. of coal is required, depending on the size of the firebox and the boiler. This refers to engines fired up with cold water. Where the boiler has 50 lb. or more pressure a little less coal is necessary. Weather conditions have a great deal to do with the smoke problem. When the weather is murky, or the barometer is low, smoke hangs low with a tendency to spread after leaving the stack.

Just a few words on the cleaning of fires. We clean about 80 fires a day, principally on yard engines, as most of the road engines require that the fire be dumped. Generally it is found harder to clean a fire without making smoke than to build one, where plenty of time is available. Our rule is to clean one-half of the box at a time, shoving the live fire over to the other side, the grates being bared by shaking and the removal of the clinker. A sufficient amount of coal is then placed on the grates and the live fire from the other side is raked over this coal. The other half of the grates is handled in the same manner. Only a blower is used while cleaning, but immediately on closing the fire door the smoke eliminating device is put to work. The time used in cleaning fires varies from 6 to 25 minutes, depending on the size of the firebox, the condition of fire, and the construction of the grates. We find that when road engines come in from long runs it pays to knock out the fire, when neither the condition of the firebox nor repairs would make it necessary. A marked improvement has been made in the elimination of smoke in the engine terminals at St. Louis. All of the engine house foremen in this vicinity have shown an interest in it and we exchange experiences and compare results. By keeping in constant touch with the men that actually do the firing and cleaning we may do better in the future.

* From a paper presented at the convention of the Smoke Prevention Association.

ECONOMICS OF THE SHOP POWER HOUSE

BY V. T. KROPIDLOWSKI

I

A large percentage of the machine tools in locomotive repair shops are now driven by electricity, and electric drive is almost entirely used whenever new shops are built. With the development of this situation, public utility companies have begun to see in it a good opportunity for building up a power load capable of utilizing the extra daytime capacity required to meet the night lighting load, and are becoming active in bidding for this business.

One of the claims most frequently made by the central station representatives is that the power can be produced much cheaper in the central stations than it can possibly be produced in the shop power plant. Although it is true in many instances that the private plant is extravagant, due to local conditions sometimes unavoidable, there are many instances in which the private plant is producing energy as economically as it could be supplied by the central station. When taking into consideration the utilization of exhaust steam for heating, a well designed and managed shop plant is capable of producing energy cheaper than it can be purchased from any outside source.

It is the purpose of these articles to consider the merits of the shop power plant as opposed to the central station, as a source of power supply for use in railroad repair shops, on the basis of the available facts. It is not the intention to discuss the question of supplying energy for railroad electrification. Whether a railroad should possess its own plant for this purpose, or purchase its energy from a central station, is a problem involving entirely different elements.

The subject will be treated in three articles. The first will be a general discussion of shop electrification and the factors entering into the cost of power; in the second, these factors will be discussed more in detail and the data on which the assertions in the first are based will be presented. The third will be devoted to an analysis of the cost of construction and the cost of operating an actual shop plant. The cost of power produced by this plant will be compared with the price at which this power could be obtained from a public service plant.

ADVANTAGES OF ELECTRIC DRIVE

Opinions as to the advantages which the electric drive has over the old system of line shaft and belt drive may be divided roughly into two classes: those which are held by the central station representatives and those expressed by disinterested engineers. To facilitate the comparison of these two sets of claims, they have been tabulated below.

ADVANTAGES CLAIMED FOR ELECTRIC DRIVE

Central Station Solicitor's Claims Advantages	Disinterested Engineer's Views Advantages
Reduction of losses from shafting friction, belt racing and belt troubles.	Flexibility; ability to add and relocate machinery.
More flexibility and better machinery arrangement.	Better light due to absence of belting.
More reliable power and steadier speed.	Greater convenience and cleanliness.
Better light, through absence of belting.	Saving of overhead space.
Cheaper insurance due to separated power house.	
Small power house and foundations.	
Saving of shop space.	
More accurate knowledge of the power developed.	
Easier to find machine troubles by use of electric instruments.	
Ability to stop and start machine quickly.	
Disadvantages	Disadvantages
Greater first cost of installation.	Greater first cost of installation.
Cost of operation.	Cost of operation.

Transmission Losses.—It will be noted that the disinterested engineer claims no advantage for the electric drive in the reduction of transmission losses by the elimination of

line shaft friction and belt slip. While this is one of the arguments most frequently used in favor of electric drive, the saving claimed has not been developed in practice. The losses due to shafting friction and belt-slip do not exceed 20 per cent of the total power required, except in a few lines of manufacture, and generally are nearer 10 per cent.

On the other hand, electric line losses are seldom less than five per cent. Placing the average working efficiency of the motors at 85 per cent, it can readily be seen that the power output of the motors is but slightly above 80 per cent of the electric power required at the switchboard.

This is a conservative statement of the situation. The writer knows of shop installations using line shaft and belt transmission, where the machinery, shafting, belting, etc., have been laid out properly and are properly maintained, in which the loss from shafting and belt friction does not exceed 12 per cent. In another case a large amount of heavy shafting and countershafting was removed and the electric drive substituted, but the actual friction loss was not diminished. In order to keep down the first cost of the installation and because of the low head room available, the motors were of the highest speed obtainable, making the ratio of driving and driven pulley diameters too great for economical transmission. Owing to the exceedingly small motor pulleys and the short centers, heavy belt tensions were required, deflecting the shafting and consequently producing heavy bearing pressure and high friction losses throughout the installation.

Reliability of Electric Power.—It is questionable whether electric power is more reliable than the old system of line shafting and belt transmission. The writer's experience, as well as that of others, indicates that in the case of a shop power plant, where the electric power transmission and distributing system is comparatively simple, the two forms of transmission are about equally reliable. Where there are long, high tension transmission lines and a network of distributing systems, as in the case of the public service power plants, it seems reasonable that the chances of interruption due to such causes as severe storms, electrolytic troubles, operating troubles, etc., are increased.

Minor Advantages.—The other claims made by the solicitors which are not upheld by the disinterested engineer may all be grouped under the one claim of "greater convenience and cleanliness."

An electric plant, to require a smaller power house and machinery foundations, must be equipped with steam turbines, otherwise the electric generator demands practically the same size engine as would be required to drive the shop directly through belt and line shaft. On the contrary the engine room must be larger to accommodate the generator and switchboard. In case the power is purchased, of course, the powerhouse may be somewhat smaller, but not materially so, for the switchboard, transformers, motors for driving air compressors, and other auxiliaries will take up practically the space required for the stationary engines.

There is no propriety in the claim that it is easier to find machine trouble with the electric drive. There are no troubles, aside from those due to the electrical apparatus, which can not be detected and located with the naked eye or with one of the other senses.

Steam Transmission Losses.—There is one notable gain that can be derived from the installation of electric power which evidently has been overlooked. It is the elimination of condensation losses in steam lines in the many instances where the steam must be conveyed for considerable distances to small steam engines scattered about the plant. Such steam engines could be replaced by electric motors and transmission losses reduced at least 5 per cent. It is not uncommon to suffer a loss of 10 per cent of the total power delivered at the point of supply where the steam is distributed to several points of consumption through open air or under-

ground pipe lines, say within a radius of about 700 or 800 ft. Considering the mechanical efficiency of a small steam engine to be about the same as that of an electric motor—which is extremely improbable as small steam engines are known to be very extravagant and not at all comparable with electric motors of equal size—and allowing a loss of 5 per cent for the electric transmission line, a saving of 5 per cent would be realized in favor of electricity. In many cases an actual saving as high as 10 to 15 per cent might be realized.

PURCHASED POWER

The central station solicitor naturally charges against the isolated plant everything that he possibly can. He charges the plant with rent, part of the manager's salary and subjects it to quick depreciation, making it put aside from 1/10 to 1/20 of its cost each year for renewal, while continuing to charge interest on the full investment. He does not concede that the use of the exhaust steam from the engines of the shop plant has any material bearing upon the cost of the power. If reminded that the exhaust steam is needed for heating the shop, etc., he tries to prove that the back pressure of the heating system will neutralize any saving thus effected.

While most of the above charges should enter into the cost of power from the shop plant as well as the central station, they are exaggerated when applied to the accounting of an isolated plant. Let us then analyze them.

Fixed Charges Compared.—The shop plant is subject to the same charges as is the central station, with the exception of the expenses of soliciting business, maintaining meters and taking meter readings, the clerical expense of rendering bills and keeping accounts and the heavy cost of distributing lines.

The central station necessarily must have the best and the most expensive machinery in its plant, as the service to be rendered is more exacting. The machinery is harder worked, and owing to the keen competition and the continual development of more economical and improved machinery, it is scrapped earlier. As a consequence the amount to be set aside annually as a sinking fund reserve to cover physical depreciation and obsolescence, must be much greater than for the isolated plant.

According to the reports of the public service commission of an Eastern State, the actual operating expense of a certain large central station forms only 26½ per cent of the total cost of production, the remaining 73½ per cent being made up of overhead and distribution charges. Furthermore, this same company is capitalized at over \$400 per kilowatt capacity. Of course this is an abnormal case of capitalization, but such concerns are capitalized at the rate of \$250 per kilowatt and higher, whereas an up-to-date shop plant can be installed complete for \$75 to \$100 per kilowatt.

Exhaust Steam Heating and Back Pressure.—The assertion that the back pressure imposed on the engine by the heating system neutralizes the gain derived from the utilization of the exhaust is not justified. Any fair minded observer acquainted with steam engineering practice will concede that a plant such as a railroad repair shop, requiring a boiler plant for heating and other purposes, can put in an engine, run it as a reducing valve between the high pressure boilers and the heating system and make what electrical energy is needed more cheaply than it can be produced and delivered at a profit by a central station.

The capital invested for this purpose of course must pay a dividend, if the company is on a dividend paying basis. Since the heating plant, and the same thing is true of the power plant as a whole, is not a producing agency, this dividend must be met by the revenue-producing departments. For example, if a company paying an average of seven per cent on the capital invested can obtain heat, light and power from an outside source at a price equal to the

operating cost for production in the shop plant, plus depreciation, interest, taxes, etc., plus less than seven per cent on the money which would have to be invested to equip the shop plant, then it would be economy to buy heat and electric power as some portion of the income from the revenue bearing departments which would be required to pay the seven per cent on the capital invested in this non-revenue earning department would be available for other purposes. Otherwise the shop plant is a good investment.

Electric Power Contracts.—Power contracts are usually of a most peculiar construction. The purpose of the extraordinary wording of these instruments is to provide for a scale of prices differing for various conditions of power service, all into one agreement. The actual prices in most of these contracts depend upon the amount of power used, allowances for discounts, etc. In some of them the price is based upon the maximum demand, a fixed charge per horsepower of connected load, or on a sliding scale. Where the price of power is fixed on the basis of maximum demand, either a fixed charge is made for each kilowatt of maximum demand, and the actual kilowatt-hours of power consumption is charged for at a fixed rate, a sliding scale of rates may be used, the rate employed depending upon the amount of the maximum power demand.

The actual operation of the maximum demand clause varies considerably, depending on the time element provision. Some contracts are based on a maximum demand for a time limit of half an hour, others for 15 min., and others for the extremely short period of two minutes. The last figure may mean a serious injustice to the purchaser. The limiting period should be at least 10 min., preferably half an hour.

The fixed price, or, as it is sometimes termed, the readiness-to-serve charge, may also be based on the horsepower of motors installed. This method, in some plants, works a hardship upon the consumer, while in others it may be a fair one. Take a plant, for instance, where there is a very large connected load, but only a small portion of it is being used at any one time. In this case the readiness-to-serve charge may often amount to more than the total power bill for the month. In another shop, where at certain months of the year practically the whole connected motor horsepower is in demand, this method is a fair one.

The power companies employing this system uphold it on the ground that it is only fair that they earn interest on the money invested in the plant equipment, which they must have in readiness to furnish the full connected power whenever the customer wills to use it. But it often burdens the individual user with many times over his fair proportion of the total amount required.

There remains but one solution to the problem of securing the most economical power, and that is to determine the comparative cost of purchasing it outside and generating it in the shop. In determining what is the cost of power generated in the shop plant, care should be taken not to overlook all legitimate charges to the power account. If the addition of power generating equipment to the plant necessary for heating and other auxiliary purposes, requires new buildings, the additional investment only should be charged against the power. If more or higher paid men must be employed, this additional expenditure should be also charged. If the manager gets more salary because he has to supervise the generating station, then the additional expense thus incurred should go to the power account. The cost of the power should also include an amortization charge sufficient to replace the capital invested in the equipment at the end of its probable life, interest at the rate which the money could earn and such taxes and insurance as the additional investment requires. If, with all these charges, the investment promises a profit when credited with the cost of power at the central station rate, it is justified.

Car Department

AIR BRAKE LEVER COMPUTATIONS*

BY LEWIS K. SILLCOX
Mechanical Engineer, Illinois Central

The average man on the line has not the time to figure air brake leverage and he is often not conversant enough with mathematical computations necessary to arrive at the proper location of holes for drilling the various levers. The following formulas in connection with Figs. 1 and 2 give an

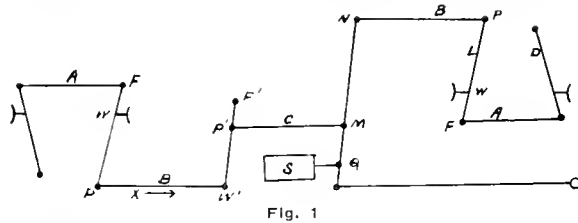

Fig. 1

solutely accurate method for this work together with methods for checking the levers applied to any freight car. Referring to Fig. 1, the letters shown indicate the following parts:

- A = Bottom connection.
- B = Top connection.
- C = Center connection.
- D = Dead lever.
- L = Live lever.
- S = Force from brake cylinder.

In designing the rigging make the live and dead levers the same proportion and use any of the following proportions: 3 to 1, 3½ to 1 or 2½ to 1. The design of the car will determine the length of the levers. The top and

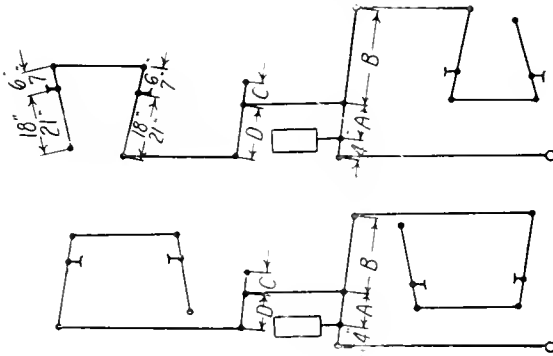

Fig. 2

center connections should pull as nearly parallel as possible. The total braking power should equal 60 per cent of the light weight of the car. Assuming Z = the light weight of the car, we have the following:

- (1) Power required on top connection = $X = \frac{Z \times .60 \times WF}{4 \times PF}$
- (2) Proportions of cylinder lever = $MN = \frac{S \times QN}{X + S}$
- (3) Proportions of floating lever = $W_1P_1 = \frac{S \times W_1F_1}{X + S}$

- (4) Instead of (3) this proportion can be used: $\frac{QN}{QM} = \frac{W_1F_1}{P_1F_1}$
- (5) Use to check band brake end: $\frac{S \times QM \times PF}{MN \times WF} = \frac{A \times .60}{4} = W$
- (6) Use to check end opposite band brake: $\frac{S \times QN \times P_1F_1 \times PF}{MN \times W_1F_1 \times WF} = \frac{A \times .60}{4} = W$

Example: Box car having a light weight of 40,000 lb. with truck levers drilled for holes spaced 6 in. and 18 in. apart, cylinder lever distance Q to N (Fig. 1) or A + B (Fig. 2) to equal 34 in., floating lever W₁ to F₁ (Fig. 1) or D + C (Fig. 2) to equal 17 in.

Total braking power = .60 × 40,000 = 24,000 lb.

1. Power required on top connection = $X = \frac{A \times .60 \times WF}{4 \times PF}$
or $\frac{40,000 \times .60 \times 6}{4 \times 24} = 1,500$ lb.
2. Proportions of cylinder lever = $MN = \frac{S \times QN}{X + S}$
or $\frac{4,000 \times 34}{1,500 + 4,000} = 24.74$ in.
3. Proportions of floating lever = $W_1P_1 = \frac{S \times W_1F_1}{X + S}$
or $\frac{4,000 \times 17}{1,500 + 4,000} = 12.37$
4. In place of following method (3) the following proportion may be used:

$$\frac{QN}{QM} = \frac{W_1F_1}{P_1F_1}$$

$$\frac{34}{9.26} = \frac{17}{4.63}$$

$$157.42 = 157.42$$

Substituting in the above equation we have

$$\frac{34}{9.26} = \frac{17}{4.63}$$

$$157.42 = 157.42$$

Which shows that the calculations are correct.

5. $\frac{S \times QM \times PF}{MN \times WF} = \frac{A \times .60}{4} = W$ or force applied to each brake beam
 $\frac{4,000 \times 9.26 \times 24}{24.74 \times 6} = \frac{4,000 \times .60}{4} = 6,000$ lb.

Air Brake Arrangement.—Locate the cylinder so that the cross tie will not interfere with the removal of the piston,

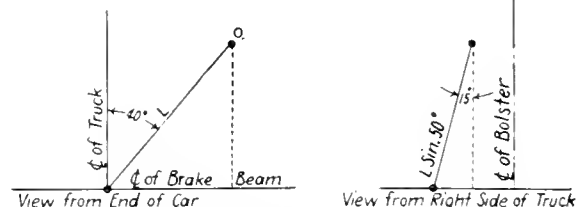
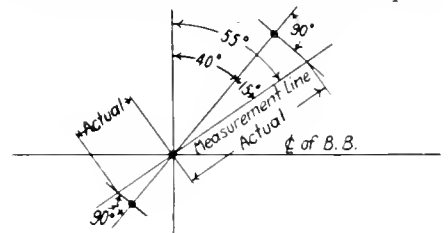

Fig. 3

which requires a minimum distance of 13 in. Check the clearance between the push rod and truss rod strut. See

*From a paper presented to the Car Foremen's Association of Chicago.

that the levers do not interfere with the cross ties or truss rod struts when the brakes are applied, figuring a travel of the live lever of about 15 in. maximum. Minimum push rod travel with new shoes should be 4 in., the maximum with shoes removed, should be 12 in. Check the live lever guide and see that it will allow plenty of travel for the lever, and see that it does not interfere with the application of the top connection.

Truck levers should stand at an angle of 40 deg. from the vertical and should incline towards the bolster at an angle of 15 deg. when the brakes are released. To find the actual length of the lever the following practice will be observed: Lay out on the end elevation the center line of the lever at an angle of 40 deg. from the vertical, and intersect the center line of the car at the center of the brake beam. The measurement line is then laid at an angle of 55 deg. from the vertical, or 15 deg. more than the lever, intersecting at the same point. Measurements are made on this line and projected to the lever at right angles to it. See Fig. 3.

The following is a method of obtaining the height of the dead lever above the center line of the brake beam when the length of the lever is assumed:

The line drawn from point *O* to the center line of brake beam = $L \sin. 50^\circ$.

$$\text{Height} = L \sin. 50^\circ \times \cos. 15^\circ.$$

The following table can be used for locating the holes in the cylinder and floating levers for cars having a truck

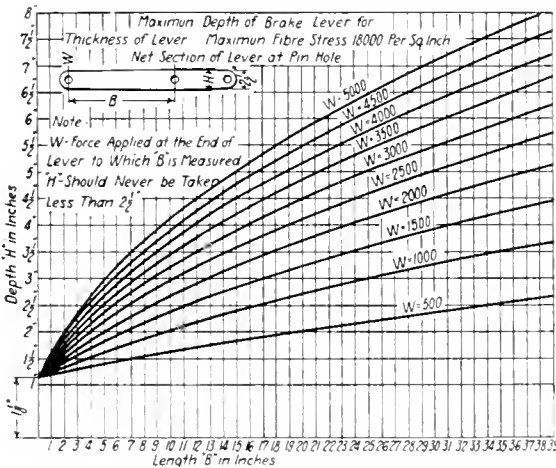

Fig. 4—Proper Size of Brake Levers

lever ratio of 3 to 1 (that is, 6 in. to 18 in. or 7 in. to 21 in. as shown in Fig. 2) and a braking power based on 60 per cent of the light weight of the car:

Light weight of car	Cylinder lever size in.	Floating lever size in.	Holes for cylinder lever		Holes for floating lever		Brake cylinder diameter in.
			A in.	B in.	C in.	D in.	
20,000—21,999	3 1/2 by 1	2 1/2 by 1	7 7/8	26 3/8	3 1/2	13 1/2	8
22,000—23,999	3 1/2 by 1	2 1/2 by 1	8 1/8	25 3/8	4 1/4	12 3/4	8
24,000—25,999	3 1/2 by 1	2 1/2 by 1	8 3/4	25 1/8	4 1/2	12 1/2	8
26,000—27,999	3 1/2 by 1	2 1/2 by 1	9 1/4	24 1/4	4 3/4	12 1/4	8
28,000—29,999	3 1/2 by 1	2 1/2 by 1	10 1/8	23 3/8	5	12	8
30,000—31,999	3 1/2 by 1	2 1/2 by 1	10 3/8	23 1/8	5 1/4	11 3/4	8
32,000—33,999	3 1/2 by 1	2 1/2 by 1	11	23	5 1/2	11 1/2	8
34,000—35,999	3 1/2 by 1	2 1/2 by 1	11 1/2	22 1/2	5 3/4	11 1/4	8
36,000—37,999	3 1/2 by 1	2 1/2 by 1	11 3/4	22 1/4	6	11	8
38,000—39,999	4 by 1	3 by 1	11 3/4	22 1/4	6 1/4	10 3/4	10
40,000—41,999	3 1/2 by 1	2 1/2 by 1	9 3/4	24 3/4	4 3/4	12 3/4	10
42,000—43,999	4 by 1	3 by 1	9 5/8	24 3/8	4 1/2	12 1/2	10
44,000—45,999	4 by 1	3 by 1	9 1/2	24 1/2	5	12	10
46,000—47,999	4 by 1	3 by 1	10 1/4	23 3/4	5 1/4	11 3/4	10
48,000—49,999	4 by 1	3 by 1	10 3/8	23 1/8	5 1/2	11 1/2	10
50,000—51,999	4 by 1	3 by 1	11	23	5 3/4	11 1/4	10
52,000—53,999	4 1/2 by 1	3 1/2 by 1	11 1/4	22 3/4	5 3/4	11 1/4	10
54,000—55,999	4 1/2 by 1	3 1/2 by 1	11 3/8	22 3/8	5 3/4	11 1/4	10
56,000—57,999	4 1/2 by 1	3 1/2 by 1	11 3/4	22 1/4	5 7/8	11 1/8	10
58,000—59,999	4 1/2 by 1	3 1/2 by 1	12	22	6	11	10
60,000—61,999	4 1/2 by 1	3 1/2 by 1	12 1/4	21 3/4	6 1/4	10 3/4	10

The proper size of brake levers is shown in Fig. 4.

CO-OPERATION OF ALL ROADS NEEDED TO REDUCE HOT BOXES*

BY JOSEPH DALZELL
Foreman Car Inspector, Pennsylvania Railroad, Pitsaun, Pa.

Hot boxes on freight cars, what really causes them, and how they may be avoided, are vital questions. We all are agreed that they are a source of great annoyance and expense in taking cars temporarily out of the service and in holding up traffic, and each one of us should be a party to their elimination. If we insist on following old time methods of lubrication these hot boxes, like Hamlet's ghost, will always come back to plague us. If we are to avoid hot boxes we must get after them in a systematic manner, and when the trouble is reduced we must not relax our efforts, as hot boxes are persistent and must be given persistent treatment.

First, we must have a sufficient number of car oilers—men who have had some experience at car oiling and who will take a personal interest in their work. A competent car inspector should have charge of these men and instruct them in their duties, accompanying them on the trains, and seeing that the work is properly performed.

Car oiling, as carried out by the rules of the Pennsylvania Railroad, may be divided into three parts: Preparation of sponging, packing of journal boxes, and examination of journal boxes.

Preparation of sponging.—The waste must be separated into small pieces and not rolled in bunches, and must not be cut. It must be submerged in car oil for 48 hours. Before using it must be placed on a rack and the surplus oil drained off until it contains approximately three pounds of oil to one pound of waste. It is then ready for use.

Packing of journal boxes.—The car oilers should go over the trains, examining each box carefully to see that a thorough back wall of packing has been set up to assist the dust-guard to retain the oil and keep out dirt. The sponging, if disarranged, should be set up to the centre line of journal—not too tight—and if the packing is dry a little oil should be used, placed well back to the rear side of the journal according to the direction the car is to be moved. The packing must be flush with the end of the journal and must not be connected with the plug in the front end of the journal and inside face of box. Cars given this attention should be marked, with chalk, with the month and day directly over each bolster, thus 9-26, as a guide to other car oilers that the boxes have been given attention on that date, and do not necessarily require attention for a period of 10 days.

The inspector having charge of these men should see that no cars are marked in this manner that have not been given the proper attention, as it is our experience that it is not the journals that have been given attention that cause trouble, but the journals that have not been attended to, or those carelessly marked. It is understood that this inspector is held responsible for the work of his car oilers and the economical use of oil and sponging.

Examination of journal boxes.—Car oiling or setting up of the sponging to the journals does not, however, remedy all of the trouble. There are other defects that cause boxes to run hot, no matter how well they may be lubricated, such as worn out or cracked bearings, second-hand bearings applied to new journals, bearings not bearing equally on journals, or rough or cut journals. It is therefore necessary to jack up all hot journals to determine the exact cause of the trouble, and those that cannot be remedied by the application of new journal bearings must be sent to the repair shop for necessary attention.

With the proper care and supervision all of these defects can be remedied and hot boxes very materially reduced, if not altogether eliminated, but this practice must be followed up, not by one road, but by the concerted action of all.

*Entered in Hot Box Competition.

RESISTANCE OF PASSENGER CARS*

Relation of Resistance to Speed for Cars of Various Weights Found by Dynamometer Tests

BY E. C. SCHMIDT† and H. H. DUNN‡

DYNAMOMETER car tests to determine the resistance of heavy passenger trains have recently been made by the department of railway engineering of the University of Illinois on the tracks of the Illinois Central between Champaign, Ill., and Centralia. The tests were made in regular through passenger service. It was found that the specific resistance is materially affected by the weight of the cars composing the train, and that it decreases as the average weight of the cars increases.

The Trains Tested.—The trains experimented upon—18 in number—were all passenger trains, which varied in total weight from 535 to 727 tons. The number of cars varied from eight to twelve. The train make-up was not uniform and is shown for each train in the table. The average gross weight per car in the various trains ranged from 48.7 to 71.1 tons. In 13 of the 18 trains the dynamometer car was coupled with its measuring drawbar toward the rear, and in these cases its own resistance is excluded from the test car records; its weight is consequently likewise excluded from the train weights listed in the table. In the five remaining trains, on the other hand, the resistance of the dynamometer car itself is included in the records and its weight is therefore included in the train weight. Since the test car weighs only 29 tons, the normal average car weight is somewhat lowered in these

Society of Civil Engineers section, while the remaining 63.5 miles are laid with 90-lb. rail of American Railway Association section. Practically all of the northbound track is laid with 85-lb. rail of American Society of Civil Engineers section. All rails are laid with broken joints supported on two ties. During eight months of the year there is employed in maintaining this portion of the road, a force of men averaging one man per mile of track. During the remaining four months this force is reduced to one man for each two miles.

The tests were all made on fair summer days, the air temperature which prevailed during the tests varying from 69 degrees to 93 degrees Fahrenheit. The wind velocity varied up to 25 m. h. p.

Test Methods.—The apparatus within the dynamometer car used produces continuous graphical records of the gross

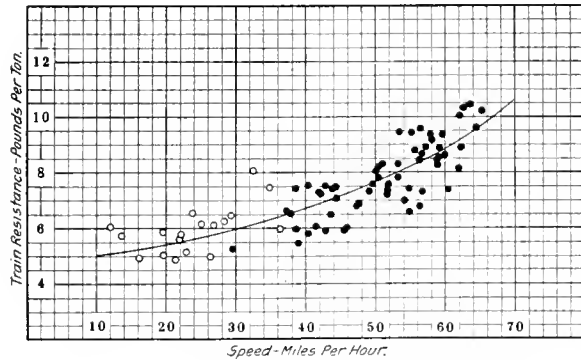

Fig. 1—Relation Between Resistance and Speed for Test 44B

five instances. All but 32 of the 187 cars included in the 18 trains had six-wheeled trucks. Other data defining the train make-up are given in the table.

The tests were made on trains running both North and South. The northbound trains had a scheduled running speed of 47.5 m. p. h. and the southbound trains had a scheduled running speed of 43.7 m. p. h.

Track and the Weather Conditions.—The roadbed on which the tests were made was in good condition and the drainage, in general, was excellent. Except on a few short stretches through station grounds, where cinders and screenings are used for ballast, both tracks are ballasted with broken limestone. The cross-ties, 6 in. by 6 in. by 8 ft., are spaced about 20 in. between centers and are of treated red oak, treated soft wood or untreated white oak. Sixty-one miles of the southbound track are laid with 85-lb. rail of American

resistance of the train, the speed, time, brake cylinder pressure, wind direction and wind velocity. The net weights of all cars were obtained from the records of the Illinois Central and the Pullman Company. To determine the car loads, passengers were counted and allowed for at 140 lb. each; the weights of baggage and mail were estimated by personal inspection and count of the contents of each car; the weight of express was determined by reference to the bills, supplemented by inspection and estimate. The maximum error in the gross train load itself caused by the processes described is less than 1 per cent.

All resistance values here presented have been corrected for grade and for acceleration, and they denote, therefore, the resistance of the train when running at uniform speed on level track. The data do not permit the resistance due to wind to be differentiated and this element of resistance is consequently included in the values presented. Unless otherwise stated, these resistance values are expressed in terms of pounds per ton of gross train weight.

Test Results.—The immediate purpose of the tests was to define for each train the relation between net resistance and speed. On the dynamometer car records for each train there were accordingly chosen a number of points or sections corresponding to as great a variety of speeds as the data

TRAINS USED FOR RESISTANCE TESTS

Test Number	Average Approximate Wind Velocity, Miles Per Hr.	Gross Train Wt. Tons	Cars in Train	No. of Cars Having Three Axles Per Truck	Kind of Cars							
					Test Car	Baggage and Express	Mail	Coaches	Pullmans	Diner	Special	
44A	...	604.5	11	9	...	6	2	2	1
44B	...	570.0	11	9	...	6	6	2	1
46A	20.0	615.48	11	9	...	4	4	4	1
46B	15.0	551.32	10	8	...	3	3	4	1
47	10.0	727.0	11	10	...	1	1	1	4	1
48A	...	538.5	11	11
48B	...	562.0	11	11
49A	20.0	588.2	11	9	...	1	1	1	3	3	1	...
49B	20.0	634.9	10	9	...	1	1	1	3	3	1	...
50A	25.0	601.6	12	9	...	1	5	2	2	1
50B	25.0	535.2	11	8	...	1	5	2	2	1
51A	20.0	618.01	9	8	...	1	1	1	3	3	1	...
51B	20.0	549.02	8	8	...	1	1	1	3	3	1	...
52A	20.0	570.1	11	11
52B	15.0	540.0	11	11
53A	15.0	708.3	10	9	...	1	1	1	4	4	1	...
53B	15.0	639.92	9	9	...	1	1	1	4	4	1	...
54	20.0	606.23	11	9	6	2	2	1

* Abstract of a paper published in Bulletin 194 of the American Railway Engineering Association.
 † Professor of Railway Engineering, University of Illinois.
 ‡ Assistant in Railway Engineering, Engineering Experiment Station, University of Illinois.

presented. At each section the net resistance was calculated and the calculated value with its corresponding speed was plotted on a diagram such as Fig. 1. The black dots define average value of resistance during the passage of the train over several hundred feet of track at a uniform speed and the circles define instantaneous resistance values as the train passes a particular point on the road. In this manner a similar curve has been produced for each of the eighteen trains tested. All eighteen of these curves are brought together in Fig. 2.

An inspection of Fig 2 shows that at 20 m. p. h., the values of resistance vary from 4.1 to 6.3 lb. per ton, and at 70 m. p. h. the values of resistance range from 8.0 to 11.4 lb. per ton. This variation is chiefly due to the differences in the average weights of the cars composing the different trains. Those trains composed of relatively light cars have the higher resistance (expressed in pounds per ton), whereas trains of

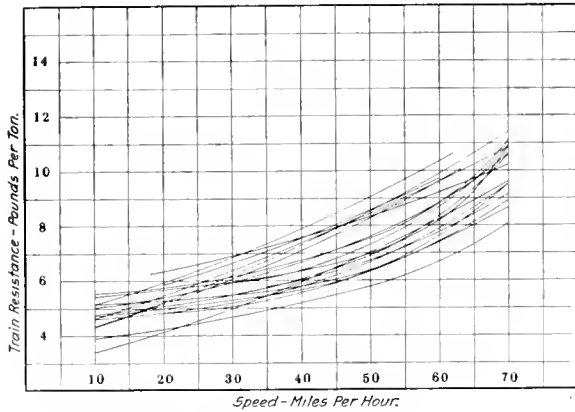

Fig. 2—Relation Between Resistance and Speed for the 18 Trains Tested.

heavy cars have a low specific resistance. This fact is better established by the process described below.

If in Fig. 2 at the point corresponding to 20 m. p. h. a perpendicular is erected, it will cut the curves in eighteen points, each of which pertains to a particular train and defines for that train the average value of resistance at a speed of 20 m. p. h. If each of these resistance values are plotted

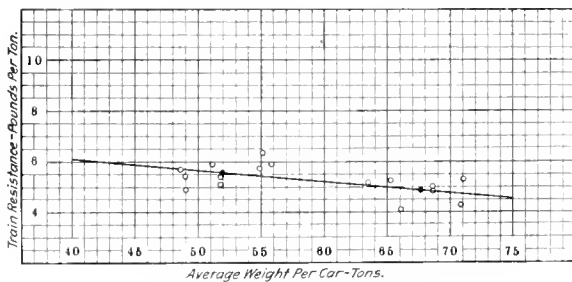

Fig. 3—Relation Between Resistance and Average Car Weight at a Speed of 20 m.p.h.

with respect to the average car weight of the train to which it pertains, the diagram shown in Fig. 3 is obtained. It is obvious that as the car weight increases, the specific resistance decreases. The average rate of this decrease is shown by the straight line. By a similar process, six other such straight lines have been determined defining this relation at speeds of 10, 30, 40, 50, 60 and 70 m. p. h. These six lines, together with those from Fig. 3, are all brought together in

Fig. 4, which shows the average relation between resistance and car weight for each of seven different speeds. This figure, however, presents the relations in unusual form and Fig. 5 has been drawn from Fig. 4 to show a corresponding group of resistance-speed curves.

The relation between the two figures will be made clear by explaining the derivation of the upper curve in Fig. 5—

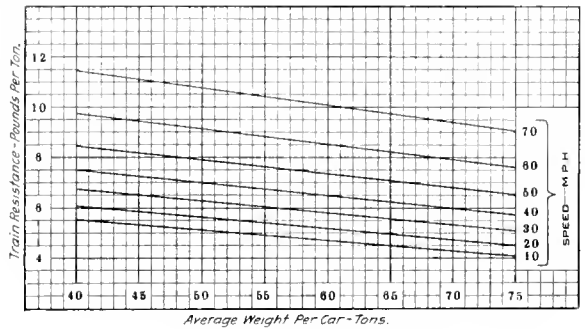

Fig. 4—Relation Between Resistance and Average Car Weight at Various Speeds

the one applying to a car weight of 40 tons. In Fig. 4 the ordinate corresponding to an average car weight of 40 tons cuts the seven lines there drawn at seven points at which the mean resistance values are 5.5, 6.7, 7.5, 8.5, 9.7 and 11.5 lb. per ton, corresponding to speeds of 10, 20, 30, 40, 50, 60 and 70 m. p. h., respectively. These values are the co-ordinates of seven points on a resistance-speed curve applying to a

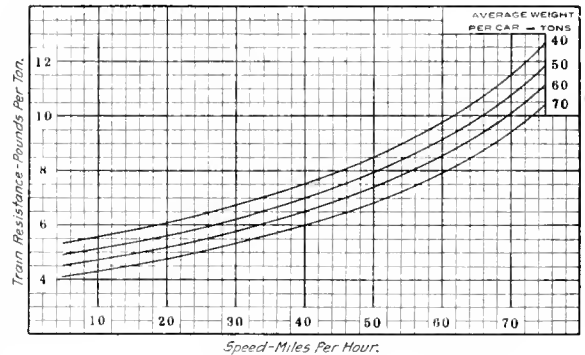

Fig. 5—Relation Between Resistance and Speed for Cars of Various Average Weights

car weight of 40 tons. These seven points have been plotted in Fig. 5 and define there the upper curve.

As these results are all derived from curves such as that drawn in Fig. 1, one must expect to encounter as much variation from the average values as is indicated in this figure. It should be borne in mind that they apply to trains running on level track at uniform speed in warm weather, and under favorable conditions. Cold weather and high winds will both operate to increase the resistance above the amounts shown.

OXY-ACETYLENE WELDING.—The speed at which work can be welded by the oxy-acetylene process varies with its nature. In the following table is given the speed per hour on iron plates:

Thickness of plate.....	3/64 in.	1/8 in.	3/8 in.	1/2 in.
Length welded per hour.....	30 ft.	14 ft.	6 ft.	4 ft.

These figures were obtained when the plates on which the welding was done were cold. By preheating the parts near to the weld in 1/4 in. plates and upwards, the time and cost can be reduced.—*Institution of Mechanical Engineers.*

PREVENT HOT BOXES BY EDUCATION*

BY W. S. CLARK

Car Foreman, New York Central, East Syracuse, N. Y.

The greater number of hot boxes are due to lack of proper attention by what are termed "car oilers," but who should be called "journal box caretakers," as no free oil should be used in properly taking care of journal boxes. When inspecting cars you will find some journal boxes overloaded with packing, while others do not have sufficient. Both of these conditions make hot boxes. Brasses worn thin are in many cases not removed until they have started trouble and you have hot boxes and cut journals.

To eliminate these conditions and have perfect running cars it is necessary first to see that the journal box packing is mixed and properly proportioned with waste and oil. This requires mixing tanks and a "prepared" packing tank, the sizes of tanks to be in accordance with shop or yard capacity. These tanks should have drainage racks in the bottom and be equipped with 1¼-inch faucets. The waste should be pulled apart, placed in the mixing tank and then submerged in oil, and allowed to stand for 24 hours. An exact record should be kept of the number of pounds of waste and the number of gallons of oil used. Then draw off the oil, leaving four pints of oil to one pound of waste. Transfer this packing into the "prepared" tank. Twice daily draw off the oil that has settled in the bottom of the tank and pour it over the top of the prepared packing. By so doing you always have a mixture which is standard.

The treating of journal boxes has become a science, and is not an "everyman's" job. Employees may be educated to become scientific at their work by proper supervision. They should be furnished with books of instruction on the lubrication and care of journal boxes.

Journal boxes which are to be repacked should be handled in the following manner: A uniform size roll, say 2 in. in diameter by 10 in. long, should be made of dry waste and be submerged in oil. Place this roll in the back of the journal box. Then pack the box under the collar of the journal at the front. Force back with the packing iron until it is within one-fourth of an inch of the center line of the journal, making sure that all packing is back of the collar of the journal. Then place a piece of packing by hand in the front of the box, not spudded and having no strings of waste hanging out of the box. Do not pack the box too tight.

The foreman in charge should pack a few boxes for each man assigned to this work, and explain to him why the roll is placed in the back and the piece in the front of the box and why these three operations are necessary. He should then watch the man repack 10 or 12 boxes and correct him each time he makes a mistake, never snatching the packing iron from his hand, but demonstrating to him in a mild manner. When a man has gone over a few boxes you can determine whether he will make good or not, for not every man is fitted to do this work.

In caring for cars in trains in the yard, if the packing needs rearranging sufficient waste should be pulled out of the box and then "spudded" back. Be sure to keep the packing within the one-quarter inch of the center line of the journal; then place the front piece. No packing should be placed at the side of the journal. If the box requires additional packing, it should be placed in the front and "spudded" back under the collar of the journal. A good man at this work will always detect a cut journal or a brass worn thin that will cause trouble. By following these instructions hot boxes may be reduced 98 per cent. Our inspectors always ask the conductors if they have had any trouble on the last trip out, or the trip in, and just what the trouble was. Men educated in this line of work will always be interested in these results.

Every car that comes in on a repair track should be looked

after, all surplus packing removed and the packing rearranged. Cars that need complete repacking should be handled as outlined above. All journal boxes should be thoroughly cleaned out before repacking. All new boxes should be free from rust and scale. The journals should be cleaned when the wheels are changed. In changing wheels see that the brass fits the journal and that the journal bearing wedge fits the brass and box properly.

A foreman in charge of inspectors should always keep in touch with the conductors and train crews to ascertain the running condition of the cars. Find out the side of the train the trouble was on. Then go over the matter with the car ciler. In many cases the conductor or one of the train crew has already told the oiler. Good results follow such co-operation.

We hold monthly meetings with our oilers, the same as we do with our inspectors. They all understand that the care of journal boxes is an important factor in getting cars over the road without delay.

THE CHILLED IRON CAR WHEEL*

BY GEORGE W. LYNDON

President, Association of Manufacturers of Chilled Car Wheels, Chicago

The method of manufacture in so far as the formation of the wheel is concerned, is practically the same today as when first introduced. Fig. 1 shows a section of the mold in which the chilled iron wheel is cast.

The tread, or running surface of the wheel, is formed by an iron ring or chiller against which is poured the molten metal, the sudden cooling transforming the soft gray metal to a metal white in color and harder than tempered steel. This white, hard iron extends all around the tread of the wheel to a depth of one-half to three-quarters of an inch, and yields more mileage per unit of wear than any other metal.

There is no other metal known that produces so hard a tread that can be operated with safety, because if other metals can produce a tread as hard as the chilled iron wheel this same hardness will be apparent in the plates and the hub, which will therefore be brittle and dangerous to use.

A 725 lb. M.C.B. wheel is poured in about twelve seconds.

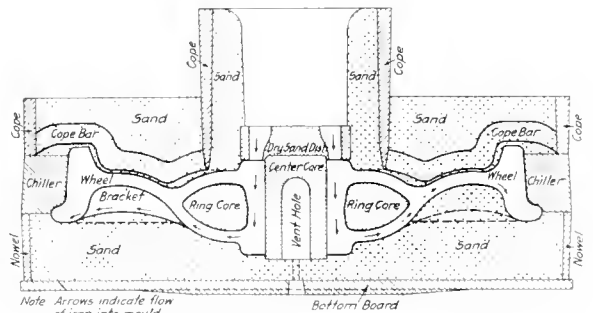

Cross Section of a Car Wheel Mould Showing the Direction of the Flow of the Metal

The molten metal is then subjected to different cooling conditions due to the complexity of the mold. In consequence shrinkage strains are encountered which must be relieved before the wheels are placed in service. During the earlier periods of manufacture, after the wheel was set, it was covered with ashes or hot sand and allowed to remain several days until nearly cold. Another method was to lay the wheel on the floor and apply heat to the tread, so that the temperature of the tread would be brought back to that of the plates and hub.

These crude methods were later displaced with the intro-

*Entered in Hot Box Competition.

*Abstract of a paper presented to the Canadian Railway Club.

duction of cooling pits lined with fire brick, each pit holding from 10 to 15 wheels. Just as soon as the wheel is solidified it is removed from the mold red hot and placed in a pit maintained at the proper temperature, and by this process the tread and the plates and the hub resume an equilibrium of temperature. The wheels remain in the pits for several days until the shrinkage strains are finally removed by the gradual and uniform cooling process.

INCREASES IN CAR CAPACITY AND WHEEL WEIGHTS

A 33-in., 525-lb. chilled iron wheel of the Washburn type became standard soon after the year 1850 for 10-ton freight cars and also for passenger cars. Cars of this capacity remained standard for about 30 years. Under the conditions of light wheel loads, small flange pressures, slow speeds, low annual mileage, which prevailed during that time, the wheels would last the entire life of the car. Wheel mileage obtained under such circumstances is sometimes erroneously used to indicate the superior service of wheels manufactured at that time. The ton-mileage, which is the true basis for comparison, was extremely low as compared with wheel performance at the present time.

The 30-ton car, introduced in 1885, was the heaviest capacity car on any railroad during the time of the World's Columbian Exposition at Chicago in 1893. Its growth was very rapid on all railroads. A chilled iron wheel weighing 600 lb. was used under cars of this capacity and was recommended as standard in 1904 by the Master Car Builders' Association. It was later modified and the weight increased to 625 lb. in the year 1909, upon the recommendation of our association. It was not long before the 40-ton and 50-ton car were developed for the coal carrying trade

weight of the wheel has increased from 525 lb. to 725 lb., or 38 per cent. It will be noted that the percentage of increase in the wheel is much less than that for any other part of the car, and while the carrying capacity has increased from 10 tons to 70 tons, or 600 per cent, the weight of the heaviest M. C. B. standard wheel has increased only 38 per cent. The ton-miles per annum of the present 70-ton car is approximately 20 times that of the 10-ton car, which indicates the greater service given by the present wheel than was secured from any wheel during the pioneer days. It also plainly shows that the mere comparison of mileage is of no value unless the load carried is taken into consideration.

THE FLANGE

There is one part of the wheel that has received scant consideration and that is the flange. During all the remarkable railroad development the space between the running rail and the guard rail has remained fixed at $1\frac{3}{4}$ in. The chilled iron wheel manufacturers have been trying for years to secure a stronger flange and have demonstrated the fact that 3-16 in. can be added to the thickness of the present M. C. B. flange by mounting each wheel 3-32 in. closer to the rail and still maintain the Master Car Builders' standard throat to back of flange dimension of 4 ft. 6 29-64 in. This insures that the relation of the back of the flange to guard rail remains the same as at present and no change in track clearance is required. We have received the approval of our plan from a special committee who were appointed for the purpose of investigation through the American Railway Engineering Association. Our recommendations are shown in Fig. 2, which also shows the development of the flange and tread.

Under the 10-ton car, the weight of which was about equal to its capacity, the load carried per wheel was approximately 5,000 lb., which would require about 4,000-lb. flange pressure to change the direction of the truck in engaging curves. Under the 70-ton car the load per wheel has increased to 25,000 lb., which requires almost 20,000 lb. flange pressure to change the direction of the truck; therefore, the flange thrust has increased 400 per cent on account of the increased load, which is further augmented by the high speed of modern freight trains. Under present conditions of operation, considering the increased load and speed, the thrust on the flange including impact is at least 10 times greater than under the old 10-ton car; it must be apparent that the increased duty has not been provided for.

Tests made at the University of Illinois for the purpose of ascertaining the stresses to which the wheel is subjected in pressing it onto the axle and under service conditions, have shown that when a wheel is pressed on an axle a compressive stress is developed radially and a tensile stress circumferentially; that the plate must carry the load which produces a combination of stresses resulting in a wheel slightly elliptical; that on descending grades the heat generated by the brake shoe, which is a factor of load, grade and speed, causes a tensile stress in a radial direction in opposition to the compressive stress which was developed while pressing the wheel on the axle, and that the heavy flange thrust causes a bending action in the plate, which intensifies the tensile stress developed by the heat in the front plate and the compressive stress in the back plate developed while pressing on the axle.

The ratio between these stresses developed in the 70-ton car as compared to the 10-ton car is much greater than that indicated by the mere increase in carrying capacity. The heaviest stress developed is probably that caused by the sudden rise in the temperature of the tread of the wheel from brake shoe application on descending grades.

RECOMMENDATIONS

Our association believes that due to the general conditions confronting us today and considering the safety factor of

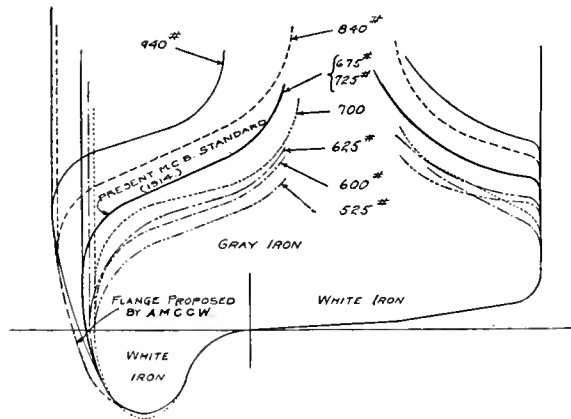

Fig. 2—Development of the Wheel Flange and the Flange Recommended by the Association of Manufacturers of Chilled Car Wheels.

and found to be so satisfactory that cars of lighter capacity ceased to be built for this service. The 700-lb. wheel was used under 50-ton cars and was recommended as standard in 1904 by the M. C. B. Association, but afterwards, upon the recommendation of our association, the weight was raised to 725 lb., and made standard in the year 1909. During the time intervening a new wheel was introduced of the rolled steel type and the steel wheel substituted for the 700-lb. chilled iron wheel weighed a minimum of 750 lb.

Cars of 70-ton capacity have already proven successful from every standpoint and are being made in comparatively large numbers at the present time.

Since the year 1875 the weight of the car structure has increased from 18,000 lb. to as high as 65,000 lb., or 260 per cent increase. The weight of rail has increased from 50 lb. to as high as 125 lb., or 150 per cent. The axle has increased from 350 lb. to 1,070 lb., or 200 per cent. The

operation that three designs of wheels, viz.: 675 lb., 750 lb. and 850 lb. (with 3-16-in. increase in flange) for 30-ton, 50-ton and 70-ton cars, respectively, would, in a great measure, solve our present troubles and our recommendations would be:

- 675 lb. wheel for cars having a maximum gross load of 112,000 lb.
- 750 lb. wheel for cars having a maximum gross load of 161,000 lb.
- 850 lb. wheel for cars having a maximum gross load of 210,000 lb.

COST

The 8,000,000 tons of chilled iron wheels running today possess a higher relative market value when worn out, based upon their first cost, than is usual with other commodities purchased by the railroads. Hundreds of thousands of chilled iron wheels have been sold at a differential of \$10 per ton, which represents the difference between the original selling price and the scrap value of the old worn-out wheels, and this \$10 per ton differential represents the cost of re-converting the old wheel into a new one plus the necessary labor, plus the price of the new material and the profit of the manufacturer. About 30 per cent of all wheels sold are removed by foreign lines and the price paid for these removals is fixed by the printed interchange rules of the Master Car Builders' Association, as follows:

	Chilled Iron	Steel
New value, each.....	\$9.00	\$19.50
Scrap value, each.....	4.75	4.50
Net cost.....	\$4.25	\$15.00
Cost of removing from and replacing in trucks, per pair, \$2.25, each.....	1.12	1.12
Cost under car, each.....	\$5.37	\$16.12
Cost of two turnings.....		3.25
Total cost of wheel service, each.....	\$5.37	\$19.37

It will be observed that the total cost for wheel service for other types of wheels is about four times that of the chilled iron wheel and upon this basis of comparison any substitute must yield four times the mileage or time service in order to equalize the cost.

Chilled iron wheels sold at a differential of \$10 per ton makes the net cost of the three Master Car Builders' standards as follows:

- 625 pounds MCB wheel for 30 ton cars—\$3.12
- 675 pounds MCB wheel for 40 ton cars— 3.37
- 725 pounds MCB wheel for 50 ton cars— 3.62

All chilled iron wheels, unlike other types, are guaranteed for the minimum service. The cost per year with the guarantee is as follows:

- Maximum net cost of 625 lb. MCB wheel guaranteed for 6 years—52 cents per year.
- Maximum net cost of 675 lb. MCB wheel guaranteed for 5 years—67 cents per year.
- Maximum net cost of 725 lb. MCB wheel guaranteed for 4 years—90 cents per year.

Any wheel that is sold for \$20 will cost the railroad, in interest charges alone (figured at 5 per cent per annum), more than the renewal charges of the chilled iron wheel, because while the guaranteed net cost to the railroads is based upon six, five and four years' service, respectively, the actual service is often twice as much. During the last two years the prices of all commodities have reached their highest figures. Nevertheless, the price of the chilled iron car wheel has practically remained constant.

We have not yet reached the capacity of the chilled iron car wheel and to-day we have in service wheels weighing 950 lb., which are 225 lb. heavier than the heaviest M. C. B. standard. These wheels are carrying a burden of 26,500 lb. per wheel and they have given such satisfactory service under engine tenders of 12,000 gal. capacity that no other type of wheel is considered by the user.

INSOLUBLE IMPURITIES IN OIL.—Insoluble impurities in oil can easily be detected (although the nature of them cannot be determined) by mixing a quantity of oil with gasoline so that it will filter through blotting paper. Any such impurities are deposited on the paper, and can be seen.—*Power.*

DERAILMENTS DUE TO DEFECTIVE EQUIPMENT*

BY WILLIAM QUEENAN

Assistant Superintendent Shops, Chicago, Burlington & Quincy, Aurora, Ill.

During a period of 21 months, beginning December 1, 1914, and ending September 1, 1916, one of the western railroads had 350 derailments caused by defective equipment. These derailments had 44 different causes; 189 of them were on equipment owned by the railroad and 161 on foreign equipment. The table shows a list of the causes and the number of derailments from each cause, divided according to the ownership of the cars. The derailments recorded under the last four items in the table, were each the result of a separate cause and have been roughly grouped in four classes.

Defects	Cars		Total
	Owned	Foreign	
Brake beam down.....	35	36	71
Broken wheel.....	21	15	36
Coupler pulled out.....	17	16	33
Broken journal.....	10	17	27
Burst air hose.....	21	5	26
Burnt journal.....	11	12	23
Loose wheel.....	9	11	20
Broken flange.....	16	4	20
Broken arch bar.....	5	5	10
Broken axle.....	4	6	9
Broken oil box bolts.....	4	4	8
Broken truck sides.....	4	3	7
Broken brake rod.....	3	3	6
Sharp Flange.....	3	2	5
Broken brake hanger.....	2	3	5
Broken knuckle.....	5	..	5
Broken truck.....	2	..	2
Brake rod down.....	2	2	4
Draft timbers pulled out.....	..	3	3
Worn knuckle.....	2	..	2
Broken train line.....	1	1	2
Broken equalizer.....	2	..	2
Miscellaneous truck defects.....	5	6	11
Miscellaneous underframe defects.....	1	..	1
Miscellaneous brake rigging defects.....	2	1	3
Miscellaneous coupler defects.....	..	2	2
Total.....	189	161	350

The 71 derailments caused by the dropping of brake beams are a little more than 20 per cent of the total number of derailments recorded. This is entirely too many accidents traceable to one cause. That this particular cause of derailment is not confined to any one railroad, however, is well brought out by the statement contained in the 1915 Proceedings of the Master Car Builders' Association, showing that about 37 per cent of the derailments of one eastern road resulted from this cause.

The most frequent cause of dropped brake beams is the loss of brake hanger pins. These pins are secured in several ways; the most common practice is to use a cotter or split key, or a common nut with a lock nut. No matter which of these fastenings is used, its security depends entirely upon the care with which it is applied. Frequently the nut is not turned up on the bolt sufficiently, or the nut lock is left off entirely, or the cotter key may not be split sufficiently to prevent it from working out of the hole in the pin. What is needed is a device by which the pin becomes automatically locked in place when it is inserted. I believe that such a device can be developed and when it is it will do away with a great many derailments resulting from dropped brake beams.

The accidents from broken or defective wheels and axles emphasize the fact that cars cannot receive too careful inspection. In many railroad yards car inspectors are burdened with other duties, such as taking seal records, opening the doors of box cars and examining the contents, which frequently interfere with their primary duty of inspecting freight cars for mechanical defects. It is much better to employ other help to secure seal records and the many other records which car inspectors are sometimes asked to get, than it is to allow this class of work to interfere with the principal duty of the inspector.

The derailments caused by the pulling out of couplers and

*From a paper read before the Car Foremen's Association of Chicago.

draft timbers are mostly the result of operating old, low capacity cars in heavy trains.

Derailments caused by bursted air hose are difficult to prevent. The ordinary inspection of air hose is not likely to detect hidden defects in the hose. The outer casing of air brake hose checks from different causes; this allows moisture to penetrate to the inner fabric, causing it to decay until it is unable to withstand the pressure and it bursts. A better quality of air brake hose should reduce these derailments.

BOX CAR SIDE DOOR

In a paper on Freight Car Repair Problems presented before the Car Foremen's Association of Chicago by Lewis K. Silcox, mechanical engineer, Illinois Central, the drawings of a box car side door were shown. This door has been applied to several thousand cars and has given excellent service. It is shown with its details, in the illustrations. The body of the door is made up of 13/16-in. matched boards,

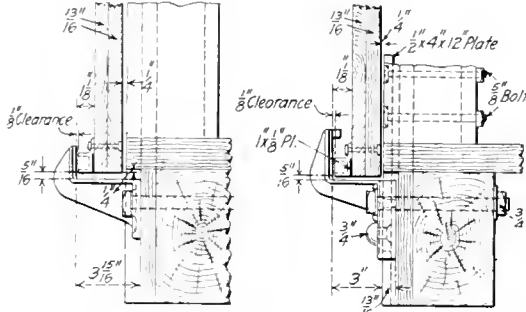

Section Y-Y.

Section Z-Z.



Detail of Iron Plate.

Plate to be Applied to Both Front and Back Door Post. Post to be Framed to Suit.

I	H	G	F	E	D	C	B	A	Class of Car	Car Nos
2'10 1/2"	2'2"	2'8"	12 1/2"	1'4"	2'8 3/4"	2'9 1/2"	5'6"	7'10"	36'-20 1/2 ton	BA33101-35500
										38601-42100
										45001-49700
										47001-47600
										30001-31000
		3'	2'7 1/8"	12 1/4"	13 1/8"			7'8 3/4"		31001-31800
			2'8 1/2"	12 1/2"	14 1/8"			7'10 1/2"		25001-25501
3'1 1/4"	2'2"	2'9 1/2"	13"	14 1/2"	2'11 1/4"	3'0 1/4"	6'0"	9'1 1/2"	40-50 Ton	140001-143000
2'10 1/2"	2'5"	11 1/2"	12 1/2"	2'8 3/4"	2'9 1/4"	5'6"	7'4"	40'-40"		21101-21600
										22101-23097
										33001-33100

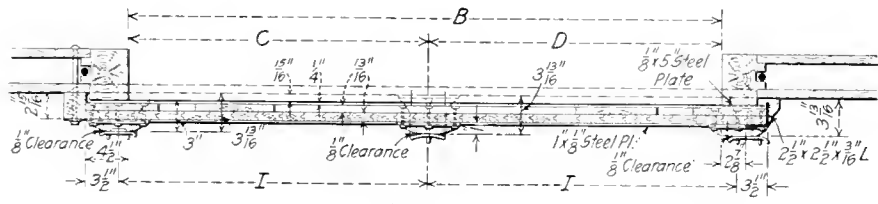

Section X-X.

Details of Box Car Side Door

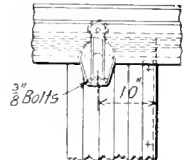

Application of New Door Hanger. These door hangers do not need the 1/8" hanger plates.

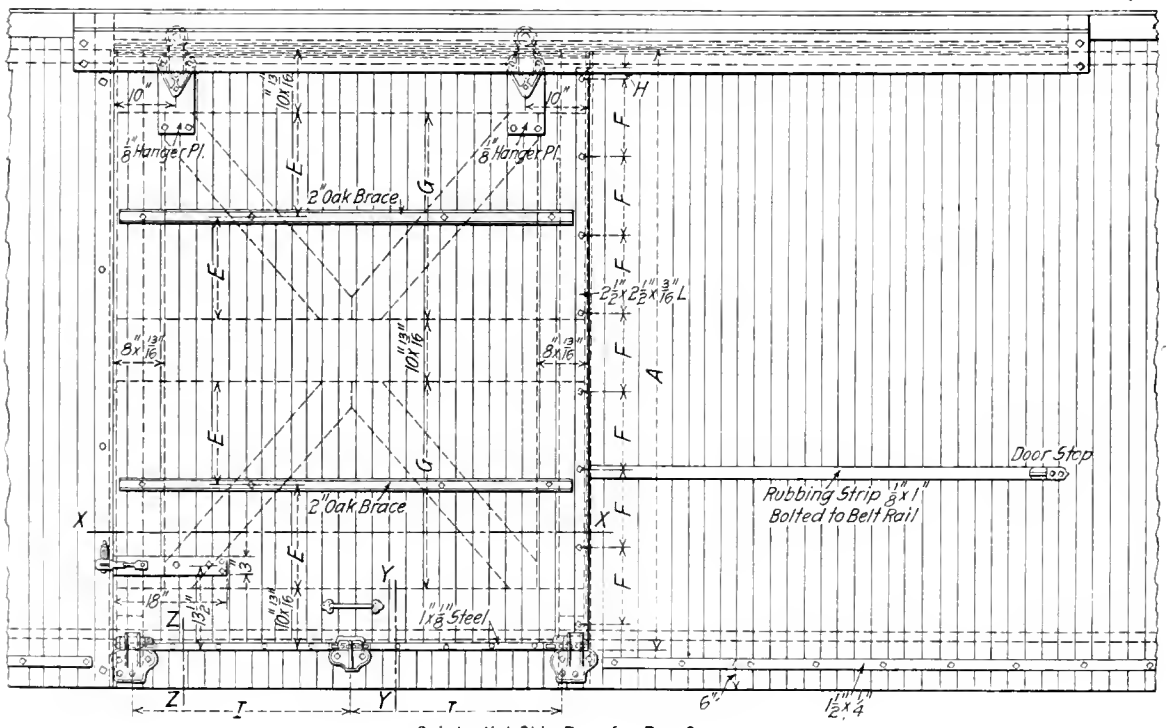

Substantial Side Door for Box Cars

reinforced at the back by 10-in. by 13/16-in. boards at the top, middle and the bottom, and by diagonal braces extending between these members. At both ends there are vertical strips of the same material eight in. wide. On the front, two longitudinal oak braces two in. thick, located as shown in the elevation, give additional stiffness to the door.

A 5-in. by 3/8-in. steel plate is fastened to the back door post for its full length, forming the weather strip. A 2 1/2-in. by 2 1/2-in. by 3/16-in. angle on the back edge of the door overlaps this weather strip when the door is closed. The door is hung on rollers at the top. Three door guides are used to hold the door in place when it is closed. The two end guides are riveted to a 1 1/2-in. by 4-in. by 12-in. plate which is bolted to the side sill and door posts as shown in section Z-Z. With this construction it is impossible to remove the guides from the outside of the car when the door is closed, without cutting the rivets. A strip of steel plate 1 in. by 1/8 in. along the bottom of the door protects the body of the door while it is being opened and closed.

THE CAR DEPARTMENT APPRENTICE*

BY FRANK DEVOT, JR.

Chief Draftsman, New York Central Lines, East Buffalo, N. Y.

From experience with car department apprentices I have found that it is a hard problem to keep up their interest in the work because of the seeming lack of inducements and the laborious work they are called upon to do in repairing freight cars. It has also been difficult to convince a boy that the carpenter's trade could be taught thoroughly in a freight car repair shop. However, first class car men can be obtained through a combined system of training both in the shops and classrooms. The boys should be instructed by expert car men who can exert the proper discipline. They should be trained in all branches of the work at a car shop, especially where new work is done as well as reconstruction work. The boys should be about 18 years old and should have a fair grammar school education. They should be required to pass a suitable examination before being allowed to enter the apprentice course. The length of the course should be three years and the boys should be started in the department where the work is most likely to appeal to them. They can then be advanced into each department as they become qualified.

Problems which constantly arise in the course of shop training should be taught in the classroom and a sufficient amount of car drawing should be taught to enable the apprentice to read a drawing, make such free-hand sketches and perspective drawings as are often found necessary in car work. If the boy is given to understand that he is not there to become only a car repairer, but that he is expected to qualify himself for something better, there will be no trouble in getting a good class of men and keeping them.

There is another obstacle confronting the car department apprentice and that is the wages paid. The time has gone by when you can get a young man of intelligence to work for a meagre salary just because he is learning a trade. This fact has been found to be true by the smaller concerns who employ apprentices at nearly a journeyman's rate to induce the young men to learn the trade in order that they may be developed into foremen and other official positions.

Another way to make apprentice work attractive in the larger shops, and where there is a sufficiently large number of apprentices, is to organize an apprentice club. Quarters can be fitted up in some part of the shops, or close by, where the boys can assemble in the evening and discuss papers on the different classes of work and play games suitable to young men. A baseball club may be organized also and managed by those interested in the apprentice work.

* Entered in the Apprentice Competition of the Chief Interchange Car Inspectors' and Car Foremen's Association and presented at the annual convention, Indianapolis, Ind., October 3, 4 and 5, 1916.

STEEL GONDOLA VERSUS COMPOSITE GONDOLA*

BY WILLIAM QUEENAN

Assistant Superintendent Shops, Chicago, Burlington & Quincy

In the last few years many articles of interest have been written with regard to the steel gondola car. These writings touch on the probable life, cost of repairs, proper care and detail of construction. In a review of the subject it would appear that the gondola of composite type has not received the same consideration given the all steel car.

The Chicago, Burlington & Quincy has over 18,000 all steel gondola cars in service. These cars range in age from two to thirteen years and compare very favorably, as to condition, with those of like construction owned by other roads. They are all 40 ft. 50-ton capacity, drop bottom cars, having from 12 to 16 doors, with an average light weight of 38,800 lb. and are of different designs, seven car companies participating in their manufacture. This road also owns 1,000 composite gondola cars.

COST OF REPAIRS

A record of the cost of repairs to individual classes of freight cars has been in operation upon this road for about two years and some very valuable information obtained.

In the year 1903 the 1,000 composite gondola cars before mentioned were built. These cars are 40 ft. in length, 50-ton capacity, with steel side stakes and underframing, wooden sides, ends, floors and drop bottom doors. The lumber used was 2 1/4 in. and the light weight of one of these cars is 39,700 lb. In the same year 1,000 all steel gondolas were built. These cars are 40 ft. in length, 50-ton capacity, and have drop bottom doors. The side sheets and door plates are 1 1/4 in. thick. The light weight of these cars is 37,800 lb.

During the 12 months ending August 31, 1916, 167 of the composite gondola cars as described were repaired at one of the company's largest shops, at an average cost of \$21.82 per car (truck repairs not included). Of this amount \$2.53 was spent on the draft rigging, \$11.28 on the underframe and \$8.01 on the body of the car.

During the same period 332 of the all steel gondola cars before mentioned were repaired at the same shop, at an average cost of \$29.77 per car (truck repairs not included). Of this amount \$3 was spent on the draft rigging, \$10.18 on the underframe and \$16.59 on the body of the car.

Repairs to the draft rigging include couplers and attachments, draft castings, uncoupling devices, short draft sills or plates, buffer blocks and all other parts of draft gear. Repairs to the underframe include all sills, body bolsters, body center plates, body side bearings, cross bearers, dump doors, and operating mechanism. Repairs to the body cover all parts of it including the floor.

It is the aim of this road to keep its cars well painted and during the period of one year 14 of the composite cars were repainted at one shop at an average cost of \$3.81 per car, and 42 of the before described steel cars were painted at a cost of \$2.83 per car.

Records show that the total repairs on the entire system which includes trucks to the composite gondolas cost as follows per month:

Average per car repaired.....	\$5.25
Average per car in service.....	3.08
Number cars repaired.....	600
Number cars in service.....	999

This compares with cost of repairs to the all steel gondolas before mentioned as follows per month:

Average per car repaired.....	\$6.73
Average per car in service.....	4.80
Number cars repaired.....	710
Number cars in service.....	987

STEEL GONDOLA CARS

In 1911 after eight years of service the drop doors on the steel gondola cars before described had become worn and dis-

* Abstract of a paper presented before the Western Railway Club.

torted considerably and on account of a faulty door operating mechanism the operating mechanism was removed, the door straightened and closed permanently. Four years later, in 1915, these door sheets had rusted to such an extent that they were unsafe, and after going into the matter thoroughly to determine whether new steel doors should be applied or not it was finally decided that new steel doors would outwear the sides and that the economical thing to do was to put in solid wooden floors, which is being done. The wooden floor will give good service for five years.

A year ago the work of reinforcing the doors on steel gondola cars built in 1906 and 1907 was begun. These doors are rusted and worn so badly that a new door plate is required. It is also found that some of the doors are not worth repairing in this manner and new doors must be made complete. The center cover plate and end floor sheets in all of these cars are worn very thin and will soon have to be renewed.

As will be seen, corrosion is the greatest enemy of the steel car. A great deal toward the prevention of outside rust can be accomplished by taking care of the small rust spots when they are first discovered. They should be thoroughly cleaned and painted.

While the outside of the car body may be kept in good condition as regards the rust, it will be found that on all steel cars corrosion on the inside usually starts within a few months after the cars have gone into service, and within two years the inside of the body, floor, drop doors and underframe will show very materially the effects of the rust.

Experiments have been made as to painting and oiling insides of steel gondola cars, but it has been found that this paint or oil is rubbed off so quickly that it does not pay. Good results can be accomplished by sand-blasting of steel cars, but few roads spare the time and outlay of money that this practice requires. Most roads are endeavoring to keep their steel cars well painted, for if the outside corrosion can be stopped the life of the side and end sheets will be prolonged.

It would appear that steel cars operated in low damp regions are more susceptible to corrosion than those used in higher and dryer climates, and cars used in bituminous coal hauling are undoubtedly affected by corrosion more than cars used in hauling anthracite coal. The practice of loading cinders in steel gondolas is very objectionable; when wet the acid in the cinders will attack the steel, and if they are not wet down good before loading they are often so hot that they will burn off the paint.

The practice of unloading coal from gondolas with a clam shell bucket is bad; if the operator is not a careful man a large amount of damage will be done to the floors and sides of the cars. The practice of loading freight car trucks in gondola cars with drop doors in bottom is bad and does a large amount of damage.

COMPOSITE GONDOLA CARS

The composite gondola cars built in 1903 before mentioned and described are still in very fair condition. A large portion of the original lumber is still in them. Repairs outside of that to the draft gear and trucks consist principally of renewals of the end and drop door planking. Floors in some places also need attention. The steel parts where they are protected by the wood-work are in good condition. These cars have given very good service.

Owing to the small number of composite cars as compared with the large number of all steel cars, the writer will not try to say which of the two types are the best, but rather try and point out some of the good points of both types.

CONCLUSIONS—IN FAVOR OF THE ALL STEEL CAR

Some of the repairs to all steel cars can be made without removing the defective parts from the car.

Outside of extensive damage, defective parts can be straightened and used again, thus reducing material cost.

If the floor and drop door sheets, cover plate and the bot-

tom of the side sheets where they are riveted to an angle were reinforced or made of heavier steel than the main portion of the side and end sheets, the cost of repairs would be reduced, and the life of these parts lengthened so that they would last as long as the side and end sheets.

The salvage value of the all steel car is much greater than the composite type of car.

For the first three or four years the cost of repairs, barring accidents, to the all steel cars is very light.

CONCLUSIONS—IN FAVOR OF THE COMPOSITE CAR

The initial cost of the composite gondola with the present price of steel should be less than the all-steel gondola.

The composite type of car costs less to maintain than the steel gondola.

The sides of the composite car do not bulge as do those of the steel car.

Records show that while the composite car costs more to repaint than the steel car, it does not require painting as frequently.

A large portion of the repairs to composite cars can be taken care of at other than steel car shops.

Certain properties in coal cause corrosion to steel but do not affect the wood.

INTEREST THE MEN IN HOT BOXES*

BY G. S. TAYLOR

General Foreman, Atlantic Coast Line, Wilmington, N. C.

Some time ago we were annoyed considerably with hot boxes. In each case the inspectors stated that the "boxes appeared to be in good condition leaving the terminal." I found, by personally following them up, that such was the case. I noticed also that cars would get quite a distance from the terminal before the trouble developed. I finally came to the conclusion that the difficulty was of a very small nature, to overcome which it would be necessary to examine and repack all of the boxes before leaving the terminal. This would have proved most expensive and could not be done with the forces on hand.

We have very few through cars at the terminal, as all of the business either originates there or is for export. Cars come into the terminal and are placed at the export wharves or at some industry and probably stay in the yard for several days. Of course, the inspectors examine all boxes when the cars start out. The adoption of the following plan reduced our hot-boxes practically more than 50 per cent:

The inspectors are instructed to go over a train on its arrival and feel the boxes; if they are the least bit warm they mark them with a piece of blue chalk. Nobody is authorized to rub this chalk mark off except the car oiler, and when trains are made up to go out the car oiler goes over them. If a box lid is marked with blue chalk, his instructions are to examine the brass and pack the box. Quite frequently he finds a hard spot in the brass or the packing is dry; the boxes from a casual observation or inspection, however, would appear to be in good condition. Under the former practice the inspector would raise the box lid and if the packing and brass appeared to be in good condition he would only stir the packing up, getting the saturated dope in the bottom of the box up next to the journal. Under the new method, when he sees the blue chalk mark he knows the box came in a little warm, indicating that there was some hidden trouble which must be remedied. After giving attention to the box he rubs the blue chalk marks off. This method, as before stated, has reduced our hot boxes about 50 per cent.

I followed up personally the attention that inspectors and car oilers were giving boxes and got them enthused with the handling of this matter, showing them the saving that we would effect by the proper and economical use of oil, as well

*Entered in the Hot Box Competition.

as how expensive it is in the locomotive fuel consumption and delays to have to stop trains to pack boxes.

It has been my experience that the best method to get results is to work with the men who are actually doing the work, instead of driving them; show them that the dollars saved by them for the company will finally revert back to them in increased wages and better working conditions. Or in other words, work up a better interest in the company's business by trying to teach them that they are just as much a part of the company as the foremen.

CO-OPERATION BETWEEN YARD AND CAR REPAIR FORCES*

BY R. H. DYER
Norfolk & Western

Co-operation between the yard and car repair forces is essential for the promotion of business, as well as the economical handling of terminal yards. Freight will be delayed and cars await repairs, attended by much loss of time and efficiency, when the two forces fail to work in harmony with each other. While the car repair forces by holding up cars for repairs may interfere with routine terminal movement of the trains, they are as much interested in the prevention of delays and keeping the number of bad order cars down to the lowest possible figure as the operating department.

The trouble, work and anxiety of a car repair force really begins with the appearance of defective equipment. Many times, to their sorrow, they see the fruits of their labor terribly abused, and their days of labor and the expense for which they are responsible and must account for, torn asunder in one shifting movement by a yard crew. Unfortunately it is often felt by some repair forces that such destruction is attended by indifference on the part of those in charge of the yard.

There may be, and undoubtedly is, an economical speed at which the cars should be shifted, time and damage to the equipment considered, and the humble car repairers who witness the damage and are required to explain why there are so many bad order cars and why there is an increase in the cost of maintenance, are not uninterested parties. In the days of the link and pin coupler the train crews instinctively regulated the movement of the cars and made couplings at moderate speeds not solely for their convenience but for their personal safety as well. Equipment under such treatment receives the least abuse, but since the introduction of the automatic coupler which permits more severe practices without danger of personal injury there seems to be a lack of interest in the preservation of equipment. Personal safety that accompanies the introduction and development of the automatic coupler, application of air brakes, etc., is having its reward. Still the number of injuries which are the result of carelessness and the unnecessary taking of chances is appalling. It matters not from the shopman's point of view whether the cars are destroyed by jerking or buffing, although the latter is the more serious. The thought naturally arises that greater team work could be obtained if the yard forces could be made to appreciate the losses from the rough handling of equipment.

In the interest of co-operation the yard forces and inspectors should, in the handling of loaded cars requiring transfer, decide as soon as possible what cars are to be so handled in order that the yard forces may move the car direct to the transfer track, and avoid any delay incident to a shift to the repair track for further inspection. The yard forces should work, in such cases, in harmony with the repair men and expect as much in return. Ordinarily, the open hand

must first come from the yard people with their assurance of support and co-operation, and they should also encourage a free exchange of views for the common efficiency. When car foremen select cars for certain classes of lading they should endeavor to give the yard people as little switching to do as possible.

The handling of box cars at terminals where such equipment is extensively used is a most important matter, and one offering many opportunities for the exercise of good judgment. Inasmuch as it is generally the rule that these cars are not kept up to a high standard of physical condition, the yard people are confronted with a task of handling cars to the best advantage, disposing of them at the least cost and loss of mileage. Hence cars not serviceable for the highest class of freight must be utilized as the conditions permit. This includes the disposition of the foreign box car equipment having more or less defective superstructure and where a prohibitive length of time will be required to get repair material from the home road.

The yardmasters can be of great assistance to their repair forces by giving them advance information concerning the cars desired for delivery. Ordinarily the inspectors do not know what is in contemplation until the work arrives. As a result the cars will have to be inspected and repaired hurriedly and in many cases the train will be delayed. The handling of perishable freight and livestock is also of importance. Yard forces usually obtain due notice of such shipments, but very often the information is slowly handled, or not given to the repair forces at all. Hence they are left in more or less ignorance until the cars are discovered in the yards. Under such circumstances delays, often more or less serious, occur, whereas, if a little information had been given this might have been prevented.

The car foremen should require the car inspectors and repair men to furnish prompt information to the yard forces regarding the cars that should be shopped out of a train, giving them the initials and the numbers of the cars in order to assist the crews in switching them. In the larger yards where bad order cars are classified on special tracks, much has been accomplished by the inspectors indicating the light and heavy repairs by attaching a small red or white card to the side of the cars. This enables the switching crews to tell at a glance, and at some distance, where the shop cars are located and also where they should be placed so that the repairs may be made to the best advantage and with the least loss of time. The yard forces should be told of and be made to appreciate the importance of properly classifying the bad order cars on the shop tracks. These tracks should be laid out with respect to the classification yard, for the convenience of all concerned.

There is always some advantage to be gained in keeping repair organizations together, so that the material and facilities may be close at hand and not spread all over the property. At the same time car repair foremen will generally prefer to separate the car repair yards in preference to increasing the amount of shifting to be done to the bad order cars, unless possibly the shifting engine is under the car repair foreman's charge, in which case the work is always handled to the best advantage and with greater care. When cars are once damaged, particularly the draft gear, end or center sills, additional handling means that they are often subjected to further serious damage. It is believed by some car men that the shifting question is probably responsible for three-fourths of the damage, and many car repair forces which are given the opportunity to express their views on the layout of yards will, in a general way, advocate carrying the material to the point or place in the yards where bad order cars naturally assemble, or where they are taken out of the trains, as against depending on shifting the cars any distance to reach the common yard.

Another matter which should be given the most careful

* From a paper read before the annual convention of the Chief Interchange Car Inspectors' and Car Foremen's Association, Indianapolis, Ind., October 3, 4 and 5, 1916.

consideration by both the yard and car repair forces is the blue flag. The yard forces, both mechanical and transportation, should hold the blue flag in the highest respect and keep in mind that it is put on a car or a string of cars not to handicap operation but to protect the life of the employees. Again the car forces should remember that repairs should be made as quickly as possible and never allow the flag to remain longer than is absolutely necessary to protect themselves.

It is evident that the car repair force is an important factor in the transportation problem as through its efforts it is possible to keep the equipment moving with safety. At the same time it is only by the closest co-operation between the yard and the repair forces that it is possible economically to handle the movement with despatch. If co-operation does not exist to the highest degree and the car repair forces are not given the best opportunities for doing their work, the work can only be done at a greatly increased cost and with possibly a serious delay to the traffic. Good yard management should regard the car repair forces as truly assistants and offer them every means quickly to repair and return to service equipment taken out of the trains. While the car repair work may appear to be a necessary evil it is one of the normal conditions in rail-roading and it should be recognized that any delay to the rapid execution of the repairs to cars is expensive in many directions, viz.: in the cost of repairs itself, in the delay to the cars, in the value of the car, in the loss of revenue and, last but not least, in that it may cause embarrassment to the shippers. So important is this question of co-operation between the yard and repair forces that the general offices should assist in its encouragement to the greatest degree.

RECENTERING CAR AXLES

BY E. A. M.

It is difficult and expensive to recenter a car axle on a lathe, especially where a large number have to be recentered. With the device shown in the illustration this can be done at a small cost. It consists of an old man made from 1-in. by 2½-in. material, twisted as shown to form a back rest for a small air motor. One end of the old man is clamped to the

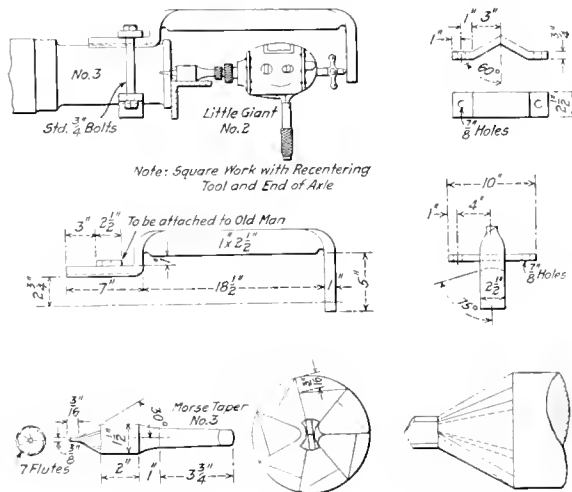

Arrangement for Recentering Car Axles

journal of the axle by two ¾-in. bolts. The surface of the old man on this end is slightly rounded to prevent it from sliding. The bottom of the clamp is made from a piece of 2½-in. by ¾-in. material. The construction of the drill used for this purpose, has a point 3/8 in. in diameter and 3-16 in. long with a fluted bevel for countersinking the holes.

The body of the drill is 1½ in. in diameter and the shank is provided with a No. 3 Morse taper. The drill is squared as indicated in the illustration by squaring the body of the drill with the face of the axle. The feed screw is then set on the back rest of the old man. This tool has been found entirely satisfactory and saves a lot of time in recentering the axles.

INTERCHANGE INSPECTION PROBLEMS*

BY W. H. SAGSTETTER

Master Mechanic, Kansas City Southern, Shreveport, La.

To study and interpret properly the M. C. B. rules, as improved each successive year to meet the changed conditions, is the paramount duty and ambition of this organization. The present day inspector must have a good education and must be in a position not only to read, but to memorize the rules, whether they be the interchange rules, loading rules, safety appliance regulations, or special instructions issued by the company for which he is working. He must protect his company when cars are interchanged. He must be unbiased and conservative. He must be able to judge as to when a car is in safe condition to proceed, and he must expedite the movement of cars as consistently as possible. The work of this organization has been such that these men are able to determine difficult cases more quickly, clearly and accurately.

It lies within the power of the association to expedite the movement towards a systematic interchange of cars which will result in a tremendous saving. The proper step in this direction is, I believe, the establishment of joint interchange and inspection bureaus at every point where two roads interchange cars. Where there is a chance of difference of opinion, one man should handle the interchange, if possible to do so. If this is done it will be one of the greatest factors in the better movement of both loaded and empty cars.

Another subject that should receive consideration is the rules governing the transfer of loads. There is much unnecessary transferring done, sometimes through ignorance and sometimes through fear, and a great deal through the spirit of reciprocity. The latter condition usually prevails at points where more than one inspector is located. One inspector feels that a certain car has been transferred on technicalities, and he compels a transfer on technicalities to get even. In both cases the railroads hold the sack and pay the money. One of the principal causes for transfer of loads is elongated holes in draft sills. Why not recommend that the holes be worn 2 in. or 2½ in. before transfer authority be given?

Another matter that needs consideration is the technical carding of cars. This is brought very forcefully and frequently to our attention on carding for raked siding. Why not recommend that before a card be given for raked siding it must be raked into the tongue and groove of the siding and that the roofing raked on the ends must be split inside the fascia board before a defect card is given. We must depend upon such an organization as this eventually to work out the undesirable features that are found in connection with the interchange of cars today.

HUMAN ELEMENT IN ACCIDENT PREVENTION.—Railroad and industrial statistics indicate that only about 10 per cent of all accidents to employees are of a character which mechanical safety devices, or the previous correction of unsafe conditions, will prevent. The other 90 per cent are largely of a character which can only be prevented by the exercise of greater care on the part of the human beings involved in the accidents. Therefore, the principal avenue in which our accident prevention effort must be directed is in the education and supervision of the human forces.—*Marcus A. Dow before the New York Railroad Club.*

* From a paper read before the annual convention of the Chief Interchange Car Inspectors' and Car Foremen's Association, Indianapolis, Ind., October 3, 4 and 5, 1916.

Shop Practice

SHOE AND WEDGE JOB

BY ARTHUR J. HUMPHREY

New shoes and wedges are usually planed in large quantities at a time; they are planed all over except the face and placed in stock until needed. The face is planed to the required thickness as the shoes are needed. Fig. 1 shows a method of planing new shoes and wedges. A long casting is bolted in the center of the table, and the shoes and wedges are clamped on both sides. Both planer heads are used.

The shoes are first clamped with one side up and planed. They are then turned over and the other side of the shoes

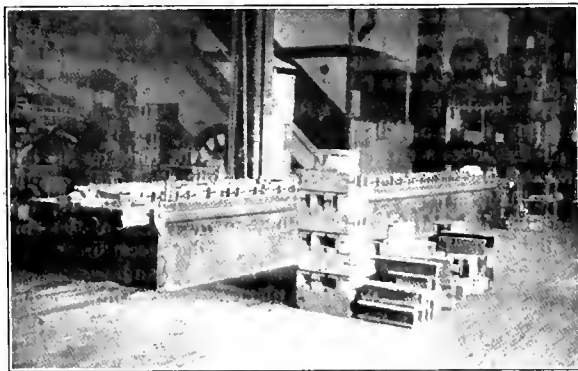

Fig. 1—A Long Table Planer is Used for Planing Shoes and Wedges

is finished $1/32$ in. narrower than the driving box channel within which they go. They are then clamped face down and a roughing cut is taken over the bottom. Two roughing tools may be used for doing this work, clamping them in the tool block about half as far apart as the inside width of the shoe; they are fed down to depth, then fed across.

After the bottom has been roughed out, both sides are planed complete and the bottom is finished in one cut with a wide forming tool. A fine feed is used in taking the cut. Fig. 2 shows the wide forming tool. It should be made $1/32$ in. wider than the pedestal jaws over which the shoes are to fit. This illustration also shows the method of clamping the shoes with tool steel pins and cupped set-screws.

The wedges are planed in the same manner as the shoes, except that when the bottom is planed a block is placed under the thin edge of each wedge and adjusted till the inside face of the wedge is level with the planer table.

The next operation on the shoes and wedges is to lay them out and plane them so that when they are properly set up on the engine, the driving axles will not only be square with the engine but the distances between axle centers will be the same as the length of the side-rods.

There are several methods of laying out the shoes and wedges. The practice in some shops is to run a line through the center of one or both cylinders and to lay off the shoes and wedges in such a manner that the axle will be square with the line. Another method is to square the axle with one or both frames or with an imaginary line drawn central between

the frames. Of course, if the bore of both cylinders are parallel with each other, and with both frames (as they should be) it would be immaterial which method was used. A line square with one cylinder or frame would be square with them all. If the cylinders and frames are not parallel, the shoes and wedges can only be laid out square with one of them. I prefer the method of laying them out so that the axles will be square with an imaginary line central between the frames, and will describe that method.

The binders should be bolted up, and the shoes and wedges should be put in place and held there by a light jack *A*, Fig. 3. In the two main jaws of the engine place the jacks just below the center of the wedge and equally distant from the top of the frame. The wedges should be raised $1/4$ in. above the binders by placing under them a piece of iron $1/4$ in. thick.

Chalk or paint the frames and the shoes and wedges where lines are to be drawn in order that the lines may be seen easily. Then scribe four lines across the front main pedestal jaws, both inside and outside, equi-distant from the top of the frame, and about midway the length of the wedge. This line is shown at *B* in Fig. 3. Place a prick-punch

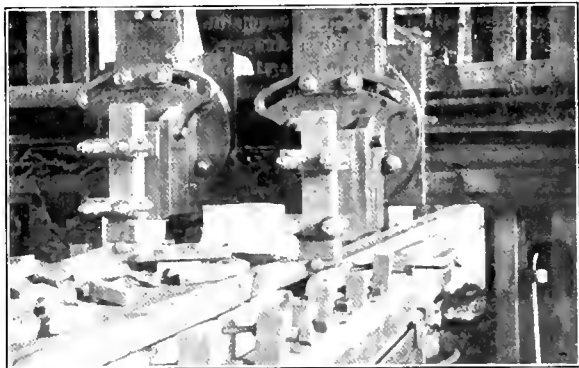

Fig. 2—Method of Planing the Inside of Shoes and Wedges

mark midway between the frames on the cylinder castings; or if it is impossible to tram back from the cylinders to the main jaws, place the mark on a frame brace, or a piece of wood wedged between the frames. Place one end of a tram in this prick-punch mark, and with the other end of the tram (this end should be bent at right angles with the tram), scribe lines intersecting the lines *B* on the inside of the front main jaws far enough ahead to clear the flange of the shoes. Prick-punch the intersection. Place a straight edge *C* across the face of the shoes and with a pair of hermaphrodite calipers adjust the straight edge till it is equally distant from the prick-punch marks on the inside of the front main jaws.

With one leg of the hermaphrodite calipers against the straight edge, scribe this same dimension on the outside of each front main jaw intersecting the line *B* at *D* and prick-punch the intersection.

Scribe a line *E F* on the engine frames above the jaws, and parallel with the top of the frames. Then scribe the

line *GH* through the prick-punch mark *D* the full length of the jaw and perpendicular to the line *EF*. To draw this line perpendicular to *EF*, take a pair of short trams set to a distance greater than from *D* to the line *EF*, and with *D* as a center, scribe arcs crossing the line *EF*. With the dividers, find a point on the line *EF* midway between these arcs, and draw the perpendicular line through this point and *D*.

After doing this on both sides of the engine, find the center of the main pedestal jaws. As the main-rods are (or at least should be) kept to standard length, a very good method of locating the main jaw centers would be to make the jaw centers a standard distance from the face of the

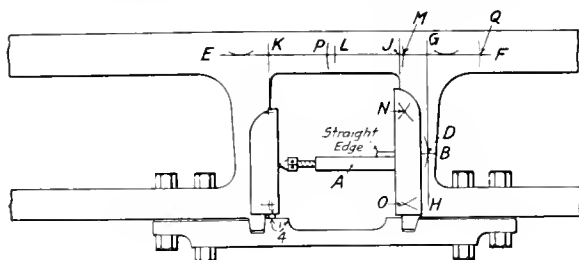

Fig. 3

cylinders. However, if the jaws have not become worn enough to require much filing or milling, scribe a line across *EF* true with the face of the front jaw, and from the point *J*, its intersection with the line *EF*, lay off on the line *EF*, a distance equal to one-half the standard width of the driving box, plus the standard thickness of the shoe. Prick-punch this center, which is *L*.

Another method to be used when the jaws are worn, is to locate the jaw centers midway between the points *J* and *K*. The point *K* is obtained by scribing perpendicular to the line *EF* from a point on the face of the back jaw three inches from the top of the jaw. Whichever method is

center, and with the trams set any convenient distance scribe two arcs intersecting the line *EF* at *P* and *Q*. Then with *P* and *Q* as centers scribe intersecting arcs on the shoe near each end and lightly prick-punch the intersection of the arcs.

Set the dividers from either *N* or *O* to the line *GH*, and using as a center the prick-punch first made on the inside of the front jaw, lay off this dimension on the inside of the shoe, and lightly prick-punch. The shoe is now laid off, and it should be planed to within 1 in. of these marks, a gage being used to test the work after planing. After the finish cut has been taken, the point of the gage should enter the prick-punch mark without crowding.

The shoes on the other jaws may be laid off by tramping from the main jaw centers on each side of the engine, with the trams set to the length of the side rods and proceeding as with laying out the main shoes. If the firebox or some other obstruction prevents doing this, tram from a center located in the jaws. The most accurate method of laying off the wedges is to tram across from the shoe in three places with a tram set to the width of the driving box plus two inches.

In the above discussion it has been assumed that the shoes and wedges were new, and that the driving boxes were all bored central with the shoe and wedge bearing faces. This is not always the case. If old shoes and wedges are to be laid off and it is found there will not be stock enough to true up the face when they are planed, it will be necessary to rivet liners on the inside of them before laying them out. These should be riveted with five rivets, two on each end and one in the middle.

If the boxes are not bored central, scribe lines on the hub face of the driving box with a driving-box gage, in the same plane as the shoe and the wedge bearing surfaces, then find the distance from these lines to the center of the bore of the box and lay out the shoes and wedges accordingly.

The usual method is to plane the shoes and wedges one at a time in a shaper or small planer. Fig. 4 shows a shoe held in the fixture made for planing it. After the finish cut has been taken the corners are rounded with a radius tool, and they are then complete and ready for the engine.

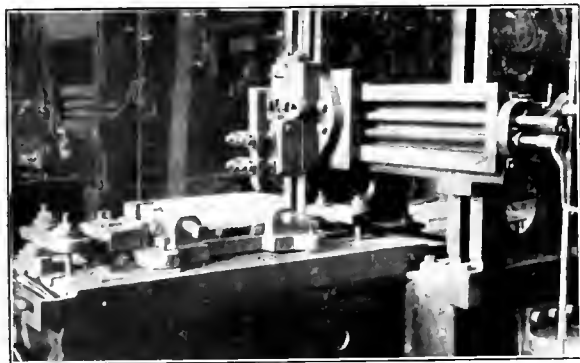

Fig. 4—Finishing the Face of a Shoe

used to get the main jaw centers they both should be equally distant from the line *GH*; if they are not, make them so by bringing the jaw centers nearer the line *GH* on one side of the engine and farther away on the other.

If the driving boxes have been bored central with the shoe and wedge faces (and they usually are), caliper the box, set the dividers to one-half the distance between the shoe and the wedge faces of the box, plus one inch, and with *L* as a center lay off this dimension on the line *EF*. Prick-punch this intersection *M*, then on the outside face of the shoe, locate a point near each end of the shoe; these two points *N* and *O*, should be in a line drawn square with the line *EF* at *M*. To locate these two points use *M* as a

REDUCING WEAR IN DRIVING BOX CELLAR BOLT HOLES

BY H. C. SPICER

The holes in driving box cellar bolt lugs are always subjected to considerable wear and usually wear so rapidly that the lugs must either be replaced, or the holes filled in several times during the life of the box. This is caused by the weight of the cellar together with the constant vibration to which the bearing of the cellar bolts in the driving box lugs is subjected.

A method of supporting the cellar, which relieves the bolts

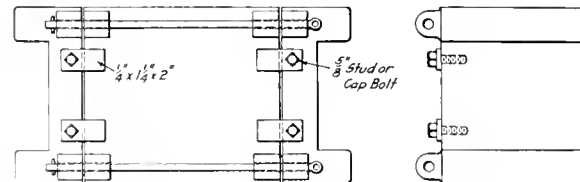

Suggested Method of Eliminating Wear in Driving Box Cellar Bolt Holes

of the weight is shown in the drawing. This is suggested as a means of eliminating the excessive wear. The cellar supports are attached to the bottom of the driving box by means of cap screws. They merely support the weight of the cellar and it is held in place in the box in the usual manner.

BOILER PATCHES FOR LOCOMOTIVES

Strength of the Diagonal Seam Compared With the Longitudinal Seam, Typical Patches Illustrated

BY M. J. CAIRNS

AN article appeared in the July, 1897, issue of "The Locomotive," which is published by the Hartford

Steam Boiler Inspection and Insurance Company, that covered broadly the diagonal joint winding spirally around the boiler, and attention was called to the adaptability of diagonal seams in patch work. As diamond patches, or patches with diagonal seams, are being universally applied instead of duplicating longitudinal seams, which would in most cases require welt strips, and as various methods are used in their computations, the following being an extract from the above mentioned article, is offered for consideration:

"As the strain on a longitudinal seam acts in a girthwise direction, while that on a circumferential seam acts in a lengthwise direction, usually considered as equal to one-half of the strain acting in a girthwise direction, it is apparent that a seam falling between these two seams is subjected to a strain compounded of the girthwise and lengthwise pull."

Referring to Fig. 1, let P be the pull exerted circumferentially upon a section of the shell one inch long. Then

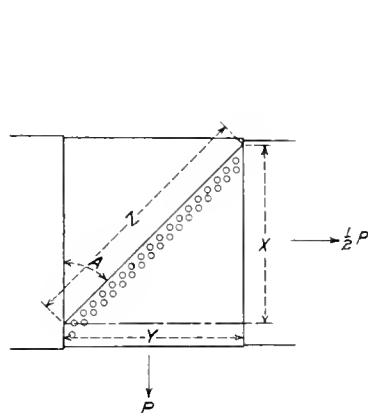

Fig. 1.

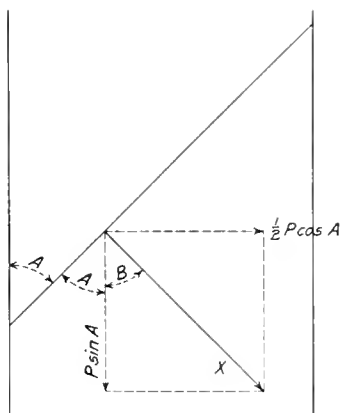

Fig. 2.

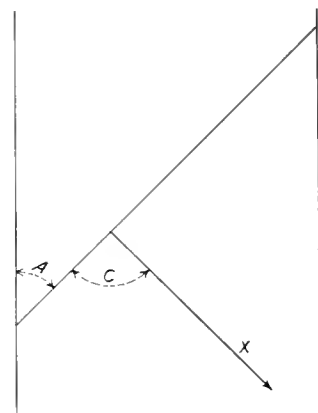

Fig. 3.

$\frac{1}{2} P$ will be the pull exerted upon an equal length of the girth joints. The total strain on the joint Z is made up of the total horizontal pull on the length X , and the total vertical pull on the length Y . The stresses acting on Z may, therefore, be summed up as follows:

First:—A horizontal pull equal to $\frac{1}{2} PX$, and

Second:—A vertical pull equal to PY .

These stresses act along the whole length of Z ; so to find the stress per unit length of the diagonal joint, divide them both by Z . Hence the horizontal and vertical stresses, on

each unit length of Z , are $\frac{PX}{2Z}$ and $\frac{PY}{Z}$, respectively. From the geometry of the figure $\frac{X}{Z} = \cos A$, and $\frac{Y}{Z} = \sin A$.

If these substitutions are made, each unit length of the diagonal joint is subjected to the following forces:

First:—A horizontal stress of $\frac{1}{2} P \cos A$, and

Second:—A vertical stress of $P \sin A$.

This is indicated in the diagram shown in Fig. 2.

Having found how the actual stresses are disposed, several problems present themselves. In the first place, it would be well to know the direction in which the resultant stress X acts. For obtaining this, the diagram, Fig. 2, furnishes:

$$\tan B = \left(\frac{1}{2} P \cos A\right) \div (P \sin A) = \frac{1}{2} \cotan A.$$

If B be found from this equation, then $(A + B)$ is the angle that the resultant force X makes with the diagonal joint. For example, if $A = 60$ deg., $\cotan A = 0.57735$. Therefore, $\tan B = 0.28867$, and $B = 16$ deg. 6 min. Hence: $(A + B) = 60$ deg. + 16 deg. 6 min. = 76 deg. 6 min., which is the angle the resultant force acting on the diagonal joint makes with the direction of the joint.

Another problem is to find the force that acts perpendicularly to the direction of the joint—the "normal force," as it may be called. To solve this problem, take the sum of the normal components of the two main forces. The normal component of the horizontal force is found by multiplying that force by $\cos A$; and the normal component of the vertical force is found by multiplying it by $\sin A$. Perform-

ing these multiplications and adding the results, the total force that is acting upon each unit length of the joint, and at right angles to it, is found to be:

$$\frac{1}{2} P \cos^2 A + P \sin^2 A = \frac{P}{2} (\cos^2 A + 2 \sin^2 A).$$

by a trigonometrical transformation this becomes reduced to:

$$\frac{1}{2} P (1 + \sin^2 A),$$

which is the desired expression for that part of the stress which acts perpendicularly to the joint.

In a similar way the component acting parallel to the joint may be found by multiplying by $\sin A$ where we multiplied by $\cos A$ before, and by $\cos A$ where we used $\sin A$. It will not be necessary to give the details of the operation. The result is, that the force acting on the joint parallel to its own direction is:

$$\frac{1}{4} P \sin 2A,$$

upon each unit length of the joint.

Finally, the total stress X , which comes upon each unit length of the joint, is to be found. This is made up of the perpendicular and parallel stresses, which have already

been derived, and it acts more or less obliquely—in fact, it has already been found that its direction makes an angle of 76 deg. 6 min. with the joint, in the special case in which the joint makes an angle of 60 deg. with the girth seams. The easiest way to find the total stress X is by adding the squares of the two forces indicated by dotted lines in Fig. 2, and then extracting the square root of the sum. This gives:

$$X = \sqrt{1 + P^2 \cos^2 A + P^2 \sin^2 A} = \frac{1}{2} P \sqrt{1 + \cos^2 A + 4 \sin^2 A}$$

TABLE I—FORCE RATIOS FOR DIAGONAL SEAMS

Angle (A) between diagonal joint and girth joint (degrees)	Ratio of force on diagonal seam to that on longitudinal seam	Angle (C) in Fig. 3 (deg. and min.)	Component Force Ratios	
			Perpendicular to joint	Parallel to joint
(1)	(2)	(3)	(4)	(5)
30	0.662	70 34	0.625	0.216
35	0.705	70 32	0.664	0.235
40	0.748	70 47	0.707	0.246
45	0.790	71 34	0.750	0.250
54	0.830	72 46	0.793	0.246
55	0.868	74 18	0.836	0.235
60	0.902	76 06	0.875	0.216
65	0.936	78 07	0.911	0.192

This may be simplified by noting that $\cos^2 A = 1 - \sin^2 A$. Substituting this in the foregoing equation:

$$X = \frac{1}{2} P \sqrt{1 + 3 \sin^2 A}$$

which is the desired expression for the total stress acting upon each unit length of the joint.

These various forces have been calculated by the formulas given above, and are presented in Table I for reference. The unit of force in each case is the force acting upon an imaginary longitudinal joint of the boiler. For example, in a diagonal joint which makes an angle of 35 deg. with the

The only remaining problem is to find how the effective strength of a diagonal joint compares with the effective strength of a similar longitudinal joint. Now there is some slight question about how this ought to be done. The strains on the two joints can be compared directly, but the difficulty is to decide whether it would be fairer to count the total force upon the diagonal joint, or only that part of it which acts perpendicularly to the edge of the sheets. The strains are distributed differently from the distribution which holds in ordinary joints, because the force given in the last column is peculiar to the diagonal joint, and does not occur at all in the common forms of joint that are met with in every-day practice. This new force certainly ought to receive some consideration, because it brings a shearing stress on the rivets, although it does not sensibly affect the tensile

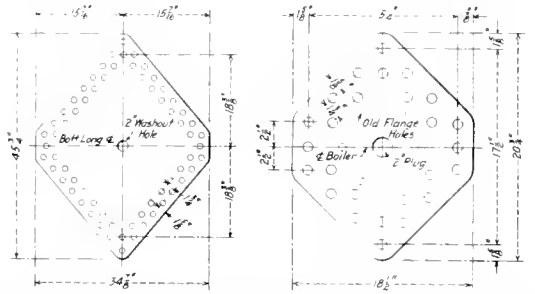

Fig. 6—Patch on Bottom of First Course Fig. 7—Patch on Bottom of Smoke Box

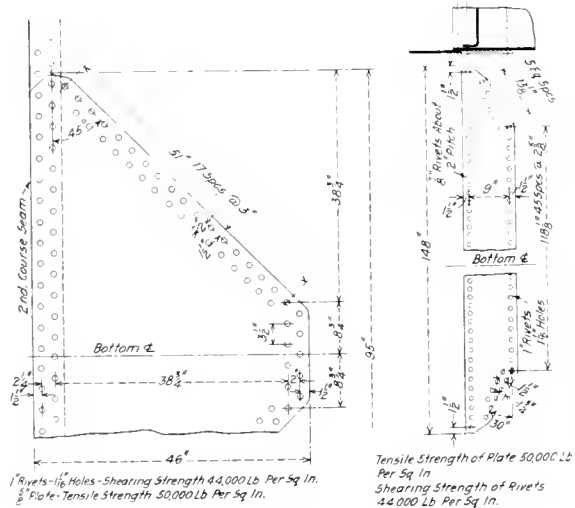

Fig. 4—Patch on Outside of Third Course

Fig. 5—Patch on Smoke Box

girth joints, the total force acting on a unit length of the actual diagonal joint would be .705 of the force that would be exerted upon a similarly designed longitudinal joint in the same boiler; the force acting perpendicularly to this diagonal joint would be .664 times the force that would be exerted upon a similarly designed longitudinal joint; and the force tending to make the two plates slip in the direction of the length of the joint would be .235 of the total pull that would be exerted girthwise (or perpendicularly) upon a similar longitudinal joint.

strain on the net section of the plate. We shall, therefore, base the estimated effective strength of the joint upon the total stress, as given in the second column of the table; and we shall take the relative effective strengths of a diagonal and a longitudinal joint, as inversely proportional to the total stress to which each is exposed in the boiler.

Now the second column of Table I gives the stress on the diagonal joint as compared with that on a similar longitudinal joint: and hence the effective strength of a longi-

TABLE II—FACTORS FOR COMPUTING DIAGONAL JOINTS

Angle A (deg.)	Factor	Angle A (deg.)	Factor
0	1.51	50	1.06
35	1.42	55	1.15
40	1.34	60	1.11
45	1.27	65	1.08

tudinal joint could be found at once by multiplying the strength of the corresponding diagonal joint by the proper number in the table. But this is not precisely what is wanted to be done. The problem should be worked the "other end to"; and hence the effective strength of the diagonal joint is found by dividing the strength of the longitudinal one by the proper number in column 2. Thus in the particular case of a diagonal joint whose angle is 45 deg.: the effective strength of such a joint is found by dividing the strength of the corresponding longitudinal joint by .790; or (which is the same thing) by multiplying it by $1 \div .790 = 1.27$. It will be seen that 1.27 is the multiplier given for this case in Table II: and the other multipliers in that table are all found from the corresponding numbers in the second column of Table I in precisely the same way.

Table II contains the factors referred to in the foregoing paragraph, and the following rule is used with it:—

"To find the effective efficiency of a diagonal joint, first

find the efficiency in the usual way, as though the joint were of the ordinary longitudinal type. Then measure the angle *A* in Fig. 1, the angle the diagonal joint makes with the girth joint, and find the factor opposite this angle in the table. Finally, multiply the efficiency as found above by the tabular factor, and the result is the effective efficiency of the diagonal joint."

Example:—Consider a boiler carrying 170 lb. pressure, and having 66 in. inside diameter shell, to which is applied the patch shown in Fig. 4. Figuring the diagonal seam as being in a longitudinal position, the strain on it would equal

$$170 \times 33 \times 51 = 286,110 \text{ lb.}$$

Multiplying this by .79 from column 2 in Table I, we have

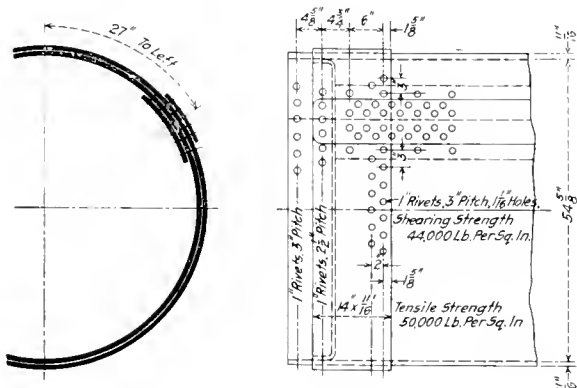

Fig. 8—Patch Around First Course Made on Account of Pitting Around the Tube Sheet

$286,110 \times .79 = 226,027 \text{ lb.}$ acting on the patch seams. The net section of the plate equals:

$$51 - (17 \times 1.5) \text{ sq. in.} = 20.6 \text{ sq. in.}$$

This gives a stress of: $226,027 \div 20.6 = 10,972 \text{ lb.}$

The area of the rivets is equal to: $33 \times 0.7854 = 25.9 \text{ sq. in.}$ This gives a shear on rivets equal to $226,027 \div 25.9 = 8,726 \text{ lb.}$

Likewise the efficiency may be found with the assistance of Table II as follows:

$$\text{Efficiency of plate} = \frac{P-D}{P} = \frac{3-1.06}{3} = .646 \times 1.27 = 82 \text{ per cent.}$$

$$\text{Efficiency of rivets} = \frac{A \cdot N \cdot S}{P \cdot t \cdot T} = \frac{.7854 \times 2 \times 44000}{3 \times .625 \times 50000} =$$

$1.35 \times 1.27 = 171 \text{ per cent.}$

In which P = Pitch of rivets.

D = Diameter of rivet hole.

A = Area of rivet.

N = Number of rivets.

t = Thickness of plate.

S = Shearing strength of rivets.

T = Tensile strength of plate.

Of the two methods the latter is preferable, as it is shorter and allows the designer to compare the efficiency of the patch seam with that of the longitudinal seam. In case the efficiency is equal to or greater than the longitudinal seam the Government alteration report can then be marked "Stresses not changed."

Quoting further from the previous mentioned article, we are advised that "There is still much to be learned about diagonal joints. We need tests of them, made on a large scale, so that we may know exactly how the plates will behave under the oblique stresses to which they are subjected.

The only published experimental data that we recall at the present writing are those relating to a test made in England, about twenty-five years ago, by Mr. Kirkaldy. He made up two single-riveted joints of iron plate, .38 in. thick, and having a tensile strength (with the grain) of 39,380 pounds per square inch. One of these was an ordinary square joint with six 13/16-in. rivets, pitched 2 in. from center to center. The other was a similar joint, except that it contained 8 rivets, and was inclined at an angle of 45 deg. to the direction in which the stress was applied. In the tests, the square joint gave an efficiency of 48 per cent., while the diagonal joint gave an effective efficiency of 64 per cent. In other words, the tests showed that the diagonal joint was stronger than the square one in the proportion of 64 to 48; that is, it was 1.33 times as strong. Table II indicates 1.27 as the theoretical ratio in this case. This is as good an agreement as could be expected; but more extensive data would be very acceptable."

Figs. 4, 5, 6 and 7 show patches designed in accordance with the foregoing, in which Figs. 4, 5 and 6 show patches covering pitted portions, while Fig. 7 shows a patch applied on account of cracks around a washout plug hole. Fig. 8 shows a liner applied around the first course of a crown bar boiler, on account of pitting completely around the tube

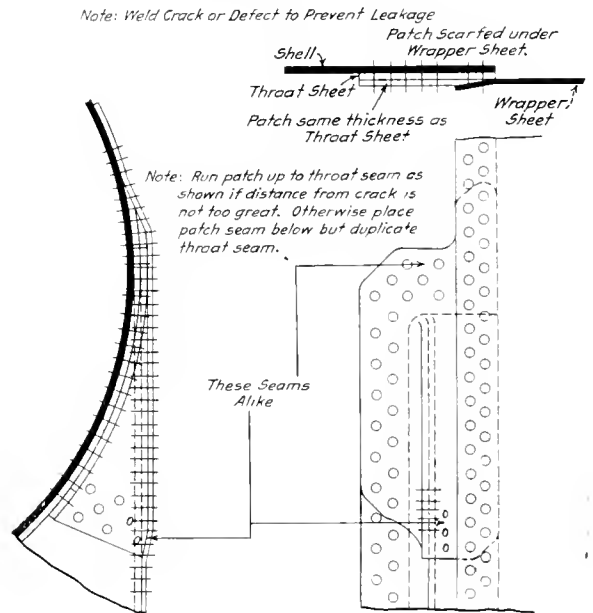

Fig. 9—Throat Sheet Patch

sheet, in which the liner seams duplicate the first cylinder course circumferential seams. Fig. 9 gives instructions for applying throat sheet seams.

In the application of patches, it will be well to clean out all pits and cracks and fill them by welding, thereby checking the defects from spreading. The patches should be applied on the inside if possible.

For the patch, small cracks that develop while the engine is in service, a patch similar to that shown in Fig. 7 can be designed to be applied with patch bolts, which can later be replaced with rivets when the tubes are renewed.

To save duplication of reports, it is suggested that the badge plate be stamped with the letter R when all of the patches then on the boiler are reported. Future patches would, of course, be handled as they are applied.

Attention might also be called to the fact that some shops are using firebox steel instead of boiler steel for patches,

which practice should be discontinued as the firebox steel is more expensive, besides usually running lower in tensile strength.

The drawing room can work up seams adaptable to various patches on the different classes of locomotives arranged in such a manner as to be perfectly clear to the boilermaker, so that he can apply a patch without having a drawing of the particular patch that he is to apply. This will reduce the work in the drawing room to a large extent.

WORK DISTRIBUTION IN THE ROUNDHOUSE

BY JOHN F. LONG

As an engine arrives at the terminal the usual means of arriving at its condition is the engineman's report, which is made out in a work report book. This is supplemented by the roundhouse inspector's report. The work required by these reports is then copied on slips, one for each job, if the terminal is a large one, or one for each class of work if the terminal is small. These slips should always be dated.

In a large terminal the time of the foreman will be taken up very largely with the purely routine work of seeing that these slips are properly distributed, unless a well organized system for handling them is worked out. The following system is one which serves this purpose successfully.

An oblong box should be located on the foreman's desk, divided into three compartments, one marked "Work," one "Hold" and the third "O. K." When the foreman gets the slips out of the "Work" compartment where the clerk has placed them, he goes over them and decides just what should be done. If he intends to do all the work reported, he or his assistant begins distributing the slips. If, on the other hand, he finds various items which he decides should be done later, he places these in the "Hold" box.

In addition to the box, a board should be provided on which is placed the number of each engine handled at the terminal with a hook under the number. All uncompleted work slips should be distributed on these hooks. For instance, if the traveling engineer or the master mechanic writes in from the line calling attention to certain work that should be done on engine 999, the foreman may receive the letter while the engine is on the road. He then immediately hangs it on the hook under number 999, and should this engine come in, either during the day or night, the report is not so likely to be overlooked as if it were placed in an open file. On the other hand, suppose the foreman desires engine 999 held. He places an order on the hook under 999, specifying the work necessary to be done. If the engine arrives at night, the night foreman knows immediately that it should be placed over the drop pit in readiness for the day men to begin work.

In the roundhouse flat blackboards should be placed near the men's lockers, one for each class of work or gang. These should each have three hooks marked "Work," "Hold" and "O. K." To distribute the work slips they are hung on the "Work" hooks, each group to be taken up by the men assigned to that class of work. If a gang leader is unable to do a certain piece of work to-day, but can get out the material by the time the engine returns from its next trip, he places the slip on his "Hold" hook. By this method a job once reported is never lost sight of until it is finished, and the amount of attention required on the part of the foreman to follow it through is reduced to a minimum.

When a job is completed the man who did the work signs the slip and hangs it on the "O. K." hook, to be collected by the foreman and turned in at the office, where the job is marked "O. K." on the work book, and the slip filed.

By means of this system the foreman is saved the time which would otherwise be spent in looking for men about

the roundhouse when distributing the work slips. Each man or gang foreman, as the case may be, comes to his board whenever he has finished a piece of work and, taking the slips which he finds there, proceeds to the next job. The foreman is thus free to give his attention to his more important duties.

This system also makes it possible to locate the men in the roundhouse when they are needed for hurry-up jobs. As each man takes up a new job he hangs the work slip on the "O. K." hook without signing it. It is evident, therefore, that each unsigned slip on the "O. K." hook of any gang indicates the location of the particular member of that gang.

BABBITTING VALVE ROD CROSSHEADS

BY J. A. JESSON

The device shown in the illustration is used for babbitting valve rod crossheads. With it the surface can be obtained so smooth that machining is unnecessary, and this materially cuts down the labor cost for this work. The device consists of two wedges, A and B, having a tongue and groove fit. They are adjusted to position in the crosshead by four ad-

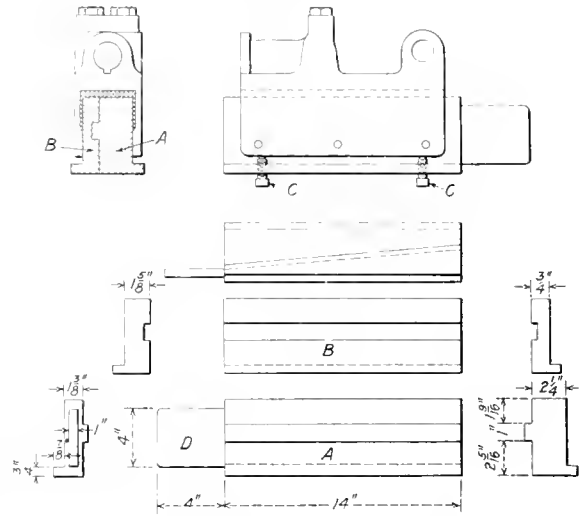

Method of Babbitting Valve Rod Crossheads

justing screws, C. After the wedges have been set to give the proper clearance, they are driven in tight against the sides of the crosshead. The lug marked D is used for separating the wedges after the babbitt has been poured. This device was designed by W. J. Young, machine shop foreman of the Louisville & Nashville at Corbin, Ky.

ELECTRIC DRIVE FOR BATTLESHIPS COLORADO AND WASHINGTON.—Contracts totaling approximately \$2,000,000 have been placed recently with the Westinghouse Electric & Manufacturing Company by the New York Shipbuilding Company for furnishing the necessary electrical equipments for the propulsion of the new super-dreadnaughts Colorado and Washington. The equipments to be furnished are practically of the same design as that contracted for by the Navy Department for the U. S. S. Tennessee now building at the New York navy yard. The four propellers, as in the case of the Tennessee, instead of being mechanically connected to driving engines or turbines, are to be driven by individual motors. The current for the motors will be furnished by two turbine generators.

ASSISTING SHRINKAGE IN AUTOGENOUS WELDING BY MECHANICAL MEANS

BY E. S. NORTON

The greatest difficulties to be overcome in autogenous welding are produced by expansion and contraction and they are especially troublesome in welding locomotive firebox sheets. Welding vertical cracks through several staybolt holes in bad sheets will invariably start trouble in the next parallel row, the cause being checks on the water side that develop and extend when contraction strains are set up at the adjacent row. It is generally supposed that the electric welding process with its small area of heating and limited amount of expansion takes care of all work of this kind. While there is no doubt about its success in a good sheet, it may fail if the sheet is checked on the water side.

In the job which was finally handled as shown in the sketch, a vertical crack was found which extended continuously between nine staybolts. This was electrically welded, and on cooling the next row of parallel bolts showed a crack eight bolts in length. On welding this row the next one cracked for a length of four bolts. The sheet had one

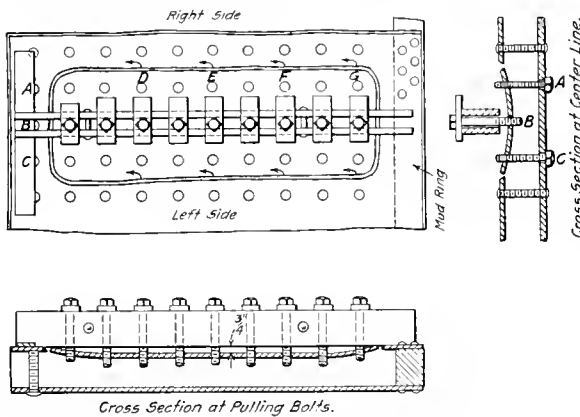

Method of Applying Firebox Patch to Remove Mechanically the Shrinkage Strains

riveted patch, and with this additional trouble, it was slated for the scrap pile. There was only one thing to do: weld in a patch and finish the sheet without leaving any shrinkage strain.

In the sketch, row A was the first one welded, B the second and C the third. These three lines of bolts were cut out and a box patch placed as shown. Rows A and C were flexible bolts and screwed in position to hold the patch in proper relation to the side sheet. It will be noticed that the patch is dished about $\frac{3}{4}$ in. towards the water side which allows $\frac{1}{8}$ in. for shrinkage when the patch is brought out flush with the sheet. Over row B and extending the width of the sheet were placed two parallel bars one inch by four inches, riveted together one inch apart. Between these bars and extending into the holes of row B $\frac{7}{8}$ -in. bolts, supported by straps, were screwed tight. The upper ends of the bars were supported by a plate which extended horizontally along the sheet for a distance equal to about five rows of staybolts; the lower ends were supported by the sheet and mud ring. The sheet was thus protected from a concentration of the load on the bars.

A patch of this kind should not be tacked unless absolutely necessary. The weld was made with oxy-acetylene, beginning at point D on the right side and working up to the corner, then dropping to E and working up to D, and so on, finishing the right side at F. This method of dropping down by eight-inch steps equalizes the strains and keeps the work at a more uniform temperature, as the be-

ginning of each section is made on cold metal and finished on metal which has had time to cool. The left side is welded in the same manner, but as the weld proceeds pull the dish out of the patch with the middle line of bolts. If necessary, the completed weld on the other side should be reheated.

The parallel bars are removed after the vertical welds are completed, and the ends finished. This method of applying the patch leaves the sheet without tensile strain after the weld has been completed.

VAPORIZER FOR BURNING KEROSENE

BY CHARLES N. COONS

By means of the device shown in the illustration kerosene is being used very successfully to remove and replace locomotive tires. With suitable burners it can also be used for other classes of heating operations, the flame being much the same as that produced by gasoline.

The equipment is mounted on a small four-wheel truck and can easily be moved from place to place. At the back is placed a reservoir 12 in. by 35 in. On top is shown a hose connection for air and a funnel for applying oil. Standing upright in front of the reservoir is a piece of boiler steel $\frac{1}{8}$ in. by 18 in. and two feet high, in front of which is located an oil burner. Beyond the burner is a drum, inside of which is a coil of $\frac{3}{4}$ -in. pipe 10 in. across and 25 in. long. The end of this coil extends through the outer end of the drum and to it the tire hoop is coupled with a union. The oil pipe leads from the bottom of the oil reservoir and is fitted with a $\frac{3}{8}$ -in. check valve. The air line extends across the top of the reservoir and is fitted with a $\frac{3}{4}$ -in. check valve. Just above the bottom check are two needle valves. One controls the oil to the burner and the other controls the oil to the tire hoop. Above the needle valves are two globe valves, one

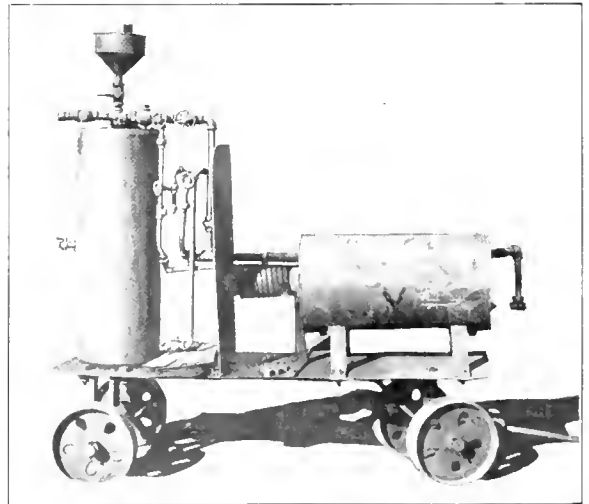

Equipment for Vaporizing Kerosene for Heating Tires

controlling the air to the burner and the other the air to the tire hoop.

When the device is to be placed in operation, the burner is lighted, throwing a steady blue flame into the drum. This heats the vaporizing coil through which the air and oil for the tire hoop passes. The result is a steady blue flame, which entirely encircles the tire, making it possible to remove or replace the tire in the shortest possible time. These machines can be operated by any handy man with perfect safety,

making the cost of operation very low. Four of them are now being used at various points on the Illinois Central.

NOVEL USE FOR CAR WHEEL BORER

It is seldom that a tool designed especially for work on one particular part is well adapted to operations on other parts. A car wheel borer was, however, converted into a very efficient machine for boring and facing driving boxes by the addition of the devices shown in the illustrations below. The general arrangement of the borer with the special appliances and some of the details of the special head for the facing bar are shown in the illustration. The center of the table was bored to receive a brass bushing, and a special boring bar extending into the bushing was provided. It was also necessary to design a special head for the facing bar to give sufficient clearance between the table and the facing tool. The offset head was forged from mild steel and accurately fitted to the cross bar. In the end of the head a tapering slot was machined to take the tool holder. The vertical adjustment

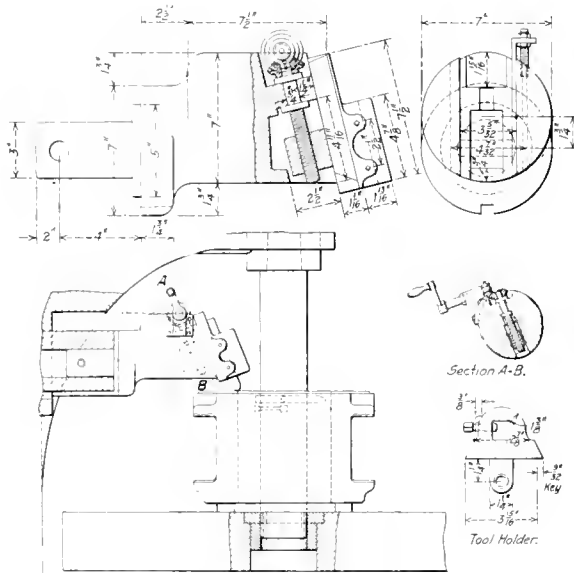

Car Wheel Borer, Arranged for Machining Driving Boxes

of the tool was secured by a screw controlled by bevel gears and a handle carried in a bracket on the head. The tool was held in the slot by two set screws. As the special head brought the cutting point of the facing tool closer to the axis of the bar than the original arrangement, the rigidity of the bar was not impaired. The boring bar, supported by the bushing in the table, was very rigid and the results obtained with the machine were highly satisfactory.

CUTTING STEEL WITH OXYGEN.—The following examples of good average cutting are from experiments with a hand oxygen cutter, which was only altered as required for the gas pressure corresponding to the thickness of plates:

Thickness of plate.	Metal cut per hour.	Oxygen consumed per hour.	Pressure of Oxygen (atmospheres).
Mild Steel.			
1 1/2 in.	60 ft.	60 cu. ft.	2
1 in.	40 ft.	90 cu. ft.	2.5
1 1/4 in.	30 ft.	105 cu. ft.	3
2 in.	25 ft.	120 cu. ft.	3.5

The oxygen hand-cutter has been found valuable and economical in cutting up all kinds of steel work.—*Institution of Mechanical Engineers.*

STAYBOLT HOLDER-ON WITH AUTOMATIC RECOIL

BY PERRY J. SWEZEY

When a sledge or solid bar is used for holding on staybolts when riveting them with a pneumatic hammer, the hammer strikes so fast that the holder-on cannot keep his sledge or bar up to the head of the bolt to receive all of the blows that the hammer delivers. At least 35 per cent of the blows are not only useless but a detriment to the boiler.

With the tool shown in the sketch an experienced man can hold on staybolts just as long as the man with the hammer

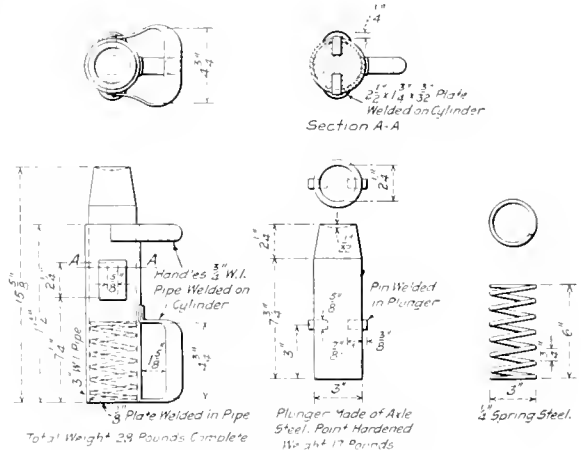

Staybolt Holder-On for Use with Pneumatic Hammer

wants to drive. It eliminates the constant jar of the ordinary bar, thereby making it easier for the operator, and is always back on the staybolt ready to receive every blow from the hammer, thereby increasing the efficiency of the pneumatic hammer. The piston bar weighs 17 lb. and rests on a 6-in. coil spring of 1/4-in. spring steel. Both are enclosed in a casing of 3-in. pipe 11 1/2 in. long which is closed at the bottom with a 1/8-in plate welded in place. On opposite sides of this cylinder, 7 1/4 in. from the bottom, are cut two slots 5/8 in. wide and 2 1/4 in. long. These serve as guides for 5/8-in. pins welded in the plunger, and are closed by dished patches of 3/32 in. plate welded on the outside of the pipe after the parts are assembled. The plunger is thus always kept in the casing, in which it has a maximum movement of 1 7/8 in. The device is provided with convenient handles of 3/4-in. pipe welded to the casing.

The tool complete weights 28 lb. and is operated in the same manner as an ordinary bar, except that the piston bar inside of the casing must be held down on the spring about one inch to get the desired result. The plunger will then recoil as fast as the pneumatic hammer strikes.

Anyone who is familiar with the operation of driving staybolts with a pneumatic hammer can readily see the improvement which will result from the use of this tool.

LOSS OF HEAD DUE TO BLENDS IN PIPE.—The loss of head due to curves and fittings is usually stated in terms of the equivalent length of straight pipe of the same size that would cause the same or equal loss. Experiments show the radius of minimum resistance for right-angle curves to be from 2 to 3 diameters of the pipe. For 6-in. water pipe the minimum loss is about the same as 8 ft. of straight pipe, and for 30-in. pipe about 40 ft. of straight pipe. Intermediate sizes vary between these limits approximately as their diameters.—*Power.*

"CLEANING UP" MUNCIE ROUNDHOUSE

Rebuilding a Demoralized Organization; How Tom Carleton Handled His Foremen and the "Old Man"

BY HARVEY DE WITT WOLCOMB

"AND now just one word of caution," said Mr. Andrews, the master mechanic, as he sat in his office, holding his first conference with Tom Carleton, the newly appointed general foreman at Muncie. "You are probably aware of the fact that many men imagine it necessary to fire every last man about the plant—I believe you call it 'cleaning house'—but I do not like those tactics and feel that your success should be measured by the good work you can secure from our present force, therefore I wish to caution you not to take any hasty action. Before you make any decisive move, just stop and think that perhaps the very man you want to discharge has worked for us a long time, and that he knows his business very well although he may have become lax. By taking a little interest in his case, you may be able to straighten him out so that he will do much better than a new man would."

"All right, Mr. Andrews," replied Tom, "but if after going thoroughly into a case, I find there are no good grounds on which to re-construct, I trust you will stand with me in every decision I make."

"If it becomes necessary to go that far," continued Mr. Andrews, "we will look into the case and advise you whatever action you may take."

"But can't you see I am here to run this place?" quickly spoke up Tom. "And believe me, I intend to run it first, last and all the time. If I have to take up every little thing with your office, you will have me writing letters all the time; therefore my methods will be to get results first, and then confer with you afterwards. Mr. Andrews, I am in the habit of doing things, not just talking about them, so leave it to me till I have fallen down on something and then we will arbitrate," lamely added Tom, for he saw that he had made a grave mistake by showing his temper at the very first conference with the master mechanic.

He got away from the conference as soon as he could and arrived at his office in anything but a pleasant frame of mind. For, aside from the fact that he thought he had made a fool of himself, he had discovered at the very outset that instead of being permitted to do all the big things he had planned, the management intended to tie his hands so that in reality he would be simply a "go between." If he wanted to call a man down, it would be necessary to first talk the matter over with the higher officers, for sometimes a man won't stand the "gaff" of a genuine "call down" but will talk right back so that the upshot is that one or the other of the parties must quit. After the talk he had just had with the master mechanic he realized that there probably would be some unpleasant questions asked if any one of his men should resign. Tom could see that he was in a tight place. Knowing the nature of railroad men in general, he had made up his mind to whip his force into shape by holding that dreaded demon "discharge" over their heads, for he knew that many good men who are slow to anger, will take a "call down" to heart so seriously that they will resign; but talk "discharge" to them and they are soon persuaded to do what is expected of them. Well, there was no use of locking the barn after the horses had been stolen, so he thought he might as well get on the job and do the best he could. Tom's strongest argument in the past had been that no man can tell what he can do until he has tried, so he might as well try some of his own medicine.

In taking up his mail, he could not help noticing the sharp

contrast between the light and clean office of the master mechanic and the dingy hole he had to call his headquarters. As he would probably spend his best hours in this very office, why should he not have the place fixed up a bit. In the master mechanic's office there was a clean wash bowl with hot and cold running water; in his own office there was an old bucket always about half full of dirty water. The windows were very dirty and the paint was almost black with soot. Many spots showed where men had come in and leaned up against the walls. In order to make a start in fitting up his office so that it would resemble the abode of a human being, he sent for his paint shop foreman, intending to have him wash out the place and then give it a fresh coat of paint; but he was very much surprised and irritated to have that worthy person inform him there were no men he could spare just then to put on the job. Though disappointed in not being able to have the work started at once, Tom said nothing more about the matter to the foreman.

On going out in the roundhouse, he noticed several steam leaks in the overhead pipes, and as a steam leak always appealed to Tom as a needless waste of money, he sent for his pipe shop foreman intending to have the matter given immediate attention. Again he was to receive a shock, for the pipe foreman readily admitted that he had known for some time about those leaks but had been unable to get around to them because his men were so busy. Now to any man but Tom this might have sounded all right, but he had noticed during the past few days, that there weren't many men around the house, yet there were just as many carried on the pay roll as before. Tom, being a past master in the in's and out's of roundhouse work, surmised where the men were, and decided to teach his foremen a good lesson at the first opportunity. This opportunity soon held out both hands to him. His ash pit foreman came up and asked for more men, saying that he was tied up on the pits.

"Will twenty good strong men for the balance of the day help you catch up with your work?" asked Tom. "They certainly would," replied the ash pit boss, feeling elated at having "slipped something over" on the new boss.

"All right," replied Tom, "come with me and I will get you the men." Starting for the turntable pit, they turned at right angles when they reached the doors of the house and then going around three or four pits, Tom turned in between two engines and came back toward the outside of the house. In the very first cab to which they came, they found a good husky workman sitting on the fireman's seat, smoking his pipe. When he spied Tom looking up at him through the gangway he acted as if he wanted to swallow pipe, tobacco and all. But it was too late, for he was caught fair and square, and there was nothing to do but obey when Tom said curtly, "Report at my office at once; I have a special job for you. If I am not there when you get there, remain till I come."

Before reaching the next engine, the ash pit foreman volunteered the information that the fellow whom they had just sent to the office was the best pipe fitter at Muncie, but as Tom did not seem to be in a mood for conversation there was no further talk. In the next cab they dug out three workmen, and, after directing them to report to his office, Tom continued on the way through the house till he had secured the twentieth man. Then turning to the ash pit foreman whose face showed his astonishment at what was going on, Tom

asked if that would be enough men. Receiving an affirmative answer, they both started for the office. On coming up to the gang there assembled, Tom said simply, "Men, the ash pit boss is short of help today, and as none of you fellows are working, I guess we can spare you to help us out on the pit for the balance of the day."

Now the very first man whom Tom had kicked out of a cab was the leader of the local grievance committee. He immediately assumed the dignity fitting one of his exalted position by making a protest against any such action, saying that he was a pipe fitter, not an ash shoveller. "Thanks awfully for felling me," said Tom, "for from what I saw you doing, I did not know whether you was a good pipe fitter or a good ash shoveller. You have first to prove to me that you are a good ash pit man before I will believe you are a good pipe fitter. You can go with these men or get off the place." There was no argument against this statement. The men, sensing the weakness of their position and the determination of the new foreman, followed the ash pit boss out of the roundhouse.

Tom knew what to expect from the foremen and he went into his office to await developments.

The boiler foreman, with blood in his eye, was the first one to come in; then the pipe shop foreman came along, and soon most of the foremen about the place were there. As each man came into the office, Tom told him to wait a few minutes, as he wished to take up some important matters with them. The foremen noticing that apparently all were there thought that the new general foreman was going to hold a staff meeting, so they made themselves comfortable. It had been the custom to hold occasional staff meetings of the foremen, which usually settled into discussions among two or three foremen, while the other men either slept or drew pictures on the backs of their work order pads.

Tom's predecessor had been a vain, self-conscious mechanic who thought himself a very wise man. His foremen had early discovered that they could handle him as they pleased by the judicious use of flattery. In fact, the boiler shop foreman made his open brags that the boss did not know anything about boilers and could be made to agree to anything, so that he had everything his own way. Other foremen had developed their own methods of handling the boss, and all in all, there was a general feeling about the place that a general foreman was a joke. Right here, however, they were to wake up to the fact that they had a real man to deal with and that they would have to play ball or get off the team.

As soon as everyone was settled, Tom said, "Gentlemen, this is evidently some kind of a meeting which is a surprise to me but as you are all here, I wish to say that the next time I catch another workman up in a cab loafing or smoking, I will discharge his foreman. I have noticed for some time, the scarcity of men about the place but when I look in the cabs, it does not take very long to find 20 extra men. I have taken the first twenty I came to and put them to work on the ash pit for the balance of the day, where they will earn, at least, a little of their pay. From now on, I will depend on you gentlemen to see that your men are on the job all the time. If they do not have any work, tell them to remain at the work benches so that we can see if we have any great surplus of workmen."

The boiler shop foreman spoke up: "But Mr. Carleton, it is not the policy of this company to discharge its foremen without first taking the matter up with the higher authorities."

Tom inwardly groaned, for he could see the influence of the policy established by the master mechanic, supposedly in the interest of a square deal. He could see how his predecessor had lost all hold on the men by working constantly in fear of making a wrong move. There isn't a man living who does not hate to back up after he has once taken a

decisive stand. With Tom it was a horse of another color for he had always been trained to act first and then to receive the support of his master mechanic, who had always placed the greatest confidence in him. Well, if he wasn't going to be able to handle this job he might as well find it out now as later, so squaring his jaw he came right back at the foremen. "Let me tell you one thing right now," said he. "It is the policy of this company to get its work done, and I am here to see that it is done. That is the only policy I am interested in. If any one of you came here to question me about taking your men and sending them out to the ash pit, I believe you have been sufficiently answered. Now, I guess you can get on your jobs."

The next morning, Tom's office was being cleaned out preparatory to receiving a coat of paint, and the steam leaks were fast disappearing all over the house. Besides, the place seemed to be full of workmen.

Shortly after this, as Tom sat in his office looking over his mail, he was annoyed by the humming of a pop on an engine just outside his office. Now Tom, like every other mechanic, really enjoyed the many noises that are always present in a busy roundhouse, but the pop on the engine outside his office was a discordant note because he realized that it was caused by a leaky valve. On going out of his office, he came across the man who looked after cab work and asked him what was the matter with the pop valve on this particular engine. "Oh, that pop leaks a little, I guess," replied the mechanic, "but not enough to hurt anything, for the inspectors haven't reported it yet, and I guess what is good enough for them is good enough for the old N. & O."

This remark "got Tom's goat," for of all the things he detested, it was the excuse of a half-rate mechanic for a poor job. In his mind there were just two ways of doing a job—the right way or no way at all—so he waded into that machinist in a manner both forcible and instructive. "Why, man alive," said Tom, "don't you know or realize that every report turned in by an inspector is simply a reflection on your ability and good judgment as a mechanic? Don't you know, or pretend to know as much about your trade as one of the inspectors? This engine was repaired only a few days ago and now you tell me that you are waiting for some inspector to condemn your work before you will make it right. Haven't you any pride in your work? I have as much pride in my calling as any other professional man and you should too. Now will you see that that pop is fixed or will it be necessary for me to get it done myself?"

This machinist was a good workman but had fallen in with the slipshod methods generally prevailing at Muncie. Tom's reproaches made him very much ashamed of himself. "Mr. Carleton," he said, "I am considered a first class machinist and am proud of it. From now on you needn't worry about the quality of my work."

Instantly Tom shook hands with the man, saying, "With that spirit your success, my success and the success of the N. & O. is assured."

Before Tom had been on his new job long, he discovered that the weakest point in the facilities of the terminal was the machine shop, which was suffering from a lack of sufficient machine tools. He knew it would be a waste of time to simply suggest what he wanted, so he dug into the matter with his usual thoroughness, making a careful study of the whole situation. In talking the matter over with his machine shop foreman, he was surprised to learn that it was the general practice about the terminal to order just twice as much as any one needed, for it was the custom of the master mechanic to cut all requisitions in half. Tom did not like this method of doing business, and as he was serious about what he wanted, he carefully made up his list of new equipment, feeling that if the master mechanic could talk him out of any of the machines he had on his list, he would have to acknowledge a fair and just defeat. Completing his

list, he went over to the office to have it out with the "Old Man."

Now the master mechanic really knew that the machinery at Muncie was out of date, but like many other officers, he thought he was making a record by not spending any money for new equipment and that the old tools would do so long as they held together. He felt that so long as the shop forces could get along with the old equipment, there was no use of spending money for new and he had "bluffed" every man who had ever made a request for new equipment. But with Tom on the job, he was up against a different proposition. Tom knew what he wanted first, then he developed and tested his arguments so well that the "Old Man" soon realized he had bumped up against a fellow who could not be put off with the old plea of economy. As there was no use in argument, the master mechanic promised he would have a special man from his office look into the matter and make a report with recommendations. Instantly Tom "went up in the air" for all the time and attention he had just given to the subject apparently was wasted. The chances were that the fellow who would be sent down to make the investigation would be some man with no actual experience in roundhouse machine shop requirements, and Tom did not feel like spending any more of his valuable time on the education of such an individual. With these thoughts running in his mind, Tom asked the master mechanic if he did not think that the general foreman had the ability to select such machinery as was required in his own shop.

"Oh yes," he replied, "I have all the confidence in the world in you, but the regular routine in a matter of this kind is to have one of the young men out of my office make the investigation and recommendations for new machinery. Besides I have a new fellow here who is just out of college, who claims to have made a special study of machinery requirements, and I would like to try him out to see what is in him. You must certainly agree with me that everybody should have their chance." Tom could see that it was useless to argue the matter further for he was up against regular routine and a pet hobby of the "Old Man's," so he reluctantly gave up for the time being, but resolved that he wasn't through yet. There surely must be some way whereby he could secure what he needed.

There are several types of men in the railroad world who seem to get along well with their work, yet no two of them go about their duties in the same way. Tom never "cussed" anybody, nor did he drive his men unmercifully, yet he seemed to get results. The men were right up on their toes all the time, although no one ever complained about how hard he was working. Tom always said that if you were first sure that you were right, no man would hesitate to do as requested. He always put a lot of thought on his problems, and wasn't satisfied until he had found a solution that was simple enough to be practicable.

Accordingly during the days following his request for the new machinery, Tom did some pretty tall thinking. One day a thought struck him like an inspiration and he smiled all over. He immediately laid his plans to get the best of the "Old Man." The master mechanic at Muncie, like many other good railroad men, had overtaxed his physical and nervous strength while a young man with the result that now in middle life, he was not in rugged health. He frequently had to call on the doctor in order to keep up and at his duties. So Tom waited until he knew that the "Old Man" was feeling pretty bad and then he went in the office to see him.

On entering the master mechanic's office, he said he had come over to talk about some special business, but first wanted to take up some important matters concerning a couple of engines then in the roundhouse. After this business had been settled Tom leaned back in his chair and remarked that he did not look very well that morning. Mr.

Andrews admitted he was not feeling very well, but thought his doctor would soon fix him up.

"By the way, Mr. Andrews," said Tom, "I have a young friend just out of college who has made a special study of the human body and I would like to have him tackle your case so that we can see just what is in him. You must agree with me that everybody should have their chance."

The "Old Man" looked at Tom as if he wanted to eat him, but as Tom returned his gaze in a straightforward manner, he decided that there was nothing personal in Tom's remarks. It didn't set very well, though, to be asked to offer himself as a sacrifice for some cub of a doctor to practice on. Tom did not give him time to frame a reply, however, before he continued: "Mr. Andrews, plug your heart and you die; plug your machine shop and your roundhouse dies. You did not hesitate to tell me that you would let some young man experiment with the main artery of my work, to give him a chance, yet you are offended even at the thought of placing yourself in the hands of an inexperienced young doctor. I know what my machine shop requirements are. I am the doctor who has had the long experience, therefore can prescribe just the remedy needed to keep my patient alive and healthy. Here is the prescription I would like to have filled." So saying, Tom handed the master mechanic the same list of machine tools the master mechanic had refused to consider a few days before.

The boss was beaten and he knew it. He didn't try to beat around the bush any longer. Calling in his chief clerk, he gave orders for the placing of requisitions to cover the list of tools.

Some new machine tools are now arriving at the Muncie roundhouse and the men are wondering why the master mechanic has taken to calling their general foreman "doctor."

LOCATING DEFECTIVE SAFETY VALVES

BY F. W. BENTLEY, JR.

Due to the close grouping of safety valve sets on many types of locomotives, together with the surrounding arrangements of dome casings and other attachments, it is some-

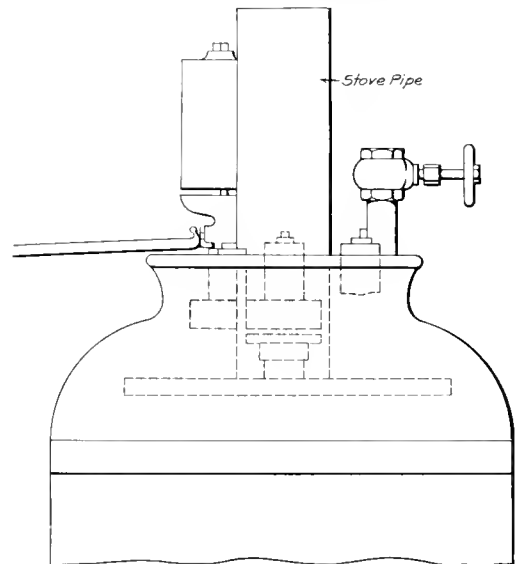

Method of Locating Defective Safety Valves

times a difficult proposition to locate a leaky valve. The one giving the trouble generally fill the casing with steam and at night it is often an impossibility for machinist or engineer to locate the defective valve without raising the

casing. The arrangement of other parts on the dome frequently prevents this until the engine is cooled down.

A very simple method of quickly ascertaining defective valves is shown in the illustration. It consists of a common stove pipe which can be dropped down into the casing and over the valves. When it is placed over the leaking valve the steam will be carried clear of the casing through the pipe. Where the casing cannot be removed and the work is hampered by lack of light and weather conditions, the above method is a very practical way of quickly finding the bad order valve as well as eliminating the results of what is sometimes a bad guess.

AIR HOSE CONNECTION FOR PITS

BY R. L. PRESTON

The air hose connection shown in the drawing is used in the place of valves in the pit air line. It consists simply of a check valve, having a ground seat in the cage which fits into the air line. As the hose is screwed on to the valve cage, the cone-shaped end of the air hose connection, raises the valve from its seat, allowing the air to flow through the pipe. Previous to the adoption of this type of check valve, con-

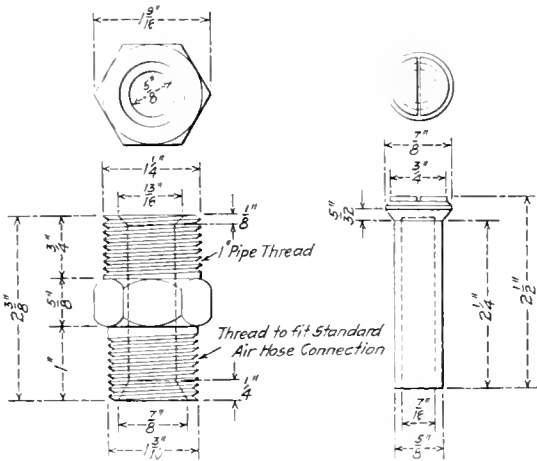

Air Hose Connection for Locomotive Pits

siderable trouble was experienced with the cut-off cock being broken off or getting out of order while working about the pit. This arrangement causes no trouble and prevents the loss of air due to broken valves. The stem of the valve is 5/8 in. in diameter, filed or ground down to a thickness of 7/16 in. on two sides as shown in the illustration.

PORTABLE FLUE CUTTER

BY W. S. WHITFORD

The portable flue cutter shown in the illustration has been found to be a serviceable tool, especially in an engine-house where on account of the three-year limit for locomotive tubes set by law, it is often necessary to renew some of the tubes. The body, or upper part of the machine is forged from a piece of soft steel 2 1/2 in. wide and 1 1/2 in. thick. In the center at the top a boss 4 in. in diameter receives the threaded stem of a yoke which carries at the bottom two 2 1/2-in. cutters. This yoke is free to slide up and down in the frame and is controlled by the handwheel as indicated in the drawing. Between the legs of the main frame extends a bearing for the large cutter which is 9 in. in diameter. This cutter is mounted on a shaft having a Morse taper shank on which is

placed an air motor. This remains in a fixed position. To cut a tube, the yoke is lowered for the tube to be inserted between the two small cutters and the large cutter, and it is then raised until all three cutters bear on the tube. The large cutter will travel at a high velocity and as the yoke is

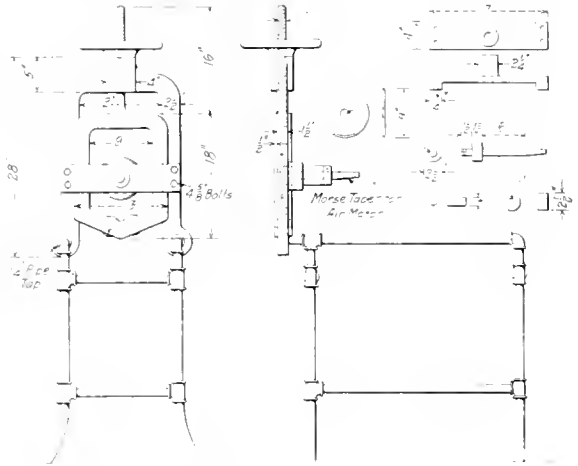

Portable Flue Cutter for Engine Houses

raised, the tubes are easily cut. It will be seen that this machine will easily handle a superheater flue. The whole device is mounted on a framework made of 1 1/4-in. pipe.

EMERGENCY REPAIRS TO STRAIGHT AIR BRAKE VALVE

BY F. W. BENTLEY, JR.

The upper or thread portions of the air valves of the Westinghouse S-3 brake valve sometimes break off when the leather disk holder is drawn down into place on the stem. As the threaded portion is a part of the stem itself, the stem is rendered useless when it gives way. As such breakages do not often occur, stems are seldom carried in stock.

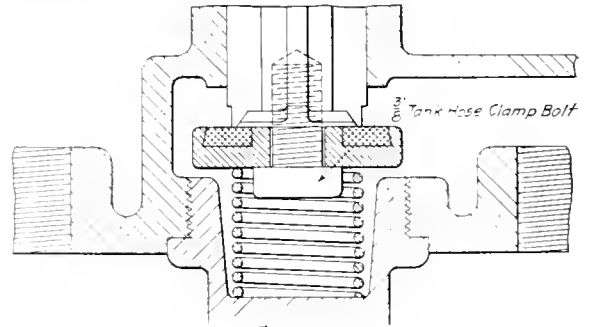

Method of Repairing Broken Straight Air Brake Valve Stems

The sketch shows a method of emergency repairing which enables the valve perfectly to perform its function until a new one can be secured and applied. The broken portion is filed off flush with the top of the stem and a hole for a 3/8-in. tap drilled down into the body about 3/8 in. deep. The construction of the lower part of the stem permits this if the drill is run in accurately. This may be done with almost any kind of a breast drill if necessary. A common 3/8-in. tank hose clamp bolt, sawed off to a length of about 3/4 in. under the head provides a very convenient tap bolt by means of which the valve can again be drawn down firmly on the stem. The hose clamp bolts are used at all points.

New Devices

FOSTER UNIVERSAL TURRET LATHE

The wide range of work for which turret lathes adapted to both chucking and bar work can be used makes such tools particularly useful in railroad shops. A machine of this character, called the type 1-B universal turret lathe, has recently been placed on the market by the Foster Machine Company, Beardsley avenue and Ward street, Elkhart, Ind.

The machine is of the geared-head type with a hollow hexagon turret on the longitudinal slide and a square turret on the cross slide. It has a hole $2\frac{3}{8}$ in. in diameter through the spindle, and will handle 2 in. round or $1\frac{3}{8}$ in. square bars. The swing over the cross slide is 8 in., over the carriage guides 14 in., and over the bed $15\frac{1}{2}$ in. The longitudinal travel of the carriage is 20 in. and the cross travel of the cross slide 10 in. The latter is fitted with screw cutting and taper attachments. For bar work it is equipped with a draw-back automatic chuck and for chucking work, with a three-jaw geared scroll chuck.

The head and the bed are cast integral. The bed is short and heavily ribbed with carriage ways of the V-type, having a large bearing area. The head is of the geared type, being

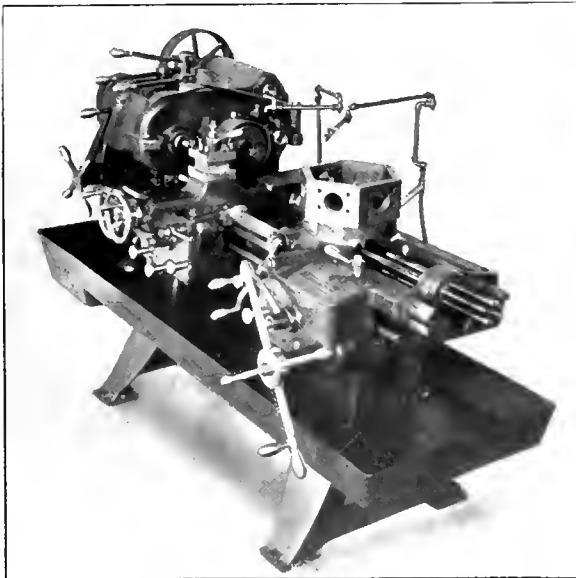

Foster Type 1-B Universal Turret Lathe for Bar and Chucking Work

driven by a single pulley, the shaft of which is mounted in phosphor bronze boxes. Twelve speed changes are obtained in either direction, by sliding gears controlled by levers mounted on the top of the head casing. All gears are heat treated and hardened. They are of the stub tooth form, which gives strength and quiet operation. The gears in the head run in a bath of oil. The friction clutch is designed to transmit power in excess of the greatest amount that can be delivered by the belt.

The spindle is made from a high carbon machine steel forging and runs in extra long bronze boxes. There are twelve spindle speeds ranging from 20 to 480 r.p.m., which makes it possible to secure the proper cutting speed for all classes of material within the limits of the size of work the machine will handle. The gear box on the end of the head contains the gears through which the feed rod for the tools is driven, and also carries part of the mechanism of the automatic chuck for the bar feed. The feeds for the cross slide vary from .0016 in. to 0.1 in. per revolution of the spindle.

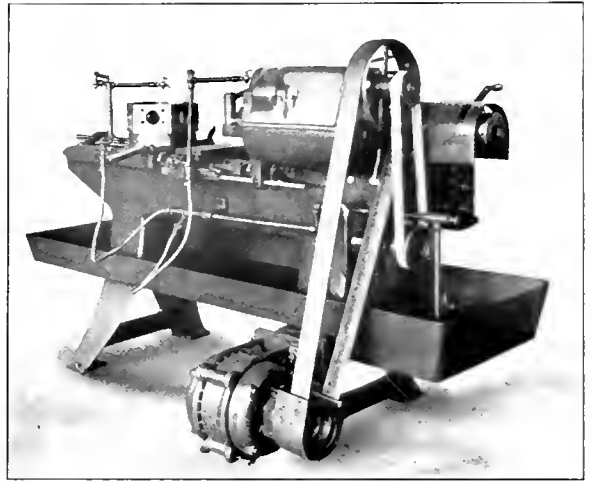

Rear View of Foster Universal Turret Lathe

The change mechanism is located partly in the gear box and partly in the apron. The gears controlling the changes and the driving pinion which engages with the rack on the bed are of heat treated chrome-nickel steel. The drive from the feed rod is through a worm and gear and the reverse and change gears are controlled by plungers. On the apron is a revolving spool which carries six screw stops. When one of these comes in contact with the adjustable stop rod it causes a longitudinal movement of the spool, which releases a catch and causes the horizontal lever to drop and thus releases the feed friction. The friction release for the cross movement is hand-operated.

To provide for duplicating diameters there is a dial of large diameter on the front end of the cross feed screw. A number of clips mounted on the dial indicate the setting for the sizes which are to be duplicated. A square turret designed for holding $\frac{1}{2}$ in. by 1 in. forged tools is mounted on the cross slide. Provision is made for mounting special tools, such as forming tools too wide to be mounted in the square turret, on the rear of the cross slide. A special mechanism on the cross slide makes it possible to withdraw the tool between cuts and then reset it and feed forward for the next cut. This is particularly useful when cutting threads. A handle on the carriage clamps it to the bed when desired.

The turret on the longitudinal slide is of the hollow hexa-

gon type with a large bearing surface on the saddle. One lever controls the lock bolt and the binding mechanism for the turret, and when it is moved the turret may be indexed by hand. The stop screws, seven in number, are held in a pool, on the saddle and geared to the parts and thus index with it. The feed stop is similar in design to that on the saddle apron. The feed changes provided are also the same as on the cross slide. The pump for the cooling compound is mounted on the rear side of gear box, and is driven by a belt from the main pulley shaft. A system of piping and flexible tubes carries the liquid to each tool. This piping can be arranged for oil tube drills or similar tools if desired.

The turret lathe is regularly equipped with overhead countershaft but is also arranged to be driven by a 5 h.p. motor running at about 1200 r.p.m., mounted on the rear of the front leg. An extensive equipment of tools and attachments can be furnished with the machine.

AUTOMATIC DRY GRAPHITE CYLINDER LUBRICATOR

An automatic graphite lubricator for locomotive cylinders which has been tested in service over a period of about two years, has recently been placed on the market by the United States Graphite Company, Saginaw, Mich. It uses fine powdered amorphous graphite, 98 per cent of which will pass through a 300 mesh screen. The graphite not only acts as a lubricant but it also has a tendency to hold the oil to the surface of the cylinders and prevents it from vaporizing.

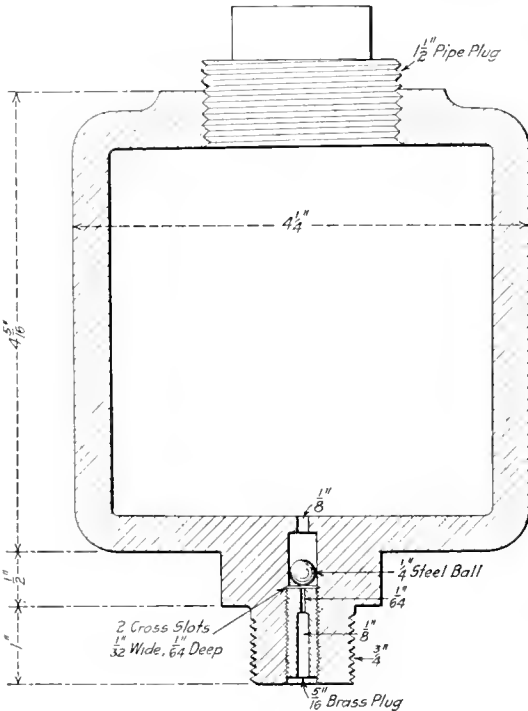

Automatic Dry Graphite Cylinder Lubricator

The lubricator is designed for engines using either saturated or superheated steam. Its cost is low; it is simple in construction and it may easily be installed. It feeds automatically and requires no attention aside from adding the graphite at the roundhouse. There is nothing in the mechanism which can get out of order and the feed of graphite cannot be tampered with. The construction of the device can be seen from the line drawing.

The lubricator may be applied anywhere on the steam chest or the relief valve pipe. The graphite is fed to the cylinders at all times, but the amount fed is greater when the engine is drifting than when steam is being used. It is claimed that this action of the lubricator makes it unnecessary to work steam on superheater engines while drifting.

It is claimed that the use of this graphite lubricator results in a saving in oil and a reduction in the wear of the cylinders, pistons and packing. It also makes the engine much easier to handle. The consumption of graphite is low, one-fourth pound being sufficient to lubricate one cylinder for 500 to 800 miles.

ELLIPTICAL GRATE BAR

A grate bar that has given noteworthy service in stationary and marine boiler practice and which has been adapted for locomotive use, is made by Thomas Grate Bar Company, Birmingham, Ala. As shown in the illustrations, this bar is elliptical in shape and of substantial construction. It has an upper and lower grid; the upper one to support the fire and the lower one to stiffen the bar structure. These grids are connected by lugs and are sufficiently far apart to permit free passage of the air through the grate.

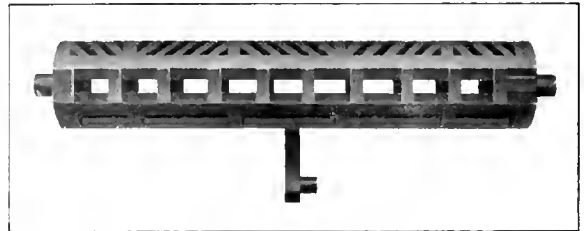

Elliptical Grate Bar for Locomotives

The rounding upper surface has the effect of dislodging the ashes by an abrasive action, rather than by tearing the fire, as is done with table or figure grates. The ribs in the lower grid, acting as a support for the bar, permit making the upper grid with air openings as high as 66 per cent of the grate area. Reports from users of these grate bars indicate that on account of their substantial construction, they have a long life. The lower grids being below the intense heat of the fire and provided with ample surface for dissipating the

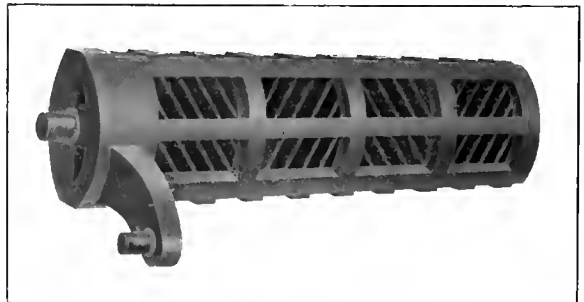

Bottom View of the Thomas Grate Bar

heat, do not readily become broken. It has also been found that less trouble is experienced with clinker, that the shape of the grates tends to keep them clean and that a uniform distribution of air to the fuel bed is obtained. It is also claimed by the users that less fuel is required and that greater steaming capacity is obtained from the boiler.

Another feature of this grate bar is that when the ribs in the upper grid become broken while in service, the hole can

be plugged by a clinker or other inert substance which will be supported by the ribs in the lower grid. This will give relief until such time as the bar can be replaced, and will prevent a serious hole in the fire. These bars are made of a grade of pig iron high in heat resisting qualities.

A CONVENIENT METHOD OF BOILER FEED WATER TREATMENT

Boiler compounds for the treatment of locomotive feed water are usually made up either in liquid or powdered form. The required amount must be applied to the tank each time the engine takes water, the effectiveness of the treatment, therefore, depending entirely upon the engine crew. It will generally be conceded that engine crews cannot be relied upon to give proper attention to matters of this kind.

A boiler compound, the special feature of which is the form in which it is prepared, has been developed by the Paige & Jones Chemical Company, New York. The chemical constituents, mixed with a suitable binder, are put up in hard balls, each about 3 1/4 in. in diameter and weighing one pound. The binder is of such a nature that the material dissolves slowly in cold water. The material is applied to the tender at the terminal and requires no attention whatever on the part of the engine crew. The required number of balls are placed in the tank by the hostler, the actual number depending upon the total amount of water fed to the boiler during the run to which the engine is assigned. As the weight of each ball is one pound, it is a simple matter to count out the required number of pounds and drop them in the tank before the locomotive leaves the roundhouse. The balls dissolve slowly, usually lasting from eight to nine hours. The motion of the engine causes them to roll about the tender, thus facilitating the thorough mixing of the chemicals with the water.

An anti-foam compound which is put up in the same form has also been developed by the same company. The anti-foam balls will last for 20 to 24 hours in cold water, thus eliminating the inconvenience of arranging for the constant application required where compounds put up in liquid form are used.

These compounds are in successful use on several railroads at the present time.

TRIPLE PURPOSE RADIAL DRILL

A radial 6-ft. drill that is adapted to boring operations in addition to the usual work of drilling and tapping, has recently been developed by the American Tool Works Company, Cincinnati, Ohio. This machine has an unusually wide range of spindle speeds. A distinct range of 16 speeds, from 15 to 81 r. p. m., is provided for heavy tapping and boring and a second range of 16 speeds, from 94 to 500 r. p. m., is provided for high speed drilling and light tapping. These speeds are in geometrical progression and the wide range makes possible the boring and high speed drilling operations. The different speeds are obtained through a quadruple geared head in conjunction with eight gear box speeds and is accomplished with only 15 gears.

The machine is provided with a double spindle drive as shown in one of the illustrations. The external gear provides the range of high speeds and the internal gear gives the range of low speeds. With this arrangement the wide range of speeds is obtained without resorting to small pinions or operating the gears at high velocities and without absorbing too much power. It would appear that with such a wide range of speeds there would be excessive gear velocities, but no gear on this machine runs faster than 1,000 ft. per minute for any of the speeds mentioned. The internal gear has a double spline on the spindle and is mounted on ball bearings.

One of the important improvements in this drill is in the tapping attachment. This mechanism is completely enclosed and runs in oil. The gears are of large diameter and are made of tough steel, being provided with bronze bushings. The friction bands are 8 in. in diameter and are adjusted from the outside.

The feeding mechanism is direct-reading, and only one dial is required for its operation. There are eight feeds, ranging in geometrical progression from .005 in. to .04 in.

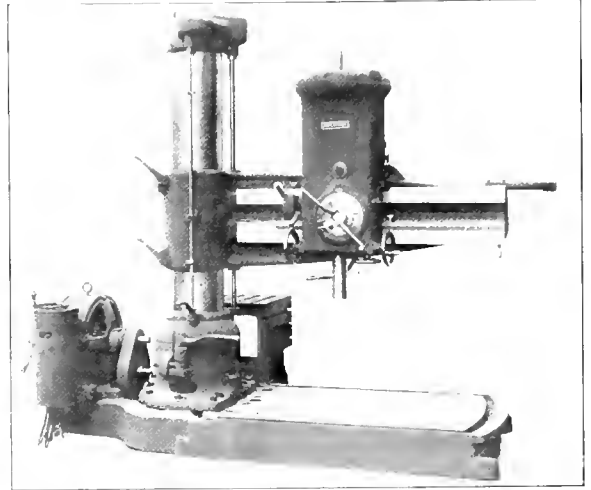

Radial Drill That is Used for Boring Purposes

per spindle revolution. The mechanism is protected against sudden shocks or excessive stress by a friction connection between the mechanism and the spindle. This friction is of the expanding band type, and is quickly adjusted for any desired tension.

The counterweight is completely enclosed by the head casing and is provided with a safety stop which operates

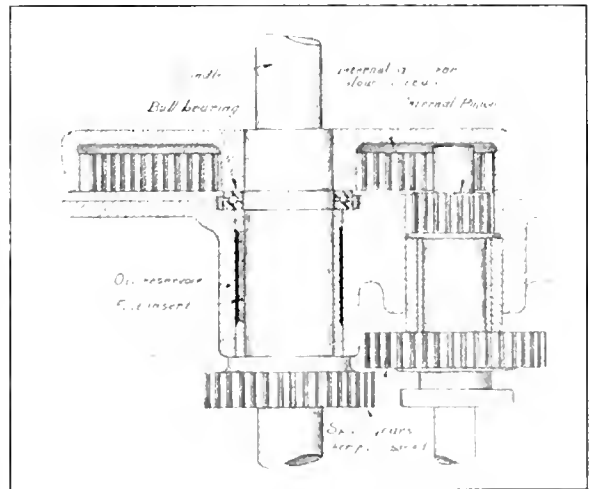

Double Spindle Drive for Triple Purpose Radial Drill

automatically should the supporting chain break. The location of the counterweight near the spindle brings the center of gravity of the head and counterweight close to the head supports on the arm. This facilitates the movement of the head and also gives it a much better balance on the arm. The arm cannot be elevated until the binding levers are

loosened. A safety friction is incorporated in the elevating gears, the slipping point of which is reached long before the resistance of the binders is overcome. This friction also serves another purpose. Whenever the elevating mechanism is engaged, there is a decided shock, which this mechanism absorbs, thereby protecting the shafts and gears. A "knock-out" mechanism on the elevating shaft automatically disengages the mechanism at the extreme upward or downward positions of the arm.

With the exception of a few bronze speed gears, every gear in the machine is steel. The pinions and clashing gears in the speed changing mechanism are heat treated and hardened. All shafts in the head and the gear box are made from crucible steel, while the long vertical and horizontal shafts are made from .45 per cent carbon stock. The bearings are brushed with phosphor bronze throughout and are all renewable. The oil ducts of the various bearings are brought to central locations on the head and cap, thus reducing the number of oil wells which must be given attention to two, and thus insuring a supply of oil to all of the bearings on the machine.

Special attention has been given to simplicity in construction and to convenience in operation. The fact that 32 spindle speeds are obtained with only 15 gears in the speed changing mechanism is especially noteworthy. The regular equipment of the machine includes a plain table, double friction countershafts and cone pulley drive. It may be provided, however, with the speed motor drives above described, a universal table, a power tapping mechanism, a positive arm support and bases designed to suit special requirements. The spindle has a traverse of 20 in. and the arm a traverse on the column of 46 3/4 in. At its highest point the spindle is 6 ft. 6 in. from the base. The traverse of the head on the arm is 63 in. The drill is designed for use with either a constant speed motor and speed box, a variable speed motor connected directly to the horizontal driving shaft at the bottom of the column or a countershaft and cone pulley drive.

REINFORCED SHOE AND WEDGE

A method of reinforcing cast iron shoes and wedges has been patented by J. C. Lyons, McComb, Miss. As shown in the illustration the reinforcement consists of steel plates 3/16 in. to 1/4 in. thick formed so that there will be about 1/4 in. of cast metal between the strips and the engine frame when the castings are finished. Holes punched through the strips tie this metal to the body of the casting. At the corner of

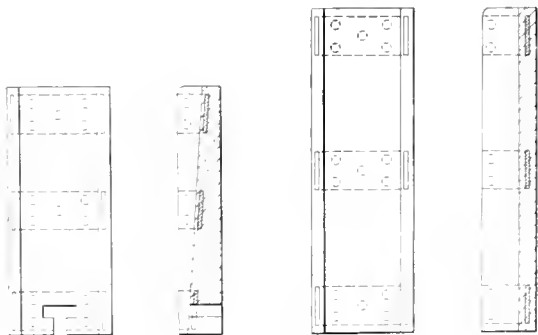

Shoes and Wedges Cast With Steel Reinforcing Strips

the flange, which is the weak point in the casting, the strips are left solid to insure maximum strength and stiffness at this point. The molding of the reinforced castings requires but a small amount of additional time, as the strips are easily placed in the mold.

Since November, 1915, about 100 of the reinforced shoes and wedges have been placed in service on the engines of one division of a southern railroad. The reinforced castings were applied in running repairs in cases where the standard type of shoes and wedges were continually requiring renewal because of broken flanges. So far none of the reinforced shoes or wedges have broken. The reinforcing plates have been found particularly useful in the top part of wedges which are cut away at the top of the flanges for spring equalizers on underhung spring rigging.

WESTINGHOUSE "FIFTY-FOUR" AIR STRAINER

The demands of modern heavy locomotive and car equipment and the much longer trains which are now handled, have required a constantly increasing air supply during the last few years. This has been met by increased air compressor capacity and efficiency. The heavier demand upon the air strainer produced by the increased air compressor capacity has led to the development of a new design of strainer which has recently been brought out by the Westinghouse Air Brake Company, Wilmerding, Pa. The illustrations show the construction and method of attaching the strainer to the compressor.

The prime requirements of an air strainer are adequate capacity and ability to remove all grit or other foreign matter from the air before it reaches the compressor. Without sufficient strainer capacity, the compressor works against the handicap of a comparatively high vacuum at the suction and

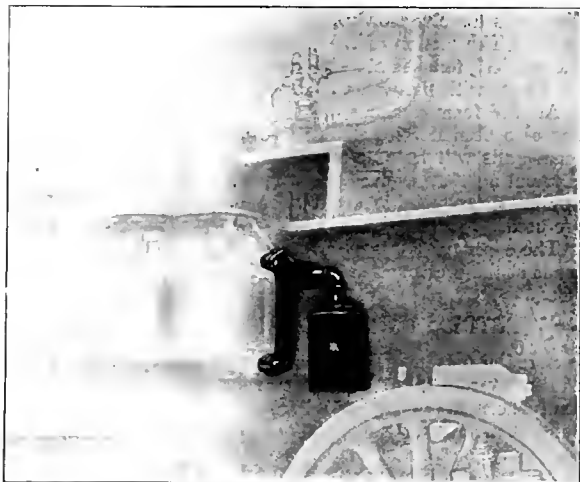

Air Strainer With Manifold Attachment Applied to an 8 1/2-in. Cross-Compound Pump

its capacity is thereby seriously affected. The desirability of thoroughly cleaning the air, from the standpoint of air pump maintenance, is self-evident. If the air carries dust or other foreign matter into the compressor, it not only causes undue cylinder wear, but results in choked air passages and overheating. Dirt is carried through the system, and the effect is felt on other parts of the locomotive equipment as well as the air pump.

To insure thorough cleaning in the new strainer, the air passes through a cylinder of pulled, curled hair. This provides 54 sq. in. of intake screen area, which is large enough to prevent the formation of a high vacuum at the intake port. The relatively low velocity with which the air passes through the screen also facilitates the cleaning of the air. The strainer will run for a long period before cleaning is necessary. When it becomes desirable to renovate the curled

hair, however, the entire strainer is readily removed from the casing.

This strainer is designed primarily for use with the 8½-in. compound compressor, a manifold attachment having been designed so that but one strainer is required. It may be used to advantage, however, on either the 9½-in. or 11-in.



Section Showing the Construction of the Strainer

The crosshead device is centered in the piston rod fit. Before setting it up, however, a hole is drilled through the crosshead, at the location of one end of the keyway, and equal in diameter to the width of the keyway. The device is then set up on the crosshead, as shown in the illustration. The feed screw is run in and a reamer passed through the drilled hole and centered at the top and bottom in the two arms of the device. These arms terminate in hardened tool steel blocks to prevent wear. The reamer is driven by means of an air motor operating at about 250 r.p.m., and the keyway cut by drawing the reamer into the metal with the feed screw. A keyway in a crosshead such as that shown in the illustration can be finished in about 12 minutes.

The piston rod cutter is centered about the body of the rod, the centering sleeve being provided with extension lugs, through which operate the reamer guide rods. The operation of cutting the keyway in the piston rod is performed in the same manner as that in the crosshead. A hole is first drilled at the end of the keyway farthest from the end of the rod and the device set up with the reamer through

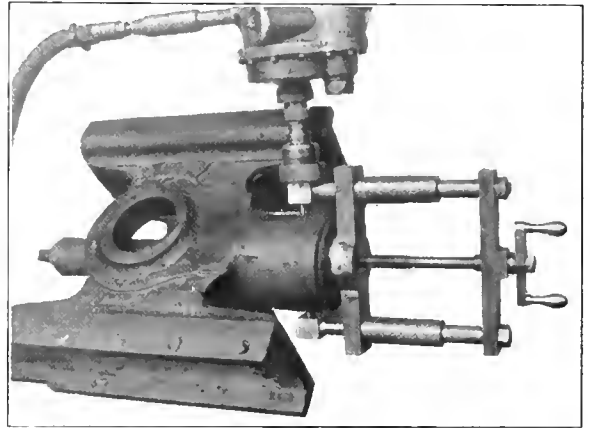

Keyway Cutter Applied to a Crosshead

this hole. After the motor has been attached and started, the reamer is drawn into the metal by the feed screw, the reaction being taken against the end of the piston rod. Piston rod keyways can be cut with this device in from six to fourteen minutes, depending upon the material and the size of the rod.

This device was designed and has been patented by Emmett G. Detrick, machine shop foreman, Yazoo & Mississippi Valley, Vicksburg, Miss.

MILD STEEL FOR LOCOMOTIVE FIRE-BOXES.—The *Zeitschrift des Vereines Deutscher Ingenieure* of September 9, 1916, contained an article on the use of mild steel for locomotive fire-boxes, by Dr. Kittel, dealing particularly with tests conducted in the Technical High School at Stuttgart, with a very pure iron, a speciality of Krupp's works. This iron showed little of the critical temperature range, during which steels are apt to fail. In the issue of the same journal of November 25, Director Busse, of the Danish State Railway department, commenting on this article, says that he introduced mild steel fire-boxes 20 years ago, taking first American and then Krupp steel; the latter had answered better than the former. The tubes were expanded into the boxes with the aid of copper ferrules. Visiting the United States lately he had observed that repairs of fire-boxes were tolerated which European practice would hardly pass, and that on the whole, perhaps, the life of a fire-box depended more upon the way in which it was built and treated than upon the material.—*Engineering* (London).

pump. The piping is arranged for close connection, but if desired, it may be run off to an isolated and more protected location. The strainer is tapped for a two-inch pipe, but may be fitted with a reducer for use on the smaller compressors.

PORTABLE PISTON ROD AND CROSSHEAD KEYWAY CUTTER

A simple device for cutting keyways in crossheads and piston rods is shown in the drawing. It is especially convenient for use in a small shop where machine tool facilities are limited. Two of these tools are required, one for cross-

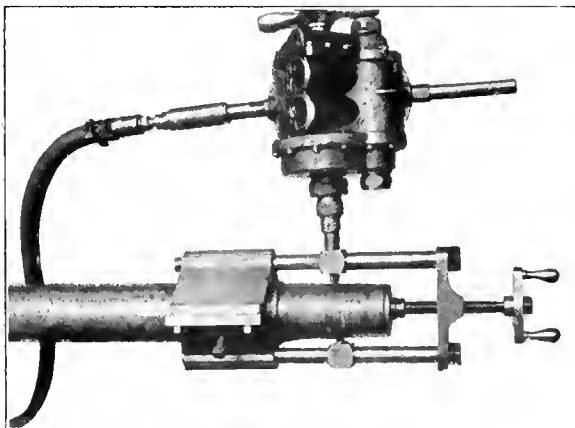

Piston Rod Keyway Cutter

heads and one for piston rods. Both operate on the same principle, but the difference in the shape of the pieces necessitates a slightly different construction for the two classes of work.

Railway Mechanical Engineer

(Formerly the RAILWAY AGE GAZETTE, MECHANICAL EDITION
with which the AMERICAN ENGINEER was incorporated)

PUBLISHED ON THE FIRST THURSDAY OF EVERY MONTH BY THE
SIMMONS BOARDMAN PUBLISHING COMPANY

EDWARD A. SIMMONS, *President* L. B. SHERMAN, *Vice-President*
HENRY LEE, *Vice-President and Treasurer* M. H. WIUM, *Secretary*
WOOLWORTH BUILDING, NEW YORK, N. Y.
F. H. THOMPSON, *Business Manager*, CHICAGO.

Chicago: Transportation Bldg. Cleveland: Citizens' Bldg.
Washington: Home Life Bldg.
London: Queen Anne's Chambers, Westminster.

ROY V. WRIGHT, *Editor*
R. E. THAYER, *Managing Editor*

C. B. PECK, *Associate Editor* A. F. STUEBING, *Associate Editor*

Entered at the Post Office at New York, N. Y., as mail matter of the second class.

Subscriptions, including the eight daily editions of the *Railway Age Gazette* published in June in connection with the annual conventions of the Master Car Builders' and American Railway Master Mechanics' Associations, payable in advance and postage free: United States, Canada and Mexico, \$2.00 a year; Foreign Countries (excepting daily editions), \$3.00 a year; Single Copy, 20 cents.

WE GUARANTEE, that of this issue 8,925 copies were printed; that of these 8,925 copies, 7,805 were mailed to regular paid subscribers, 111 were provided for counter and news companies' sales, 271 were mailed to advertisers, 156 were mailed to exchanges and correspondents, and 582 were provided for new subscriptions, samples, copies lost in the mail and office use; that the total copies printed this year to date were 44,897, an average of 8,979 copies a month.

The RAILWAY MECHANICAL ENGINEER is a member of the Associated Business Papers (A. B. P.) and of the Audit Bureau of Circulations (A. B. C.).

VOLUME 91

MAY, 1917

NUMBER 5

CONTENTS

EDITORIALS:		Recentering Car Axles.....	256
Shop Equipment Number.....	227	Interchange Inspection Problems.....	256
The Grain Car Situation.....	227	SHOP PRACTICE:	
Mechanical Conventions Postponed.....	227	Shoe and Wedge Job.....	257
The Railroads and the War.....	227	Reinforcing Wear in Drawing Box Cellar Bolt Holes.....	258
Locomotive Brick Arch Tests.....	228	Boiler Patches for Locomotives.....	259
Routing Work in Railroad Shops.....	228	Work Distribution in the Roundhouse.....	262
The Railway Equipment Situation.....	229	Rabbiting Valve Rod Crossheads.....	262
Readjustment to Present Conditions.....	229	Assisting Shrinkage in Autogenous Welding by Mechanical Means.....	263
New Books.....	230	Vaporizer for Burning Kerosene.....	263
COMMUNICATIONS:		Novel Use for Car Wheel Borer.....	264
What Is an Engine Failure?.....	230	Staybolt Holder-On With Automatic Recoil.....	264
GENERAL:		"Cleaning up" Muncie Roundhouse.....	265
New Power for the Lehigh Valley.....	231	Locating Defective Safety Valves.....	267
Locomotive Brick Arch Tests.....	235	Air Hose Connection for Pits.....	268
Saving Effected by Breaking Scrap.....	237	Portable Flue Cutter.....	268
Prompt Action by the Railways in the War.....	238	Emergency Repairs to Straight Air Brake Valve.....	268
McClellon Water-Tube Firebox.....	239	NEW DEVICES:	
Firing Engines at Engine Houses.....	242	Foster Universal Turret Lathe.....	269
Economics of the Shop Lower House.....	243	Automatic Dry Graphite Cylinder Lubricator.....	270
CAR DEPARTMENT:		Elliptical Grate Bar.....	270
Air Brake Lever Computations.....	245	A Convenient Method of Boiler Feed Water Treatment.....	271
Co-Operation of All Roads Needed to Reduce Hot Boxes.....	246	Triple Purpose Radial Drill.....	271
Resistance of Passenger Cars.....	247	Reinforced Shoe and Wedge.....	272
Prevent Hot Boxes by Education.....	249	Westinghouse "Fifty-four" Air Strainer.....	272
The Chilled Iron Car Wheel.....	249	Portable Piston Rod and Cross-head Keyway Cutter.....	273
Derailment Due to Defective Equipment.....	251	NEWS DEPARTMENT:	
Box Car Side Door.....	252	Notes.....	274
The Car Department Apprentice.....	253	Meetings and Conventions.....	276
Steel Gondola versus Composite Gondola.....	253	Personal Mention.....	277
Interest the Men in Hot Boxes.....	254	Supply Trade Notes.....	279
Co-Operation Between Yard and Car Repair Forces.....	255	Catalogues.....	282

The passenger car shop of the Southern Railway at Meridian, Miss., was destroyed by fire on the night of April 15; estimated loss, \$100,000.

The Baltimore & Ohio, the Pennsylvania and the Western Maryland have combined to provide a hospital train for the use, when needed, of Maryland soldiers. The train is being fitted up at the shops of the Western Maryland.

The Boston & Albany has made an advance of 5 per cent in the pay of all classes of employees who are not subject to the Adamson law, excepting those receiving \$150 or more monthly. It is estimated that this will increase the annual payrolls about \$250,000.

The shops of the Pullman Company, Pullman, Ill., have just completed a "service car" for the Department of Public Health of the United States government. The car is to be used by chemists who are to travel around the country to

analyze drinking water supplied to passengers by the railroads.

C. R. Richards, professor of mechanical engineering of the University of Illinois and head of that department since 1911, has been appointed dean of the college of engineering and director of the engineering experiment station, to succeed W. F. M. Goss, who recently resigned to become president of the Railway Car Manufacturers' Association of New York.

The Great Northern has issued bulletins to its employees stating that all of its men enlisting in the army and navy of the United States will have their positions restored to them upon returning from such service, and also that all seniority and pension rights will be retained. The Northern Pacific has issued similar bulletins from the office of the vice-president.

Instructions have been issued from the office of the presi-

dent of the St. Louis-San Francisco to fly an American flag on each locomotive in service on the entire system. The stars and stripes, in addition, will be put on all station buildings along the line. Flags are to be furnished by the company, although it is stated that the idea originated with the employees themselves.

ORGANIZATION OF A MILITARY RAILWAY REGIMENT

A military railway regiment to assist the army by the construction and operation of railways in connection with military movements is now being organized under the direction of S. M. Felton, president of the Chicago Great Western at Chicago. The new organization will consist of one company each from the following Chicago railroads: The Illinois Central, the Chicago Great Western, the Chicago & North Western, the Chicago, Milwaukee & St. Paul, the Chicago, Rock Island & Pacific and the Atchison, Topeka & Santa Fe. Several months previous to the declaration of war Mr. Felton, who was appointed consulting engineer and adviser to the chief of engineers of the United States Army at the time of threatened hostilities on the Mexican border, was directed to perfect plans for the formation of the new army unit.

Simultaneously with the entrance of the United States into the war, steps were taken to form the regiment. Each railway is furnishing one company of which the captain will be a division superintendent, the lieutenants a chief despatcher, an engineer maintenance of way, a road foreman of engines, and a trainmaster or master mechanic, and the remaining 164 men will be recruited from all branches of railroad service. Non-commissioned officers will be drawn from men of the rank of track supervisors, bridge supervisors, roundhouse foremen, assistant engineers, section foremen, bridge foremen, etc. Among the employees desired to fill the ranks are those holding such positions as conductors, brakemen, yard foremen, despatchers, track foremen, electricians, bridge and building foremen, car inspectors, wrecking foremen, storekeepers, traveling engineers, roundhouse foremen, locomotive engineers and firemen, stationary enginemen, switchmen, oilers, machinists, operators, yardmasters, pumpmen, linemen, locomotive inspectors, boiler makers, blacksmiths, stenographers, surveyors, car repairers, clerks, carpenters, masons, pile driver men, plumbers, agents, etc. In addition to four commissioned officers for each company, consisting of a captain and three lieutenants, the railways will furnish two majors, two captain adjutants, one captain quartermaster, and one captain engineer. The colonel, the lieutenant colonel and his captain adjutant will be regular army officers.

Each company will be expected to be capable of taking over a section of railroad of approximately 100 miles in length and to operate it in the same manner that it might handle the work of a division on its own line. The engineering officers of each unit are also expected to be prepared to handle expeditiously the construction of any lines that military operations may necessitate. Those enlisting become members of the United States Engineer Enlisted Reserve Corps, while those commissioned as officers are admitted to the United States Engineer Officers Reserve Corps as provided for in the National Defense Act of June 3, 1916.

NO LABOR DISPUTES DURING THE WAR

The Council of National Defense has adopted a report of its labor committee, of which Samuel Gompers, president of the American Federation of Labor, is chairman, recommending that the council shall issue a statement to employers and employees in industrial plants and transportation systems advising that neither employers nor employees shall endeavor to take advantage of the country's necessities to change existing standards of wages and working conditions. It is recommended that when economic or other emergencies arise requiring changes of standards, the same should be made only

after such proposed changes have been investigated and approved by the Council of National Defense. It was also recommended that the council urge upon the legislatures of the states that before final adjournment they delegate to the governors of the respective states power to suspend or modify restrictions contained in their labor laws when requested by the Council of National Defense for a specified period, not to exceed the duration of the war. The labor committee includes Warren S. Stone, grand chief of the Brotherhood of Locomotive Engineers, and Elisha Lee, general manager of the Pennsylvania Railroad.

TRADE JOURNALS DECLARE FOR UNIVERSAL SERVICE

The New York Business Publishers' Association, composed of the trade and technical journals in New York, unanimously adopted resolutions at its monthly meeting on April 23, indorsing universal military training and service, and pledging its support to the government in the sale of bonds necessary to carry on the war.

The editorial conference of the New York Business Publishers' Association, Inc., has also pledged its support. An offer to the government by 277 class journals of the United States to give editorial co-operation and free advertising space to support government activities in connection with the war was made last week. The telegrams offering this co-operation were taken to Washington on April 17 by Arthur J. Baldwin, vice-president, McGraw-Hill Publishing Company, and A. C. Pearson, secretary of the United Publishers' Corporation. They were received by Secretary Daniels of the Navy Department; George Creel, the recently appointed head of the Board on Censorship and Publicity; Grosvenor B. Clarkson, secretary of the Council of National Defense, and Howard E. Coffin, of the Advisory Board to the Council. The *Railway Mechanical Engineer* and all other Simmons-Boardman papers are members of the New York Business Publishers' Association, Inc., and of the editorial conference.

CAR AND LOCOMOTIVE ORDERS IN APRIL

In April this year, as in last, the orders for cars and locomotives fell off slightly from the level set in the earlier months of the year. That this year's orders have held up as well as they have in the uncertainty following upon the declaration of war, however, is gratifying. The totals for the month were as follows:

	Locomotives	Freight cars	Passenger cars
Domestic	240	3,623	40
Foreign	84	—	—
Total	324	3,623	40

The locomotive orders included the following:

Buffalo, Rochester & Pittsburgh	10 Mallet	American
	5 Pacific	American
	4 Switching	American
Canadian Government Railways	30 Mikado	American
	10 Pacific	American
	10 Santa Fe	American
Chicago & North Western	50 Mikado	American
Pere Marquette	15 Santa Fe	American
	6 Switching	American
Russian Government	53 Narrow gage	Mallet
	60 Decapod	Baldwin
South African Railways	8 Mallet	American
	10 Mountain	American

Among the important freight car orders was the Philadelphia & Reading's order for 2,000 cars divided as follows: 500 gondola, Standard Steel Car Company; 500 gondola, Pressed Steel Car Company; 500 box, American Car & Foundry Company and 500 box, Pullman Company.

The Chicago, Milwaukee & St. Paul ordered 20 baggage cars from the Standard Steel Car Company and the Great Northern, 20 baggage and mail cars from the American Car & Foundry Company.

MEETINGS AND CONVENTIONS

Boiler Makers' Supply Men's Association.—The executive committee of the supply manufacturers' organization which meets in conjunction with the Master Boiler Makers' Association has decided not to hold an exhibit this year.

Railway Supply Manufacturers' Association.—E. H. Walker, president of the Railway Supply Manufacturers' Association on April 18 announced to the members that the convention of that association, which was to have been held at Atlantic City, N. J., June 13 to 20, has been postponed for one year. This action was taken after a general expression of opinion of the members, who feel that their time and resources should be conserved for the better service of the country in meeting the extraordinary demands arising from our entrance into the war.

St. Louis Railway Club.—The annual election of the St. Louis Railway Club took place at the American Annex hotel, St. Louis, on April 13. The following officers were elected for the coming year: President, M. O'Brien, master mechanic, United Railways of St. Louis; first vice-president, W. S. Williams, division superintendent, Illinois Central, Chicago, Ill.; second vice-president, J. A. Somerville, general superintendent of transportation, Missouri Pacific-St. Louis, Iron Mountain & Southern; third vice-president, F. W. Green; secretary-treasurer, B. W. Frauenthal, ticket agent, Union Station, St. Louis.

Pacific Railway Club.—The Pacific Railway Club was organized in San Francisco, Cal., on March 1. The club was formed after a letter ballot had been taken of all railway officers in the cities about San Francisco bay to determine whether there was a general need of a forum where matters relating to railway construction, operation and maintenance might be presented and discussed. As the ballot was preponderantly in favor of such an organization a meeting was held to effect its formation, and 86 charter members, including employees of 10 railroads and the professors of railroad engineering and economics of the University of California and Leland Stanford University, were taken in. The officers elected for the club's first year are: President, A. H. Babcock, consulting electrical engineer, Southern Pacific; first vice-president, G. H. Binkley, valuation engineer, United Railways of San Francisco; second vice-president, P. P. Hastings, assistant general freight agent, Atchison, Topeka & Santa Fe; treasurer, B. W. Perrin, division engineer, suburban lines, Southern Pacific; secretary, W. S. Wollner, assistant to the chief engineer, Northwestern Pacific.

Interchange Car Inspectors' and Car Foremen's Supply Men's Association.—During the past few years numerous manufacturers of railway supplies and appliances have arranged exhibits at the time of the annual conventions of the Chief Interchange Car Inspectors' and Car Foremen's Association. In order to facilitate the work for the companies desiring to make exhibits at that time, a permanent organization has been formed which will be known as the Interchange Car Inspectors' and Car Foremen's Supply Men's Association.

At a meeting held at the Hotel La Salle, Chicago, on April 9, a constitution and by-laws were drawn up and the following officers were elected: President, L. S. Wright, National Malleable Castings Company; first vice-president, C. D. Derby, Joyce-Cridland Company; second vice-president, W. G. Wilcoxson, Boss Nut Company; secretary, D. B. Wright, the Lehon Company; treasurer, J. R. Mitchell, with W. H. Miner. The executive committee of the association is to be made up of nine representatives of supply companies, three to be elected each year for a term of three years, and the secretary of the Chief Interchange Car Inspectors' and Car Foremen's Association. The following were elected members of the executive committee for three years: W. G. Wallace, American Steel Foundries; C. N. Thulin, Duff Manufacturing Company; D. B. Sissons, Imperial Appliance Company. The members elected for two years are: C. J. W. Clasen, the Bettendorf Company; C. J. Wymer, the Grip Nut Company; W. H. Pratt, Heath & Milligan; and the following were elected for one year: A. H. Beatty, Templeton-Kenly & Co.; J. E. Tareton, Union Draft Gear Company; D. F. Jennings, of Guilford S. Wood.

The following list gives names of secretaries, dates of next or regular meetings and places of meeting of mechanical associations:

- AIR BRAKE ASSOCIATION.—F. M. Nellis, Room 3614, 165 Broadway, New York City. Convention, May 1-4, 1917, Memphis, Tenn.
- AMERICAN RAILROAD MASTER TINNERS', COPPERSMITHS' AND PIPEFITTERS' ASSOCIATION.—O. E. Schlink, 485 W. Fifth St., Peru, Ind. Convention, June 26-29, 1917, Marquette Hotel, St. Louis, Mo.
- AMERICAN RAILWAY MASTER MECHANICS' ASSOCIATION.—J. W. Taylor, Karpen Building, Chicago. Convention postponed.
- AMERICAN RAILWAY TOOL FOREMEN'S ASSOCIATION.—R. D. Fletcher, Belt Railway, Chicago. Convention, August 30, 31 and September 1, 1917, Hotel Sherman, Chicago.
- AMERICAN SOCIETY FOR TESTING MATERIALS.—Prof. E. Marburg, University of Pennsylvania, Philadelphia, Pa.
- AMERICAN SOCIETY OF MECHANICAL ENGINEERS.—Calvin W. Rice, 29 W. Thirty-ninth St., New York.
- ASSOCIATION OF RAILWAY ELECTRICAL ENGINEERS.—Joseph A. Andreuccetti, C. & N. W., Room 411, C. & N. W. Station, Chicago.
- CAR FOREMEN'S ASSOCIATION OF CHICAGO.—Anton Khine, 841 Lawlor Ave., Chicago. Second Monday in month, except June, July and August, Hotel La Salle, Chicago.
- CHIEF INTERCHANGE CAR INSPECTORS' AND CAR FOREMEN'S ASSOCIATION.—W. R. McMunn, New York Central, Albany, N. Y. Convention, September 25, 26 and 27, 1917, St. Louis, Mo.
- INTERNATIONAL RAILROAD MASTER BLACKSMITHS' ASSOCIATION.—A. L. Woodworth, C. H. & D. Lima, Ohio. Convention, August 21, 1917, Hotel Sherman, Chicago.
- INTERNATIONAL RAILWAY FUEL ASSOCIATION.—J. G. Crawford, 547 W. Jackson Blvd., Chicago. Convention, May, 1917, Chicago.
- INTERNATIONAL RAILWAY GENERAL FOREMEN'S ASSOCIATION.—William Hall, 1126 W. Broadway, Winona, Minn. Convention, September 4-7, Hotel Sherman, Chicago, Ill.
- MASTER BOILERMAKERS' ASSOCIATION.—Harry D. Vought, 95 Liberty St., New York. Convention, May 22-25, 1917, Richmond, Va.
- MASTER CAR BUILDERS' ASSOCIATION.—J. W. Taylor, Karpen Building, Chicago. Convention postponed.
- MASTER CAR AND LOCOMOTIVE PAINTERS' ASSOCIATION OF U. S. AND CANADA.—A. P. Dine, B & M, Reading, Miss. Convention, September 11, 1917, Hotel La Salle, Chicago.
- NIAGARA FRONTIER CAR MEN'S ASSOCIATION.—E. N. Frankenburg, 623 Brisbane Building, Buffalo, N. Y. Meetings, third Wednesday in month, New York Telephone Bldg., Buffalo, N. Y.
- RAILWAY STOREKEEPERS' ASSOCIATION.—J. P. Murphy, Box C, Collinwood, Ohio. Convention, May 21-23, 1917, Chicago, Ill.
- TRAVELING ENGINEERS' ASSOCIATION.—W. O. Thompson, N. Y. C. R. R., Cleveland, Ohio.

RAILROAD CLUB MEETINGS

Club	Next Meeting	Title of Paper	Author	Secretary	Address
Canadian	May 8, 1917	Annual Meeting, Smoker and Entertainment	J. E. Boers	James Powell	P. O. Box 7, St. Lambert, Que.
Central	May 11, 1917	Lubrication of Freight Car Equipment	H. W. Behnap	Harry D. Vought	95 Liberty St., New York
Cincinnati	May 8, 1917	The Safety Appliance Standards, Purposes and Reasons for Location	H. W. Behnap	H. Bontet	101 Carew Bldg., Cincinnati, Ohio
New England	May 8, 1917	Wheels and Rails	Wm. Cade	Wm. Cade	683 Atlantic Ave., Boston, Mass.
New York	May 18, 1917	Iron Car Wheel	George W. Lyndon	Harry D. Vought	95 Liberty St., New York
Pittsburgh	May 23, 1917	Korea, Moving Picture	J. B. Anderson	George W. Lyndon	207 Penn Station, Pittsburgh, Pa.
Richmond	May 14, 1917	Safety Appliance Standards; Moving Picture, "King of the Rails"	H. W. Behnap	E. O. Robinson	C. & O. Railway, Richmond, Va.
St. Louis	May 11, 1917	Annual Meeting	H. W. Behnap	R. W. Frauenthal	Union Station, St. Louis, Mo.
Southern & S.W.	May 19, 1917	Annual Meeting	A. J. Merrill	A. J. Merrill	Box 1265, Atlanta, Ga.
Western	May 21, 1917	Annual Meeting	J. W. Taylor	J. W. Taylor	1112 Karpen Bldg., Chicago

PERSONAL MENTION

GENERAL

WALTER ALEXANDER, chairman of the Railroad Commission of Wisconsin, has been appointed superintendent of motive power of the Chicago, Milwaukee & St. Paul, with office at Milwaukee, Wis., succeeding A. E. Manchester, promoted to general superintendent.



W. Alexander

Mr. Alexander was born in Glasgow, Scotland, in 1872, and was brought to this country in 1873. He received a common school education in Milwaukee, and served an apprenticeship as a machinist and draftsman with the St. Paul, later being employed as a fireman on the same road. He entered the University of Wisconsin in 1893, and graduated from the

course in mechanical engineering in 1897, receiving a second degree in engineering the following year. For three years he was an instructor in engineering at the University of Wisconsin, one year at Armour Institute and one at the University of Missouri. He then returned to railway work as assistant district master mechanic of the St. Paul at Minneapolis, Minn. Two years later he was transferred to Milwaukee, Wis., to a similar position, and later was promoted to district master mechanic at that point. He became a member of the Wisconsin Railroad Commission of Wisconsin in February, 1915, and in August, 1916, was appointed chairman to succeed Halford Erickson.

DANIEL P. KELLOGG, has been appointed superintendent of motive power for the Southern Pacific, with headquarters at Sacramento, Cal., as announced in these columns last month.



D. P. Kellogg

He was born at Alliance, Ohio, April 17, 1869. In June, 1889, he entered railway service as a machinist apprentice with the Missouri Pacific in Kansas. During 1892 he was engaged in installing machinery in contract shops in Utah and the following year was appointed roundhouse foreman for the Chicago, Milwaukee & St. Paul in Wisconsin. From 1896 to 1897 and during part of 1898 he was assistant general foreman of the Duluth & Iron Range at Two

Harbors, Minn., being then appointed air brake inspector for the Southern Pacific at Oakland, Cal. In the latter part of 1898 he was promoted to general foreman of locomotives for this company, and in 1904 was transferred to Bakersfield,

Cal., with the title of master mechanic. From 1906 to 1910 he was master mechanic at Los Angeles, Cal., and he was then advanced to superintendent of shops with the same headquarters, which latter position he continued to fill up to March 1, 1917, when his present appointment became effective.

R. C. BARDWELL, chemist of the Missouri Pacific at Kansas City, has been promoted to assistant engineer in charge of water treatment of the Missouri Pacific and the St. Louis, Iron Mountain & Southern, with headquarters at St. Louis, Mo.

W. J. EDDY, master mechanic of the Chicago, Rock Island & Pacific at El Dorado, Ark., has been appointed superintendent of fuel economy. The engineer of fuel economy and the supervisor of stationary plants will report to him.

J. E. MCQUELLEN, mechanical superintendent of the Gulf, Colorado & Santa Fe, with office at Cleburne, Tex., has had his headquarters moved to Galveston, Tex.

E. F. THOMSON, chief clerk to the president of the Chicago, Indianapolis & Louisville at Chicago, Ill., has been appointed assistant to the superintendent of motive power at Lafayette, Ind.

MASTER MECHANICS AND ROAD FOREMEN OF ENGINES

D. S. BAALS, assistant trainmaster and road foreman of engines of the Chesapeake & Ohio, at Cane Fork, W. Va., has been transferred in the same capacity to the Big Sandy division, with headquarters at Paintsville, Ky., succeeding M. B. Daniels assigned to other duties.

A. H. BINNS has been appointed acting master mechanic on the Trenton division, Ontario district, Canadian Pacific, with office at Trenton, succeeding T. H. Hamilton, transferred temporarily.

E. J. BUCKLEE, master mechanic of the Cleveland, Cincinnati, Chicago & St. Louis at Mt. Carmel, Ill., has been transferred to Mattoon, Ill., succeeding J. J. Karibo, transferred.

JOSEPH F. DONELLAN has been appointed master mechanic of the Pennsylvania division of the Delaware & Hudson, with office at Carbondale, Pa., succeeding George S. Graham, resigned.

W. H. DYER, master mechanic of the Georgia & Florida, at Douglas, Ga., has had his jurisdiction extended over the Augusta Southern.

J. L. JAMIESON, heretofore road foreman of locomotives of the Canadian Pacific at Medicine Hat, Alta., has been appointed road foreman of locomotives at Ignace, Ont.

ALBERT H. KENDALL, formerly master mechanic of the Canadian Pacific, Ontario district, has been appointed captain, No. 1 Section, Skilled Railway Employees, recently organized to operate 300 miles of double track railway which is now completed in the northern part of France. Mr. Kendall's photograph and a sketch of his career were published in the *Railway Mechanical Engineer* for December, 1916.

C. L. SHARP, general foreman of locomotives, Chicago, Rock Island & Pacific, at Shawnee, Okla., has been appointed master mechanic of the Louisiana division at El Dorado, Ark., succeeding W. P. Eddy, promoted.

D. M. SMITH, heretofore road foreman of locomotives of the Canadian Pacific at Kenora, Ont., has been appointed road foreman of locomotives at Medicine Hat, Alta., succeeding J. L. Jamieson, transferred.

G. P. TRACHLA, road foreman of engines of the Chicago, Burlington & Quincy at McCook, Neb., has been appointed

master mechanic at Casper, Wyo., succeeding J. O. McArthur, transferred.

A. R. THOMPSON has been appointed road foreman of engines of the Chesapeake & Ohio, with headquarters at Cane Fork, W. Va., succeeding D. S. Baals transferred.

CAR DEPARTMENT

A. E. CHESTERMAN, heretofore car foreman of the Canadian Pacific at Crowsnest, B. C., has been appointed car foreman at Field, B. C., succeeding A. E. Tasker, transferred.

JAMES HALL, formerly master car repairer of the Southern Pacific, on the Coast division, at San Francisco, Cal., has been appointed general foreman of passenger cars in charge of repairs and construction, at Sacramento, Cal.

C. W. MCCLEAR, heretofore coach carpenter of the Canadian Pacific at Vancouver, B. C., has been appointed car foreman at Crowsnest, B. C., succeeding A. E. Chesterman, transferred.

W. PEAT, heretofore car foreman of the Megantic division, Quebec district of the Canadian Pacific, at Megantic, Que., has been transferred to the Western lines with headquarters at Vancouver, B. C.

A. E. TASKER, car foreman of the Canadian Pacific at Field, B. C., has been appointed car foreman at Winnipeg, Man.

SHOP AND ENGINEHOUSE

D. E. BARTON has been appointed acting superintendent of shops of the Atchison, Topeka & Santa Fe at Albuquerque, N. M., succeeding W. A. George, granted leave of absence.

WILLIAM R. DOWNS, formerly foreman boiler maker at the Avis shops of the New York Central, has been appointed assistant general foreman at that point.

JOHN FRASER has been appointed locomotive foreman of the Grand Trunk at Edmundston, N. B., succeeding C. White, transferred.

J. MCGOWAN, formerly locomotive foreman of the Canadian Pacific at Rogers Pass, B. C., has been appointed locomotive foreman at Strathcona, Alta., succeeding G. Pratt transferred. The position of locomotive foreman at Rogers Pass has been abolished, owing to the placing in operation of the Connaught tunnel.

H. E. OPLINGER, general foreman of the Atlantic Coast Line at Brunswick, Ga., has been transferred to Charleston, S. C., in the same position, to succeed M. L. Gray, who has resigned.

G. PRATT, locomotive foreman of the Canadian Pacific at Strathcona, Alta., has been appointed locomotive foreman at Medicine Hat, Alta., succeeding J. Perry, assigned to other duties.

O. B. SCHOENKY, superintendent of shops of the Southern Pacific at Sacramento, Cal., has been transferred to Los Angeles, as superintendent of shops at that point, succeeding D. P. Kellogg, promoted.

C. WHITE, locomotive foreman of the Canadian Government Railways at Edmundston, N. B., has been appointed locomotive foreman at Napadogan, N. B., succeeding W. C. Williams.

PURCHASING AND STOREKEEPING

FRANK S. AUSTIN has been appointed general storekeeper of the Boston & Albany, with headquarters at West Springfield, Mass. He was born on November 6, 1886, at Lynn, Mass., and attended Ingalls Grammar School, also the English High School of his native city and graduated from Dartmouth College in 1909. The same year he began rail-

way work with the Boston & Albany, and has been in the continuous service of that road ever since. He served as assistant to the supervisor of track at Pittsfield, Mass., until 1911, and then for two years in the same capacity at Springfield. In 1915 he was appointed supervisor of track at Worcester, and three years later became supervisor of track at Boston, which position he held at the time of his recent appointment as general storekeeper.

P. E. BAST, fuel inspector of the Delaware & Hudson at Colonie, N. Y., has been appointed fuel agent, with office at Albany, N. Y.

S. G. DENMAN, heretofore assistant purchasing agent of the Canadian Pacific at Vancouver, B. C., has been appointed assistant purchasing agent at Calgary, Alta., succeeding J. T. H. Ferguson, transferred to Vancouver.

J. T. H. FERGUSON, heretofore assistant purchasing agent of the Canadian Pacific at Calgary, Alta., has been appointed assistant purchasing agent at Vancouver, B. C., succeeding S. G. Denman, transferred to Calgary, Alta.

C. F. LUDINGTON, chief fuel supervisor of the Atchison, Topeka & Santa Fe, at Topeka, Kan., has resigned to accept a similar position with the Missouri, Kansas & Texas, with headquarters at Parsons, Kan.

F. MCDOWELL, heretofore general foreman of the Winnipeg stores of the Canadian Northern has been appointed storekeeper, with jurisdiction over all matters regarding Winnipeg stores. He reports to the general storekeeper. His office is at Winnipeg, Man.

S. W. SAYE, purchasing agent of the Georgia & Florida at Augusta, Ga., has had his authority extended over the Augusta Southern.

C. T. WINKLESS has been appointed superintendent of fuel of the Chicago, Rock Island & Pacific, with headquarters at Chicago, Ill. He will have charge of fuel purchase, distribution and handling.

OBITUARY

MICHAEL J. McANDREW, traveling engineer of the Michigan Central, Canadian lines, died suddenly in the office of the roundhouse at Victoria, Ont., on March 20, 1917.

GEORGE H. PRICE, chief car inspector of the Nashville, Chattanooga & St. Louis, at Chattanooga, Tenn., died at his home in Chattanooga on March 31, 1917.

GEORGE WOOLLEY STRATTAN, retired master mechanic of the Altoona machine shops of the Pennsylvania Railroad, died at Easton, Pa., on April 14, 1917. Mr. Strattan was born in Philadelphia, Pa., on January 26, 1836, but subsequently lived in New York where his education was completed. He worked as a clerk for a short time, but on May 15, 1858, entered the works of William Sellers & Company as a machinist apprentice. After completing his apprenticeship he came to Altoona on March 14, 1861, entering the service of the Pennsylvania Railroad. On January 28, 1863, he went with the Freedom Iron Company at Lewistown, Pa., but on September 22, 1864, he returned to Altoona and again became connected with the Pennsylvania Railroad. Early in 1865 he was made a gang foreman and on March 3, 1867, he was advanced to assistant master mechanic of the Altoona machine shops. On October 1, 1870, he was promoted to the position of master mechanic, which he held until his retirement on January 31, 1906. When he was made master mechanic he had about 1,000 men under his direct control; when he retired, the workmen numbered about 5,600. In addition to having charge of the Altoona machine shops, he was in charge of the East Altoona, Hollidaysburg, Huntingdon and Mifflin shops, and other points along the Middle division.

SUPPLY TRADE NOTES

Henry B. Oatley, chief engineer of the Locomotive Superheater Company, has been called to active duty as a lieutenant in the New York naval reserves.

B. John Buell, formerly with the Spencer Otis Company of Chicago, has been appointed general manager of the Reading Specialties Company, Reading, Pa.

The Pullman Company on May 1 will move its New York offices from the Mills building, 15 Broad street, to room 2612 in the Adams Express building at 61 Broadway.

A. C. Loudon, formerly managing editor of the *Railway Mechanical Engineer*, has joined the staff of the Locomotive Superheater Company, 30 Church street, New York.

The Pyle-National Company, Chicago, announces that after April 8, 1917, its general offices will be located at 1334 North Kostner avenue, Chicago, instead of 900 South Michigan avenue, as heretofore.

K. J. Eklund, assistant to the president of the Pilliod Company, with office at New York, has been transferred to the Chicago office as assistant to Burton W. Mudge, president of Mudge & Co. and vice-president of the Pilliod Company.

H. S. Mikesell, assistant manager, mining department of the Chicago, Rock Island & Pacific, has resigned to become vice-president and treasurer of Mikesell Brothers, Chicago, Ill., manufacturers of asbestos lining, packings and brake linings.

Don B. Sebastian, fuel agent of the Chicago, Rock Island & Pacific, has resigned to become associated with the Bickett Coal & Coke Company, Chicago, Ill. Mr. Sebastian will be elected a vice-president of the company at its next annual meeting.

J. M. Borrowdale, formerly superintendent of car construction for the Illinois Central, with office at Chicago, Ill., has been appointed car specialty representative of the general railroad department of the H. W. Johns-Manville Company, Chicago.

Leon P. Alford, editor of the *American Machinist* for the past 10 years, has recently become associated with Industrial Management, formerly *Engineering Magazine*, as editor-in-chief. He has been succeeded as editor of the *American Machinist* by John H. Van Deventer.

The Rome Merchant Iron Mill, of Rome, N. Y., has been reincorporated under the name of Rome Iron Mills, Inc. This change was made to provide for an increased capitalization necessitated by a large increase in facilities for the manufacture of hollow staybolt iron. There has been no change in the management.

The Louisville Car & Foundry Company, Louisville, Ky., will soon increase its capital stock to \$60,000 and engage in the building of tank cars, besides rebuilding and general repairing of railway equipment. The officers of the new company are Charles Schimpeler, president; C. H. Schimpeler, vice-president, and Henry Schimpeler, secretary.

George C. Fisk, formerly president of the Wason Manufacturing Company, of Springfield, Mass., died at his home in Springfield on April 6, at the age of 86. Mr. Fisk began work for the Wason Manufacturing Company about 1852 as bookkeeper, and became president in 1870. This company was absorbed in 1907 by the J. G. Brill Company, of Philadelphia.

Elbert H. Gary, chairman of the board of the United States Steel Corporation, announced on March 3 that it had been decided to increase about ten per cent the wage rates and salaries

up to \$2,500, of employees of the subsidiary companies, to take effect on May 1. This makes the fourth advance of ten per cent since the first of 1916, making a total increase of more than 46 per cent compounded.

The Keith Railway Equipment Company, Chicago, announces that it has purchased all of the property, assets, business, contracts and good will of the Keith Car Company. The new company will continue to conduct the business under the same management and in the same manner as in the past. It is stated further that it will broaden its field by handling a line of railway mechanical supplies.

W. A. Means, secretary of the B. F. Goodrich Company, has been elected second vice-president of the company and has been succeeded as secretary by L. D. Brown, cashier of the First-Second National Bank of Akron. Mr. Means has been connected with the B. F. Goodrich Company for almost 20 years. He has been treasurer for seven years, previous to which he was assistant treasurer for 12 years.

Fire originating in the upholstery department of the Pullman Company, Chicago, Ill., caused approximately \$100,000 damage on the night of March 9. The building, which was two stories high, of brick construction, and 250 ft. by 150 ft., was protected by four thick fire walls, two of which were burned entirely through. Besides the destruction of the building itself much valuable material, such as plush draperies, valuable hard woods and oils, was consumed by the flames.

Detailed plans have been completed and are in the course of execution for rebuilding the burned portion of the plant of the Hydraulic Press Manufacturing Company, on its present site in Mount Gilead, Ohio. The plans also include the erection of two additional buildings which will give more adequate manufacturing facilities for the rapidly expanding business. In all, the plans cover the erection of four complete new buildings consisting of a machine shop, a three-story stock room, a new power plant and a structural and forge shop. The machine shop and stock room are replacements on a much larger scale of the portion of the plant recently destroyed by fire. It is planned to have the new buildings in operation by July 1.

The Bradford-Ackermann Corporation, recently formed by A. H. Ackermann and C. C. Bradford, with offices in the 42nd Street building, New York, announces that it has concluded arrangements with Ashton, Laird & Co. for the sole selling rights of "Astra" high temperature gas apparatus and oxygen welding appliances, manufactured from the designs and patents of E. Raven Rosen-Baum, consulting engineer on high temperature gases. In addition to the extensive line of oxy-acetylene welding appliances, there will be marketed a new and standardized line of oxy-illuminating gas apparatus exclusively manufactured by this company. In this process either natural or artificial illuminating gas, direct from the town supply, is substituted as a supporting gas in connection with oxygen.

Robert W. Hunt & Co. has offered the services of its entire bureau of inspection, tests and consultation to the government at actual cost in a letter to the Secretary of War dated April 20. This includes all of the 700 employees in the main office at Chicago and in the branch offices and laboratories in New York City, Pittsburgh, St. Louis, San Francisco, Montreal and London. This offer is made in the belief that this large and highly specialized organization can be of service to the country in a particularly practical manner at less cost to the country than equivalent services can be obtained otherwise. The acceptance of this proposal will relieve government officers from inspection duties for services of greater value in other directions, and will enable the government to utilize this organization intact without the necessity of gathering together other men into a similar organization which it would take

time to develop. In addition to its work for many of the railways and other large private corporations, this company is now and has been performing inspection work for the British, Russian, Italian, Netherland and French governments, not only on munition orders, but also on steel rails and their fastenings and other railway equipment.

The Vapor Car Heating Company, Inc., has taken over all of the heating and ventilating business of the Chicago Car Heating Company and the Standard Heat & Ventilation Company, Inc. The main office and headquarters of the consolidated company will be in the Railway Exchange, Chicago. The following officers have been elected: Egbert H. Gold, president; J. E. Buker and J. Allan Smith, vice-presidents; Samuel Higgins, vice-president and treasurer; Winthrop Gold, assistant treasurer; Edward A. Schreiber, general manager; Arthur P. Harper, secretary and controller, and Otto R. Barnett, general counsel. Branch offices have been established in New York City in charge of Samuel Higgins and George T. Cooke; Boston, Mass., in charge of Frank F. Coggin; Montreal, Can., in charge of F. A. Purdy, and S. P. Harriman; Washington, D. C., in charge of Harry F. Lowman, and Atlanta, Ga., in charge of Lewis B. Rhodes.

Frederick C. Blanchard, who was recently elected vice-president in charge of manufacturing for the Detroit Lubricator Company, with headquarters at Detroit, Mich., was born in Boston, Mass., October 19, 1869. He graduated from the Massachusetts Institute of Technology with a degree in mechanical engineering in 1891. Prior to being elected to the above position he was for four years production manager for the Fort Wayne Electric Works, Fort Wayne, Ind., leaving this concern to become works manager of the Ashcroft Manufacturing Company and the Consolidated Safety Valve Company owned by Manning, Maxwell & Moore, New York City. Later he was made chairman of the manufacturing committee of the latter corporation, then being elected a member of the board of directors. He has now resigned these several connections to take charge of the manufacturing department of the Detroit Lubricator Company.



F. C. Blanchard

E. N. Layfield, secretary of the Western Society of Engineers, has resigned, effective May 1, to become associated with W. F. M. Goss, president of the Railway Car Manufacturers' Association. Mr. Layfield has been secretary of the Western Society of Engineers for about a year, practically all of his previous experience having been in railway engineering work. Beginning in 1892 he was employed in maintenance of way and construction on the Pennsylvania Railroad between Philadelphia and Washington. He entered the services of the Chicago Terminal Transfer Company in 1899, serving as chief engineer of that company from 1905 till 1910, when the road was taken over by the Baltimore & Ohio as the Baltimore & Ohio Chicago Terminal. He remained with the last named company one year longer in the capacity of division engineer, when he resigned to engage in private consulting practice, specializing in grade separation investigations. He accepted the position of assistant secretary of the Western Society of Engineers late in 1915, and was appointed secretary on January 21, 1916. Mr. Lay-

field's headquarters will be with Mr. Goss at 61 Broadway, New York, the headquarters of the association.

Harvey B. Slaybaugh, assistant secretary of the American Arch Company since 1910, has been elected secretary of the company. Mr. Slaybaugh was born in 1872 at Wooster, Ohio. He was educated in the public schools at Kingsville, Ohio, and Oberlin College. In 1893 he entered the service of the Lake Shore & Michigan Southern at Norwalk, Ohio, and worked in the locomotive department. He served in various capacities as timekeeper, stenographer, accountant and storekeeper to January, 1899, at which time he was transferred to the office of the superintendent of motive power. In 1908 he was appointed chief motive power clerk, in charge of both locomotive and car work. In July, 1910, he left railway service to become assistant secretary of the American Arch Company, which position he held until his election as secretary.



H. B. Slaybaugh

Thomas Dunbar, Sr., who was recently elected president of the Acme Supply Company, Chicago, has been connected with the railway supply field since 1885. He entered the service of the Pullman Company as a car builder and was later a template maker. In 1893, he was promoted to general foreman, and in 1902 became superintendent. Two years later he was advanced to manager of the works of this company and in 1910 was appointed manager of the mechanical department. He resigned this latter connection in April, 1916, and spent the interval between his resignation and present election recuperating on his ranch in Arizona. He succeeds H. H. Schroyer, retired.



T. Dunbar, Sr.

At a special stockholders meeting of the Milwaukee Refrigerator Transit & Car Company, held Saturday, April 7, a sale of the entire business of this company to the Marsh Refrigerator Service Company was authorized, effective May 1. The latter company was recently incorporated with a capitalization of \$800,000 for the purpose of taking over the business formerly conducted by the Milwaukee Refrigerator Transit & Car Company. The business will in future be under the active management of H. W. Marsh, who has been identified with the old company for seven years as its vice-president and general manager. The officers of the new company are H. W. Marsh, president; Oliver C. Fuller, vice-president, and J. J. O'Connor, secretary. The new company will continue to operate the refrigerator car lines and will manufacture, sell, repair and lease refrigerator cars as well as rebuild and repair all classes of railroad freight cars at its

Milwaukee car shops. Owing to the increasing demand for refrigerator cars equipped with steel underframes the new company proposes to invest a considerable sum of money in steel underframes, standardizing and modernizing its entire equipment. The general policy and conduct of the business will remain unchanged.

J. W. Kelker, who has been appointed mechanical engineer of the Pilliod Company, was born October 12, 1882, at Denver, Col. He was educated in the public schools of that city,



J. W. Kelker

and entered railroad service August 24, 1898, as a messenger to the superintendent of motive power of the Denver & Rio Grande at Denver. On December 4, 1899, he was made a machinist and drafting apprentice in the locomotive department, serving until February 16, 1903, at which time he left railroad service to enter the employ of the American Locomotive Company, at Dunkirk, N. Y., as locomotive draftsman. On July 7, 1907, he was transferred to the general drawing room at Schenectady as assistant engineer, and it is this position he leaves to take up his new duties with the Pilliod Company.

Frank N. Grigg was recently elected manager of sales for the car department of the Harlan & Hollingsworth Corporation. He succeeds Henderson Weir, deceased, in that capacity, but does not succeed him as secretary, as was incorrectly reported in the April issue of the *Railway Mechanical Engineer*. Mr. Grigg was born at Richmond, Va., August 9, 1876, and was educated in the public schools of that city. He entered the service of the Chesapeake & Ohio at Richmond, Va., in February, 1892, working in the motive power and stores departments. He left that road in January, 1903, to go with the Adams & Westlake Company



F. N. Grigg

of Chicago as sales representative in the eastern territory, with headquarters at Philadelphia. In January, 1913, he became district manager of the Standard Heat & Ventilation Company, with headquarters at Washington, D. C., but in January, 1914, left the service of that company and opened offices at Richmond, Va., representing in the southeastern territory the Acme Supply Company, the Heywood Brothers & Wakefield Company, and the Transportation Utilities Company, which accounts he will continue to handle in connection with his duties as manager of sales for the car department of the Harlan & Hollingsworth Corporation. Mr. Grigg's headquarters will be as heretofore at 1201 Virginia Railway and Power building, Richmond, Va.

Leslie W. Millar, formerly sales manager of Fahn-Mc-

Junkin, Inc., New York City, has been appointed special railroad representative of the Mark Manufacturing Company, Chicago. He was born at Boston, Mass., March 22, 1879, and graduated from the Massachusetts Institute of Technology, with the degree of bachelor of science, in 1902. He was engaged on various engineering works from that time until 1904, when he became connected with the Edison Electric Illuminating Company, Boston, Mass., as assistant erecting engineer. In 1909, he became associated with the Good Products Company, Chicago, as eastern sales agent, and in 1911 returned to the Edison Electric Illuminating Company as efficiency engineer. In 1913 he resigned to become eastern representative of the Barco Brass & Joint Company, Chicago, which position he held until January, 1917, when he became sales manager of Fahn-McJunkin, Inc.



L. W. Millar

James Buchanan Brady, vice-president of the Standard Steel Car Company and one of the railway supply field's great salesmen, died at Atlantic City, April 18. Mr. Brady was born in New York City, August 12, 1855, and was a life-long resident of that city. He was educated in its public schools and began his business life as a messenger boy in the offices of the New York Central Railroad. He soon afterward found employment with the firm of Manning, Maxwell & Moore, and very soon showed a decided salesmanship ability, and it was through that channel that he grew into national prominence. After he was with Manning, Maxwell & Moore a number of years he became identified with the Fox-Pressed Steel Company, subsequently the Pressed Steel Car Company. He became associated with the Standard Steel Car Company upon its organization 15 years ago and was its vice-president from its organization up to the time of his death. Mr. Brady was also president and director of the Independent Pneumatic Tool Company, vice-president and director of Manning, Maxwell & Moore, Inc.; president and director of the Thermoton Company, director of the United Injector Company, vice-president of the Keith Car & Manufacturing Company and of the Osgood Bradley Car Company, director of the Consolidated Safety Valve Company, and he was interested in several other enterprises connected with railroad products.



J. B. Brady

Mr. Brady was known in the railway field as an exceedingly keen business man. He had an extremely wide acquaintance among the higher railway officers and was recognized as an exceptionally successful salesman of railway cars and other railway supplies.

CATALOGUES

TURRET LATHES.—A booklet recently issued by the Gisholt Machine Company contains reprints of five advertisements of Gisholt turret lathes from the American Machinist.

FLEXIBLE GRINDERS.—The Stow Manufacturing Company, Binghamton, N. Y., has issued bulletins 18 and 33 dealing respectively with its center grinder and its adjustable flexible grinders.

COOLING TOWERS.—A looseleaf booklet recently issued by the Cooling Tower Company, Inc., of New York, describes and illustrates some of the forms of cooling apparatus made by that company.

LIST OF STEEL AND OTHER PRODUCTS.—This is the title of a 52-page booklet recently issued by the Midvale Steel Company, the Cambria Steel Company and Worth Brothers Company. The book gives a complete list, alphabetically arranged, of the products made by these companies.

BALL BEARING AND INDUCTION MOTORS form the subject of bulletin 211-A issued by Fairbanks, Morse & Co., Chicago. The bulletin gives a short description of the bearing, the rotor with solid metal winding, and a vertical shaft motor. A table of standard horsepower and speeds is also included.

FORGINGS.—Bulletin 87, recently issued by the Union Switch & Signal Company, deals with the company's forge plant. The company is able to handle expeditiously any type of forging made from open hearth, crucible, nickel, chrome, vanadium, bronze and other alloy steels. The fire on February 10 did not reach the forge plant.

WHEELS.—The American Steel Foundries, Chicago, Ill., has issued a very attractive and artistically illustrated pamphlet on the evolution of the wheel. It is written in the form of a poem, and briefly describes the development of the wheel as the means of transportation, and closes with a description of the Davis steel wheel and its advantages.

SPRAYING EQUIPMENT.—A catalogue recently issued by the Spray Engineering Company, Boston, Mass., gives a condensed summary of the principal Spraco developments. The booklet illustrates and describes the Spraco system for cooling condensing water, Spraco air washing and cooling equipment for electrical machinery, apparatus for paint spraying, sprinkling, etc.

AIR BRAKE EQUIPMENT.—The Westinghouse Air Brake Company has recently issued special publication No. 9021, on "Extra Quality Pipe Fittings for Railroad Air Brake Service." This is a carefully prepared booklet, which emphasizes the better air brake service and saving of money made possible to railroads by the use of reliable pipe fittings in all air brake work on locomotives and cars.

FLANGE OILERS.—The Detroit Lubricator Company, Detroit, Mich., has issued a catalogue treating of the Pendulum type of flange oilers. Part one is devoted to a description of the attachment and the second part treats on proper installation. A second publication called catalogue No. 37 L contains 64 pages and deals at length with the Bulls Eye locomotive lubricator and locomotive specialties.

SINGLE-PHASE MOTORS.—Motors of 1/6 to 7½ hp. are described in bulletin No. 41,514 of the Sprague Electric Works of General Electric Company, New York. The motors are of the BSS type, varying speed, and represent the latest step in the commercial development of small single phase motors. Numerous illustrations are used to show the application of BSS motors to various machines.

STEEL PLATFORMS FOR ELEVATING TRUCKS.—Bulletin

No. 37, recently issued by the McMyler-Interstate Company, Bedford, Ohio, illustrates that company's steel platforms for use with hand operated elevating trucks. These steel platforms have the advantage over wooden platforms of strength, compactness, suitability for stacking, and of course they are less liable to damage by fire than wooden platforms.

OVERHEAD HAND-TRAVELING CRANES.—Catalogue P, issued by the Brown Hoisting Machinery Company, Cleveland, Ohio, describes that company's line of Brownhoist overhead hand-traveling cranes. The booklet in its 36 pages shows the construction of the cranes and trolleys, and contains a large number of illustrations of the cranes, of their essential parts, also of some of the shops in which this equipment has been installed.

STEAM ROAD ELECTRIFICATIONS.—This is the title of a booklet published by the Ohio Brass Company, Mansfield, Ohio. Well chosen photographs and short explanations describe seventeen steam railroad electrifications on which Ohio brass materials have been used. The book is really a short review of all electrification work in this country. The photographs are excellent and the composition of the booklet a work of art.

CRANES.—The Whiting Foundry Equipment Company, Harvey, Ill., has recently issued Catalogue 127, descriptive of the company's line of cranes of all types for every service. The booklet contains material relative to electric traveling cranes, locomotive and coach hoists, gantry traveling cranes, etc. Views are given of the cranes and their details, and one-half of the 48 pages are devoted to views of the Whiting cranes at work.

THOR TOOLS.—The Independent Pneumatic Tool Company, Chicago, has issued catalogue No. 10, containing 94 pages descriptive of its pneumatic and electric tools used for drilling, reaming, tapping, flue rolling, riveting, shipping and other work of a similar character. In addition to illustrations of the tools described, the catalogue contains tables of properties, dimensions and weights and other information of interest in connection with the tools.

REDUCING VIBRATION AND NOISE.—This is the title of a booklet recently issued by the Armstrong Cork & Insulation Company, Pittsburgh, Pa., to show the excellencies of Non-pareil cork machinery insulation. This insulation is used for reducing the noise and vibration of fans, motors, printing presses and machinery generally. The booklet emphasizes the necessity for eliminating this noise and vibration in so far as possible, and show with illustrations how Non-pareil insulation secures the desired results.

TENDER TRUCKS.—A pedestal truck with side frames spring supported is described in Bulletin 113 issued in February by the Economy Devices Corporation. Two types are described, one for passenger and fast freight service, the other for switching and slow freight service. Both have side frames supported by triple helical springs resting on box yokes enclosing standard M. C. B. journal boxes. By the use of this box yoke, hinged to the side frame, the necessity for special journal boxes has been obviated and pedestal wear eliminated. Side frames are of cast steel, U-section throughout.

VACUUM PUMPS.—The Ingersoll-Rand Company has recently issued two new catalogues on dry vacuum pumps, Form No. 3037 covering the straight line type, and Form 3058 the duplex type. Both machines are equipped with "Ingersoll-Rogler" valves, are capable of maintaining a high vacuum and will handle discharge pressures of several pounds. The maximum degree of vacuum possible varies with the different machines to within 6 in. of the barometer. Both steam and power driven pumps in a large range of sizes and capacities are listed. The catalogues are profusely illustrated in colors to show the machines in whole and in section.

Railway Mechanical Engineer

Volume 91

June, 1917

No. 6

CONTENTS

EDITORIALS:	
Rod Job Competition.....	283
Mechanical Department Valuation Organization.....	283
Rules for Loading Lumber.....	283
Conserve Your Fuel Supply.....	284
Buy a Liberty Bond.....	284
Locomotive Feedwater Heating.....	284
Keeping Cars In Service.....	285
Car Shortage or Congestion?.....	285
New Machine Tools Versus Old Tools.....	286
"Do Your Bit".....	287
Greater Shop Output Required.....	287
New Books.....	288
GENERAL:	
Centralized Production of Locomotive Repair Parts.....	289
Selection of Machine Tools.....	292
Power Tests of Machine Tools.....	294
Developments In Railway Shop Tools.....	297
Improve Railroad Efficiency.....	299
Fuel Association Convention.....	301
The Machine Tool Situation.....	306
SHOP PRACTICE:	
Electric Welding on the Rock Island.....	307
Grinding and Milling Work.....	309
Rack for Storing Boiler Sheet Stock.....	314
Increasing Output and Reducing Unit Costs.....	315
Locomotive Rod Job.....	317
Milling Machines In Railroad Shops.....	321
Welding a Cracked Cylinder.....	322
Gages for Determining the Lift of Air Pump Valves.....	322
LOCOMOTIVES:	
Locomotive Feedwater Heating.....	323
Mikado Type Locomotive Tests.....	328
Kindling Fires in Locomotives.....	332
Philadelphia & Reading Mallet Locomotives.....	333
Good Firing.....	334
CAR DEPARTMENT:	
The Lubrication of Freight Cars in Interchange.....	335
Wooden Framed Freight Equipment Cars.....	336
Santa Fe Double Deck Stock Cars.....	337
Importance of Proper Loading of Cars.....	341
Reducing Breaks-in-Two on the Santa Fe.....	341
Air Brake Association Convention.....	342
Eric Dining Cars With Unique Table Arrangement.....	346
NEW DEVICES:	
Plain Grinding Machines.....	347
"Cisco" Relieving Attachment.....	348
Libby High Power Turret Lathe.....	349
Cincinnati Planer.....	350
Morris Standard Engine Lathe.....	351
All-Geared Drill and Tapper.....	351
Ball Bearing Bench and Floor Grinders.....	352
Armstrong Tool Holders.....	352
American Flexible Staybolt.....	353
Vertical Surface Grinding Machine.....	353
Back Geared Crank Shaper.....	354
Valveless Boiler Scaler.....	354
Flue Reclaiming Attachment.....	354
Quick Releasing Face Milling Cutter.....	355
Type "C" Dumore Grinder.....	355
A Handy Pipe Vise.....	356
Flexible Pipe Connection.....	356
Automatic Metal Cutting-Off Machines.....	356
Loco Light Headlight Equipment.....	357
Expansion Joint with Crosshead Guide.....	357
NEWS DEPARTMENT:	
Notes.....	358
Meetings and Conventions.....	360
Personal Mention.....	361
Supply Trade Notes.....	365

Rod Job Competition

The rod job competition, which closed May 1, was participated in by eight contestants. The judges awarded the first prize to Ernest A. Miller and his contribution appears elsewhere in this issue. The second prize was awarded to H. M. Brown, shop superintendent, Chesapeake & Ohio, and the third prize to James Grant of the Great Northern. These two latter papers will be published in future issues in connection with such of those of the other contestants as have been accepted for publication. One contribution was submitted anonymously and for that reason had to be excluded from consideration by the judges. Conditions in different shops will, of course, govern to a large extent the practices followed, but in many cases some shops may be doing certain parts of the work more economically than others; if so we shall be glad to hear from them.

Mechanical Department Valuation Organization

The mechanical departments of some roads have tried to evade active participation in the valuation work. This is poor policy. If a proper valuation is to be made the men most familiar with the material or property being valued should be used. There should be one man in charge of mechanical department valuation and he should be thoroughly familiar with the road, its shops and equipment. For assistants he should have under him men more familiar with the details than he. At best, the

mechanical department valuation is difficult. There is a greater amount of capital represented in the property under the control of the mechanical department than is generally realized, and the cost and value of this property must be carefully determined. Where changes have been made, and there is hardly a case where they have not been made, no one is better able to determine what they have been, how they should be charged, and what they amounted to, than the men who have directly followed this work. It is important therefore that every mechanical department should do its share in the onerous work of valuation.

Rules for Loading Lumber

Shipments of dressed lumber probably necessitate more shifting and transferring of loads than those of any other one commodity. A great deal of trouble is experienced with flat and gondola cars which are loaded strictly in accordance with the rules, the load shifting and either fouling the brake staff or extending over the end of the car. Inspection of loads which have shifted often reveals the fact that boards have not been overlapped properly, resulting in parts of certain tiers being free to move and sliding when starting or stopping, but the same trouble can be found where the loading has been properly done. Wooden frame box cars loaded with lumber often have the whole end torn loose by the shifting of the load and even in cars of the most substantial end construction the end posts are often bent in the same way. It is important for the rail-

roads to find some method of securing dressed lumber which will avoid the trouble experienced under the present methods of loading. It may be that raising the end of the tiers will have the desired effect. If that does not prove feasible an inexpensive form of end support for flat and gondola cars will probably remove the principal difficulty. The danger to train men, the damage to equipment and the delays to loads justify the adoption of whatever measures may be found necessary to do away with the troubles now so often encountered with loads of dressed lumber.

**Conserve
Your Fuel
Supply**

The railroads are having extreme difficulty in contracting for their coal for the coming year. Some of the largest roads have been able to contract for

only 50 per cent of their fuel requirements at a very substantial increase in price. The other 50 per cent must be bought in the market, the increase in price being far in excess of 50 per cent. Estimates from various authoritative sources indicate that the railroads will have to pay over \$100,000,000 more for coal this year than last. This makes necessary the most careful use of fuel from the time it leaves the mines until it is thoroughly consumed. The International Railway Fuel Association, appreciating this condition, adopted at its recent convention a complete set of suggestions which, if followed, will aid materially in the conservation of fuel. These are published on other pages of this issue in connection with the report of the convention. The seriousness of the situation demands that these recommendations be given the most thoughtful consideration. They are familiar to many of our readers and to those who have followed the Fuel Association proceedings carefully. Some of the items have been tried and found uneconomical, but should now be reconsidered as the great increase in the price of fuel gives a very different aspect to the problem and furnishes a new basis on which to work.

The output of our factories and mills has tremendously increased and they must have coal in larger quantities. In addition to this, the United States will be called upon to furnish a large amount of fuel to France and Italy. This again will make deep inroads into our fuel supply. It is, therefore, the patriotic duty of every man handling fuel on the railroads to make every pound do its utmost, releasing as much as possible for the use of others, as well as decreasing the cost of locomotive operation.

**Buy a
Liberty
Bond**

First, they formed the Railroads' War Board; next, they proceeded to form nine engineer regiments for service in France; then, they made large subscrip-

tions to the War Loan, and now, they are going to assist their employees to buy Liberty Bonds. Certainly, the American people have reason to be proud of the way their railroads have joined the vanguard in the present crisis. It is now up to railway officers and employees to help the railroads stay in the first division; and they can help in two ways, one by doing their level best at their daily tasks of keeping the transportation system at its high notch of efficiency and the other by buying a Liberty Bond. Railwaymen will not easily be spared for service in the field. But, if they cannot shoot leaden bullets they can shoot silver bullets; they can buy Liberty Bonds.

Nearly all the railroads have offered their employees opportunity to subscribe on a partial payment plan. It should not be hard to pay for a \$50 or a \$100 bond in 5 or 10 or 12 monthly installments and even if his railroad has not yet acted, an officer or an employee can buy a bond from his bank. Secretary McAdoo says that a \$50 bond can be bought for 2 per cent or \$1 on application, 18 per cent (\$9) on June 28, 20 per cent (\$10) on July 30, 30 per cent (\$15) on

August 15 and 30 per cent on August 30. Certainly railwaymen lack no incentive to subscribe. And the bonds are good investments, 3½ per cent, tax free and convertible into higher interest paying bonds if such are later issued. But what is most important, railwaymen who subscribe help their country in a very practical patriotic way. The United States offers these bonds in low denominations and on easy payments because it is your subscription it wants. It wants subscribers rather than money. It wants to show that the people are behind this fight for the liberties of mankind. Subscribe and show your fellowmen and the foe across the sea where you stand.

**Locomotive
Feedwater
Heating**

At the recent convention of the International Railway Fuel Association an exhaustive report was presented on locomotive feedwater heating, an abstract of which appears elsewhere in this issue. Both the exhaust steam and waste gas methods of preheating feedwater were discussed. For maximum economy, the feedwater must be brought from the temperature of the water in the tank to the temperature of the water in the boiler by using the smallest possible amount of steam direct from the boiler. A large amount of live steam is required where the injector is used, and the water is heated to about 160 deg. by the steam with no economy in heat. In this case, therefore, the saving to be made by preheating with the wasted heat must lie between the heat contained in the water at 160 deg. and the heat in the water when it is raised to the highest temperature the feedwater heater is susceptible of furnishing. Where a steam-driven pump is used, the wasted heat can start its preheating at the temperature of the water in the tank. This will be found to be the more economical thing to do, as locomotive feedwater pumps are provided that will pump five and six times as much water per pound of steam as the injector.

The maximum amount of preheat that it is possible to add to the feedwater by the exhaust steam method is limited to the temperature of the exhaust steam, which is about 140 deg. less than that of the temperature of the saturated steam in the boiler. On the other hand, the temperature of the gases passing out through the stack is from 600 to 700 deg., or over 200 deg. higher than the temperature of the steam in the boiler. However, there is about three times as much heat available in the exhaust steam as in the waste gases and further, the heat is abstracted from the exhaust steam far easier than it is from the waste gases and a much smaller amount of heating surface is required to give the same amount of preheat. At the present time both methods are more or less in the experimental stage. The exhaust steam method is being rapidly developed and developments are planned for the waste gas method. Extensive tests are being made on the exhaust steam type of feedwater heater, and from the results thus far obtained it has been shown that a net saving in fuel economy of over 10 per cent may be expected. As the smokebox heater is developed and the two methods are used in conjunction with each other, greater economy in fuel will be obtained. Coupled with this economy, the maintenance problems of the two types of heater must be carefully considered. This, of course, can only be determined accurately after the heaters have been tried out in actual service on several locomotives in regular road work.

Feedwater heating in Europe is used to a far greater extent than on this side of the water. Foreign roads have evidently found it successful, or it would not have been developed as far as it has. It remains for us on this side to adapt the problems of feedwater heating to our conditions. A certain amount of experimenting is necessary and the railroads should not hesitate to co-operate to the fullest ex-

tent with the committee of the Fuel Association in developing this new refinement in locomotive construction, which at the present time offers such attractive results.

**Keeping
Cars in
Service**

The Railway War Board in a bulletin issued on May 9, the text of which is published elsewhere in this issue, has called attention to a number of ways

of increasing car efficiency, which if carried out will have the effect of increasing the available number of cars over 700,000, or slightly more than 30 per cent of the total number of freight cars now in existence. One of these suggestions is that a reduction of between two and three per cent be made in the number of cars out of service for repairs, thereby increasing the cars available for service by about 64,000.

Unlike locomotives, which are shopped on a mileage basis, the percentage of cars out of service for repairs is a reflection of previous maintenance policies and of the character of the construction rather than of the service being rendered. In devising ways and means of reducing the number of cars out of service for repairs, less attention, therefore, need be given to increasing facilities and labor than to locating weaknesses in design and correcting them when heavy repairs are made. It hardly need be stated that for months to come it is absolutely essential that the maximum of results be obtained from every hour of labor expended in maintaining equipment. To maintain some of the rolling stock now in service, as it originally was built, is little short of a sheer waste of effort. Such equipment leaves the repair track only to appear on another one a few days later. In order not only to increase the number of cars available for service, but to avoid serious delays to traffic, it is highly important that such equipment be placed in condition to *stay off the repair track*.

Whenever special effort is directed to reducing the number of bad order cars, there is always a temptation on the part of local officers to make a showing by overlooking certain bad order conditions in the hope that the cars may get off the division or the road before failure occurs. While the immediate effect of such a policy is an apparent improvement in the number of cars out of service, eventually the results are sure to be disastrous. In the present congested conditions of many of our roads the delays, if only a few minutes each, while setting out bad order cars which should never have been placed in the trains, causes a loss of transportation efficiency far greater than can be compensated for by any increase in the available number of cars effected by such a policy. It is a question whether the car shortage which has been apparent for some months past is not less an actual shortage than a congestion which has reduced the available supply. It must be clear then, that no policy of slighting essential repairs should be tolerated in the present emergency.

The efforts of the car department must be concentrated on underframes, draft gears, trucks and brake rigging. That repairs to these parts be thoroughly done and that weak designs be strengthened to withstand the severe shocks of present day service is essential. Other parts may be patched up or even allowed to deteriorate to a certain extent without serious consequences. There are a large number of wooden cars in service which are too weak to withstand service conditions on many of the roads to which they are offered in interchange. As fast as materials can be obtained, these cars should be fitted with some form of continuous steel center sill construction or at least with steel draft arms. Such changes undoubtedly may be unnecessary to meet the conditions on the home road. It must be remembered, however, that the railroads are now operating as a single system and that it is essential as never before that cars all be of suffi-

cient strength to withstand the severest conditions anywhere to be met with. Arch bar trucks of weak construction, especially those with flat compression members, should be replaced as fast as material for new ones of improved design can be secured.

The cost of making such changes at the present time no doubt will be high, but in the face of a constantly decreasing supply of labor the only way it will be possible to keep the number of bad order cars within reasonable limits, is to send the cars out from the shops in such condition that they may be expected to stay out for months and not days. The war is not yet over; it may last for a year, two years, even longer. Any slighting of the maintenance of essential parts of the car for the immediate advantage which may be gained thereby will be disastrous later when the conditions of the labor market are even worse than at present and when the demands of the nation for transportation are even greater and more insistent than at the present time.

**Car
Shortage or
Congestion?**

Railway mechanical department officers, the country over, are trying to figure out whether it is a car shortage or a car congestion that is bothering them. We will not presume to answer the question, but will outline certain facts that may throw light on the situation.

Since the first of January the railways of the United States and Canada have ordered no less than 1,941 locomotives, as compared with only 1,691 in the first five months of 1916. The freight car orders on the other hand have totaled only 33,840, whereas at this time last year they had reached 49,851. It is worth while at this point to add also that the big Russian orders, 500 locomotives and 10,000 cars, reported this last week have brought the totals of foreign equipment ordered to no less than 1,094 locomotives and 24,550 freight cars as against only 634 locomotives and 18,325 cars in the first five months of 1916. The big orders for locomotives, both foreign and domestic, are naturally attracting a great deal of attention, and observers are seeking to find the reason for the continued large buying of power, realizing that it is in spite of extraordinary high prices and deliveries now extending well beyond April or May of next year.

Take the matter of locomotive prices. R. H. Aishton, president of the Chicago & North Western told the Interstate Commerce Commission in the rate advance hearings that during the past 10 years his road had spent on an average slightly over \$6,000,000 a year for new equipment, receiving on that basis an average of 4,000 freight cars, 94 passenger cars, and 94 locomotives. In 1917, for \$6,444,000 it received only 2,000 coal cars and 50 locomotives. W. B. Biddle, president of the Frisco similarly said that his road bought locomotives in February, 1916, for \$36,750 each; that later in the year it had to pay \$51,000 for the same type of locomotive and that in February this year it inquired for locomotives and was told that the lowest price was \$69,750. Howard Elliott declared that locomotives that cost \$50,350 in January 1917 cost \$57,320 in March, 1917, an increase of 13.8 per cent in less than three months. He also presented the following comparison of prices:

Date.	Type.	Weight.	Cost per lb.
November, 1915	Mikado	400,000 lb.	6.65 cents
February, 1916	Pacific	329,000 lb.	8.53 cents
March, 1917	Santa Fe	441,000 lb.	13. cents

He further added that a 50-ton steel hopper car costing \$1,215 in January, 1916, would cost about \$2,800 today.

The point is that despite the high prices for locomotives, the domestic orders reported from January 1 to June 1, 1917, were larger than those in a similar period for at least the last four years. This surely indicates that the railways need locomotives and need them badly.

The railways also need cars, but for some reason the or-

ders for cars are not so great as conditions might seem to demand. The railways, of course, are appalled at the high prices they have to pay for new equipment. There is some reason to believe that the builders, owing to the uncertainties of the present situation, are not eager to tie themselves up with long term contracts. Besides, there is no doubt that many railway men believe that the present difficulty is a matter of congestion rather than of car shortage and that they hope for improvement through the work of publicity to shippers and through the work of the Car Service Committee. Nor must we neglect the argument brought up not so many months since that it is not fair to ask the railways to buy cars that would remain idle during the long periods of car surplus. President Rea, of the Pennsylvania, added a further thought when he stated before the Interstate Commerce Commission that, "Some say that more cars would only add to the congestion," and that, "if the Pennsylvania were instantly given a lot of cars, they would be immediately scattered to the four winds." He added, however, "I think if we had more open top cars, they could be put to good use. I think that if we could get deliveries and the prices were reasonable, we should get coal cars, possibly 5,000, but I wouldn't pay the present prices for them."

The question, in short, is put up entirely to the mechanical department. The railways must use their locomotives, new and old, to the best possible advantage. They will have difficulty in getting new ones because of the high prices and slow deliveries and the competition for space on the part of the foreign orders. The Russian Government alone now has considerable over 700 locomotives on order in this country, and a committee of which S. M. Vaucrain is chairman is investigating to see, among other things, if perhaps we cannot furnish even more locomotives to our allies overseas.

The mechanical department officers must realize further, as we emphasized last month, that this shortage of power is going to continue and perhaps become more acute from month to month, although it is possible that the contemplated reductions in passenger service may release sufficient power to counteract in some measure the increased demands for locomotives resulting from an increased traffic to the seaboard and to the 32 concentration camps which will soon be under way.

It may easily be seen that conditions are becoming such that any railway that wishes to retire locomotives from service should consider the step carefully, and it is axiomatic that now as never before, should mechanical department officers be careful that all engines in service are kept in the best condition possible under the circumstances.

New Machine Tools Versus Old Tools

The master mechanic was showing a visitor through the shop and they paused at the wheel lathe which was turning off heavy, blue chips. "Before we got that machine," said the master mechanic, "we kept five lathes busy turning wheels and we were nearly always working some of them overtime. Now we have scrapped all but one of the old machines and we don't have any trouble in getting our output. We're up against the same sort of a proposition with our driving boxes now, and I'm having just as hard a time getting the machines I want as I had when I asked for this wheel lathe. I don't see why we can't get enough money appropriated to buy the tools we need."

The master mechanic's complaint is one that is heard time and again. On most railroads it is hard to get money appropriated for machine tools, much harder than it is to get new locomotives or cars, for instance. It is not uncommon to find roads with the most modern type of motive power having poor shop equipment. This is a natural condition, for the railroads have found it difficult to raise money and the tendency is to spend it where it will have

most direct and apparent effect on the cost of operation. The saving effected by the elimination of old tools is as a rule not especially apparent but a policy of systematic replacement is a vital factor in keeping up the efficiency of a shop. Modern machine tools will pay a high return on the investment and obsolete tools should be retired as rapidly as possible.

At the present time it is a difficult matter to secure skilled mechanics and the wages paid by railroads for that class of labor are higher than ever before. The demand for men will be further increased, and the supply depleted by the war. For these reasons it is important that the railroads secure tools that will give the maximum production per man. This applies not only to large points where highly specialized machines are required, but also to small points where machines which can be used on a wide range of work, but equipped with time and labor saving devices, should be installed. Old machines are too often retained in service where a modern tool would save enough in wages to more than pay its cost. Old, low-power machines are hard to handle, besides being inaccurate, and there is no excuse for retaining them in service except where the machine is used only for emergency work. Highly specialized machines should be installed wherever possible, particularly if unskilled labor can be employed to operate them.

An instance which shows the saving of men and money that can often be effected by discarding old tools occurred in a locomotive shop where a great deal of heavy boiler work is done. Three lathes had been fitted with special attachments for finishing crown stays but they gave considerable trouble. If the machines were speeded up to secure greater production the stays bore chatter marks and could not be made tight. A special machine was secured for this work and not only did its production exceed that of the three lathes previously used, but it was readily operated by an apprentice and the quality of the work was all that could be desired.

Sometimes a single inefficient machine holds down the production of the whole shop. Where such conditions exist it is easy to locate the trouble. More often such difficulty is due to having a number of machines which are inadequate to meet the demands made upon them. A shop scheduling system is of great value under such circumstances, as it shows up the weak points of the shop and makes it easy to pick out the machines that are "slackers."

It is unfortunate that the shop accounting methods ordinarily used do not show up more clearly the effect of substituting new tools for old ones. Inefficient tools increase the overhead or surcharge on shop work by reason of their low production. The only way to keep a shop efficient and the overhead expense down is to replace the shop tools systematically.

Many of the tools built before the introduction of high speed steel are uneconomical because of the limited production of which they are capable. Modern tools installed in their places would reduce the cost of the work enough to pay a high rate of return on their cost. It seems to be hard for many men to scrap machinery before it is entirely worn out, but it is often the economical thing to do. The introduction of high speed steel has rendered many machine tools built 15 or even 10 years ago obsolete. It is probable that the heavy, high powered tools now built will not have to be retired until they are worn out; in other words, depreciation of tools built at the present time will be less than that of tools built prior to the advent of high speed steel.

The railroads are now in such urgent need of additional terminal facilities, extra tracks and more rolling stock that there is a tendency to keep down the capital expenditure for new tools. The best basis for tool replacement is a regular depreciation reserve set aside every year and devoted solely

to the replacement of tools. Such a policy will do a great deal toward keeping shop methods up to date and reducing the expense of equipment maintenance.

**"Do
Your
Bit"**

The railways of this country have a tremendous task to perform. For many months they have operated under heavy pressure and abnormal

conditions. Now at a time when ordinarily they would have a breathing space to put their equipment and facilities into better condition, they are confronted with the necessity of moving still greater quantities of supplies and material and of shortly being required to handle large forces of troops and military equipment for the government. It is impossible to add to any very great extent, in the immediate future, to the present equipment or facilities, because of the inability of the manufacturers to furnish the equipment. On the other hand, this is no time for lament or faultfinding at the lack of preparedness or on the foolishness of the misguided regulators and politicians with their restrictive rather than constructive programs, which are largely responsible for the financial difficulties which have confronted the railroads in the last few years.

The emergency is upon us and ways and means must be found to overcome the lack of facilities and equipment and to make up for the men that are being called to the colors. How can it be done? A circular which was issued by the Railroad War Board is published in this issue, or at least such parts of it as are likely to prove of special interest to the mechanical department. It deals with some of the ways in which it may be possible to secure better results. Studying it in a broad way, and reading between the lines, one cannot but grasp the underlying thought upon which it is based, and that is that such improvement as may be made is almost entirely dependent upon each individual in the entire railway organization heartily putting his shoulder to the task and increasing his individual productive capacity to the uttermost. This does not mean forcing one's self to the point of exhaustion; rather does it mean using every means to cut out waste and lost motion, of playing the game skillfully and intelligently in order to get better results. Sometimes we get into a rut and almost literally go ahead with blinders on. Standing back and sizing up the job in a big and analytical way may show us the fallacy of making certain routine moves that we have always considered necessary, may help us to do the job in three-quarters of the time with the expenditure of no greater energy and with just as good results. Here is where every one of us may do our bit, whether it be the laborer in the shop, engine house or repair track, or the head of the department.

The railroads as a whole have awakened to the seriousness of the situation and have given up their individual rights—possibly at great loss to themselves as individual roads—and are operating as a single unit under the direction of the Railroad War Board at Washington. The five men on this board—Fairfax Harrison, Howard Elliott, Hale Holden, Julius Kruttschnitt and Samuel Rea—are giving practically all of their time to this problem, as is also Daniel Willard, chairman of the Advisory Commission of the Council of National Defense. The Railroad War Board is assisted by several committees, including in their membership a great number of railway executives and other experts. Many concrete things have already been accomplished which promise important results and the work has hardly been more than well started. The full success of the project will depend upon the thoroughness into which the individual roads enter into the spirit of the plan. Even though they may have subscribed to it and the boards of directors may have passed favorably upon it, the results will not be what they should if there exists a spirit of faultfinding or jealousy between the various roads. Now, if ever, is the time to put

away petty jealousies and play the game for all it is worth—and the public will surely appreciate it in the end, indifferent as it may sometimes seem.

This truth holds good down through the organization of each road, and even into the ranks. Department jealousies, individual and departmental petty criticisms and faultfinding are brakes on the wheels of progress and efficiency. What is needed is plenty of the oil of human kindness, patience and good will to lubricate the organizations throughout. It is a wonderful opportunity the railroads have of making good and helping to win a great fight in the interests of democracy and righteousness. We will have to do our best with the facilities and equipment at hand and it is up to each individual employee to see that the very most is made of these tools. If the same enthusiastic spirit which has been characteristic of the safety first and the loss and damage campaigns on many roads can be put into the bigger game, there is no question as to the final outcome—and it will be done.

**Greater
Shop Output
Required**

What can be done quickly to bring up the output and efficiency of the average railroad repair shop? What is the weak spot in your shop? What class of work,

or what department, is inclined to lag behind and restrict the output? These are pertinent questions at this time, when the welfare of the nation and of our allies abroad may depend on keeping our locomotives and cars in prime condition and getting the greatest possible service out of them. As important as is increased output, it must not interfere with quality of workmanship; never was there a time when it was more necessary to guard against breakdowns on the road. Some railroads are far ahead of others in the maintenance of their cars and locomotives and some shops are much better off than others in the way of improved shop practices and facilities. Helpful suggestions, based on the experiences of different shops, will be found throughout this issue, one article being devoted entirely to a consideration of recent improvements in machine tools for railway shop work. It is proposed in these comments, however, to discuss certain important general practices which may be made to give splendid returns in the way of increased output if they are not already in effect.

One of the best and quickest ways of toning up a shop organization and locating and strengthening the weak spots is to install a shop scheduling system. Such systems have been described many times in these columns; indeed, we have advocated their installation for the past 12 or 15 years and yet many shops are struggling along with the roughest and most unscientific sort of schedule and seem to have utterly failed to appreciate the remarkable results that may be obtained with a comparatively small expenditure of time and energy in installing a real shop scheduling system. Briefly, the various classes of work on each part of a locomotive are scheduled to be finished at certain predetermined times so that the work as a whole may progress steadily and without interruption in order that the locomotive will be ready for service without fail on a given date. Not only does this reduce the length of time necessary to put a locomotive through the repair shop, but the general foreman or shop superintendent is relieved of a great amount of detail and can give his time to the larger and more important problems which concern successful shop operation. A description of a typical shop scheduling system was given in a paper by Henry Gardner at the 1913 meeting of the International Railway General Foremen's Association and will be found in the *Railway Age Gazette, Mechanical Edition* of August, 1913, page 423. A shop scheduling system in use on the St. Louis & San Francisco was described in the *Railway Age Gazette, Mechanical Edition* of November, 1914, page 588.

The problem of the reclamation of waste or scrap material

has for the time being taken on a new aspect. A few years ago when materials were plenty, warnings were given that reclamation work was being carried entirely too far in some cases and emphasis was placed on better accounting methods to take into consideration the overhead or surcharge costs, as well as the direct costs, and also the necessity of following the reclaimed material into service to see that the parts gave a sufficiently satisfactory service to warrant the work that was put on them. These things are as important as ever, but the cost of material has advanced to such a point that a considerable extension in the classes and condition of materials to be reclaimed is justified. The increase in the cost of labor must not be overlooked, and this may make advisable the addition of certain facilities which under former conditions would not have been warranted. In not a few cases material is so scarce and difficult to get that if it cannot be reclaimed it is not available, and here again it may be advisable to make very considerable expenditures for facilities which under other circumstances would not be justified. The important thing is to keep the cars and locomotives in effective service as great a part of the time as possible.

Because the pages of this journal have been a clearing house for improved shop practices, shop kinks, etc., many of our readers have been able to utilize the experience of others and greatly improve the efficiency or output on certain machines or in certain departments. Attendance at the meetings of the various mechanical department associations has also been a great help and inspiration to many shop foremen and officers. To those who have not made a practice of studying the technical journals and association proceedings the suggestion is made that a study of back numbers and volumes will be very well worth while and will undoubtedly reveal many things that will be helpful in getting almost immediate results.

In recent years there has been a strong and steady tendency toward improving sanitary conditions and providing cleaner premises and more pleasant surroundings. This was done in the realization that the workmen would give better service under such conditions; it was also inspired in some degree by the safety first campaigns. This is all the more important now that there is so great competition for labor. As labor has become more scarce, there has been a tendency in some shops to become more or less careless in this respect. This is unfortunate and some means should be taken to overcome the situation; it is quite possible that women may be used to advantage for the lighter work in connection with cleaning up the shops.

It has become the practice in the larger shops for the shop superintendent to have on his staff one or more men with various titles, ranging from shop demonstrator to efficiency engineer, whose sole duty it was to devise ways and means of improving the output. Shop demonstrators have also given a splendid account of themselves in giving apprentices practical instruction. Where men of the proper training and personality can be obtained for this work there is no question but what it is a paying proposition, and shops which have not yet tried it or which have room for more experts than they now have, will do well to make the best possible use of this means of getting better results. As much as a year or two ago complaints began to come in on the falling off of shop efficiency because of the difficulty in getting and holding skilled mechanics due to the competition of munition and other industries. It is all the more necessary, therefore, to provide such demonstrators for breaking in the inexperienced help.

A wise general foreman will see that his subordinates meet with him regularly in a group in order to talk matters over. Sometimes this can be done more or less informally by having the foremen gather at one place when eating their lunch. Usually, however, a certain time is set apart each week for such meetings. The results may quickly be noticed in the

better co-operation between the various parts of the organization. Try it and you will be surprised at the results.

NEW BOOKS

Turret Lathe Guide. 250 pages, illustrated, 6¼ in. by 9¼ in. Bound in cloth. Published by the Gisholt Machine Company, Madison, Wis. Price \$1.

This book has been compiled for the use of operators and those who are familiar with the Gisholt turret lathe work. It was written with the intention of suggesting the most beneficial way in which to operate and take care of these machines. The use to which these turret lathes may be put, their construction and operation, are thoroughly described in the first part of the book. Under "Tooling" is given an outline of the tool equipment that is used with these lathes and the purposes to which they may be put. The methods of fitting up and handling different jobs are described and quite thoroughly illustrated. The various types of chucks to be used are described in detail. Various other parts of the machine are taken up and discussed in a similar manner. The method of grinding and forming tools is given in quite some detail. Suggested methods for cutting threads and for machining heavy pieces of metal are also given.

Steel and Its Heat Treatment. By Benson K. Bullens, consulting metallurgist. 441 pages, illustrated, 6 in. by 9¼ in. Bound in cloth. Published by John Wiley & Sons, Inc., New York City. Price \$3.75.

Doctor Bullens in the first paragraph of the preface to this book says: "Modern heat treatment should be considered as an art or trade, since it certainly requires knowledge, skill and judgment for its proper performance. These, in turn, necessitate at least some knowledge of heat, of steel, and of the effect of heat upon steel. And all three factors are linked together by the 'human element.'" The human element does play a very large part in the proper heat treatment of steel, but unless supplemented by some knowledge of the change made in the structure of the steel by the heat, the man who relies wholly upon his judgment based on past experience will not produce the results nor meet new conditions as well as he who links his experience with the information obtained from scientific study, or theory, if you like, of the effects of heat on steel.

The author has given in an interesting and understandable way the fundamentals of the structure of steel, how this structure is changed by the addition of heat, what the accurate control of the heat means in obtaining the proper results and what effect the various alloys have on the steel and the method in which they should be handled. His discussion is not limited to the scientific phase of the problem entirely. Methods for obtaining the different steel characteristics are thoroughly described. The book is well illustrated and contains information that men who are interested in heat treated metals should know.

Combustion in the Fuel Bed of Hand-Fired Furnaces. By Henry Kreisinger and others. 76 pages, 6 in. by 9 in., illustrated. Bound in paper. A technical paper, No. 137, issued by the Bureau of Mines of the Department of the Interior.

The object of the investigation of which this book is a record was to determine the conditions governing the processes of combustion in the fuel bed of a hand-fired furnace, to furnish data for the correct design of coal-burning grates and furnaces and their efficient operation. The results also cast light on the problem of clinker trouble as related to fusibility of ash and indicate the possibility of a higher rate of gasification of coal in gas producers.

The report contains general information on the combustion of coal in furnaces and describes the results of numerous tests made in an experimental hand-fired furnace which was designed for an accurate study of the processes of combustion in the fuel bed.

CENTRALIZED PRODUCTION OF LOCOMOTIVE REPAIR PARTS

Large Economies May be Effectuated

By George Armstrong

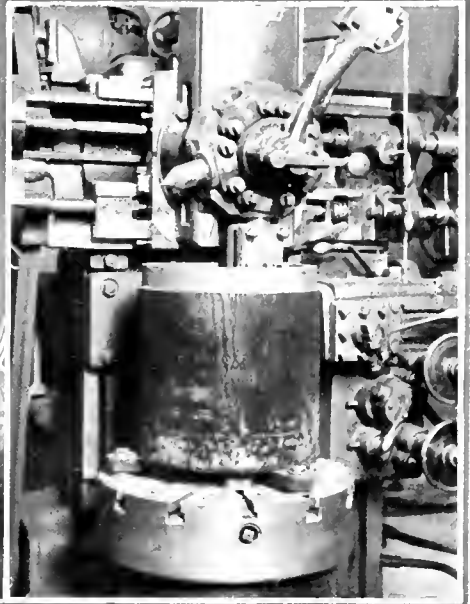
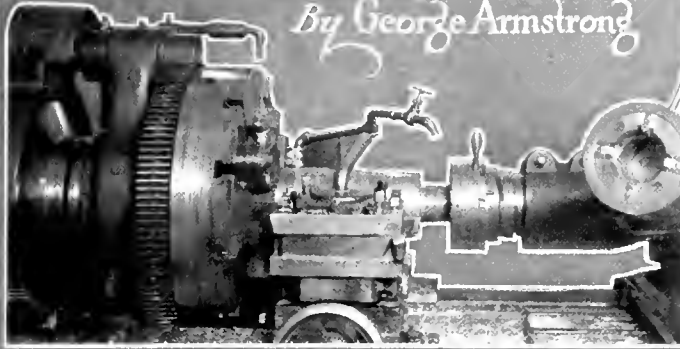

WITHIN recent years quantity production of locomotive and car repair parts at a central point for distribution over the system, has received more and more consideration as an effective means of combating increasing maintenance costs. Several large railroad systems have installed manufacturing departments in conjunction with the larger repair shops, in which are made many parts susceptible to partial or complete standardized finishing. This system manufacturing, or centralized production, as it may better be called, has been and should be much more effective in reducing the cost of many articles, especially those which are required in considerable quantities.

The success of the modern manufacturing industry depends largely upon organization, specialized division of labor, and adequate facilities. While the problem of centralized production cannot be applied to car and locomotive repairs on the same scale as in a manufacturing plant its successful application depends upon the same factors.

The aim of centralized production should be not only economy, but control so that:

- The *right thing* is done at
- The *right time* in
- The *right manner* so as to effect
- The *right result*.

The right result to be secured should be:

- (1) Reduction in the cost of the articles produced.
- (2) Prompt distribution of output.
- (3) Effective distribution of output by eliminating waste due to the use of improper materials or excessive disbursements.

The essentials for successful centralized production are:

- (1) A well defined policy on the part of the management as to scope of the work relative to other parts of the organization and operation.

- (2) An adequate organization.
- (3) Proper equipment.
- (4) Effective records.
- (5) Systematic "follow up."

Without a well defined policy as to the scope, etc., of the centralized production department, a decided handicap is ever present, militating greatly against the success of the effort and prohibiting the attainment of the best results. From

the very inception it must receive the constructive co-operation of the management. A thorough realization of the object to be attained should dictate the necessity for divorcement from any repair shop activities and the development of centralized production as an entirely separate and distinct feature under the immediate direction of the stores department and the superintendent of motive power.

An organization is the machine by which the forces of industry are directed. To be effective, it must embody control. To secure control it must be centralized. Not only centralized, but definite. The objective, dependable output at a substantially reduced cost, demands that the head of the centralized production department be wholly unhampered by needless links in his chain of responsibility, source of supplies, or distribution of product.

Manufacturing is inherently different from repair work, and consequently demands an organization fitted to it, and not merely a modified locomotive repair organization, as an integral part of some repair shop. Successful manufacturing is the result of proper utilization of economic principles, division of labor, quantity production, and systematized cost accounting. Railroad repair work, as the name denotes, is a repair proposition and while it embraces a plane between manufacturing and job repair work, it is only to a limited extent capable of utilizing labor division, and except for those articles adapted to centralized production is wholly devoid of opportunities for quantity production.

If this is true, it follows that the best service will be secured in centralized production with an organization competent to develop and direct a corps of workmen having a definitely divided field of labor due to quantity production. This in conjunction with a cost system adapted to the needs will provide ready and accurate knowledge as to the advisability of continuing to manufacture any article or of purchasing it. The organization chart shows the ultimate development of the centralized production department. Little comment is required as to the duties of the various staff members, except the inspector and shop demonstrator.

The output should be rigidly inspected before being transferred to the storehouse, and in many instances during the process of manufacture so as to detect defects when first disclosed and avoid the expenditure of unnecessary labor. Am-

ple facilities as to limit gages, hydraulic test pump for steam fittings, etc., should be provided. Definite procedures should be established for inspection, recorded in a card file and revised as found necessary, so that defects located in service, etc., may be checked before the material is shipped.

The shop demonstrator should be responsible solely for the machine output. He should instruct new men, follow up work on any new articles, develop the best set-ups and machinery procedures, and time operations for piece work prices or premium time.

Maximum economy will not result if a follow-up inspection is not provided to investigate the service given by the various materials and the quantity consumed. The records should be such that accurate knowledge will be available as to the consumption at the various points, and at any indication of excessive consumption the superintendent of central-

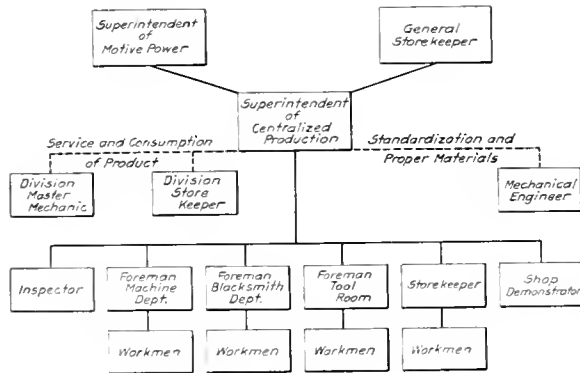

Organization Chart for Centralized Production Department

ized production, or one of his staff, should investigate and in conjunction with the division master mechanic endeavor to locate the cause; i. e., improper material, poor workmanship, improper maintenance, faulty design, etc. Many of the large railroad supply companies, dependent upon their sales for existence, follow up the service of their products so that the railroads will receive the best service at the lowest maintenance cost. Is it not equally as important that a

sweeping changes are required, as in the equipping of locomotives with clear vision windows to comply with the Federal inspection act, and the making of grab irons, handholds, etc., for compliance with the Safety Appliance Act, the organization, facilities and experience of a centralized production department may be of inestimable value.

Little need be said about the actual equipment and scope

PATT NO	Am	1 st CARDS	1 1/2" B. & D.	CARD 4711			
				Chuck blocks C-13			
				1. B-31			
				2. B-24			
				3. H-23 3/4 Shank Centering Drill			
				4. H-105 1/16 Twist Drill			
				5. H-50, H-16 1/2 Std Tap (first)			
				6. Die Head #2023-G 2 3/8 10thd.			
				7. 1/2 x 11 Barling Tool			
				8. 1/2 x 1" Flat nose turning tool			
ORDER	REF	OPERATION	TOOL	GAGE	SPEED	FEED	CUT
1.	A	Chuck- Rough turn body	1				
2.	B	Face back of flange and nick for thread clearance	7				
3.	A	Finish turn body to 2 3/8	3				
4.	C	Chamfer edge of body	2				
5.	D	Center for drill	3				
6.	D	Drill	4				
7.	D	Tap	5				
8.	A	Thread and remove	6				

Instruction Card Showing Tools to Be Used for a Particular Job

of the centralized production department as this has been covered fully in various articles appearing in the past.* However, care should be exercised to equip the plant with the best machine tools adapted for the work, and which the quantity of work to be done will justify.† While, of course, the installation could be made in buildings formerly used for shop purposes, the best method would be to erect suitable buildings, so planned as to give unidirectional flow of material, ample room for expansion, with raw material at one end, finished products at the opposite, and a floor suited for the operation of elevating trucks and loading platforms at the car floor level. Heavy material should be so grouped that it may be carried from the stock yard to the machine tools by means of a traveling crane.

The scope of centralized production embraces a large

Disbursements										Disbursements												
Ordered			Filled				Totals			Ordered			Filled				Totals					
Date	Reqn	Qty	Date	Qty	Inv.No.	Price	Amount	Month	Qty	Amount	Date	Reqn	Qty	Date	Qty	Inv.No.	Price	Amount	Month	Qty	Amount	
1916	C11144		1917																			
11-12	K100-5	75	2-20	75	49164	.123	9.23															
11-20	BK12-1	100	2-20	100	49165	.123	12.30															
12-5	J120-24	6	2-20	6	49166	.123	74															
12-8	R5120-9	200	2-20	100	49167	.123	12.30															
12-8	K12-12	250	2-20	125	49168	.123	15.38															
12-20	X1-22	75	2-20	75	49169	.123	9.23															
1-5	C11144	300	2-20	100	49170	.123	12.30	Feb	581	71.48												

Form for Checking Distribution and Consumption of Products

railroad should carefully follow up the service of material which it manufactures for its own use?

Another equally important factor is the assistance which the superintendent of centralized production may render in standardizing parts of equipment. Responsible as he is for the manufacturing facilities, he should be well equipped to advise and study the possibilities of standardization, and the essentials for producing the standardized parts. When

variety of articles which can be produced at a substantial reduction, in quantities, from the cost at which they can be produced locally with inferior facilities. By no means should the field of highly specialized industry be invaded without a thorough cost analysis, taking into consideration besides

* Railway Age Gazette, Mechanical Edition, 1914, page 593; and Betterment Briefs by H. W. Jacobs.

† Railway Mechanical Engineer, February, 1916, page 89.

those factors actually absorbed in the plant accounts (power, plant supervision, tools, non-productive labor, etc.) the larger factors taken up in other accounts (department supervision, depreciation, interest on investment, etc.,) and which are real costs and included in competitive industries' costs of production. Even though a profit is still shown, an analysis should be made of the intangible factors among which may be mentioned traffic relations with shippers, interdependence of industry and transportation, etc., before it is decided to manufacture.

Water glass fittings, gage cocks, oil cup parts, cylinder

ing tools, so that they are readily available. Tools should be marked with a key letter and serial number and storage space provided so as to definitely locate all tools. An instruction card, such as is shown in one of the illustrations, should be provided for information in getting tools together for a job; it will also serve as a guide to the operator if he is unfamiliar with the job.

The routine of handling and filling orders should be simple, yet consistent with an accurate, readily accessible record for checking distribution and consumption of the product. One of the forms illustrated is well adapted for such a rec-

Pattern or Shape No.		Am 15063														Maximum		
																Minimum		
Raw Material												Finished Material						
Ordered		Received						Delivered to Shop		Delivered in Stores			Disbursed					
Reqn.	Qty	Date	Qty	Wgt	Consignor	Reqn.	Order or Inv. No.	Price	Amount	Qty	Amount	Date	Qty	Price	Amount	Date	Qty	Amount
10-46	300	11-15	200	260	Am. Malt Co. Co	10-46	-	.065	1320	700	4530	2-15	700	.123	8610	3-17	581	7148
12-45	2000	12-18	100	132	-	10-46	-	.065	660			3-17	119	.123	1462			
		1-2	400	518	-	12-45	-	.065	2590									

Master Record (Monthly) of Material for Centralized Production Plant

packing rings, valve packing rings, cylinder cock parts, boiler checks, fusible plugs, driving boxes, shoes and wedges, piston valve parts, slide valves, bolts, grab irons, drop-forged crank pin collars, crosshead and knuckle pins, cross-heads, brake connection rods, large castle nuts, piston rods and countless other articles will present themselves for consideration.

An adequately equipped toolroom for maintaining, storing

ord. As each requisition is received, after checking to see if correct, the various items are transferred to the respective cards. Thus a record is available at any time showing the material due at any point on the system, as well as the date the order was received. When material is shipped, applying on the requisition, it is recorded on the card, directly opposite the order, together with the date and invoice number. If, for any reason, the order cannot be filled in its entirety, the balance due is recorded below in red and is further checked against in shipping. Thus orders can be filled in order of priority and a complete condensed record is available for reference.

Each month the disbursements are totaled and entered on a master record, which is illustrated. This card shows the amount of raw material on order, on hand, disbursed to shop from storehouse, receipts of finished stock from the storehouse and the monthly balance in red of both raw and finished material.

The storehouse man makes a weekly check of material which is getting low and this is checked with the master card to see that raw stock is available, and this item, judged from past consumption and the amount due, should receive preference in manufacturing. Each month also, as the cards are balanced, the clerk makes a note of those showing a small balance and these are also at that time checked for scheduling.

Work scheduling in the shop is effected by the use of a ticket which not only serves as an order for the raw material and a complete direction for the work, but also as a permanent record of the material used and its disposition.

A daily receipt is secured from the storehouse of all finished material delivered from the shop. This, combined with the data on the work schedule slip and labor performed by the piece work or premium system, affords a good foundation for cost accounting.

With an organization exercising centralized control, supported by accurate, reliable records, and aided by a thorough follow-up inspection, and backed by a conviction on the part of the management that manufacturing or centralized production is quantity production and demands a division of labor and must be treated as a manufacturing industry apart from equipment maintenance, unquestionably large economies are possible in the production of many parts required in locomotive and car maintenance.

Deliver to Mach		4-25 1917	
from <u>Storehouse</u>		730 by <u>3 P.M. 4/25</u>	
600 Am 18003			
Make		600 Am 18003	
		Cd. 15110	
Raw Stock Del'd	Finished Pieces		
4-25 200	To St. H. 598		
4-26 400	Def. Pcs. 2		
	Scrap —		
Note cause for rejection of raw or finished material on back			
<i>J. M.</i>			
Inspector			

Work Scheduling Ticket

and making the necessary tools is an important feature which must not be overlooked. Limit gages, check gages, and, if possible, a Johansson standard gage set should be part of the equipment. A system should be developed for stor-



SELECTION OF MACHINE TOOLS

BY WILLARD DOUD*



THE character of machine tool equipment is one of the principal items which determine the quality and quantity of work turned out by any railroad shop. Aside from efficient supervision and labor and good material, it is perhaps the most important factor in producing the results which are sought after by every railroad executive and by which the ability of every mechanical department official must ultimately be judged. In spite of the importance of good machine tool equipment in a railroad repair shop, the statement may be made without reflecting in any way on those responsible for the selection of machine tools, that too little attention is given to the details of their selection.

As a general rule, the kind and number of tools required originate with the local officers having supervision over the various shops of a railroad. Sometimes the make is specified and the list of tools wanted is submitted to the proper motive power official for his approval. Careful scrutiny of a large number of tool lists prepared by local shop officers, generally will show well diversified opinions as to the character of the machine tools required for the same class of work.

To obtain more satisfactory results in the selection of machine tools, some railroads have appointed a special man to supervise the work of selection and distribution and on one large railroad, a machine tool committee composed of two shop superintendents, an assistant purchasing agent and the superintendent of piece work, approves all tool lists and selects those to be purchased. Experience on one railroad where tools were selected by a supervisor of tools and on another by a tool committee, has convinced the writer that better and more satisfactory results to all concerned are obtained where the work is handled by a committee. One of the reasons why better results seem to be obtained with a committee is that the viewpoints of more than one individual are obtained as to the merits of tools and their suitability for a certain class of work. Also a local shop officer will, as a rule, feel somewhat better satisfied when the make of tool purchased differs from the one asked for in his original list if the change is based on the opinion of a committee of experienced men instead of that of an individual, no matter how experienced the individual may be.

Machine tools, excepting those of the bench variety and possibly the simpler forms of grinders and drills, represent considerable investment even under normal conditions and especially at the present time. This being the case, every precaution should be taken to make sure that the machine selected is exactly fitted for the work to be performed, well constructed and in every way a facility for giving the best results from both production and maintenance standpoints.

In discussing the matter of selecting machine tools with the superintendent of shops of a large railroad system some time ago, the statement was made that practically all of the tools purchased for his shop were selected from catalogs. That such a procedure was somewhat common may be gained from the presence of the formidable catalogs, issued by large

manufacturers of machine tools for railroads, which may be found in practically every shop office. These are fine examples of the ability of the illustrator and printer to produce well constructed picture books, essentially lacking in detailed descriptions of the tools illustrated. This statement is not made with the idea of minimizing the importance of using machine tool catalogs, in fact they are very important and necessary in the process of determining the type and character of the tools to be selected.

In making up a list of machine tools, free use should be made of catalogs and the fact kept in mind constantly that no one manufacturer makes all, or even the greater portion of the machine tools which are suitable for use in railroad shops. The entire list of manufacturers' catalogs, descriptive of the various tools to be purchased, should be examined in detail and if these are not available, the writer knows of no better source of information than the advertising pages of the trade journals of the railroad, iron and woodworking industries.

When a decision is reached as to the types of tools best suited to the local conditions, detailed specifications for the equipment should be prepared and sent out to manufacturers and jobbers. The preparation of specifications for machine tools is a point which is often neglected by railroads and a little time and care spent in their preparation will yield good results by making the purchasing and selection easier, surer and simpler for all concerned. The writer has used the following form of specifications in his work for some time past with good results and has selected for example the details covering a 36-in. motor driven engine lathe, together with some proposal and other requirements which accompany and form part of the specifications.

METHOD OF SUBMITTING PROPOSALS

In submitting proposals on the machine tool equipment listed in the following pages, attention is called to the following requirements which must be adhered to without variation:

1. In case the bidder does not quote on the make of the machine specified, the quotation shall cover equipment which the bidder considers equal to that specified.
2. Information covering details of each machine specified must be furnished exactly as shown in the list under each item, variation being allowed only to cover special features, of the machine quoted on, which are not contained in the specifications.
3. Where equipment is to be furnished, it must be furnished in entirety or exceptions must be noted as to any omissions.
4. Each item must be considered separately and in no event shall it be included in the same proposition with any other item.
5. The net weight of each machine shall be given.
6. Guaranteed time required for delivery of each machine must be stated specifically.
7. A print, photograph or illustration showing the prin-

* Consulting Engineer, Chicago, Ill.

cial construction characteristics and other necessary information shall be submitted with and attached to a separate sheet bearing the item number. (An example of the specifications of one engine lathe, Item 27, is shown herewith.)

8. As the railroad company may elect to purchase all electric motor equipment and deliver it to the works of the machine tool manufacturer for application, each item where motors are necessary for the operation of machine shall give the following information in full:

- a Make and type of motor.
- b Frame number and speed of motor.
- c Make and type of controller or starter.
- d Deduction for purchase of electrical equipment by the railroad company, with delivery f. o. b. machine tool builders works and additions charged, if any, for application to the machine tool.

Unless otherwise specified, the price of each alternating current motor 7½ h.p. and larger, shall include a two point

tion of the machine. The quotation shall state the length of time the demonstrator is to remain in the company's shops and no rate per day and expense basis will be considered in this connection.

The question may arise as to the necessity of going into such detail in the purchase of machine tools and the inclusion of a tabulation which is practically a copy of information obtained from the manufacturer's catalog; also as to the policy of specifying definitely the product of any one manufacturer.

To answer the first part of this statement, it may be said that the detailed description of the lathe includes all items which are of importance in considering the various machines offered for purchase and that a basis is established for assuring the same information being given for each of the various makes of tools. Uniformity and completeness of the information regarding the various tools is of immense value in comparing the quotations of the different makers and renders the tabulating of bids by the purchasing department, not always too well acquainted with the details of the machine tools, more or less of a mechanical procedure. As to the question or propriety of specifying the machine of any one manufacturer, this point is fully covered in Clause I of the above requirements and as all tools of a general character, such as lathes, planers, drills, millers, punches, shears and hammers are built along the same general line and possess all of the features mentioned in the tabulation, there appears to be no logical objection to using any one make of tool merely as a reference standard.

It is a rather difficult matter at times to decide what make of tool is best suited to certain conditions, even when all the data and information concerning the tool have been received from the manufacturer. A plan which has been found productive of good results on one large railroad in particular, noted for the care taken in the selection of machine tools, is for the tool committee or the supervisor of tools to visit other shops where similar tools are in operation in case there is any doubt as to the entire suitability of the equipment offered for consideration. While such trips of inspection may seem entirely unnecessary to some and a waste of time, the railroad in question has found them a paying investment, as certain features of construction which may look very desirable when seen in a photograph or in a catalog illustration, give an entirely different impression when seen on the actual machine in operation.

Another desirable feature of the inspection trips is that those making them see what the other fellow is doing and generally are sure to note methods which can be adapted to their home shops with profit.

There is a tendency at times to favor the installation of large tools in railroad shops when such tools are not entirely suited for repair shop service, except for certain conditions. Unless the tool is to be installed in a large shop of a large railroad system, and there is a great amount of manufacturing work to be performed, the installation of large planers, multi-head frame slotters and drills with large bed plates, multi-spindle cylinder boring machines and large hydraulic presses of the four post type, should be considered very carefully and the results expected from their operation weighed against those which may be obtained from smaller and more flexible separate units capable of performing the same class of work.

The multi-head tool with its large bed plate occupies valuable space in any shop and in the case of one shop which the writer has in mind, the better production results obtained from the installation of a multi-head frame slotter are more than neutralized by the obstruction which the bed of the tool offers to the handling of materials to and from the other machines and through the shop. Large tools of the types mentioned present a formidable appearance in a railroad shop, but in a large number of instances are "monuments"

Item 27. One Engine Lathe.

Nominal size	30 in. by 14 ft.
Make	American
Catalog reference	American Tool Works Co. No. 40
Application	General Locomotive Work
Length of bed	14 ft. 0 in.
Length between centers	8 ft. 3 in.
Swing over wings of carriage	32½ in.
Swing of carriage bridge	22¼ in.
Diameter of hole through spindle	2 9/16 in.
Size of tool	1 in. by 2 in.
Taper of centers	Morse No. 5
Diameter of small face plate	15 in.
Diameter of large face plate	30 in.
Diameter of spindle nose	5 in.
Threads per inch on spindle nose	2
Number of spindle speeds	12
Range of spindle speeds, r. p. m.	6-260
Diameter of lead screw	2¼ in.
Threads per inch on lead screw	1
Number of feed changes	48
Range of feed changes, cutting	5-280
Range of feed changes, threads per inch ..	2-28
Type of rest	Compound
Travel of compound rest	9 in.
Kind of drive	Motor
Current and voltage of motor	Alternating, 440 volts
Type of motor	Slip ring, constant speed
H. P. and speed of motor	10 hp. 1200 r. p. m.
Frequency of motor	60 cycles
Type of motor control	Reversing wheel mounted on carriage

In addition to the special wrenches and other tools necessary for operation of machine, the following equipment shall be furnished: One steady rest; one follow rest; full swing rest attachment; taper attachment; thread dial attachment, and one 24-in. combination universal and independent "Wescott" chuck, threaded to fit the spindle.

auto-starter or compensator with no-voltage release attachment. The necessary controller equipment shall be included in the price of direct current motors.

9. Failure to comply with any or all of the above requirements may result in no consideration being given to the item or items in which omissions or variations occur.

Protection of Hazardous Parts.—Special attention is called to the desirability of having effective protection on all gears, belts, or other rapidly moving parts which may be considered as hazardous to the machine operative or other employees. All protective devices shall be of neat design and shall be made and applied at the shop in which the machine is manufactured. Effectiveness, accessibility to parts protected, permanency and neatness of the design will be the points considered in judging the merits of protective devices. Other things being equal, the machine giving the most effective protection to operatives and others will be given preference.

The protection furnished shall satisfy all requirements of the State Department of Factory Inspection and any adjustments or additions to the machine proper, necessary to meet these requirements, shall be made at the expense of the machine tool builder.

Services of Demonstrator.—In the price of machine tools of a special nature shall be included the services of a demonstrator for a sufficient length of time to fully acquaint an employee of the railroad company with all details of opera-

to the questionable judgment of the officer responsible for their selection.

A point of importance in the selection of machine tools for railroad shops which must not be lost sight of is that a certain type of tool which is suitable for one railroad may not be suitable for another road for the same class of work. Modern machine tools of the better class are designed to meet conditions which exist in shops where production is pushed to the limit. Where shop labor conditions are such as to limit the production of a machine as compared with its

possibilities where there are no restrictions, the more expensive type of machine is not always justified. A simpler and lighter machine will meet all requirements fully as well with a lower investment in the tool.

The number of points which should be considered in the selection of machine tools for railroad shops are legion, and other things being equal, the best service results will be obtained where the greatest degree of care has been exercised in the selection of a machine to meet certain shop conditions and to perform a certain class of work.



POWER TESTS OF MACHINE TOOLS

Determinations of Average and Maximum Driving Power
And Power Wasted by Friction, Made on the N., C. & St. L.

BY C. H. CRAWFORD

Assistant Engineer, Nashville, Chattanooga & St. Louis

THERE is a great amount of data available regarding the original cost and the cost of operation of individual motor drive for machine tools in new shop installations. However, comparatively little information can be found concerning the substitution of individual motor drive for group drive in existing shops, and with a view to securing data on this subject the tests described below were conducted.

At the present time the Nashville, Chattanooga & St. Louis has a large number of tools in its machine shop at Nashville which are driven in groups from line shafting run by electric motors. In the planing mill the machinery is also driven by line shafting, the power in this shop being furnished by a steam engine. It was thought that a saving could be effected by the substitution of motors for the planing mill engine, and as group drive could not be applied readily, individual motor drive was considered. This brought up the

which made the adoption of individual motor drive seem advisable were, the possibility of saving by having a centralized power supply, the elimination of losses due to the friction of shafting, which took place whether the shops were running under full load or not; increased output of machines made possible with motor drive, greater reliability and greater safety. Owing to the high first cost of motors it was considered best to group some of the smaller machines so that several could be driven by line shafting from one motor.

There seemed to be no doubt but that individual motor drive would give better results from the standpoint of shop operation, and in determining the advisability of making such an installation the question to be decided was whether the saving in power and labor would justify the investment required. For the purpose of ascertaining the economy which would be effected by the change tests were con-

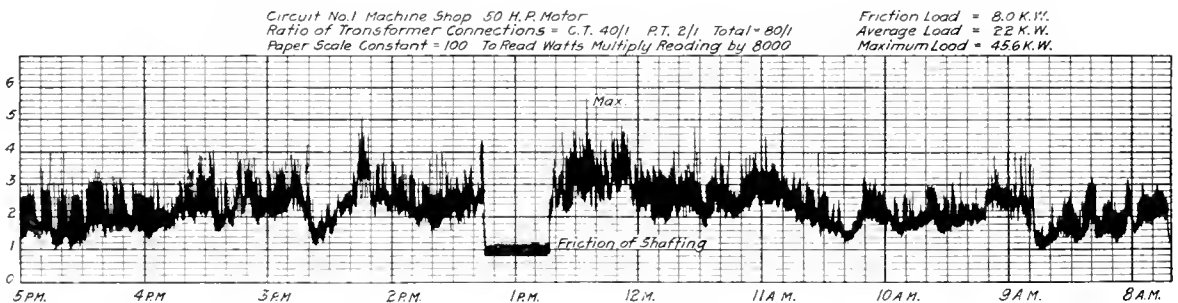

Fig. 1.—Sample of Chart Taken in the Shop Power Tests on the N. C. & St. L.

question of the advisability of changing the tools in the machine shop also from group drive to individual motor drive.

The problem which was investigated in this case is one with which engineers are often confronted and the details of the method show a practical way to arrive at a logical solution, while the results obtained may be of interest as an indication of what might be expected under similar circumstances. The prices of the motors in the tables were secured sometime ago and would now be somewhat higher, but since there has been a corresponding advance in the cost of fuel and wages, the change will not affect the results to any great extent.

In the particular cases under consideration the factors

conducted on practically all the machine tools in the shops, the friction horsepower, the maximum and the average horsepower under load and the starting torque at maximum load being determined. The power required to drive the shafting was determined separately. The power used by the groups of machinery in the shop was measured by inserting a polyphase graphic recording wattmeter in each circuit and taking records, as shown in Fig. 1, for from three to six days in succession in order to get a fair average of the power consumed.

The chart which is reproduced was taken on one of the power circuits in the machine shop and shows the variation in the power consumption during one working day. The record for the morning is on the right hand side and that

for the afternoon on the left hand. Between the two is the record for the noon hour which represents the friction of the shafting only. It will be noted that while the maximum load was 45.6 kw. and the average only 22 kw., the friction

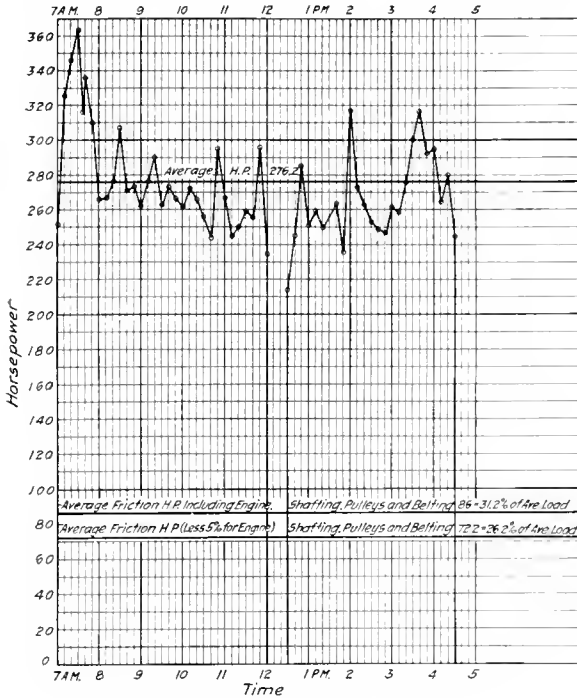

Fig. 2—Horsepower Chart for the Planing Mill

load was as much as 8 kw. or 36.4 per cent of the average load.

The power used by the planing mill machinery was found by taking indicator cards from the engine at intervals of ten minutes, from which the horsepower was calculated and a curve of horsepower for the day plotted, as shown in Fig. 2.

were mounted on a truck, as shown in Fig. 3, with the control apparatus between them. The wiring diagrams for the motors are shown in Fig. 4. The shafts of these two motors were fitted with bushings of the same outside diameter and

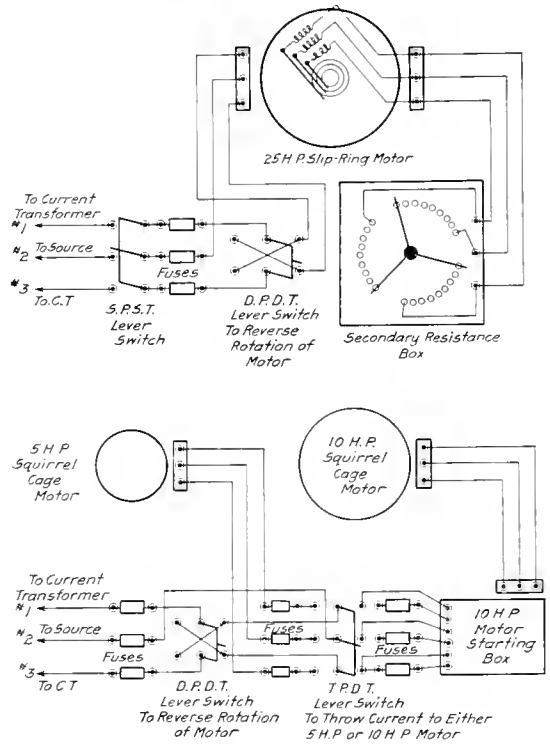

Fig. 4—Wiring Diagram of Motors Used to Determine the Horsepower Required by the Machine Tools

having keyways so that wood pulleys ranging from 5 in. to 14 in. diameter could be used on either motor. The electrical apparatus for recording the power input to the motors

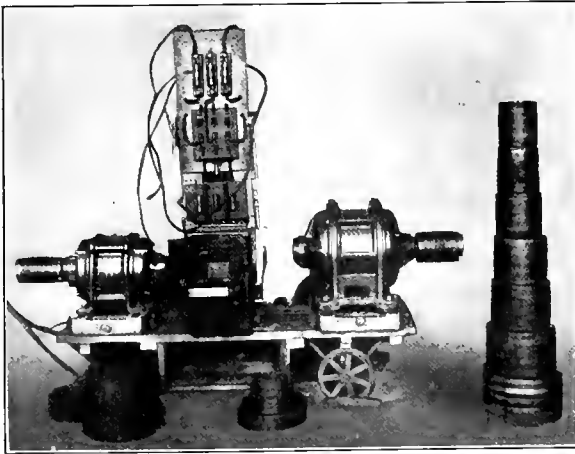

Fig. 3—Portable Motors for Testing the Machine Tools

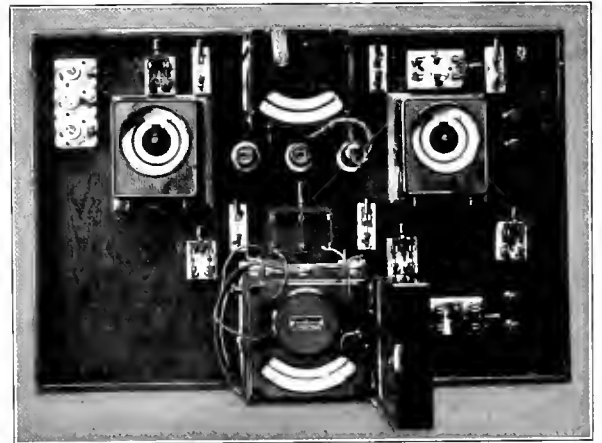

Fig. 5—Plan View of the Meter Table

It will be seen that in this shop also there was a large amount of power wasted in friction and windage of shafting and belts.

In testing the machine tools in the shop three motors were used, one of 5 hp., one of 10 hp. and one of 25 hp. To facilitate the work of testing the 5-hp. and 10-hp. motors

were mounted on a portable table. The plan view of this testing table is shown in Fig. 5, while Fig. 6 shows the method of wiring instruments. A record of the machine was taken on a form which provided for general data concerning the machine as well as the results of the test and the method of connecting the motor which was best adapted to each tool. The

data taken on the test of the individual machines included the friction horsepower and the average and the maximum horsepower while the machine was in operation. To assist in selecting the type of motor best suited to the machine the starting torque was measured by attaching a lever to the driving shaft of the machine and moving it by a pull on the lever at a fixed distance from the axis of the shaft, the force required being measured by a spring balance.

the shop was working was found to be 59.6 hp. The friction load of the shafting and belts was 35.2 hp., or 37 per cent of the average gross load of 94.8 hp. In the planing mill the average gross indicated horsepower was 276.2. The friction horsepower of the engine, shafting, pulleys and belting was 86 hp., or 31.2 per cent of the average gross load. Allowing 5 per cent for the engine friction gives 72.2 hp. for friction of the shafting, or 26.2 per cent of

TABLE II—SUMMARY OF TESTS ON MACHINE TOOLS AND COSTS OF MOTOR DRIVES.

Description of machine.	Shop No.	Friction H.P.	Average H.P.	Max. H.P.	Starting torque.	Description of load.	Test motor		Motor recommended		Type control.	Cost of motor.	Cost of control.	Installation and change by machine.	Total cost.	
							H.P.	Eff. to	H.P.	Type.						Speed.
22 in. cut-off saw.....	A1	0.5	2.8	3.4	22	3 in. diameter steel.....	5	CTR	5	SCCS	1,200 GM	IM	\$97	..	\$20	\$117
Power hack saw.....	A2	0.6	small to	test successfully—group with 64 and 60 (inside).....	10	CTR	5	DCAS	1,800 GM	PFA	265	\$81	20	366
Boring mill.....	B1	0.8	5	5.6	24	1/4 in. cut by 3/16 in. feed.....	5	M	5	SCCS	1,800 GC	IM	54	..	15	69
56 in. boring mill.....	B2	0.8	4.6	4.9	56	3/16 in. cut by 1/24 in. feed (cast iron).....	5	M	5	SCCS	1,800 GM	IM	265	81	20	366
41 in. boring mill.....	B3	0.7	4.6	4.9	56	3/16 in. cut by 1/24 in. feed (cast iron).....	5	M	5	SCCS	1,800 GM	IM	265	81	20	366
Cylinder boring machine.....	B6	0.8	2.8	5	135	3 tools 5/8 in. to 7/8 in. cut, 3/64 in. feed.....	10	CTR	5	SCCS	1,800 GM	IM	76	..	20	96
Taper bolt machine.....	C1	(could not test; estimated)
4 1/2 by 6 ft. radial drill.....	D1	0.1	2	2.1	22	1 25/32 in. hole (wrot iron).....	5	MC	5	SCCS	900 GM	IM	162	..	35	197
26 in. by 40 in. radial drill.....	D2	1.4	2.1	2.2	..	1 13/16 in. (steel).....	5	CTR	5	SCCS	1,800 GM	IM	76	..	20	96
24 in. by 4 ft. 8 in. radial drill.....	D3	1.4	2.1	2.2	..	1 13/16 in. (steel).....	5	CTR	5	SCCS	1,800 GM	IM	76	..	20	96
18 in. by 20 in. drill press.....	D6	(could not test; estimated)
24 in. by 48 in. radial drill.....	D10	1	1.5	1 13/16 in. hole (wrot iron).....	5	M2	2	SCCS	1,800 GM	IM	54	..	15	69

KEY TO ABBREVIATIONS.

CTR—Countershaft overhead. MC—Countershaft on machine. M—Belted directly to machine. SCCS—Squirrel cage, constant speed. DCAS—Direct current, adjustable speed. SRVS—Shp ring, varying speed. IM—Included with motor. PFA—Push button automatic. GM—Geared directly to motor. GC—Geared to countershaft.

NOTE—The starting torque was taken at the machine shaft.

From the data thus secured it was possible to select the type of motor which should be applied to each machine tool and the cost of the motor, including installation on the machine, was determined. With these data and the saving in power known it was possible to calculate the saving which could be effected by the use of the individual motor drive. The following are the results of the tests made on some typical machines:

TABLE I.

Description	Hp.	Average Hp.	Maximum Hp.	Description of load
90-in. wheel lathe.....	4.5	17.0	19.5	3/8-in. cut, 1/16-in. feed
36-in. engine lathe.....	0.4	5.6	6.8	3/8-in. cut, 1/32-in. feed, steel
22-in. engine lathe.....	0.3	3.0	4.3	3/16-in. cut, 1/32 in. feed, cast iron
Double head axle lathe.....	1.2	11.8	14.3	3/8-in. cut, 1/16-in. feed, steel axle
3-in. turret lathe.....	0.7	1.3	2.6	13/16-in. bolts
26-in. by 8-ft. planer.....	1.9	4.3	5.6	5/16-in. cut, 1/16-in. feed, cast iron
48-in. by 12-ft. planer.....	0.8	4.6	11.7	3/4-in. cut, 1/32-in. feed, cast iron
28-in. draw cut shaper.....	0.2	3.5	4.5	3/8-in. cut, 1/32-in. feed, cast iron
Wheel boring mill.....	0.6	7.1	7.7	1/4-in. cut, 3/32-in. feed, cast iron wheel
44 in. boring mill.....	0.7	4.6	4.9	3/16-in. cut, 1/24-in. feed inside; 1/8-in. cut, 3/16-in. feed outside, cast iron
Cylinder boring machine..	0.8	2.8	5.0	3 tools, 3/4 in. cut, 3/64-in. feed
18-in. by 30 in. slotter.....	..	4.0	4.9	1/4-in. cut, 1/64 in. feed, wrought iron
24-in. by 4 1/2-in. radial drill	1.4	2.1	2.2	1 13/16 hole, steel
Emery wheel.....	0.4	2.4	..	Dressing lathe tool
Hydraulic press.....	0.9	4.4	..	Pressing on tank wheels
Hydraulic press.....	0.6	4.3	5.6	Pressing off drying wheels
22-in. metal cut-off saw.....	0.5	2.8	3.4	Cutting 3-in. diameter steel

PLANING MILL	Average Hp.	Maximum Hp.	Description of load	
16-in. by 20-in. sill dresser	4.0	9.5	23.0	Cutting one side oak 2 1/2 by 8-in. to 1 7/8 in. by 8-in.
Timber sizer.....	29.0	48.0	62.0	Cutting four sides
Double surfacer planer.....	8.5	19.5	21.0	1 3/4 in. by 10-in. oak
Hollow chisel mortiser.....	4.0	5.9	14.2	2-in. chisel, 4-in. deep
Wood turning lathe.....	0.1	1.3	..	5-in. diameter piece
Band saw 5-in.....	8.5	18.0	24.0	Cutting 10-in. oak
16-in. rip saw.....	1.2	8.0	8.6	Cutting 3-in. oak
16-in. cut-off saw.....	1.2	6.3	..	Cutting 1 3/4-in. oak

From the records of the individual machines a summary was made as shown in Table II.

SUMMARY OF TESTS AND COSTS OF MOTOR DRIVE.

In the machine shop the net average power required while

the average gross load. Assuming 85 per cent efficiency for the individual motor drive, an average of only 293 hp. would be required for the machine shop and planing mill, a saving of 78 hp., or 21.1 per cent.

From the data given above the investment required to change the machines to individual motor drive was cal-

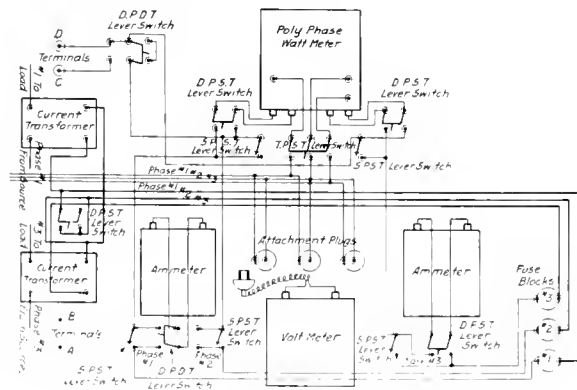

Fig. 6—Wiring Diagram of the Portable Electric Meter Table

culated. To this amount was added that portion of the original cost of the present equipment, less its scrap value, which had not already been provided for in the sinking fund. The fixed charges on this amount were added to the operating costs for the individual motor drive, and this compared with similar figures for the present equipment. The calculated saving in yearly expense after all charges had been met and the costs per horsepower under the present and the proposed system had been considered amounted to 14 per cent on the investment. It will be seen from this that a considerable saving is effected by the adoption of the individual motor drive in this case, aside from that resulting from better lighting and the greater reliability and increased output of the machines.

DEVELOPMENTS IN RAILWAY SHOP TOOLS

A Brief Survey of the More Important Improvements Introduced Within the Past Few Years

COMPARATIVELY few radical improvements have been made in railway shop machine tools and equipment in the past few years. Minor improvements, in the interest of the safety and convenience of the operator and increased output, have been made on many of the standard machines and not a few have been strengthened better to meet the requirements caused by the continued and more extensive use of high speed steel cutting tools. In general the most important development in machine tools has been the tendency toward centralized and more convenient control.

The safety first campaigns have been responsible for innumerable improvements in the direction of making tools and equipment foolproof and as safe as possible. The effect in general has been to secure much neater and more attractive designs and arrangements. Gears are covered over; belts and revolving wheels and parts are boxed in. The use of eye protectors for machinists and grinders, and in some cases helmets for the latter, remind one of the increased value which is being placed upon the human welfare and the fact that the human element is recognized as the vital factor in controlling shop efficiency and output.

There have been many applications of grinding on locomotive and car repair work during recent years. Many of the machines were homemade, as is indicated in the article on "Increasing Output and Reducing Unit Costs," which will be found on another page of this issue. There has also been a more general use of the larger and more important types of grinding machines for work such as grinding valve and piston rods, pins, journals, car wheels, and flat work such as guides, etc. There should be still greater use for grinding machines as the railroads give more and more attention to the centralized manufacture of parts. The possibilities of grinding machines in the locomotive shop are indicated by the article in this issue discussing the use of grinding and milling machines at the Juniata shops of the Pennsylvania.

The introduction of autogenous and electric welding processes in railway repair shops is undoubtedly the greatest single advance which has been made in railway shop practice in recent years. Not a few roads suffered severe disappointment in the early stages of the development of these welding and cutting processes because of a lack of knowledge of the limitations of the various systems and as to the fundamental principles underlying their use. Gradually, however, the difficulties have been overcome, one by one. The competition between the autogenous and electric systems was rather strong at one time and unreasonable claims were made in the interests of each system. As the advantages and limitations of each became better known, however, it was recognized that both could be used to advantage in the same shop, each on the classes of work for which it was best suited.

A typical expression of opinion as to the advantages of the autogenous and electric welding systems in railway shops follows; it is taken from a letter of a motive power officer: "By far the greatest help that has been given to railroad shops, in my opinion, has been the introduction of electric welding and oxy-acetylene welding and cutting. For instance, at ——— we now have five men constantly employed repairing broken or worn parts, many of which would formerly have been sent to the scrap and others repaired by other methods at much higher cost. The practice of welding

locomotive tubes to the back flue sheet has practically eliminated the delays and failures to engines on the road due to leaking tubes, and has enabled us to retain a set of tubes in a boiler in heavy service for the maximum period allowed by law—three years—where formerly they would not last more than 18 months because of the frequency of work performed on the firebox end of the tubes. This also results in longer life of tube sheets, many of which were formerly removed because of cracking at the upper flange, due to elongation caused by frequent prossering of tubes."

A job done on a milling machine may be so accurately and smoothly finished as to require no fitting. Manufacturers find that it makes practically no difference in the rate at which the work is turned out or in the finish, whether $\frac{1}{8}$ in. or $\frac{1}{2}$ in. is removed from a heavy casting or forging at one cut. This is an important factor where, as in a locomotive building shop, for instance, it is possible to use the same castings or forgings for several classes of locomotives, with the exception that the amount of material removed may differ for each class. The universal milling machine has always been indispensable in the tool room, but the tendency in railroad shops is to use the other types of milling machine more and more throughout the shop. It has been found, for instance, to give excellent results in such work as machining connecting rods and heavy castings and forgings. A still larger place will be found for the various types of heavy milling machines with the advent of still greater standardization of locomotive parts and the centralized manufacture of these parts.

Articles relating to the use of the milling machine in railroad shop practice will be found elsewhere in this issue. The use of a slab miller for finishing shoes and wedges was described in the *Railway Mechanical Engineer* of March 17, page 147. Those who are especially interested in the efficiency of milling machine cutters may wish to refer to an article on milling machine efficiency by Owen D. Kinsey, tool foreman of the Illinois Central, which was published in the *Railway Age Gazette, Mechanical Edition*, of November, 1914, page 593. A report on milling cutters was presented before the convention of the American Railway Tool Foremen's Association in 1912 by A. R. Davis, of the Central of Georgia. (See *American Engineer* of 1912, page 423.)

Recent years have seen the extensive introduction in railroad repair shops of the reversing motor drive for planers. Because of the severe and peculiar demands on the motors many engineers were skeptical as to the successful application of the electrical drive for this purpose when the first experiments were made not many years ago. Today, however, it is taken as a matter of course and is said to provide not only a better regulation of speed but more accurate stops than where belts are used for driving.

The vertical turret lathe, because of its adaptability and the multiple tool head, is enjoying wide popularity and is said by some locomotive repair foremen to be the best all-around machine tool available. With the use of a universal chuck, such as has been developed in the Richmond shops of the Chesapeake & Ohio and which was described in the *Railway Age Gazette, Mechanical Edition*, of May 15, 1915, page 239, it is possible to machine driving boxes and rod brasses at a rate never before equalled

Grinding
Machines

Milling
Machines

Autogenous
and
Electric Welding

Reversing
Motor Drive
For Planers

Vertical
Turret
Lathe

on any other type of machine, and this is accomplished with ease and convenience. These machines are especially adapted for finishing valve and piston packing rings, cylinder heads and similar jobs, far surpassing the best records which can be made in doing these jobs on large engine lathes or the ordinary boring mill.

The more recent and advance types of radial drills that have been introduced are ideal from the standpoint of convenience, quick changes, and wide ranges of speeds and feeds. Today the cutting tool is the limiting factor in production on these machines, rather than the machine itself. If equipped with suitable boring bars and jigs these drilling machines are admirably adapted for boring because of the possibility of making rapid set-ups and changes in the position of the drilling arm.

The railroads, in the interest of economical production, must give more and more consideration to the centralized manufacture of standard parts which may be either completely or partially finished in accordance with the conditions which govern their use. While

there has been a decided tendency in this direction it has hardly as yet gotten more than well started. Automatic machines will be more and more necessary as this tendency develops. Set screws and studs can be made from bar stock much more cheaply than on an ordinary turret lathe, while many small parts, such as cylinder cocks, oil cup covers, oil cups, etc., may be made on a chucking automatic.

The combination milling, boring and drilling machines have demonstrated their usefulness for various types of railroad shop work and with the improvements which have been made looking toward further convenience and facility of operation promise to become still more popular.

The shaper has been still further developed to meet the heavy service required of it in connection with the use of high speed tool steel, and in order to hold its own in competition with other types of machine tools. The draw cut shaper has demonstrated its value for railroad shop work and has made possible large savings in those classes of work for which it is peculiarly adapted.

Turret lathe manufacturers have given considerable study to railroad shop requirements and this has resulted in special sizes and adjustments to suit the different types of work. The value of these machines has been increased on those roads that have been most successful in the extensive standardization of locomotive parts.

The advantage of an accurate control over the temperatures in tempering tools is so great that the electric tempering furnace should be far more extensively used in railway shops. It has been found, for instance, that a difference in temperature of 50 deg. will practically entirely destroy the usefulness of a tool. The difficulty of determining by observation a small difference of this kind at temperatures varying from 1,000 to 2,000 deg. requires no comment. The problem has been complicated by the introduction of different varieties of high speed steel, each of which requires its own special treatment. The electric furnaces used for tempering tools at the Burnside shops of the Illinois Central were described in the *Railway Mechanical Engineer* of August, 1916, page 423. The Committee on Shop Practice of the Association of Railway Electrical Engineers, in its report for 1915, presented data covering the costs of tempering by means of the electric furnace. These may be found in the *Railway Age Gazette*,

Mechanical Edition, of November, 1915, page 590. B. Henrikson, when tool room foreman of the Chicago & North Western at Chicago, presented a discussion on the tempering of tool steel in an electric furnace before the 1912 convention of the American Railway Tool Foremen's Association. This paper was published in the *American Engineer* of August, 1912, page 426.

The ease of control, the possibility of arranging machine tools to the best advantage from a production standpoint without reference to line shafts, and the readiness with which ample power may be provided to suit the requirements for each individual tool, have been responsible for the extended use of individual motor driven machine tools in railroad shops. Where the group drive is used for tools in a new shop the groups are usually small and made up of tools that are operated at one speed or with very few changes of speed; in such cases the group drive is placed where it will not interfere with the operation of the cranes over the heavy machine section.

It is necessary to say but little as to the use of re-rolling or reclaiming rolls in railway shops. If recent years have been marked by any radical development in railway shop practice it has been in the movement for the reclamation of scrap material. There has always been a more or less plentiful supply of scrap rod material suitable for re-rolling and even though there may not be enough of this kind of work to keep the re-rolling rolls in operation for but a small percentage of the time, it has been a paying investment. In recent months it has been most difficult to buy the smaller size rods from the manufacturers, and some of the roads have secured their entire supply at a reasonable expense by re-rolling scrap material.

The output of an individual or of a machine tool may be greatly reduced by the use of improperly designed or poorly maintained tools. This has resulted in the standardization of shop tools of all kinds with special provision for repairing and sharpening them on the part of the tool room forces. Moreover, a very considerable saving has been made in the first cost of these tools by manufacturing them in quantities at a central point and distributing them over the system.

Railway shops, at least the most modernly equipped ones, have given much attention to crane facilities with excellent results. Until the last few years, however, the ordinary hand truck has been used universally for transporting material over the floor. This is not only awkward but requires a large amount of labor. The introduction of the electrically operated truck has proved a wonderful convenience in those shops which have adopted it. With the increasing scarcity of laborers and skilled mechanics the use of these trucks will undoubtedly receive additional impetus.

The introduction of autogenous and electric welding has been the most important development in the boiler shop. The improved handling of tubes is also extremely important and is referred to elsewhere. The effect of the federal boiler inspection law has resulted in many cases in improved facilities for repairs and inspection in both the boiler shop and engine terminals. Because of the failure of brazed joints on injector steam pipes the federal locomotive boiler inspection department has recommended the use of a mechanical joint and this has resulted in the development of a special machine for making such joints, known as the banding and beading machine for injector pipe couplings.

High Duty
Radial
Drill

Electrically
Driven
Tools

Automatic
Machines for
Manufacturing

Reclaiming
or Re-rolling
Rolls

Milling,
Boring and
Drilling Machine

Standardized
Shop
Tools

Shapers

Shop
Transfer
Trucks

Turret
Lathes

Electric
Tempering
Furnace

Boiler
Shop
Methods

The forging machine has made possible really remarkable economies in smithshop operation. The combined ingenuity of the foremen and their assistants in devising dies and formers has made it possible to many times increase the output of the smithshop with the same number of men, thus proving an important factor in helping to offset the steadily increasing labor costs. Too much credit cannot be given to the ingenuity and resourcefulness of the smithshop forces in developing dies and formers for peculiar and most difficult types of work, which a few years ago were performed by slower, cumbersome and more expensive processes.

The scarcity of high speed steel and the advance in prices has made it necessary to conserve its use to the greatest possible extent. Solid high speed steel tools have been practically done away with and special tool holders have been designed to utilize small pieces. This has even been carried to the extent of providing special holders to utilize broken twist drills for lathe cutting tools. (*Railway Mechanical Engineer*, January, 1916, page 44.)

Even these methods, however, result in a certain wastage and methods have been devised for welding high speed steel tips on soft steel shanks. To reduce the cost of making these welds and overcome failures under heavy cuts because of the uncertainty of hand welding, some roads have arranged for making these welds on forging machines. (*Railway Mechanical Engineer*, February, 1916, page 88.)

In the *American Engineer* of July, 1912, an article was contributed by the late L. R. Pomeroy describing the layout and tools for an ideal boiler tube department. This equipment was designed to handle 450 tubes a day at a labor cost not to exceed three cents a tube from engine to engine. The files of this publication since that time show that Mr. Pomeroy's plan was no idle dream and it was with not a little satisfaction that he saw its success actually demonstrated. Possibly no one department—if we except the reclamation of materials—has had such a general toning up in the last few years as the boiler tube department. The handling of superheater flues has also made it necessary to install tools and appliances for handling the larger diameter tubes.

Forging
Machines

Conservation of
High Speed
Steel

Boiler
Tube
Machinery



IMPROVE RAILROAD EFFICIENCY

Increase the Mileage of Locomotives and Cars. Make Repairs to the Equipment Promptly and Thoroughly

THE executive committee of the American Railway Association Special Committee on National Defense has issued the following circular to the railroads of the country outlining ways to increase the efficiency of the railroads:

The European war is responsible for conditions that have caused very large increases in traffic on American railroads, whose capacities are now overtaxed, and they are unable to respond promptly to all demands made on them. In other words, there is a demand for transportation that is not being supplied, and it becomes the duty of your committee to suggest how the present high efficiency of American railroads might be still further raised so as to increase the supply of transportation units with existing plant, forces of skilled and unskilled labor, and supplies of fuel and equipment which cannot be increased because the demand for all of these far exceeds the supply.

Your committee prefaces its suggestions by saying that to many roads they may be unnecessary, but they are offered to all in the hope that they may find them helpful.

It is also recognized that some of these suggestions will increase operating costs, but their purpose being to increase the capacity of the plant the result is deemed to justify sacrifice in a national emergency.

MOTIVE POWER SHOULD BE CONSERVED

1. About 15 per cent of locomotives are ordinarily under repair; if this percentage were reduced to 10, which figure has been reached by some roads, it would mean an addition of 3,325 locomotives to the number in service.

2. The average miles run per day by a locomotive is 75. If by quick turning at terminals, double crewing or pooling, improving the quality of water which may enable a locomotive to double a division without loss of fuel and time involved in cooling down, and with less boiler repairs, this mileage can be increased to 90, which is now reached on some roads, it is equivalent to adding 13,300 to the locomotive equipment.

3. Close attention to boiler repairs enables the locomotive to carry full steam pressure, develop full power at all times, and avoid reductions of pressure demanded by weakened boilers with consequent loss of tractive power.

4. Constant and close inspection of firing methods which will reduce the escape of combustion units in heavy black smoke, also waste of steam blowing off when locomotives are standing, will save fuel and conserve much of it for useful work. During each second a locomotive is "popping" a quarter of a pound of coal is wasted, i. e., a lump of about two inches cube. Careless or ignorant use of steam by the locomotive runner may easily waste a ton of coal on a 100-mile run.

5. Locomotive tractive power falls very rapidly as speed is increased; 20 per cent to 30 per cent more freight can be hauled by limiting the speed and utilizing the full tractive power of the locomotive at 12 or 15 miles per hour. A locomotive is a traveling power plant, 20 per cent to 30 per cent of whose power output frequently is wasted by non-use after generation, either through ignorance or carelessness, in not giving the locomotive its full rated load or in unnecessarily high speed.

6. Excite a spirit of emulation by reporting and circulating the money value of waste of power generated in locomotives and not used.

7. Defer scrapping light locomotives which might be used in branch or light main line service. This will conserve motive power for moving freight.

INCREASED CAR EFFICIENCY

The efficiency of cars can be increased by:

- (a) Quicker terminal handling and prompter loading and unloading.
- (b) Better loading—more tons per car.

1. From statistics lately collected, the average time consumed by shipper and consignee averages a little under two days each,—a total of about four days per trip of a freight car for both loading and unloading. This was under the

old demurrage rules, and those now in effect should reduce this time to about 3½ days. Under the old one dollar straight demurrage rule the average detention, including free time of a freight car when in the hands of a shipper or consignee, was 1.73 days. In California, under the \$3 demurrage rate, it is about 0.97 days, or about one-half.

2. There are 2,350,000 railroad owned freight cars in the United States and about 225,000 privately owned freight cars, a total of 2,575,000, of which about 6.5 per cent, or 167,000, are normally under repair; close watching and prompt repair work can reduce this percentage to 4, which would release 64,000 cars for active service.

3. The average miles run per freight car per day is 25. Increasing this to about 30 miles, or 20 per cent, is equivalent to adding 515,000 freight cars, or 20 per cent, to existing equipment.

4. Reduce idle time in city and freight division terminals by prompt despatch of trains.

5. Load and unload both company freight and commercial freight promptly—the first, by close inspection and by disciplining offenders; the second by personal appeal by local agents, division and assistant superintendents, and district traffic officers, to shippers and consignees, all of whom can aid greatly by explaining difficulties and obtaining the co-operation of railway patrons in overcoming them through an appeal to their friendship and patriotism. The expenditure of much time, patience, and even money, to make the reform easy in the beginning, is fully warranted. Some one or two consignees can always be found who will co-operate, and once the possibility of accomplishing the desired end is demonstrated, others will quickly follow. There are probably from 250,000 to 300,000 points in the United States where freight is received and delivered. A slight improvement at each will make an astounding aggregate.

6. Increase car loads, which have not kept pace with increase of car capacity, notably in the case of box cars, as shown below:

Average capacity of all cars.....	39.7 tons
Average load per car, all cars, revenue freight.....	15.5 tons
Average load per car, all cars (including company freight).....	17.0 tons
Per cent of capacity utilized.....	43 per cent

7. Enlist the interest and co-operation of shippers in loading cars heavier as a war measure, using the services of local agents, superintendents and assistant superintendents, traffic officers, etc., to approach them, concentrating effort on a few friendly ones at first to lead the movement and set the example. Urge shippers and consignees not to ship beyond their ability to promptly handle. Point out the importance to shippers of extending private sidings to correspond with their increased traffic and in improving their facilities to avoid car delay, and, where possible, to arrange their shipments so as to be made uniformly and at periods of the year when cars are least needed to move crops. Require reports of local agents of percentage of cubic and weight capacity of cars loaded at their stations, both as to carload and less than carload freight, also reports of waste in use of cars received by them light-loaded. Publish the results of loading monthly, to excite a spirit of emulation, which will soon affect every agent on the line. Freely interchange with connections reports of light-loaded cars, to correct inefficient loading.

8. Load all cars to 10 per cent in excess of their marked weight capacity. An increase of two tons per loaded car would be equivalent to adding over 200,000 cars to the number available for public use.

9. Where many sheep or hogs are handled, use double-decked cars.

10. Urge traffic officers to make strenuous and concerted effort to get the consent of the public to increase carload minima, thereby increasing the weight of commercial units.

11. Where commercial units are half or less than half the capacity of the car and two shipments are destined to

the same point, persuade the shipper to load the two shipments in the ends of the same car.

12. Consolidate under-loaded merchandise cars at designated transfer points.

13. Reduce in every legitimate way empty car haul.

14. The increased number of freight cars available for service without any outlay of capital through (a) quicker repairs—64,000, (b) quicker movement 515,000, (c) heavier average loading 200,000, totals 779,000.

IMPORTANCE OF TRAIN-LOADING

1. Move company freight and supplies so far as possible on trains that cannot otherwise carry full tonnage. Operate work and construction trains as far as possible in slack times. Store company fuel in slack times.

2. Substitute where possible mixed train service for separate passenger and freight train service on branch lines. Separately review the number of scheduled freight trains operated where tonnage is insufficient to fully load them, with a view of reducing the number to trains actually needed.

3. Make the question of train loading one of primary importance, with division officers, train and yard crews through closely checking, at least weekly, records of train performance, giving publicity to them.

IN GENERAL

1. One of the greatest opportunities to increase car efficiency lies in better control of an unusual traffic movement through placing embargoes promptly so as to avoid congestion and delay. The importance of keeping yards and terminals, especially in large cities and at seaports, clear of accumulations which cannot be handled expeditiously, cannot be over-estimated. The experience of the past year has shown that the number of cars held in such accumulations, together with those unduly detained by shippers, have been the chief causes of car shortage. The importance of this question demands the closest possible attention on the part of transportation officers, so that freight which cannot be moved will not be loaded in cars.

2. The executive committee has announced a policy as to car service and has entrusted to the Commission on Car Service the duty of making that policy effective. Unless all carriers co-operate loyally and completely little will be accomplished and the railroads of the United States will be foredoomed to failure in a national crisis. We must recognize that although our railroads have carried a record-breaking traffic since the commencement of the war in Europe, there have been many delays and shortage of service for which they have not been altogether responsible, but which nevertheless have sorely taxed the forbearance of the public. Following these vexing conditions our country has entered the war, which increases and intensifies them.

The committee realizes that it is difficult to obtain the maximum effect of these suggestions because of the great demand for men in all industry and for government service. It is, however, believed that the American railway man is as patriotic as any other, and will help in this national crisis.

You are urged to have meetings at division points with officers and employees where the seriousness of the national situation can be explained verbally and the greatest interest aroused in this subject of increasing the ability of the American railroads to furnish a larger quantity of transportation with the present plant. This is a result to which it is the patriotic duty of every man in railroad service to contribute his maximum effort.

You are also urged to use the forces of the freight and passenger departments in having meetings with commercial bodies and with shippers so as to enlist their aid.

3. *To our railroads and their officers is presented the opportunity of showing what they can do for their country, and your committee appeals to you to make extraordinary efforts to demonstrate what can be accomplished by the 262,000 miles of our railroads in co-operative and unified service.*

FUEL ASSOCIATION CONVENTION

Report of the Ninth Annual Convention Held in Chicago
May 14 to 17. Recommendations for Fuel Economy Adopted



THE ninth annual convention of the International Railway Fuel Association was held at the Hotel Sherman, Chicago, May 14 to 17, with W. H. Averill, general manager, New York Properties, Baltimore & Ohio, presiding. The meeting was opened with a prayer by Rev. Reginald I. Raymond. In his address Mr. Averill spoke of the importance of the work of the association at this time and urged that definite action be taken so that as a result of the convention economies in the use of fuel might be put into practice at once wherever possible.

Arthur Hale, vice-president, Consolidation Coal Company gave an address on how the coal shortage has been influenced by the car shortage, stating that for the benefit of both the railroads and the public the mines should be furnished with an ample supply of coal cars.

MR. MODERWELL'S ADDRESS.

C. M. Moderwell, of the sub-committee on coal production of the Advisory Committee of the Council of National Defense, addressed the convention on the coal situation and the war, saying in part:

This war is an industrial game, and nobody is doing any more towards the conducting of this war than you men who stay in your places and see that transportation is furnished. If there is anything we need in this country right now it is coal and transportation.

New England's coal supply, which amounts to about 20,000,000 tons, has been borne by water very largely. It comes from Newport News, Norfolk and Baltimore either by steamer or it is transported in barges hauled by seagoing tugs. The necessities of the government may be such that the government will take the tugs and steamers. The coal to New England will then have to go through Poughkeepsie, Albany and Troy from the Central Pennsylvania coal fields. These points are very congested—are absolutely blocked from one end to another.

Another serious situation is the far Northwest, including some parts of Western Canada. The railroads and the industries and the consumers in that country are in serious and dire distress, or, if not now, they will be when winter

comes on. The coal for that country is supplied by Pennsylvania, West Virginia and Kentucky, taken by rail to Lake Erie ports, thence by water to Lake Superior and thence by rail to destination. But this year that production is not going to be adequate. If we get 65 per cent of the coal on the docks when navigation closes this fall, we will be doing extremely well. That means that 8,000,000 or 10,000,000 tons of the coal that is necessary for the railroads and for the industries in that country must come from other fields, largely from Illinois and Indiana, where the transportation facilities and the coal mining properties are already overburdened and can hardly take care of the burden they are carrying now.

Secretary Lane told the committee in plain language that before winter comes America must assume the burden that England has carried of furnishing coal to Italy and France. Now, somewhere and somehow you have got to get the coal. It is a problem of production and transportation. Just how those two items can be brought to co-operate is something that I cannot say at the present time.

This war is a challenge to all of us. We have had 150 years of peace and independence, and if we cannot out of that 150 years prove to the world that we are what we claim to be, and we have had the reputation of being, the greatest organizers in the world, then there is not very much hope for our country.

SUGGESTIONS FOR FUEL ECONOMY

During the convention the association drew up a set of suggestions which, if carefully followed, will have a direct and immediate effect on fuel economy. These suggestions are given in full below:

TO ALL RAILROAD OPERATING OFFICERS

The following suggestions are given for the purpose of calling attention to certain things that can be done immediately to prevent waste of fuel on railroads:

1. Run engines over two divisions wherever possible, in order to avoid waste of coal at ash pits and firing up. See that ash pit delays before fires are cleaned are reduced to

the minimum, reorganizing ash pit forces to provide continuous fire-cleaning service.

2. Work out despatching schedules for all freight trains and have engines ordered for schedule time. If trains or engines cannot be made ready, adjust the schedule to save engines standing around under steam, wasting coal.

3. Increase the supervision and direction of the engine crews, and particularly that of new firemen.

4. Give fuel the same supervision that is usually given to the lubricating oil performance. Four or five scoops of coal are of value equal to one pint of valve oil.

5. Adopt a standard size of scoop shovel, preferably one of small size, which has been found the most economical for all ordinary conditions.

6. See that the use of fuel at power plants is given proper supervision.

7. Detail men to check car loading at mines and at scale stations.

8. Impress upon train despatchers and train crews the necessity for eliminating delays on sidetracks and at meeting points, as far as possible.

9. See that fuel statistics are comprehensive and that they are properly analyzed by division operating and mechanical department officers, so that improper conditions may be promptly corrected.

10. Insist on all transportation officers paying particular attention to the use of fuel. Impress them with the importance of the subject, and that it is more necessary to follow up fuel matters than overtime or other details of operation, from a dollar-and-cents standpoint, as well as from the standpoint of the present fuel shortage.

11. Division superintendents should hold staff meetings to consider the subject of fuel, and in addition instruct their staff officers to hold frequent meetings with engineers, trainmen and others, gathering them together a few at a time in special meetings in order to emphasize to them, the necessity of eliminating waste in the handling and use of fuel. When the group meets, mechanical department officers can review the instructions as to proper handling of engines, firing and boiler feeding.

12. Endeavor to secure the co-operation of engine crews in the economical use of any class of coal the railroads may be forced to use, due to excessive demand for high-class coal that may be required for special industrial and governmental purposes.

13. Have trainmasters, road foremen of engines, fuel supervisors, and traveling firemen follow the work of engineers and firemen as closely as possible, insisting upon engine crews practicing economy and carrying out instructions.

14. Issue instructions to engine crews to take a full tank of coal at all mine coaling stations.

15. Have coal chutes inspected to see that coal chute aprons are so arranged that coal will not be spilled on the ground and wasted.

16. Old ties, old car material, shavings, or any other available material should be used to fire up locomotives, thereby saving coal and conserving forest products.

17. Wherever practicable, store coal so as to help balance the tonnage and to reduce empty-car mileage. In storing coal, select coal of a quality that will not deteriorate rapidly, and locate storage piles where coal may be delivered to engines direct, saving a secondary handling and extra depreciation, if possible.

18. See that coal when stored is so handled as to not be broken up unnecessarily during the process of unloading.

19. Place storage coal on level ground so that it can be picked up free of non-combustible material.

20. Endeavor to have shipper put up coal trestles so that cars may be released quickly.

21. Canvass all industrial coal trestles to see if any can be secured for storage of railroad fuel at points where storage space is required.

22. When purchasing fuel for stoker fired locomotives obtain the largest size screenings the stoker can handle.

23. One large railroad has obtained excellent results by allotting for all engines the amount of coal to be used between time of firing up and leaving terminal. For yard engines similar allotments have been made for the entire period of service. It is suggested that this plan be given a trial.

TO ALL ENGINE HOUSE OFFICERS

1. Have coal shoveled ahead on tenders at terminals remote from the mines, and put no more coal on the tanks at such points than is necessary to take the train back to the terminal nearest the mines.

2. Insist that tenders be not overloaded with coal, avoiding waste on right of way and labor at coaling stations incident to picking it up.

3. Have tools and supplies placed on locomotives before the crew reports, in order to avoid delay at leaving time.

4. Maintain fire door openers, so that they will operate properly.

5. Where fire doors are not equipped with automatic openers, see that provision is made so that the door can be swung open easily and will stay latched open when firing is done in rounding curves, and so that the door can be swung shut easily after each scoop of coal.

6. Maintain brick arches properly in all locomotives.

7. Remove injectors that are oversize and replace them with those of proper size.

8. See that all coal burning locomotives have an air opening in ash pans equal to not less than 14 per cent of the grate area.

9. When locomotive fires are cleaned, see that a competent man inspects the firebox by entering it, insuring that grates are fully cleaned, without broken fingers, and when grate lever keepers are in place and locked that grates are level; see that arches are clean, in good repair, and of standard length. See also that flues are clean and free from leaks, giving particular attention to superheater flues.

10. Do not permit locomotives to be held under steam unnecessarily. When necessary to hold engines bank fires. If held for 24 hours remove fires.

11. When engines under steam are not to be fired up within twelve hours, see that the stacks are covered to hold the temperature.

12. Do not permit fresh fuel to be placed in the firebox of locomotives unnecessarily before fires are knocked out.

13. Do not permit locomotives to leave the terminal with a fire not in proper condition.

14. Maintain boilers to their highest efficiency; wash them when necessary and have the flues of locomotives bored and blown out every trip. Give special attention to the superheater flues.

15. Do not allow locomotives to run with mud ring or front end air leaks. This leakage represents a considerable waste of fuel.

16. Make a special inspection of all locomotives to see that the exhaust nozzles are opened up to the largest area consistent with the proper steaming of the locomotive.

17. Make certain that steam pipes and superheaters are tested at frequent intervals.

18. See that cylinder and valve rings are examined at least once each month, and keep the valves squared up on all locomotives.

19. On oil-burning locomotives maintain all piping, valves and operating fittings in good condition. Keep the burner clean and in proper alignment, making periodical inspections of burners to determine if defective. Pans must

be maintained in good condition and rigidly secured to avoid air leaks at sides and front behind brick work. Inspection should be made each trip to insure brick work being in good condition and all carbon and sand removed. Keep air openings free from slag and carbon accumulations.

20. The flues in an oil burning boiler require the same attention as a coal burner. Dampers should be maintained over all air openings, and must be easily operated.

TO ALL LOCOMOTIVE ENGINEERS AND FIREMEN

To Locomotive Engineers:

1. If your fireman does not employ the best practice, instruct him yourself and ask the road foreman or loco-

cent and increase the steaming capacity of the locomotive on hard pulls.

To Locomotive Firemen:

1. Break all large lumps of coal, so that no coal will be wasted by firing such large lumps.
2. Keep the deck clean.
3. Do not permit coal to fall off the gangway.
4. Close the fire door after each scoopful of coal is fired.
5. Do not slug the fire.
6. Three or four scoops to a fire, even with the largest engines, give the most economical results.
7. Do not shake the grates except when absolutely necessary, and then only slightly.



W. H. Averill (B. & O.)
President



E. W. Pratt (C. & N. W.)
Vice-President



L. R. Pyle (M., St. P. & S. S. M.)
Vice-President



W. L. Robinson (B. & O.)
Vice-President



J. G. Crawford (C., B. & Q.)
Secretary-Treasurer

OFFICERS OF THE INTERNATIONAL RAILWAY FUEL ASSOCIATION

motive supervisor to have a friendly talk with him, setting him right.

2. Advise the fireman as to grades, shut-off points, the length of time it is probable the train will be held in side-tracks, etc., and explain to him your manner of handling the injector, so that he can fire accordingly.

3. Endeavor to work your engine at the shortest practical cut-off all at all times, so as to obtain the full expansive force of the steam used.

4. Endeavor to feed the boiler uniformly, and do not allow the water level to rise so high that the effectiveness of the engine or the superheater will be destroyed.

5. Avoid waste of steam at pops. Injectors will take water as warm as your hand (100 degrees), and heating feed water to this temperature will save about four per

8. Do not rake the fire except to fill a hole or break up a bank. When engine is drifting, fire only sufficient amount to maintain fire in proper condition.

9. Study the problem of proper firing. Talk about it with other firemen.

10. Get all the pointers you can from your engineer, and practice the principles of proper firing as your share in helping to solve the fuel problem.

11. On oil-burning engines, sand flues often and save fuel by preventing black smoke, the same as on coal burners.

PROBLEMS WELL WORTH CONSIDERATION

It was the sentiment of the convention that investigations conducted with a view to securing greater economy in the use of fuel should be carried on energetically at this time

and the following suggestions were made with regard to such work:

The use of some portion of the vast deposits of lignite coal underlying the western territory for locomotive fuel purposes deserves special consideration, and an attempt should be made at an early date to investigate through the medium of adequate tests, preferably made in a locomotive testing plant, the possibility of extending the use of this grade of fuel in pulverized form or otherwise. The practical solution of this problem would assist in solving the fuel question on several roads serving a vast territory located remote from an existing acceptable fuel supply, reducing materially what now represents, because of the long haul, a heavy transportation effort.

The feed water heating devices now receiving serious attention from railway mechanical officers represent economical possibilities deserving of serious consideration, and tests on an adequate locomotive testing plant should be arranged to assist in the development of this fuel saving principle.

This association will continue to urge on American railroads the necessity of concerted effort toward securing, by properly conducted tests on a specially constructed test locomotive employed in a testing plant, that refinement in fuel economy which the magnitude of the problem so fully warrants, and it is recommended that an adequate appropriation for this purpose be made by the railroads, all of which would benefit by the results attained.

The co-operation of the Bureau of Mines should be requested in the matter of making a thorough scientific study of locomotive furnace conditions, the solution of the problem of slag or honeycomb formation alone warranting any effort made in this direction.

CONCLUSION

The above recommendations, if carried out in a thorough and conscientious manner, will result in effecting such saving and conservation of the fuel supply as will reflect to the credit of each individual contributing thereto, and will represent in the fullest sense an adequate and patriotic answer to the call of the President and the Council of National Defense.

THEORY, PRACTICE AND RESULTS OF FUEL ECONOMY

BY W. P. HAWKINS
Fuel Agent, Missouri Pacific

One of the largest single items of waste of fuel can occur at terminals by allowing engines to remain under fire longer than necessary, first, by too long a delay between the time they are detached from their train after arrival and the time the fires are knocked, and, second, by firing them up earlier than necessary before departure.

Any and all delays encountered in housing engines after arrival, in addition to wasting coal, reduce the time that should be used for washing out boilers and making necessary repairs, and in many instances the direct cause of engine failures can be traced to the fact that the engine, while at the terminal possibly seven or eight hours, was actually in the roundhouse but three hours. The work that must necessarily be neglected on engines by not housing them promptly, and the hours of service of the locomotives which are lost to the transportation department from such delays, should make the amount of coal lost a secondary consideration.

Dispatchers or yardmasters, whose duty it is to order engines, should be in a position to furnish the roundhouse foreman correct figures as to the time the engines are needed, and allow sufficient time to fire them up so that they can be taken out of the roundhouse in ample time to make any necessary preparation for their departure on the time of the call. This time might vary from two to three hours, accord-

ing to the facilities for handling engines and the distance and convenience of the tracks between the roundhouse and the train yard.

Firing up engines in anticipation of call is a very bad practice for many reasons, and should be permitted only in exceptional cases, where it is considered expedient to protect against delays to traffic on main line divisions. In such cases it should not be necessary to hold more than one engine under fire for protection, and this should be the engine which is due to leave the terminal first.

Where an engine is allowed to stand for a long time under fire the front end netting may become stopped up and the fire becomes dirty, which often results in the engine not steaming well on the road. Records show that many engine failures are charged to engines being allowed to leave the terminal with the fire in bad condition, with resultant loss of coal during the trip, and where it is a practice to fire up engines in advance of call, additional labor is necessary to watch the engines in order to keep the fires alive and to take care of the water in the boilers.

We know of one large terminal where such delays occurred frequently, and where the average time engines were held under steam unnecessarily was very high. The matter was handled directly with the division superintendent and roundhouse foreman, who claimed that no engine was fired up unnecessarily, and did not give much hope that any improvement could be made. The matter was not allowed to drop, however, but was checked closely for several days by a man who was familiar with all of the customs and practices in connection with the handling of engines at terminals, with the result that at the expiration of two weeks this same roundhouse foreman made a report voluntarily that he was making a saving of approximately twenty tons of coal per day by carrying out the suggestions of the fuel department.

Suppose that on any large railroad there are 20,000 engines handled at the various terminals during one month, and that each engine is held under steam an average of six hours. If it were possible to reduce this time by closer supervision to four hours per engine, there would result a monthly saving of 1,500 tons of coal, these figures being based on an average hourly consumption of 75 lb. per engine, which is considered low.

Another large waste occurs if proper attention is not given to firing up engines. If 75 shovels of coal are sufficient to raise 100 lb. of steam in order to handle the engine out of the roundhouse, 100 or more shovels should not be used. The probability is that the additional number of scoops of coal used may only result in the engine popping off several times before it is attached to the train, causing both waste and annoyance.

Every engine should have as large a nozzle as it is possible to use, and enable the engine to make steam freely. If engine is failing for steam the nozzle should not be reduced until full investigation has been made, in order to determine whether or not the engine has any other defects which might in any way contribute to the failure. A record should be kept showing the size of the nozzle in every engine, and every change made in the nozzle or front end should be reported for record. It is necessary that all joints around the front end be kept absolutely air tight, and that the area of opening in the front end netting be as large as possible. The air opening in ash pan should not be less than 14 per cent of the grate area and 100 per cent of the tube area. Insufficient air opening will likely make it necessary to operate the engine with a reduced nozzle opening. A reduction of from one-eighth to one-quarter inch in the size of the nozzle might easily cause a waste of from 2,000 to 4,000 lbs. of coal per trip over the average division.

Leaky steam pipes or nozzle-stand joints will cause a waste of 2,000 to 4,000 lb. of coal per trip. In many

instances locomotives are allowed to run until they make several failures before steam pipes are tested, and frequently are continued in service after they are found leaking by some make-shift arrangement such as bridging the nozzle or putting cement around the joints, which, at the best, is only a temporary arrangement. If this results in keeping down complaints from the engine crew there is likely to be no more attention paid to the engine until it fails again, and in the meantime it is consuming coal almost beyond the capacity of the tender. Steam pipes should be tested every time an engine is held in for repairs as long as two days or more.

Valves or cylinder packing blowing might easily cause a waste of one or two tons of coal over a 125-mile division. In addition to the waste of fuel, an engine cannot perform its service satisfactorily or haul its full tonnage rating with defects of this nature. It is considered good practice to examine cylinder packing every 30 days, as experience has demonstrated that it is not always possible for an engineer to detect a blow in the cylinders of a large engine. We know of instances which have occurred recently where this defect was not discovered until after the engines were reported failing for steam and not handling their trains successfully. After making the usual changes in the front end, and testing steam pipes without any improvement being made, the cylinder packing was examined as a last resort, and was found worn out and broken. The saving of coal and increased efficiency to be procured by examining the cylinder packing at regular intervals will, no doubt, more than offset many times the expense of examination.

Valves out of square, making it necessary for an engineer to work the engine in a longer cut-off in order to get over the road, is another serious defect which causes an excessive amount of fuel to be consumed. Tests have shown that it is possible for an engine to consume as much as 25 per cent in excess of the required amount of coal on account of the valves being out of square.

Defective, broken or burnt grates will cause a loss of from 100 to 200 lb. of coal every time an engine is fired up in the roundhouse with mine-run coal, and will cause a continual waste on the road. They also allow holes to get in the fire, probably resulting in steam failure before the completion of the trip.

Leaky safety valves do not always seem to be given proper consideration. Where safety valves which are set to pop off at 200 lb. commence to blow at from 150 to 180 lb., there is a constant drain on the boiler, and the loss of fuel from this cause is very great.

Superheater units in all superheated locomotives should be tested regularly at intervals of not more than 60 days, and where the joints are found leaking repairs should be made with the least possible delay. We have record of cases where engines lost 60 tons of coal in one month, compared with engines of the same class hauling the same tonnage over the same division, due to superheater unit joints leaking, and yet the engines performed their service apparently satisfactorily to both the transportation and mechanical officers of the division.

All tubes should be kept thoroughly clean. Investigations have shown many times, where engines are reported failing for steam, that the failure was entirely due to a large number of tubes being stopped up. We know instances where the tubes were reported to be bored out by engineers and from all indications, looking into the firebox from the engine deck, the work was apparently properly done. A closer investigation, however, developed that the ends of the tubes were cleaned out for a distance of only 10 in. or 12 in. The improper boring of tubes occurs so frequently in many roundhouses that the importance of close supervision of this work should not be overlooked.

Experience has proved that a locomotive with a tender holding from 14 to 16 tons of coal can easily lose from

500 to 1,000 lb. along the right-of-way for the first 25 or 30 miles out of the terminal, where it is a practice to overload the tenders before leaving. Large openings in the deck and around the grate shaker rigging, or over the draw-bar pin, left uncovered, will cause waste of 100 lb. or more of coal each trip over the road, and where some protection is not provided for preventing coal from falling out of the gangway on both sides another large loss will occur daily.

Fuel supervisors or road foremen of engines can easily keep a check on all defects and on their frequent trips over the road they should never lose sight of the importance of instructing engineers and firemen in the best and most economical methods of handling the engines in their charge. They should follow up the work they report and see that it is done in a reasonable length of time, and if not, take whatever steps may be necessary to assist in having it done.

Where monthly meetings are held by the division officials, the fuel supervisor or road foreman of engines of the division should attend these meetings and discuss thoroughly all matters relative to fuel economy. At such meetings much good might be accomplished by bringing up such matters as poor meeting points, long delays on sidings, and all matters which tend to the prompter movement of trains. It is considered to be a conservative estimate that any large modern locomotive will use anywhere from 500 to 1,000 lb. of coal every hour it is held on a side track.

The constant efforts of division officers should be directed toward keeping the average gross tons per train mile hauled as near to the maximum as possible. If the average gross tons per train mile are allowed to decrease, there will be an increase in the number of pounds of coal consumed per hundred gross ton miles. It has been proved that where a certain class of engine will use nine tons of coal over a 118-mile division with a train of 1,700 tons, the same engine will burn only 15 tons over the same division with a train of 3,400 tons, giving an increase of 100 per cent in tonnage hauled, with an increase of but 66 per cent in the amount of coal consumed.

As all the defects enumerated are ordinary running repairs that should be kept up daily, and can easily be completed at a cost of from \$5 to \$30, engines should not be permitted to remain in service with such defects until they have lost \$75 or more in the additional amount of coal consumed before repairs are made.

There should be some practical method in force for checking coal consumed by each locomotive daily. Such a record should be kept either in the office of the superintendent or master mechanic. This record should be consulted frequently during the month by the master mechanic and fuel supervisor, and where an engine is showing an increased consumption in pounds of coal per hundred gross ton miles, immediate action should be taken to improve on its performance. The accounting feature should receive serious consideration, in order that the amount of coal shown delivered to locomotives on performance sheets may agree approximately with the auditor's figures at the end of each month. A good method is to have each coaling station adjust the difference each day on fuel charges to locomotives, or, in other words, each coal chute should balance every day.

It is obvious that the fuel agent, or whoever is in charge of fuel economy, must have the co-operation of the mechanical and operating officers. Where results and practices indicate that such assistance is not forthcoming, he must be in position to point out the shortcomings of the parties at fault, regardless of the position they may hold on the division, and take whatever steps may be necessary to bring about the improvement and results that are desired.

DISCUSSION

The saving which can be made in the fuel used at terminals is very large. Delays on the road also add a consider-

able amount to the railroad fuel bill. The possibility of saving by better despatching should be brought to the attention of the officers in the transportation department. Coal should be carefully inspected at the mines and chutes must be arranged so that no fuel is lost when loading tenders. The steam pipes should be tested periodically, but the advisability of doing this work whenever the engine was held for two days or more was questioned.

OTHER BUSINESS

Committee reports on Fuel Tests, Powdered Coal, Kindling Fires in Locomotives, Graphic Display of Individual Fuel Records and Locomotive Feed Water Heating were also presented. The report on Locomotive Feed Water Heating is abstracted elsewhere in this issue and abstracts of the other reports will be published in future issues.

A paper on Fuel for Small Furnaces was presented by Joseph Harrington, which dealt with the construction and operation of furnaces using oil and powdered coal. A paper on Soot was also presented which took up the matter of deposits from fuel on the heating surface of boilers and emphasized the advantages of mechanical soot cleaners. The standing committee on Front Ends, Grates and Ashpans made a progress report and a report was presented on the Storage of Coal.

A. I. Lipetz, of the Imperial Russian Railway administration, told of the methods of conducting road tests used in Russia. At the closing session a resolution was adopted to the effect that the association offer its service to the Council of National Defense and to the American Railway Association. The executive committee was empowered to appoint a committee to work with these bodies. The secretary reported a large increase in the number of members, the membership of the association at the time the convention opened being 739. The president suggested that a membership more representative of both the mechanical department and operating department and of all sections of the country was desirable.

The finances of the association were reported in a satisfactory condition.

The following officers were elected for the coming year: President, E. W. Pratt, assistant superintendent motive power, Chicago & North Western; vice-presidents: R. Bradley, inspector fuel service B. & M.; L. R. Pyle, fuel supervisor M. St. P. & S. Ste. M.; W. L. Robinson, supervisor fuel consumption B. & O. Executive committee: For two years—W. C. Arter, supervisor apprentices, N. Y. C.; W. J. Bohan, mechanical engineer, N. P.; W. P. Hawkins, fuel agent, M. P.; J. D. Hurley, general road foreman, Wabash, and H. B. McFarland, engineer tests, A., T. & S. F.; for one year, H. Woods, fuel inspector, C. & S. Of the five cities from which the executive committee will choose the place for the next meeting Chicago received the greatest number of votes.

THE MACHINE TOOL SITUATION

The machine tool situation at the present time is one of great uncertainties, but to railway men, it is a sign of encouragement that the railroads have been more active in the market in the past three or four months than they have been in the past two years. Within the past few weeks a number of railroads have entered the market with inquiries. The number of roads has not been large: it has included the Lehigh Valley, the Santa Fe, the Pennsylvania, the Lackawanna, the New Haven, the New York Central and finally the Illinois Central. Nor have the inquiries been large, although the Illinois Central's list includes no less than 94 tools for shops all over its system.

The market for machine tools is uncertain for a large number of reasons, among them being the as yet unsettled matter of government contracts, the question of priority of

shipments, the demands for tools from abroad and finally the questions of prices and delayed deliveries.

The prices of tools, as is well known, are extremely high, so high in fact, that certain interests have even been able to sell second-hand tools used for many months on munitions work at far higher prices than was paid for them. Others have drawn attention to the fact that prices now are based on a cost of production somewhat higher than the selling price two years ago. Machine tool builders, in addition, are not eager to make wild guesses as to what the future will bring forth. For some time builders have been offering tools on the basis of billing at the price at the time of delivery while others are now going so far as to make contracts subject to price revision one month before delivery.

Deliveries on a great many machines are very much delayed, and the matter of delivery is further complicated by the question of priority. At the present time many builders are sold so far ahead that such tools as milling machines, radial drills, planers, boring mills, horizontal boring machines and shapers cannot be obtained this side of 1918. On some tools which are in even greater demand it would be extremely difficult to secure delivery in less than a year or even more. The demand for ship building equipment is rapidly bringing about similar conditions as to punches and shears. In fact, some of the liveliest purchasing at the present time is being done by shipbuilders.

Naturally, the practice is, insofar as possible, to grant precedence in deliveries to firms working on government contracts. Many machine tool manufacturers have been in receipt of instructions from the Washington authorities to rush deliveries to such plants. Luckily for the other purchasers of machine tools most of these plants are, as a rule, already fairly well equipped with necessary tools. That is to say, the orders from these individual firms run fairly small, but on the other hand, it is still true that there are many of these small orders, and that each such order delays deliveries to other purchasers. Some builders have even had to say that they cannot promise deliveries, but that they will tentatively set a date at which they will try to make delivery.

This brings us to the question of priority of deliveries. This is in the hands of the general munitions board at Washington which in general has prescribed that priority shall be given about as follows: To shops working on contracts for the allied governments; to shops working on contracts for the United States government; to shops working on essential commercial work, and finally to shops working on non-essential commercial work. Just where the railroads stand in this scheme of things is not clear. Presumably they are looked upon as shops on essential commercial work, for the authorities generally realize that efficient maintenance of railway rolling stock is one of the prime essentials in the war.

The buying of tools for railway shops, it is clear, is a matter receiving very careful attention at the present time. The roads that are placing orders are those that have an eye to the future and realize that now is the time to buy equipment necessary to hold them over until normal conditions are once more restored. Railway officers have been considerably impressed by the emphasis placed by the leaders in Washington on the fact that the war is going to last for years rather than months. They have read with a great deal of interest the statement of H. C. Hoover, the food administrator, declaring that "we face a conflict that may last two to five years." They are also considering carefully that new cars and locomotives will soon be harder to obtain and that it will be more and more the work of the shops to make up for the lack of new equipment by the best possible maintenance of old equipment. Whether the realization of the necessity for covering requirements for shop tools for possibly two to five years ahead will increase the buying of machine tools by railways under present conditions of prices and delivery is a question.



SHOP PRACTICE



ELECTRIC WELDING ON THE ROCK ISLAND

BY E. WANAMAKER
Electrical Engineer, Chicago, Rock Island & Pacific

The Rock Island has been one of the pioneers in the development of electric welding as applied to railroad work. The first installation was made several years ago and consisted of two single and one double Siemens-Wenzel unit. After several years' experience with these welders it was decided that it would be possible to use electric welding in railroad work on a large scale, if properly designed machines could be obtained. It had been found essential to have

welding equipment available at all points in the shops and engine houses, since it is quite certain that the advantage of the low cost of operation of the electric process is lost if the locomotive must be moved from a haphazard location to some special point where the power for welding is available. These features led to an analysis of distributing systems for the welding current and brought about an investigation of the possibility of using portable arc welding equipment, similar, so far as possible, to the portable gas welding outfits.

With the total capacity divided at each shop among several units, it appeared certain that as long as the power was available there would not be a complete shut-down of the welding equipment. Each operator would be entirely independent of the others, although as many as desired could be concentrated on any engine or job in the shop.

The operating economy of the units, while not a deciding factor, was found to be important, since at some of the shops the power plants were already loaded almost to their capacity, and at other points the cost of the power purchased from small central stations was rather high. Under these conditions the variable voltage equipment was considered the best because this type eliminates the resistance ballast from the arc circuit, thus increasing the power economy of the units to such a degree that a single-operator unit may be operated from a power line large enough to carry a 5 hp. motor.

As a result of the analysis of the requirements of the shops

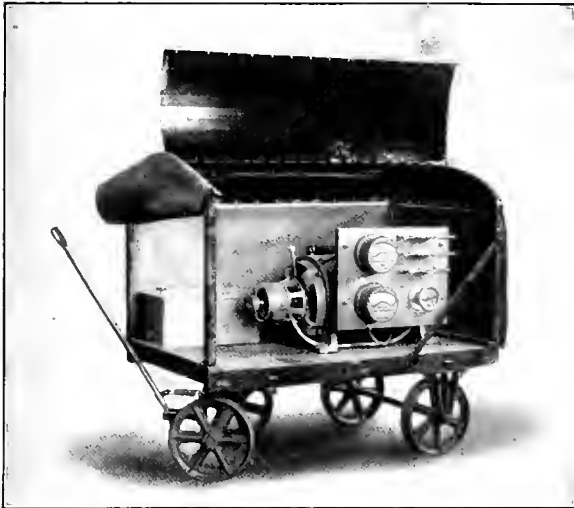

Portable Electric Welding Machine

welding machines that would permit close regulation and control of the welding arc.

In planning the installation a careful analysis was made of the service which is demanded of electric welding equipment in railroad shops and engine houses, and an attempt was made to design an installation which would show under such conditions, maximum reliability and flexibility, with minimum installation and operating expense. It appears certain that the welding process will find even a wider field of usefulness than is evident at present. This condition led to the conclusion that the present installation should be made in such a manner as to lend itself readily to enlargement should it be required. The lack of standardization of operations in the present practice made it extremely difficult to predict accurately what size installations would be required at the various points on the system, and it appeared desirable to purchase equipment which could readily be moved from one point to another, until the proper distribution could be obtained.

It was considered particularly desirable to have the arc



Welding a Front Tube Sheet

33 individual welding machines were purchased, ten of which were fixed machines to be mounted on brackets located on shop columns, while 23 were portable machines weighing, complete with the truck, approximately 1,700 lb. All of these machines are motor generators, the generators having inherent regulation. The portable machines are equipped with ball bearings which will require lubricating only once every six months. The ten stationary machines have bearings with ring oilers and are permanently located on columns in the main shop. Part of the machines

have 230 volt d. c. motors and part of them 440 volt, three-phase, 60 cycle, a. c. motors, these two power voltages being standard on the Rock Island.

As noted above, the majority of the welders are of the portable type. These have aptly been termed the "flying squadron," as they can be used at any point on the system which is equipped with power circuits. At the majority of these points the power voltage is 440. This makes it possible to reduce greatly the cost of the wiring installation, as it is only necessary to run comparatively small wires through the shops, roundhouses, etc., placing suitable receptacles at as many points as is deemed convenient, in order that the welding machines may be plugged in in a manner similar to the plugging-in of any extension circuit.

At the main shops in Silvis, Ill., there were installed, in addition to one double and one single Siemund-Wenzel welding machines, ten stationary machines. Outlets for eight portable machines were also provided. All the welding machines at this point use d.c. power.

There are seven points which have the necessary wiring completed. There are, however, fourteen additional points, where the welding machines can be connected up in case of emergency, which could be wired permanently so the machines can be used in the same way as at the points where the installation has already been made, at comparatively slight expense. In fact, most all points of any size can have the permanent wiring installed complete for \$500 or less. It is very easy to install wiring for the welding machines at the time the lighting or power circuits are being run.

it to the point at which it is needed. Immediately upon its receipt it is ready for operation.

OPERATING AND MAINTENANCE OF ELECTRIC WELDING EQUIPMENT

The installation was designed and made by the electrical department. The division electricians at the points where welding installations have been made were given sufficient instruction to enable them properly to operate and maintain the equipment, being supplied with references for ordering any repair parts that would eventually be required. As soon as possible after the installation had been completed, the supervisor of electrical equipment, accompanied by an

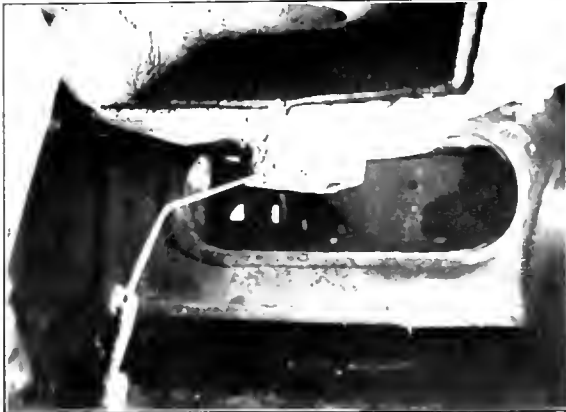

Bottom Locomotive Drawbar Pin Hole Welded



Welding Locomotive Cylinder by Welding Over Studs

expert demonstrator from the manufacturer would visit the point and instruct as many men as deemed necessary in the use of the electric arc. As is evident, these instructions are only preliminary and it is intended to continue giving instruction as frequently as possible in order to realize the full benefit from the equipments.

A complete set of instructions for electric welding has been issued, consisting of about 30 typewritten pages, to which additions will be made from time to time. These are supplied to all who are interested in the development of electric welding. The instructions begin with an explanation of the electric arc itself, continuing with the proper polarity for different classes of work. The next point covered is the amount of heat used, the kinds and sizes of electrodes and the current and voltage for the different classes of work. Immediately following are the instructions for all kinds of firebox welding, including the proper use of protective shields. This in turn is followed with complete instructions on the proper methods to use in welding frames and cylinders, and in all building-up operations.

The proper preparation of the work is fully as important as the welding operation, if not even more so. The instruction book supplies detailed sketches showing the proper method of preparing work for welding, including a detail of a small portable sand blast. Several pages are devoted to the properties of iron and steel, in order that welding may be intelligently accomplished. In conclusion there is a long list of locomotive and car parts, machine tool parts, etc., which it has been found can be successfully and economically welded.

There seems to be practically no limit to the application of electric welding when a good welding machine is intelligently used by a competent operator who thoroughly understands metals as well as the handling of the arc. The illustrations show some of the welders and a few samples of the work which has been done. The results up to the present time indicate that the net returns from the electric welding installation will be far greater than had been anticipated.

The total cost of installation per operator for the individual machines is given in the following table:

Cost per operator of multiple unit machine with a capacity for four operators, approximately	\$1,400
Cost per operator of multiple unit machine with a capacity for eight operators, approximately	1,240
Cost of individual stationary machine for 250 volt D. C., approximately	900
Cost of individual stationary machine for 440 volts A. C., approximately	980
Cost of individual portable machine for 250 volts D. C., approximately	900
Cost of individual portable machine for 440 volts A. C., approximately	980

With a system including portable machines, such as has been installed on the Rock Island, the installation of electric welding equipment is converted into a system proposition rather than a series of plants to take care of certain shops or terminals. The system is extraordinarily flexible and has many desirable features that would be impossible to obtain with any other system or type of machine. For instance, if it is found that one or more additional machines are needed at any shop it is very probable that some can be transferred from some other point, which has more than can be used to advantage at that time, and it is only necessary to pull one of these machines into a car, block it substantially, and bill

GRINDING AND MILLING WORK

Production Costs Reduced, Shop Output Increased, Accurate Work

As a means of reducing shop costs and increasing the shop output, the Pennsylvania Railroad has developed to a large degree the use of grinding and milling machines in its Juniata shops at Altoona, Pa. It has been found by several years' experience that both these types of machines have a wide range of usefulness. The milling machines will do a large amount of work cheaper and quicker

The grinding equipment on which the work to be described in this article is done consists of a large and small Norton grinding machine, a Pratt & Whitney vertical surface grinder and a Heald internal grinder. The milling machine equipment consists of two 48-in. by 17-ft. and one 30-in. by 6-ft. Niles-Bement-Pond slab milling machines, a Cincinnati, a Brown & Sharpe and a Becker milling machine.

GRINDING PINS AND RODS

The work well illustrating the economies to be effected in grinding is the finishing of all kinds of pins and rods which must have a smooth finished surface and accurate fits. The large and heavy work is done on the large Norton grinder which has a bed long enough to take an extended piston rod for a modern Mikado engine. This machine was designed especially for this work. It has a 14-in. swing and will handle work 10 ft. long and is equipped for grinding tapers. It is used to finish all crank pins, piston and valve rods and other long rods or shafting which require an accurately finished and true surface. Previous to the installation

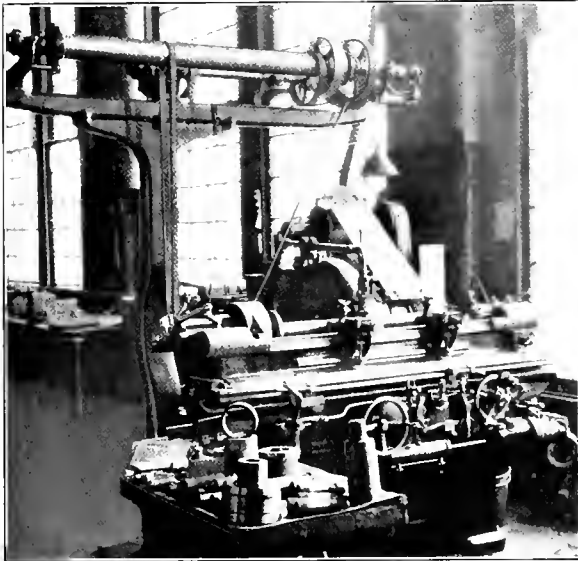

Fig. 1—Grinding Screw Reverse Screws—Other Work Done on This Machine Is Shown on the Table in the Foreground

than it can be done on a planer, shaper or slotter. The grinding machines are used for finishing work that was previously done on lathes and planers. The experience at this shop has shown that in many cases it is cheaper to take a finishing cut on a grinder after the material has been roughed out on a lathe or planer. In numerous cases the saving in the cost of labor effected by the use of grinding machines is as high as 40 per cent. In addition to this the work is more accurately done and the limits of variation from the true dimensions adhered to in this shop are quite remarkable for a railroad shop. The limits set and which are carefully followed in all the work where refinement is desired vary from .002 in. to .005 in.

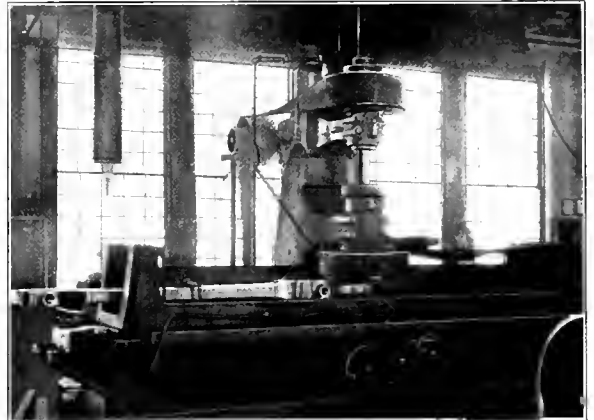

Fig. 2—Vertical Surface Grinder for Grinding Rods

of this grinding machine, the entire work on main crank pins was done on the lathe. They are now rough turned on the lathe to within $1/32$ in. of the required diameter and finished on the grinding machine, the wheel fits being ground to size, at a piece work price for the entire job 34 per cent less than that previously paid. The front and back pins are handled in the same way at a reduction in the piece work

price of 31 per cent. The saving effected in the finishing of extended piston rods by grinding is 40 per cent of the price formerly paid. This includes all work on the rod, the taper fits and all.

The smaller Norton grinder is used for the less heavy and shorter work. The work done on this machine consists of finishing the outside of the side rod knuckle pin bushings, the knuckle pin itself, crosshead pins, driver brake clog hanger studs which are tapered, the outside of the piston valve stem bushing for extended valve rods, superheater damper pistons and shafts, link and valve motion pins, screw reverse screws (see Fig. 1), lathe centers, milling machine arbors, pipe centers for lathes, the outside of bridge link bushings, taper pins for tube expanders, and so forth. Similar savings are made on this machine as on the larger grinder.

The cross-head pins are now rough turned on a lathe to within $1/32$ in. of the finished diameter and finished on the grinder at a cost 40 per cent less than when they were finished complete on the lathe. The driver brake clog hanger studs which are tapered, are now done 16 per cent cheaper than before and the prices paid for taper pins for tube expanders are about one-third as much as when these pins were finished on the lathe. All the above comparisons are of piece work prices and indicate directly the increase in shop output. In no case have the men lost money by the institution of these practices and in most cases they have been able to increase their daily net return with less labor.

VALVE GEAR MOTION WORK

The combination of both milling and grinding as practiced in these shops is well illustrated in the work done in making the various parts of the valve gear motion work. Almost this entire job is done on milling, drilling and grinding machines. The only planing done at all is on the flat of the link and link block and on the curved surfaces of the link slot and the link block. The link is planed to 1.32

in. of its required thickness, .04 in. on each side being left for grinding, while .01 in. is left on each side of the slot for grinding. The sides of the link are ground on the vertical surface grinder. The work was done previously under vertical grinder with a rim grinding wheel and the saving effected by the surface grinder is 73 per cent in the piece work price.

The surface grinding machine is used for a variety of

lever quadrants, etc. It is provided with a magnetic chuck which greatly facilitates doing the work.

The only slotting done on the valve gear motion work is to cut out the slot in the link and to cut an offset for grease cups in the lower ends of the link and radius rod. The slot in the link is cut with a narrow slotter tool, three holes being previously drilled in the link to start the work, one at either



Fig. 4—One Head of Radial Planing and Grinding Machine

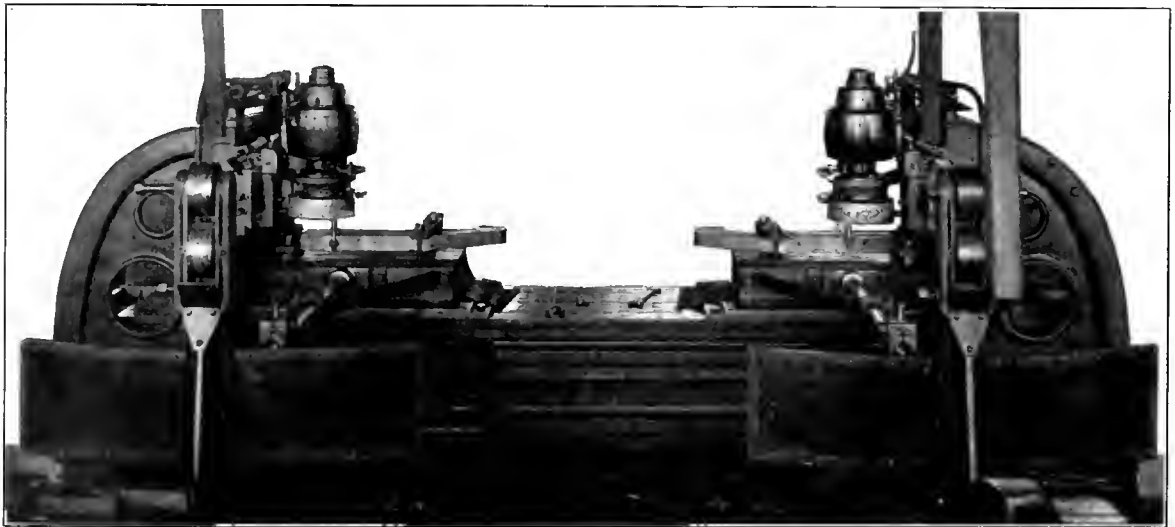

Fig. 3—Radial Planing and Grinding Machine for Valve Motion Links and Link Blocks

end and one in the middle. The edges of the links are milled in pairs in a vertical miller and later buffed on a swing grinder after the links have been casehardened. The slots in the links are roughed out on the radial planing and grinding machine shown in Fig. 3. The links are set for this operation in the illustration and by careful examination of the illustration, the planing tool will be observed just back of the grinding head and directly above the slot in the link.

Fig. 4 shows the grinding head in operation and more clearly shows the radius attachment of the machine.

The link blocks are made from wrought iron forged bars made of selected scrap. These bars are rolled cold to the approximate radius and are rough planed on the faces on a

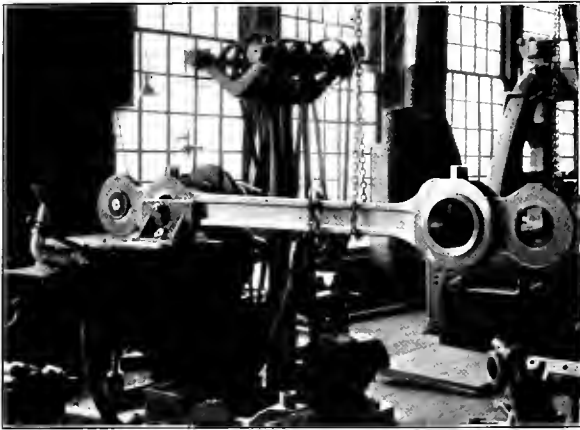

Fig. 5—Grinding Knuckle Pin Bushings in Side Rods

table planer, the edges being planed on the radial planer in Fig. 3, 1/32 in. being allowed for finish. They are then cut to length and drilled for the block pin and oil cavity. They are then casehardened. The sides are ground to dimension on the vertical surface grinder and the curved faces are ground on the radial grinder. The hole for the pin is ground in the Heald internal grinder. All grinding work is held to an accuracy of .002 in.

The various rods and links in connection with the valve

same machine. The long jaw in the radius rod is also milled, the work previously being done on a slotter.

The valve gear motion work is provided with casehardened bushings at every pin. These are ground to size after hardening, on the Heald grinder, .002 in. being the allowable variation from the exact dimension. This machine has proved very valuable for this class of work. It has a wide range of usefulness and at these shops it is used for grinding out the interior of knuckle pin bushing after being applied to the side rods (see Fig. 5), the pin hole in the link

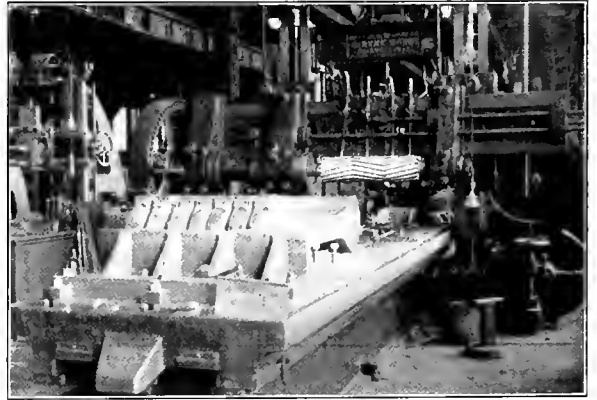

Fig. 7—Slab Miller for Machining Rods

guide block, the hole in the link and lift shaft bracket (see Fig. 6) and all other interior grinding that is necessary.

MAIN AND SIDE RODS

Both the slab and vertical milling machines are used to a large extent on the main and side rods. Fig. 7 shows a group of side rods on one of the slab milling machines, the edges having just been milled. Eight rods are milled at a

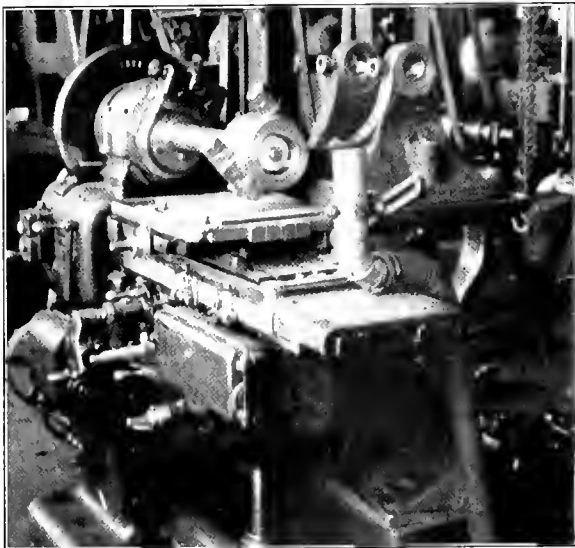

Fig. 6—Grinding Bushings in the Link and Lift Shaft Bracket

motion work are finished entirely on the milling machines. The eccentric rods, radius rods and lap and lead levers are all milled on a slab miller, as many being milled at a time as the table of the machine will accommodate. The radius rod links and the lap and lead rod links are milled on the edges and flats on a smaller machine. The ends of all the rods are milled on a vertical miller and the jaws in the eccentric rod, radius rod and the links are milled in the

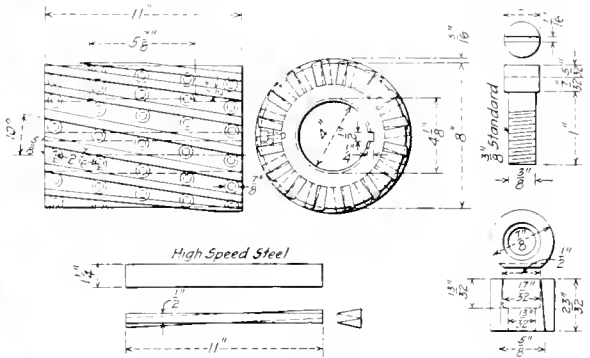

Fig. 8—Milling Cutter for Slab Milling

time. The illustration shows seven, one of the rods having been removed. The sides of the rods are milled in the same manner, two rods usually being milled at one time. The inserted tooth cutter used for this work is shown in Fig. 8. The body is made of axle steel and the 16 teeth are made of high speed steel. They are formed hot in a die to the shape shown in the drawing. They are inserted in corresponding slots in the axle steel body and are held in position by six thimbles having a tapered, flattened surface where they bear against the teeth. These thimbles are held in the body of the cutter by 3/8-in. machine screws. These cutters are 8 5/8-in. in diameter and 11 in. long. Three of them are used on one mandrel as shown in Fig. 7.

The main rods are handled in the same manner, with

the exception of the stub ends which are planed to within 1/32 in. of the required dimension, 1.64 in. from each side being removed on the vertical surface grinding machine. The channels are milled in one cut, three rods being channeled at one time on the large slab milling machine and two at one time on the smaller slab milling machine, as shown in Fig. 9. The milling cutters used for this work are shown in Fig. 10. They are similar in construction to those shown in Fig. 8. A center support made in the company's shops is applied to the machine to support the arbor



Fig. 9—Milling Channel Rods

carrying the cutters as shown in Fig. 9. Two of these supports are used when three cutters are used.

As an example of what is done by milling the rods, the following record of the milling of a channel main rod for a Consolidation engine is given:

Length over all	12 ft. 10 1/2 in.
Length of channel	10 ft.
Width of channel	4 1/2 in.
Depth of channel	1-25, 3/2 in.
Weight of rod in rough	1,985 lb.
Weight of rod finished	690 1/2 lb.
Weight of rod with fittings	886 1/2 lb.
Total weight of metal removed	1,295 1/2 lb.
Weight of metal removed from channel	535 lb.
Time required to channel a pair of rods	8 hrs.

This work was done with three milling cutters. All slotting operations are reduced to a minimum as the experience

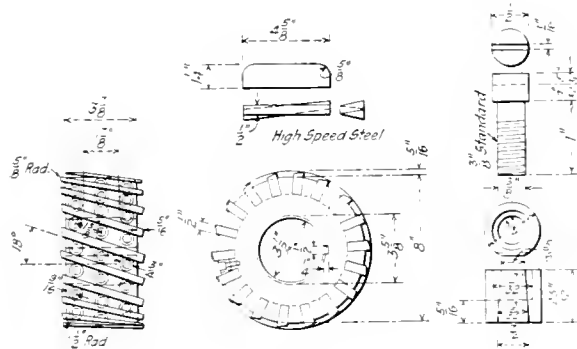

Fig. 10—Cutter for Milling Channel Rods

with the milling machine has proven it to be the cheaper practice. At the present time the slotting done consists of cutting out the rod for the pin brasses in the main rods and the knuckle jaw in the side rods. Plans are now being developed to cut out the back end of the main rod and the

knuckle jaw on the milling machine. The rods are milled to size from the rough forging, only one cut being taken on each surface. The ends of the rods are milled on vertical milling machines.

MILLING TRAILER FRAMES

Another job well illustrating the value of milling operations is that of finishing trailer frames. No planing is done on them at all. Fig. 11 shows the amount of work required to finish these frames for a modern Pacific type locomotive. Two frames are milled on the flats at one time, eight are milled on the edges at a time and they are cut to length on a slotter, five frames being cut at one time. Fig. 11

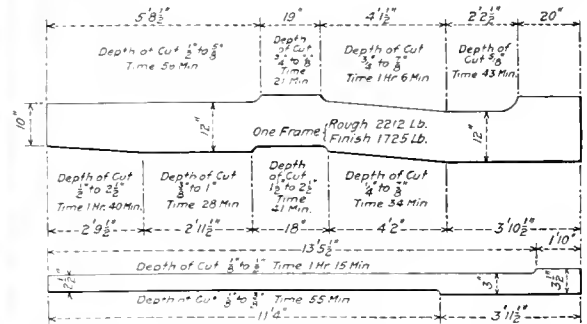

Fig. 11—Outline of Milling Work Done on Trailer Frames

shows plainly the depth of cuts taken over different parts of the frame. Only one cut is taken over the entire length. The weight of metal removed per hour of cutting time is 250 lb., and the amount of metal removed per hour is 961 cu. in. The following is a record of eight frames milled from the rough forging to the finished piece:

Amount of metal removed, edges	1,356 lb.
Amount of metal removed, flat	2,542 lb.
Amount of metal removed, total	3,898 lb.
Time taken to mill the edges	6 hrs. 29 min.
Time taken to mill the flats	8 hrs. 40 min.
Total time for cutting	15 hrs. 9 min.
Number of times the frames are chucked	13
Time taken to chuck the frames	26 hrs. 1 min.
Total time to finish the eight frames	41 hrs. 10 min.

Each frame weighed on an average of 2,212 lb. as it came to the machine as a rough forging and weighed 1,725 lb.

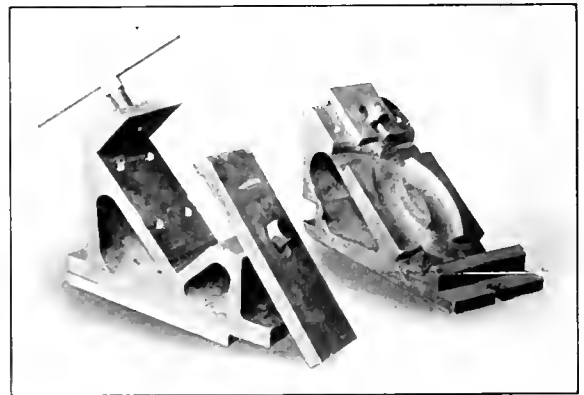

Fig. 12—Jigs for Milling Back End Main Rod Brasses

finished. Thus from each frame an average of 487 lb. of metal was removed in an average of about 5 hrs. and 9 min. from the time the work was started until it was finished.

MILLING MAIN ROD BRASSES

While the main rod brasses are planed for the rod fit and bored for the pin, the milling machine plays an interesting

part in the work done on them. The finishing of the brasses after they have been planed and bored involves the cutting of the inside corners, making the hard grease and oil grooves, rounding the corners of the flanges and cutting one flange

ners are cut with an end milling cutter (Fig. 13) with the jig shown at the left in Fig. 12. The hard grease groove is made with a small end milling cutter as shown in Fig. 14. The oil grooves are made with a saw fitted on a taper shank and set

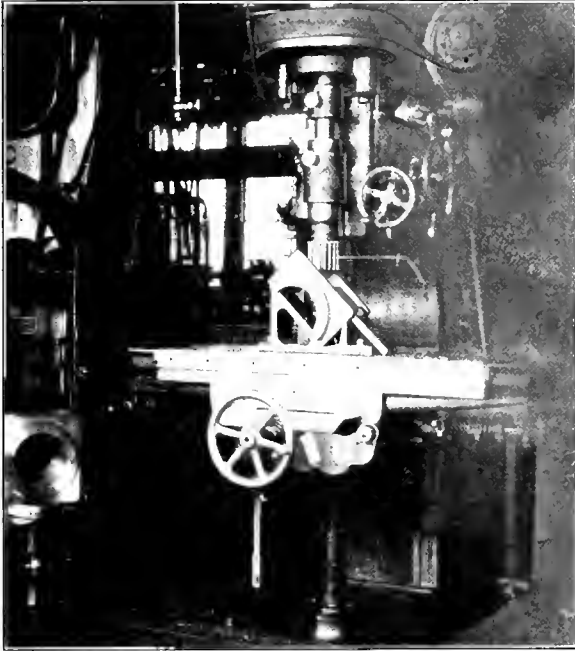

Fig. 13—Milling the Inside Corners of the Main Rod Brasses

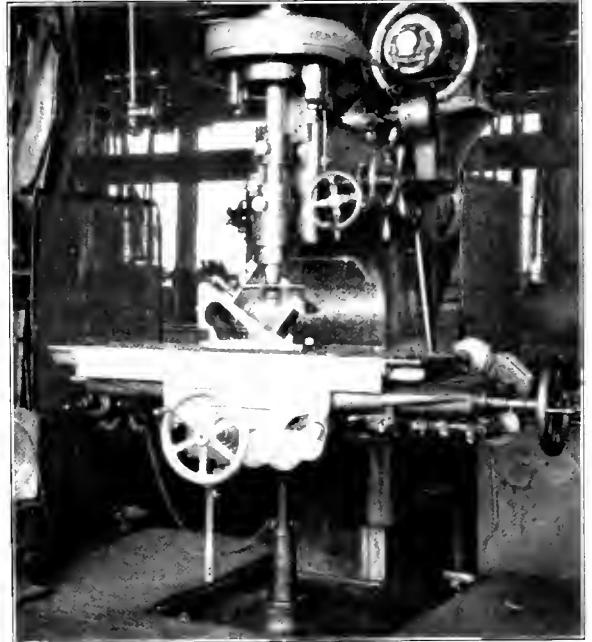

Fig. 15—Milling the Oil Grooves in the Main Rod Brasses

away to clear the rod key set screws. This work was previously done as follows: The inside corners were cut on a shaper; the hard grease grooves were made on a slotter after holes at each end of the groove had been drilled on a drill

in the spindle of the machine, as shown in Fig. 15. The jig shown at the right in Fig. 12 is used for holding the brass

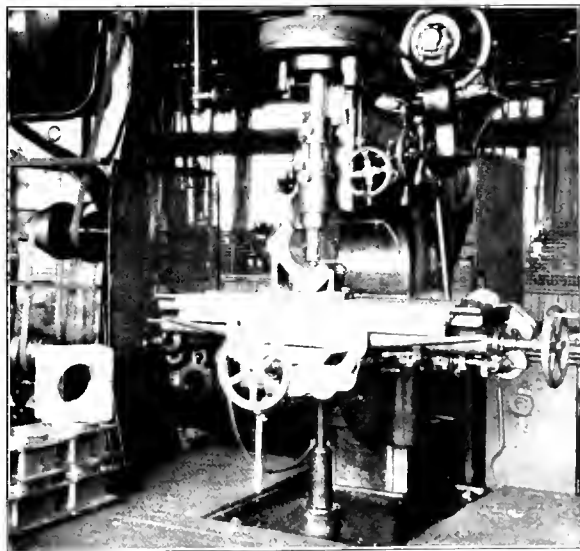

Fig. 14—Milling the Grease Grooves in the Main Rod Brasses

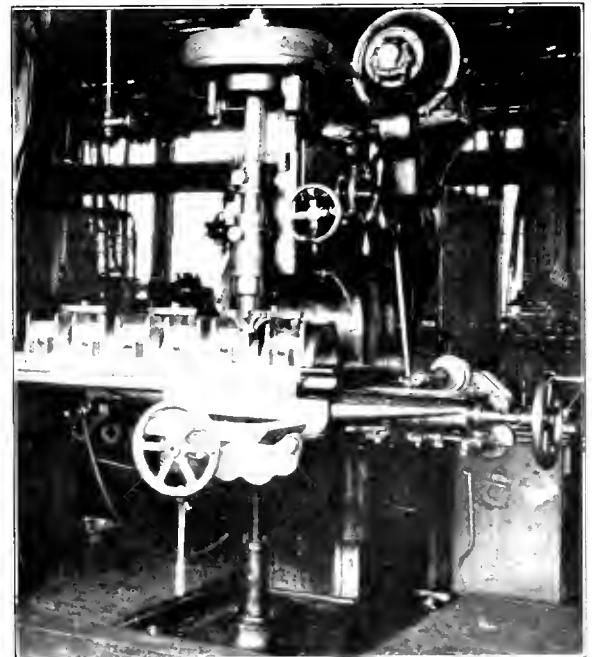

Fig. 16—Milling the Flange Corners of the Main Rod Brasses

press; the oil grooves and the corners of the flanges were chipped by hand at the bench, and the flange for the rod key set screws was cut on a milling machine.

All this work is now done on a vertical milling machine with the aid of the jigs shown in Fig. 12. The inside cor-

ners are cut with an end milling cutter (Fig. 13) with the jig shown at the left in Fig. 12. The hard grease groove is made with a small end milling cutter as shown in Fig. 14. The oil grooves are made with a saw fitted on a taper shank and set

in the spindle of the machine, as shown in Fig. 15. The jig shown at the right in Fig. 12 is used for holding the brass

for this work. It is so designed that it will hold the brass on either side, which permits milling all diagonal grooves

with the same jig. The corners of the flanges are milled with a special design of end mill to give the proper radius and several boxes are set up at one time as shown in Fig. 16. The flange is recessed, as shown in Fig. 17 with a regular milling cutter.

By doing this work on one machine a large amount of time is saved by it not being necessary to carry the brasses to different places in the shop as was before necessary, and in addition to this, the cost of doing the work has been reduced materially, the work being done for 42 per cent of what was previously paid.

ACCURATE BRASS FITS

By finishing the back end of main rods on the surface grinder and planing the fits in the brasses to the micrometer with a .002 in. tolerance, a very satisfactory job is obtained and all bench work is eliminated. The only filing done is to remove the feather edges from the rods so that the hands of the workmen will not be cut. The work is done cheaper

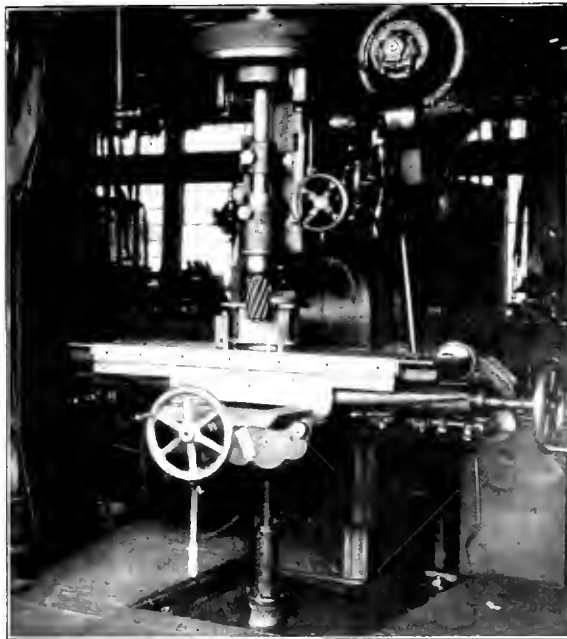

Fig. 17—Milling the Recess in the Flange of the Main Rod Brasses

by 30 per cent and the brasses are interchangeable with any rod of the same class of locomotive. The back end of the main rods are ground on the vertical surface grinding machine with the wedge block in place to bring it to the same thickness as the rod and the front end is ground with the brass in place. The accuracy sought in the brass fits is to limit the play between the rod and the brass to .005 in. The work is checked from time to time to impress upon the workmen that this tolerance must be observed, and the results of these inspections show that they are followed carefully. The last such inspection showed 80 per cent of the brass fits were within the .005 in. clearance tolerance and the greatest clearance was only .0085 in.

CONCLUSIONS

The purpose of this article is to show what is being done by the judicious use of grinding and milling machines in one shop, to decrease the cost of production and increase the shop output. The practices described will serve as a guide to those who have not gone as far in the application of these machines to their own shops. It is believed that

much more can be done in both milling and grinding than is ordinarily done, and that the future will show a wider application of these machines to locomotive work.

RACK FOR STORING BOILER SHEET STOCK

BY C. L. DICKERT

Superintendent Shops, Central of Georgia, Macon, Ga.

The photograph shows a rack which has been built at the Macon, Ga., shops of the Central of Georgia for storing boiler plate and steel sheets. There are three such racks, each containing nine bents. Each rack is made up of five sections of framework, the intermediate bents being provided by the space between the adjoining frames. The sheets thus stored require much less platform space than when placed in flat piles on the platform. When piling sheets on the platform it was necessary to put sheets of different sizes and thicknesses in one pile, thus necessitating the handling over of considerable material in order to get at the size desired. With the present arrangement the sheets are lifted out of the rack by a crane, using a safety grip for holding the sheets. They are then carried on industrial trucks to the boiler shop.

It will be noted that the bents inside of each framework are closed at the top, the adjoining bents being open. Those



Rack for Storing Boiler Plate

which are closed are used for narrow sheets, while the larger sheets are stored between the frames.

Each rack is built up on three 5 $\frac{1}{2}$ -in. by 9 $\frac{3}{4}$ -in. stringers which form front, back and intermediate sills, to which the 5 $\frac{1}{2}$ -in. square uprights are secured by 3 $\frac{1}{4}$ -in. by 5-in. strap iron knees. The three uprights on each side of each frame are braced by 2-in. by 4-in. pieces placed horizontally. The sides of each frame are tied together at the top by 2-in. by 4-in. pieces. The uprights are about 70 in. in height and are spaced 36 $\frac{1}{2}$ in. apart, the depth of the rack from front to back being 6 ft.

GASOLINE CAUTIONS.—Gasoline should be kept and used only in small quantities, and used only by experienced employees who realize the danger in using this volatile fluid and know how to handle it safely. Gasoline should be handled in small safety cans, equipped with safety gauze and safety stopper. Gasoline is exceedingly volatile and will vaporize when exposed to the air at any temperature down to 15 deg. below zero. This vapor is nearly three times as heavy as air, and when mixed with the proper quantity of air becomes violently explosive. The vapor will ignite from any open flame, even from a spark of static electricity from a human body, a spark from an emery wheel, or from a sufficiently heated surface. The gasoline vapor, being heavier than air, will naturally seek a lower level, and if confined where there is poor ventilation, will sometimes remain in an explosive condition for months.—*Compressed Air Magazine*



Increasing Output and Reducing Unit Costs

Grinding Processes Used as an Example

*By E. J. Spidy
Formerly Shop Engineer
Canadian Pacific
Winnipeg, Man.*

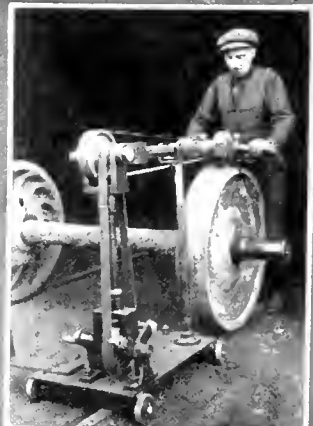

MACHINERY—strong as it is—is continually playing out, and each failure should be studied in order to make improvements. We are always interested in extending the capacity of machine tools by adding attachments or changing the construction details in order to perform some operation more efficiently.

Making a general survey of the various processes in our shops we cannot fail to note that progress is steadily being made that leads in one direction—to greater output and less cost per unit. For purposes of illustration con-

under the particular conditions that each was designed to meet.

FLEXIBLE SHAFT GRINDER

A flexible shaft grinder has been devised for use in the rod department to remove hammer marks on the straps of rod ends and for cleaning scale from straps and rods which are returned from the blacksmith shop. It consists of a countershaft mounted on a bench, to the end of which is attached a flexible shaft 1 in. in diameter, carrying a grinding wheel 6 in. in diameter and 2 in. thick; the wheel runs at a speed of 1200 r. p. m. Apart from a considerable reduction in the amount of labor, a large number of files are saved by its use. The strap or rod is set on a block at the end of the shaft, as shown in one of the photographs at the head of this article, and the operator grabs the handles on each side of the wheel and guides it over surface which is being ground.

SURFACING DIE BLOCKS

A device for surfacing or truing die blocks has been provided by attaching a grinding wheel to a vertical drill, as shown in one of the photographs. This may not be an ideal arrangement but it is the best that we could do with the material available. The forging machine die department is isolated from the main tool gang and it is often necessary to surface up dies after hardening because of warping and other reasons. In order to save considerable handling and many files we attached the fixture shown to the end of the spindle of a Foot-Burt drilling machine in the die department. It is locked to the spindle to prevent rotation. The fixture is a simple casting carrying a short spindle with a pulley for the drive on one end, and the grinding wheel on the other. An extra belt was run from the countershaft to drive the grinding wheel at a speed of 1500 r. p. m.

The die blocks which are to be surfaced are placed on the table and fed by hand across the grinding wheel; the vertical feed is obtained by means of the elevating screw under the table. This device has worked very well, but has the disadvantage of tying up the drill, and we are now converting an old universal milling machine to do this work, as shown in the drawing. The miller has power cross feeds and we have only to connect a reversing gear mechanism to the feed and arrange a permanent spindle.

PEDESTAL JAW GRINDER

The horn or pedestal jaw grinder, illustrated in one of the photographs, is perhaps not in its final stage on account of difficulty in getting the correct size cup grinding wheel. It has been tested out with a smaller wheel than is desir-

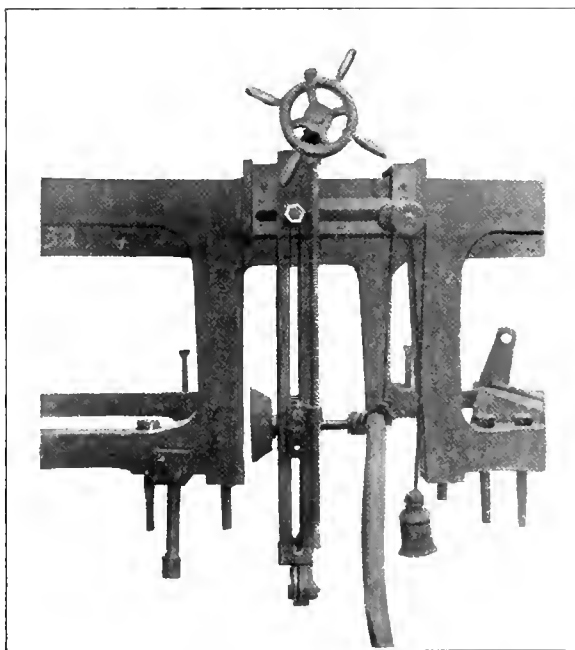

Pedestal Jaw Grinder in Place

sider the field of grinding. It would not appear that grinding had such a field in a locomotive repair shop as, for instance, in a manufacturing plant where new work is on the floor all the time, much of it being repetition work specially adapted to grinding operations. Nevertheless, during the past 12 months we have developed at least seven new applications of grinding, all of which are saving money

able with results that are exceedingly encouraging and we are convinced that it will be a happy solution for what is one of the most awkward and tiring jobs in the locomotive erecting shop. It consist of a framework which carries the grinding wheel shaft and feed mechanism. A motor is hung on the opposite side of the locomotive frame and drives the grinding wheel by a flexible shaft. The grinding wheel itself is attached to a short shaft that is held in a bearing set between two slotted frames; these are, of course, longer than the frame jaws. A screw feed mechanism allows the grinding wheel to be fed up and down when the squaring adjustments have been made. There is also a screw feed adjustment for setting the gear up to the frame marks, and a separate feed for adjusting the grinding wheel on the jaw when the side guides are lined up to the frame marks. It is not difficult to set up the device and it promises to give a smooth and accurate finish, doing away with the tedious hand work.

TRUING WELDED SPOTS ON TIRES

A grinder for truing welded flat spots on tires is similar to the arrangement ordinarily used for side and main rod polishing. The grinding wheel is driven by means of a couple of belts on a double jointed frame, the drive being from a countershaft to the floor pulley of the machine.

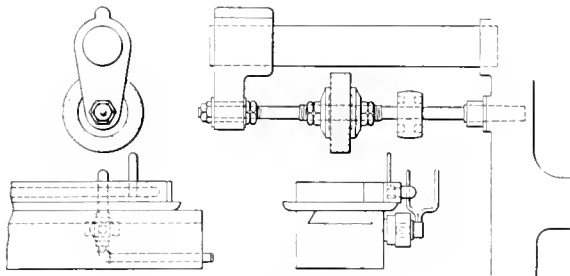

Adaptation of Die Block Surfacing Arrangement to An Old Universal Milling Machine

Handles on each side of the wheel allow it to be readily guided over the welded spot. This saves much labor, files and violent language because the flat spot is built up of wheel turnings which are often harder than the files. A drawing of this device will be found on page 212 of the April, 1917, issue of the *Railway Mechanical Engineer*; a photograph is also shown in the right hand view at the head of this article.

RAIL SAW GRINDER

The saws used on the rail saw are made of one-quarter-inch boiler plate and after a time the corners wear off. They may be much improved by being squared up again on a grinder. In order to do this a triangular table has been rigged on the tool grinding level of regular double floor grinder which is near the rail saw. This may be set up in less than ten minutes; a saw to be sharpened is dropped on the pin at the apex of the triangle frame and fed into the grinding wheel; it is turned by hand; this trues up the edges and at the same time keeps them true to the circle.

MOTION WORK GRINDER

The flexible grinder in the rod department suggested the use of a small surfacing attachment for the use of the motion work gang; this in order to rough grind work from the blacksmith shop before using a file on it. In this case the work is mostly small and a solid stand with a wheel 10 inches in diameter and 3 inches wide was equipped with an adjustable table over the top of the grinding wheel. The table may be adjusted so that just enough wheel pro-

jects to grind lightly the surface of the link blocks or other parts. Babbitt packing rings are also surfaced on a machine of this type.

GRINDING IN CYLINDER HEADS

The arrangement for grinding in cylinder heads has also been improved, and was illustrated and described in the *Railway Mechanical Engineer* of November, 1916, page 595. We had been using a mechanical crank motion for this operation for some years but the new arrangement does

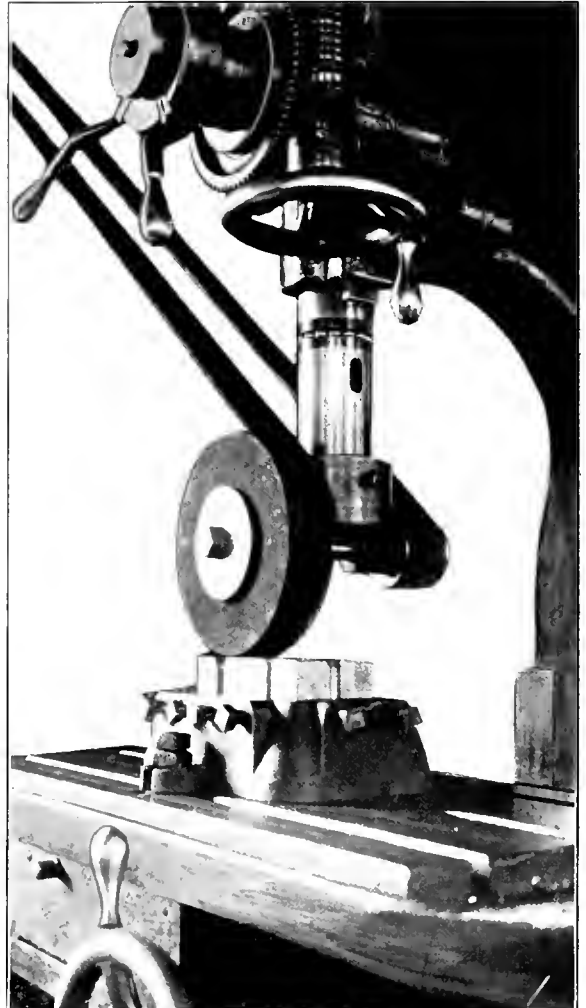

Grinding Arrangement for Surfacing Die Blocks

the work more quickly and is better because the grinding wheel is driven at a more suitable speed. For the air motor and crankgearing a Westinghouse air pump was substituted on a suitable frame. The back end of the pump is on a fulcrum and oscillates as the cover is moved back and forth.

CAST IRON CEMENT.—A cement for patching cast iron may be made of 16 oz. of finely pulverized cast-iron borings, 2 oz. sal ammoniac, 1 oz. sulphur. Mix well and keep dry. To use, take one part of the mixture to 10 parts cast-iron borings or filings and add enough water to make a stiff paste and calk it into the crack or hole to be repaired and let it set for 24 hours.—*Power.*

LOCOMOTIVE ROD JOB

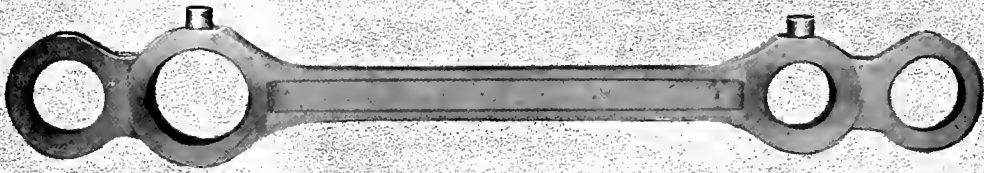

Prize Winning Papers of the Rod Job
Competition Which Closed May First

[Several contributions were received in the rod job competition. That receiving the first prize is given below. The others will be published in future issues.—Editor.]

ORGANIZATION AND METHODS FOR HANDLING RODS

BY ERNEST A. MILLER

The following is an outline of the manner in which the locomotive main and side rods may be handled economically and with despatch. The organization and plan of the machine tools is adapted for handling from 30 to 40 sets of rods of the average locomotive per month.

ROD GANG ORGANIZATION

The chart shown in Fig. 1 outlines the organization of the rod gang. In a gang of this size the foreman should

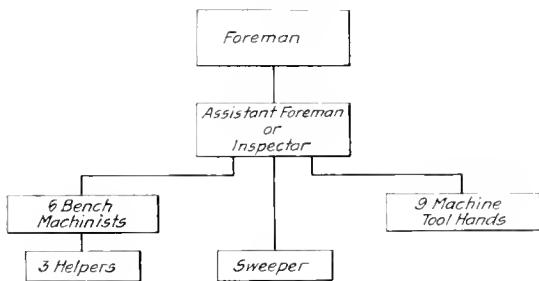

Fig. 1—Organization Chart for the Rod Gang

have an assistant foreman or inspector who should be a capable man. The six bench machinists should have three helpers, one to assist two men. The helpers remove rods from engines, clean them and deliver them to trestles at the machinist's bench for inspection and repairs. They obtain the material from the stock-room to repair the rods, take care of the crank pin and knuckle pin nuts and washers which have been removed with the rods, and do all the moving of the rods to and from the smith shop, machines and trestles and assist the machinists generally.

The six machinists should take care of both side and main rods of five to seven locomotives a month per man. Each man should take his turn as an engine comes into the shop, and he is held responsible for all repairs to both the main and side rods on that particular locomotive.

The chart also shows nine machine men, a majority of whom are first class machinists or machine hands. These men handle all the machine tool work to be done on the rods. Their duties are outlined according to the machines on which they work.

LAYOUT OF SHOP FOR ROD WORK

The arrangement of machine tools and benches is shown in Fig. 2. At the top and on the right is shown a bench for the helpers in which they store their oil, waste, wrenches, etc. Next is a bench for the six rod machinists. This bench has a chipping screen in the center 3 ft. high and it extends the entire length of the bench. Each man has a pair of trestles at his bench to hold several pairs of main rods on which he may be working and as the main rods are seldom taken off these trestles after being once put on them there is no necessity for a crane. By using the wagon shown in Fig. 3 they can be hauled to the trestle, lifted one end at a time and slid onto it. The machine-

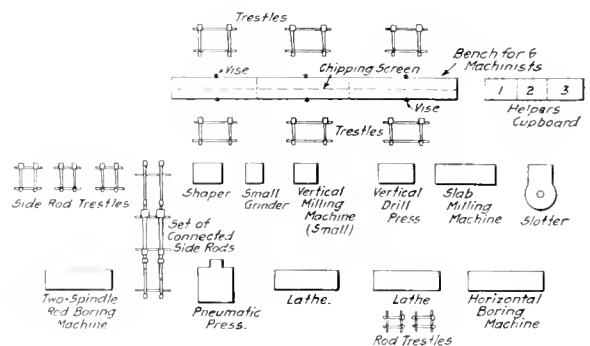

Fig. 2—Arrangement of Tools and Benches for the Rod Job

tools are located conveniently to the rod-men's benches. The work done on these machines is as follows:

Large Lathe (20 in. to 25 in.).—On this lathe all the brass bushings are rough bored and faced for stock, and when they are to be applied they are bored to fit the rods and faced to the proper width. All pin brasses are also bored and the back end main brasses are faced.

Drill Press.—This machine is used for drilling pin holes in all bolts, crosshead pins, knuckle joint pins and the oil

holes in the side rods and knuckle joint bushings. It is also used for drilling holes in the new main rods and the new side rod jaws preparatory to slotting.

Small Lathe (14 in. to 18 in.).—All knuckle joint pins and bushings are turned and bored on this machine.

Shaper.—All brasses, keys, wedges and blocks are handled on this machine.

Slotter.—The slotter is used for slotting the jaws and for outlining around the ends of the side and main rods.

Milling Machine, (small, vertical).—This machine is used for milling keyways for set screws in keys or wedges.

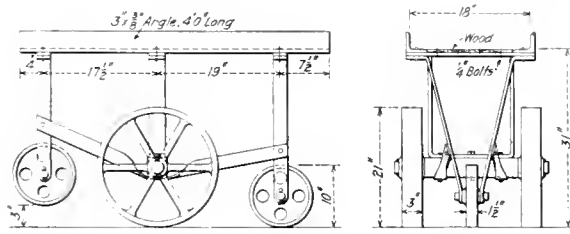

Fig. 3—Wagon for Carrying Locomotive Rods

for cutting the wrench fit on the end of newly made grease cup plugs, and for rounding one side of front end keys.

Milling Machine, (large).—This is used for milling rods to the proper thickness, and for milling the new back end main rod brasses in lots of four and six as desired, they being clamped to an angle plate.

Horizontal Boring Machine.—This machine is used for boring large holes for brass and steel bushings and for finishing the outside of grease cups on new rods.

Rod Boring Machine.—This machine is used for truing up knuckle joint bushing holes that are out of round, for boring bushings and for drilling holes through them for grease sockets.

The large lathe, on which the large brass bushings are

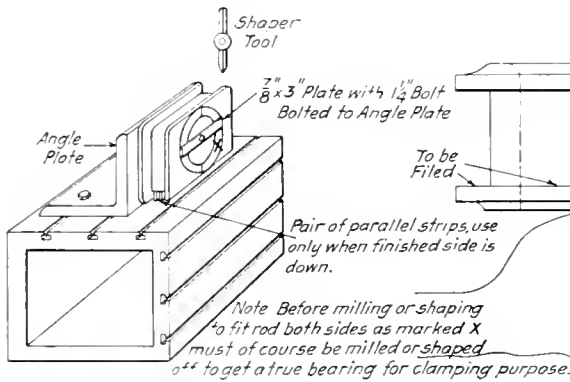

Fig. 4—Holding Brasses on Slotter Table

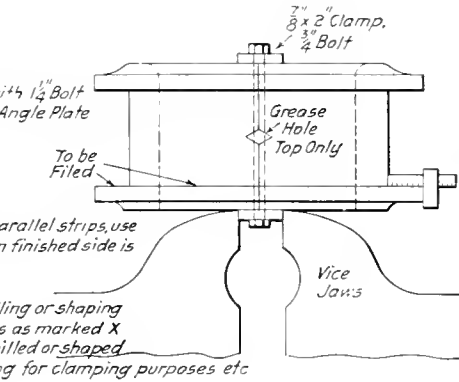

Fig. 5—Holding Brasses in Vise for Filing

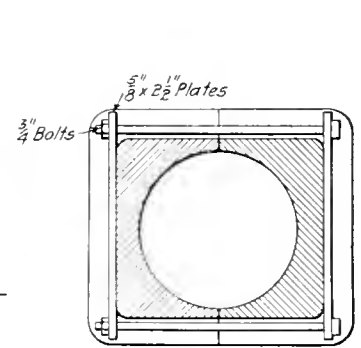

Fig. 6—Clamp for Holding Brasses for Boring

finished, is located near the press, so the bushings may be pressed in after they have been turned. The rods are then laid on four 8-in. blocks near the press for boring. The rod boring machine is also located nearby. After the bushings have been bored in the side rods they are placed on trestles to have the grease grooves cut and grease cups fitted, and to be made ready for the engine. Near the small lathe, two or four trestles are located on which the side rods having jaws, are to be placed so the lathe man can fit the knuckle pins. Any reaming necessary prior to this, of course, can be done on the rod boring machine. The small grinder shown in the machine tool layout is operated by each

bench-man who in any but very large shops, should grind his own pins for the set of rods on which he is working. No grindstone or emery wheel is shown as it will be understood that such will be found in any shop. If the rod work can be situated where it can be under the travel of an overhead crane, so much the better. A cast iron V-block should be placed near the lathes for inserting mandrels in the large bushings.

While local conditions will govern to some extent the arrangement of tools for the rod work the above shows a logical layout that will expedite the work.

REPAIRING MAIN RODS

After the main rods have been removed from the locomotives they should be completely dismantled and cleaned in the lye vat or with oil and waste. Both the rods and the brasses should be carefully examined for cracks. The good back end brasses should be babbitted if there is too much clearance between them and the jaws of the rod, being chipped and filed to make a good fit. The old brasses that are to be used again should each be closed 1/16 in. for reboring. Unless the front end brasses have been renewed recently, they should be renewed if the engine is getting general repairs.

Fitting New Back End Brasses.—The new back end brasses are taken from stock with the two halves which have had their joining sides trued up on a shaper, sweated together. The sides are then faced in a shaper or milling machine to within 1/8 in. or 3/16 in. of their standard thickness. They are next machined to fit the rods. Where a number of brasses for rods of the same type are to be machined the work can be done quicker on a milling machine, several brasses being done at one time. Care must be taken in setting them up so that they will have the proper alignment. Where but few new brasses of one size are required it would not pay to have a milling machine for fitting new brasses, as too many cutters of various widths would be required, besides the trouble in preparing machine, etc. A shaper would, under these circumstances, be better suited for this work. Fig. 4

shows how the brass is clamped to the angle plate on a shaper. After the one side is finished the brass is given a quarter turn and the second side is cut, it being squared with the finished side. Two parallel strips are placed under the finished surfaces for squaring the brass for finishing the other two surfaces.

After being shaped the brasses are filed on the flanges to fit the rod. As the two halves are still attached to each other, a clamp is bolted to them and they are held in a vise as shown in Fig. 5. After the filing is done the clamp is removed and the corners of the front half of the brasses are rounded to fit the rod. The brasses are then broken

apart and stenciled right or left and the engine number is stamped on the outside side of the brass. They are then bored in the lathe, the clamp shown in Fig. 6 being used for holding the two halves together. A pair of parallel strips is placed between the brasses and face plate of the lathe and a pipe center in tail stock is run up against the brasses holding them in place until they are clamped. They are also faced to the proper thickness on this machine.

The rod man then fits the brasses on the pin and files the top and bottom of the bore, where halves meet, for clearance, so they will not pinch when bolts are tightened. A V is cut in each half at the top for the grease to pass

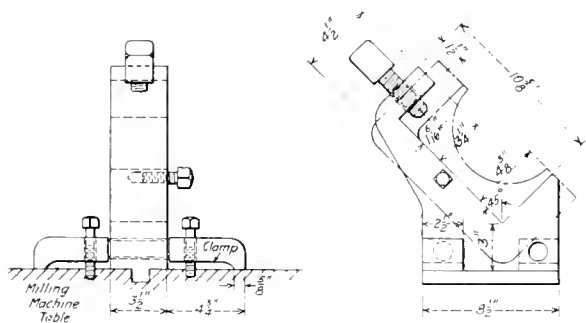

Fig. 7—Jig for Holding the Brass for Milling the Grease Grooves

through to the pin from the grease cup. The inside corners directly above the brass are also chipped away to within 1/4 in. of each side of the brass to permit the grease to spread out over the pin. Two grooves for retaining the grease are milled with a special round nosed end mill toward the corners, as that is the thickest part. Fig. 7 shows the jig for holding the brass while this is being done. After filing off any burrs, the back end brasses are ready for application to the rods.

Fitting New Front End Brasses.—The new front end brasses are held in stock with the two halves sweated together in a manner similar to the back end brasses. They are machined on the shaper before being placed in stock. When they are to be used they are laid out and the corners rounded, roughly on an emery wheel. They are then filed to a fit. The back half is fitted first, as it has two small flanges which fit over the wedge block. Fig 8 shows a jig for boring the brasses. It is clamped to the face plate of lathe, parallel strips being used to provide a clearance for cutting tool. The brasses are inserted and held in position by the two set screws and wedge.

Any size of brasses can be bored with this jig, and they can be set up without removing the jig from its position. The one key has a lip on it to prevent it from dropping from the jig. A V is cut in each half and about 3/32 in. is chipped from each adjoining edge so that as they wear they can be keyed up without striking each other. A cupped washer is used on the front end key to provide a clearance for the body of the key as it is drawn in as the brasses wear. This cup also serves to hold the thin liners placed between the key and the block, the tapered end being bent over and under the cup. It is recommended, however, that all front end liners be riveted to the key as otherwise they may get lost and cause trouble.

The striking points of the piston should be taken and marked on the guide. The travel of the crosshead is made to come within these points by the adjustment of liners in either the back or front end brasses of the main rod.

MAKING NEW MAIN RODS

It is easier and cheaper to make new main rods two or more at a time. The sides of both the front and back ends are planed or milled. They are then laid out, drilled,

slotted and the long central part milled and fluted. After the sides of the front and back ends are milled the rods can be laid out while on the same milling machine and the body milled and fluted before they are removed from this machine. This will save handling. The rod then goes to the drill press, where holes in the corners of the opening for the front end brasses are drilled at both the front and back ends. The rods are then taken to a slotter and slotted out two at a time. After the back end is slotted out, two holes are drilled both at the top and bottom, and cut out for the wedge bolt and wedge. The large back end blocks can be made cheaper by planing up long slabs, planing the keyway in them and then sawing them off to the proper length on a cold cut saw or a slotter.

The front end main rod key blocks can also be started in a similar manner and after being cut off, they are finished in pairs on the shaper.

Set screws with a thin head for clearance, are required for both the front and back ends. They should be turned down at the end so that they may be removed easily and they should be hardened.

The next operation is turning the oil cup and drilling the oil hole on the front end and the grease cup at the back end. A hollow end mill is used for this work. The back end grease cup is tapped out and the screw plunger with a nut for tightening is applied. Two stiff brass wires 3/32 in. in diameter are inserted and riveted into the cup at the front end. Under these a small quantity of hair is tightly inserted to hold the oil and prevent dirt working into the bearing.

The wedges should be milled on both sides for the set screws, so they can be used on the right or left side of the

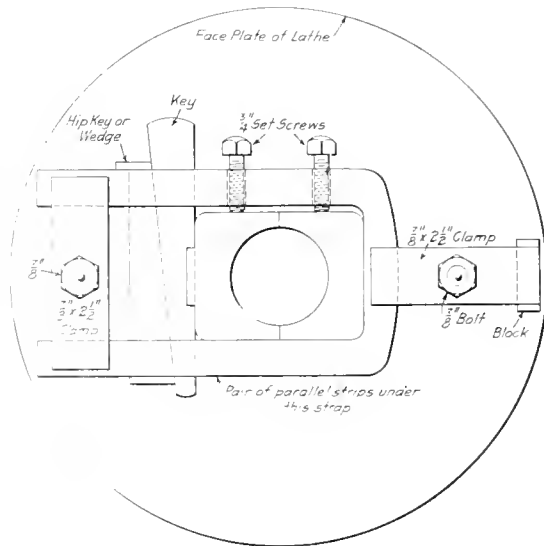

Fig. 8—Jig for Holding the Front End Main Brass for Boring

engine. They can be milled by setting up two at one time with the tapered faces together. This will bring the surface to be milled parallel with the bed of the machine. This also applies to the front end keys which should be milled on both sides for set screws so they can be used right or left. The half round side of the back end wedge bolts and front end keys is machined by means of a radius attachment on a shaper.

REPAIRING SIDE RODS

The plugs and bushings are removed from the side rods as soon as they are removed from the locomotive and the side rods are cleaned and inspected. Those parts of the

rods at which the cracks are most likely to occur are examined with a magnifying glass. The bushed holes are examined for roundness and if worn too much out of round they are re bored, or if they have been re bored to the limit a new end is welded on.

The jaws and stub ends, which become more or less worn, are filed true. The rods are connected up for alignment test and any resetting is done in the smith shop. The jaws are reamed for the knuckle joint pins and the holes for the knuckle joint bushings are trued up by re boring if necessary. New knuckle joint pins and bushings which are kept in stock ready to be fitted, are finished for the rods and casehardened over night. The bronze bushings which are kept in stock, rough bored with one side faced and the bore rounded for the crank pin fillet, are then put on an expanding mandrel and faced to the proper thickness and turned to fit the rod, one side being slightly relieved to start it in the rod.

The bushings are then pressed in the rods with an air press, white lead or oil being used on the bushing. Before pressing any bushings in, especially brass bushings, any burrs that are in the hole should be filed off as they will cut the bushing so it will become loose in a short time. The knuckle joint pins are ground to properly fit the steel bushings. The rods are then laid on some small blocks and connected to each other, the knuckle joint pins being driven in tight. Short pieces of wood are inserted in the pin holes on which the center of the holes are located. The rods are then trammed for length. If none of the centers are over $\frac{1}{8}$ in. out, scribe a circle on the bushing accordingly and center punch it for locating central when boring. If they are over $\frac{1}{8}$ in. out of center, scribe a circle from

the right side should be put on first and then the left can be put on.

The helper should look out for the crank and knuckle pin washers, nuts and taper pins. The mechanic in charge of the job should see that there is a scant 1 to in. side play and he should also screw down the grease cups until grea-

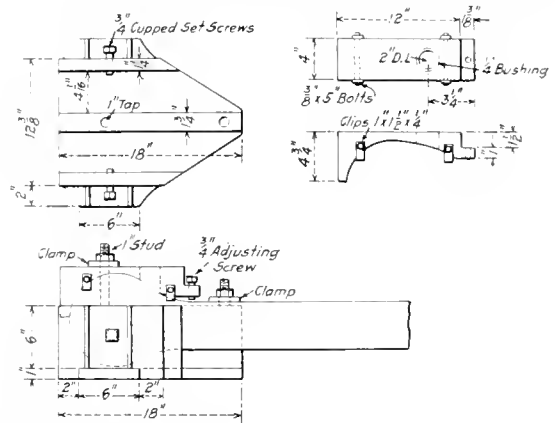

Fig. 10—Jig for Drilling the Knuckle Pin Connection for Slotting

comes out somewhere from around the pin and then refill the cups.

MAKING NEW SIDE RODS

The side rods should be made in multiples of two as they can be made cheaper in this way. They are handled in a manner similar to that of the main rod. After being milled on the flats and laid out and the edges milled, the ends are finished on the slotter, two or four being handled at one time. The crank pin holes are then bored out. Fig. 9 shows a tool for doing this work. It is made in one piece. The part that holds the tool is 2 in. by 2 1/4 in. The tools are 7, 10 in. or 1/2 in. thick and are held in place by two set screws. The shank is made to fit spindle of boring machine. A one inch hole is drilled entirely through the rod for the pilot pin. This pin enters the work for about 1/2 in. before the tools start to cut. The cut is carried through half way and the rod is turned over to finish the cut. After the metal has been removed a light finishing cut is taken with a boring tool.

The knuckle pin ends of the rods are then finished on the flats. The grease cups are handled in a manner similar to that described under new main rods. The slot in the ends of the side rod for the knuckle pin connection is made with the aid of the jig shown in Fig. 10. This is used for drilling the jaw prior to slotting. This jig consists of a casting with a 1 3/4 in. wall in the middle and a 1 1/4 in. wall on the sides with openings 4 1-16 in. wide. The rods are placed on each side of the middle wall, being held against it by 3/4-in. set screws through the outer walls. A steel drill-guide shaped to fit the rod is placed on top of each rod and is held in position by a clamp as shown, an adjusting screw at the right of the guide being set to properly locate the hole. The hole in the guide through which the drill passes is provided with a hardened steel bushing. Clips are provided on the drill guide to center it on the rod. After being drilled, the jaw is cut out on the slotter, two cuts being necessary. A tool 7 16 in. or 1/2 in. wide is used for this work and after the metal has been removed a tool of standard width is used for finishing. After this jaw is slotted the hole for the knuckle pin is drilled and reamed and dowel pin hole cut in. The pressing in of the bushings, fitting knuckle pins, etc., is the same as described under "Repairs to Side Rods."

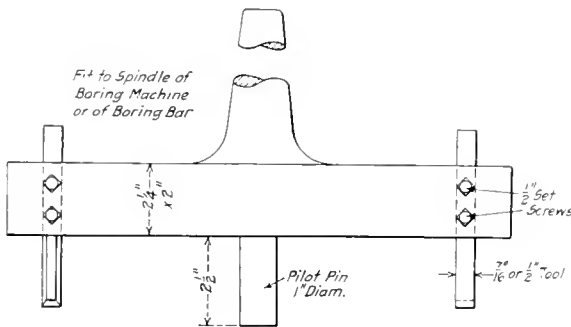

Fig. 9—Tool for Boring Side Rods

the true center of the bushing, center punch it and have the rod lengthened or shortened as the case may require.

The bushings are bored on a two spindle rod boring machine. While one is being bored the operator can be getting the other started. It is this man's duty to caliper the pins and bore the bushings accordingly. Almost any good sized vertical drill press can be fitted up for doing this work, but in a large shop the two spindle rod boring machine would pay for itself by increasing the output.

The oil and grease grooves are then chipped and all burrs are removed. The fillet of the bushing is then carefully filed. The plugs which hold the bushings in place are screwed in and the grease cups are fitted and their operation inspected. The rods are then taken to the locomotive and applied. Generally the left crank pin is one-quarter turn ahead of the right, in which case it is placed on top quarter which would make the right side on the back center. It would be practically impossible to get the rods on the right side if the left ones were put on first, as to move a pin 1/8 in. forward or back on the right side would cause possibly a 1/2 in. movement of the pin of that wheel on the left side and that would throw that side too far out. In this case

MILLING MACHINES IN RAILROAD SHOPS

Classes of Work for Which They are Fitted. Cutters of Proper Design is an Important Consideration

BY HARVEY DE WITT WOLCOMB

THE great variety of work done in a railroad machine shop demands an equipment that will not only be adapted to turn out jobs economically, but also to handle many different forms of work on one machine.

It has been proven that it is really a saving in some instances to make castings with plenty of stock so as to be finished for different shapes of work, thus putting it up to the machine department to remove the surplus stock both quickly and economically. One large manufacturing concern has discontinued the careful making of patterns for iron castings, and simply casts a rough piece somewhere near the required shape so that the machine department can produce a finished piece. With the use of the planer or shaper, this surplus stock means more cuts, which in turn means added time for finishing, but with the milling machine the amount of finish has very little bearing on the time taken to turn out a job.

In locomotive repair work, such as machining side and main rods, guides, or other parts which require a neat finish, it was the policy to plane and then draw file, but this has been eliminated by having the work done on the milling machine which gives a neat and accurate finish. Comparing the time taken to do the work, it has been found that the milling machine does a job much quicker and leaves the work perfectly smooth so that no hand work is required to remove rough edges. Panelling side rods is one of the jobs in which the milling machine has been questioned as to its true economy. Some roads claim it is more economical to recess the rod at each end and then plane out the stock in the center on a standard planer; however, when all things are considered, such as time to re-set, handle from one machine to the other, cost and upkeep of machine tools, it will be found that the milling machine is by far the better machine.

In describing the range of jobs that can be successfully handled on the milling machine, it may safely be said that it will "do everything but talk." While the milling machine is used more for removing material on straight pieces, or where curves are required, there are many jobs now handled on a lathe that could be done to better advantage on a milling machine. In automobile construction it has been demonstrated that it is more economical to revolve a piece of work once, having the material removed by a revolving milling cutter, than to have the same job handled in a lathe where there is only one cutting tool. Criticism of the theory of the milling machine may be more or less a matter of opinion, but based on actual results and backed up by the evidence of actual production, there can be no doubt as to what this type of machine will do.

Such jobs as machining crosshead gibs, shoes and wedges and other plain pieces of work, can be done to good advantage on the slab miller. A recent job assigned to this type of machine is the re-planing of guides, for in this case it has been found that the milling machine will machine the bearing side and both edges at one operation, and when completed will leave a finish far better than can be given with a planer.

The vertical miller is of course used for machining side rod ends, motion work hangers and other parts, and may be used to a good advantage to handle heavy jobs that are now done on a drill press. One job in particular is the milling of the dry pipe flue sheet joint on the front flue sheet, a job which has, as a rule, been handled on a boring mill

or large drill press. To do this job on the vertical miller, it is first necessary to cut the joint to about the required shape with a regular boring tool and then finish with a large form cutter, sometimes called a "sun flower" reamer.

Such jobs as milling keyways in piston rods, rods, and valve rods has for some time been handled on the milling machine and has proved to be quicker and less expensive than the old method of chipping out by hand after being drilled.

CASEHARDENED CUTTERS RECOMMENDED

The making of and upkeep of milling tools is the one question where there can be any argument as to the economy effected with the use of this type of machine. Some shops claim that it is more economical to make high speed steel cutters, while others use the inserted tooth construction, and still others use a soft grade of steel and caseharden the tool. Of the three methods, the inserted tooth cutter and the soft steel case-hardened tools are by far the better and give excellent service. Under the present conditions when it is imperative to conserve every piece of high speed tool steel, there should be no solid high speed tool steel cutters made, for even if the tool room mechanics are experts, many times a costly tool will last only a short time.

In making bolt cutter dies, it has been found that the high speed tool steel cutter is not a success, for it is almost impossible to get a perfect temper at the cutting edges, and this same argument holds good with solid milling machine cutters. As milling cutters wear rapidly, they should be made of as soft material as possible so as to be machined quickly in quantities and at a low cost; by using a soft material it becomes necessary to harden in some other manner than by drawing the temper. The best results for tools of this kind are obtained by the casehardening process which gives a hard tool and one that can be reground a few times before it becomes necessary to anneal and re-cut.

Many operators make the mistake of trying to operate the cutters at too fast a speed. A casehardened tool is very hard but will not stand high heat, and good results can be obtained by decreasing the speed and increasing the amount of feed. Every tool room has a pet theory as to the best manner of making tools and the kind of material that should enter into their construction but if the forces in charge of the tool room will experiment with casehardened tools made from scrap locomotive tires, they will find that it is possible to get splendid results.

One of the past serious drawbacks to the claims of the milling machine has been the cost of tools. It may be found that the tool room force is making tools at too great a cost to show economy in the operation of the milling machine. If such conditions are gone into thoroughly and ideas are developed to turn out cheaply tools that will stand up, the true worth of this machine will be proven. One trouble has been that the tool room foreman has been making tools from the tool room viewpoint, i. e., with no regard to the cost in comparison to the amount of work that will be performed. The average tool room force will object to the casehardened tool on account of the attention it requires, but when the cost is figured up in comparison with the amount of work turned out, it will be found that this type of tool is very successful.

There are many good standard types of inserted tooth milling cutters but no matter where you go, you will find the

tool room foreman trying to get up or re-design a milling cutter. Rather than to experiment thus, it is suggested that a certain type of cutter be adopted and made standard and then the tool room force exert its energies towards decreasing the cost of manufacture. The type of tool and the service rendered enter very much into the cost factors of turning out work on a milling machine; therefore this one item cannot be given too much attention.

The last point in favor of the milling machine is the claim of its accuracy, for milling tools can be set to gages so that the finished jobs will have exactly the same dimensions. For instance, if shoes and wedges are machined on a planer, the operator may make them a little full or a little scant of the desired sizes but with the milling machine with the inserted tooth cutters which are all ground to the same gage the work can be more accurately finished. Under the present conditions of rushing work through the shop, the machine hand does not always use care in taking his final cut so that jobs do not fit perfectly; with the milling machine, however, every job can be alike. As an example of this, a certain machine builder mills a hexagon fitted handle shaft so close that the handle easily slides on the shaft yet the vibrations of the machine will not jar the handle off. Try this job on a shaper or planer and see how easy it is!

While there are some jobs that cannot be handled to advantage on the milling machine, it is a fact that if a shop equipment was made up of the same number of milling machines as there are planers and shapers, the shop would be able to show a very largely increased output. Shop conditions will of course determine to some extent what tool is best suited for the local work, but with a battery of millers there will be very few jobs that cannot be handled to good advantage.

WELDING A CRACKED CYLINDER

BY JOSEPH SCHNEEBERGER

A Mikado type locomotive with 28-in. cylinders recently came into the shops with a crack through the steam port at the front end of the cylinder. The crack extended about half way around the barrel of the cylinder over the top. This was first repaired by chipping out the crack about 5/16 in. and filling it with copper, well hammered in. The cylinder was tested cold and showed no evidences of leaking, but when the engine was fired up and placed in service, the crack opened up again. To have patched this cylinder would have cost at least \$250 and the following method of repairing the cylinder without the use of a patch was resorted to. The work did not cost over five dollars and did not hold the engine out of service.

A row of 13 5/32-in. holes, two inches apart, was drilled on each side of the crack and tapped out with 1/2-in. standard threads. Machine bolts 1/2 in. in diameter fitting snugly in the holes were screwed in tight and the projecting ends burned off with oxy-acetylene at a point 1/4 in. above the surface of the cylinder casting. These projecting ends were then polished with a file and emery cloth. A strip of metal was then built up with the electric welder across the crack from the end of each bolt to the end of the opposite bolt in the other row. Longitudinal bands of metal were thus built up at intervals of two inches, the shrinkage as the welding proceeded, tightly drawing the casting together against the copper, which still remained in the crack. When the welding was completed it was found that the shrinkage had slightly warped the cylinder head joint. This was faced off with a boring bar and the engine placed in service. It has now been running for some time without any evidence of a leak.

At the present time several cylinders are being repaired by this method. One was cracked all the way down the back from the smoke arch to the exhaust port. This job has been completed and no evidence of any leak can be seen.

GAGES FOR DETERMINING THE LIFT OF AIR PUMP INLET AND DISCHARGE VALVES

BY H. S. WALDRON

The set of gages shown in the drawings is very useful to the air pump repair man in determining the lift of the air inlet and discharge valves of locomotive air pumps.

Fig. 1 shows the gages which are used at the lower valves. With the valve cage removed from the pump and the valve in place, the height of the valve from the face of the cylinder casting is determined by placing the legs of the valve gage upon the shoulder under the head of the cage and then run-

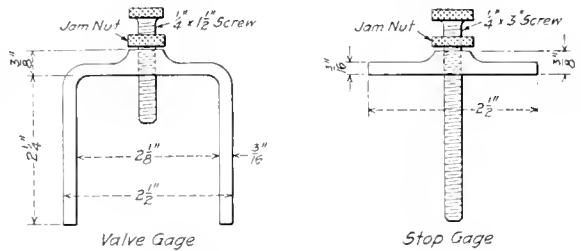

Fig. 1—Gages for Determining the Lift of Lower Inlet and Discharge Valves

ning the adjusting screw down until it touches the top of the valve. The height of the valve stop from the face of the cylinder casting is then obtained by placing the body of the stop gage across the cage opening in the cylinder and running out the adjusting screw until the end touches the stop. With the two gages set together, the distance between the ends of the two adjusting screws will exactly equal the lift of the valve. If a new valve is to be applied the valve gage should be set to the stop gage, allowance being made for the desired amount of lift, and the valve ground off until the legs of the valve gage just touch the shoulder under the head of the cage when the valve is on its seat.

In Fig. 2 are shown the gages for the upper valves. In this case the valve gage is set by placing the body across the opening in the air cylinder casting and running out the ad-

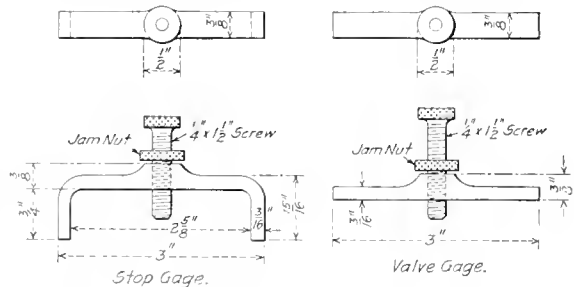
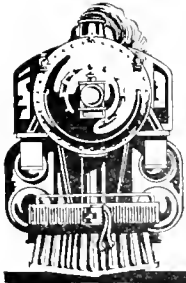
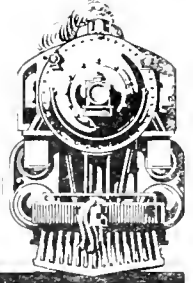

Fig. 2—Gages for Determining the Lift of the Upper Valves

justing screw until the end just touches the top of the valve, the latter being in place on its seat. The height of the stop is obtained by placing the legs of the stop gage against the shoulder under the head of the valve cap, the adjusting screw being set to touch the face of the stop on the inside of the cap. By placing the two gages together the lift of the valve is plainly indicated by the distance between the ends of the adjusting screws. In fitting new valves to provide the desired lift, the valve gage is set to the stop gage, allowance being made for the lift of the valve. The valve is then ground off until the body of the gage rests upon the face of the cylinder casting with the end of the adjusting screw just touching the top of the valve.



LOCOMOTIVES



LOCOMOTIVE FEED WATER HEATING*

How the Wasted Heat from Locomotives May Be Utilized in Preheating the Feed Water Economically

THE purpose of this report is to point out the benefits to be derived from the employment of preheat, to make known its source and the avenues of approach to the desired end, with illustrations of recent developments and practical results. As superheating is the final stage prior to the distribution of the product of the boiler, so is the preheating of feed water the initial stage closely approaching, if not equal to, the effective value of superheat, yet detracting in no wise from it. Preheat is now perhaps the one fundamental source of economy practically untouched in American locomotive practice, yet universally employed as an essential for stationary and marine boiler operation.

The economy, expressed in percentage of fuel saving, to be derived from preheated as compared to non-preheated feed water is in direct ratio as the temperature difference of the water before and after heating is to the difference between the total heat of the saturated steam at a given pressure and the final temperature of the preheated feed water. This may be expressed in the formula

$$S = \frac{100 (t-t_1)}{H + 32 - t_1}$$

S = The percentage of saving from preheat.
t = The temperature in degrees F. after preheating.
t₁ = The temperature of the feed water before heating.
H = The total B. t. u. above 32° F. of saturated steam at the given pressure.

To obtain the maximum theoretical saving from preheating, the water must be brought up to the temperature of the saturated steam. With *t* less than the temperature of the saturated steam, and both *t* and *t*₁ constant, the percentage of saving varies inversely with the boiler pressure, increasing as the temperature difference between steam and water decreases. Hence it follows that with other conditions remaining constant, the higher the initial temperature, the greater is the percentage of economy per degree rise of preheat. The theoretical fuel saving from preheating is shown in Fig. 1.

PREHEAT AS RELATING TO LOCOMOTIVE OPERATION

From an operating standpoint, feed water heating is a pre-requisite to the best performance and maximum locomotive efficiency. The introduction of comparatively cold water into the locomotive boiler reduces the effectiveness of the entire machine appreciably, especially on heavy grades, where almost invariably a drop in pressure results, often at a crucial moment when every pound the boiler can produce is needed. The utilization of preheat permits a freer steaming boiler, confidence is instilled into the fireman and a better "job of firing" is obtained, with consequent increase in locomotive capacity.

*An abstract of a committee report of the International Railway Fuel Association presented at its 1917 convention.

It is evident that the earnings of a railroad are vitally affected by the efficiency of the motive power unit in reducing the cost of operating expenses and increasing the net operating revenues. Fig. 2 illustrates graphically the saving in dollars per annum per locomotive, at different rates of fuel consumption and varied cost of fuel per ton on engine tanks, in the use of preheated feed water.

BOILER MAINTENANCE

One of the most favorable aspects of preheating is its effect upon boiler maintenance, although it would be difficult to establish any definite relation existing between higher feed water temperatures and the decreased cost of maintaining boilers. The effect of preheating is to lessen the difference between the temperature of feed water injected and the temperature of saturated steam evaporated. A more uniform temperature throughout the boiler, resulting from feed water heating, will effect a greater reduction in strains upon the boiler than a considerable reduction in boiler pressure.

HEAT BALANCE

That a clear understanding of the principles underlying the construction and operation of feed water heaters may be had, it is advisable to review, in some degree, the subject of heat and its source and distribution in a steam locomotive.

The unit for measuring heat is a British thermal unit (B. t. u.). A B. t. u. is defined as 1-180 of the amount of heat required to raise the temperature of one pound of pure water from 32 deg. to 212 deg. F.

A pound of locomotive coal usually contains between 10,000 and 14,000 B. t. u. The distribution of this heat after it is liberated from the coal varies widely under different conditions. There is, consequently, a broad range of proportions of heat distribution from which to select an example for discussion.

Choosing one which will fairly represent attainable everyday practice on a properly proportioned locomotive of fairly large size and equipped with a superheater and brick arch, we find that 14,000 B. t. u. in each pound of coal could be distributed about as follows:

Lost to ash pan in unconsumed coal and heat in ashes.....	280 B. t. u.
Absorbed by firebox heating surface.....	3,750 B. t. u.
Absorbed through boiler tubes.....	5,810 B. t. u.
Total to water.....	9,590 B. t. u.
Absorbed by steam in superheating.....	1,050 B. t. u.
Total in steam.....	10,640 B. t. u.
Lost out of stack in hot gases, cinders, water vapor from moisture in coal and in incomplete combustion of gases.....	3,080 B. t. u.
Total.....	14,000 B. t. u.

It is seen that 10,640 B. t. u. or 76 per cent of the total goes into the steam. This is the boiler efficiency. It will

vary from less than 40 per cent to as high as 80 per cent in a reasonably clean boiler. Within the range of ordinary locomotive operation higher efficiencies accompany the lower rates of coal consumption per hour.

Investigating the distribution of this heat further, it will be found that the B. t. u. in the steam may be split up as follows:

To the drawbar to pull trains.....	980 B. t. u.
Used in friction of the locomotive.....	140 B. t. u.
Radiated from the whole locomotive (this includes radiation from the fuel bed).....	420 B. t. u.
Used by the air pump (assumed).....	840 B. t. u.
Discharged up the stack in the exhaust steam.....	8,260 B. t. u.
	10,640 B. t. u.

From these two tables it will be seen that 11,310 B. t. u. of the 14,000 B. t. u. in the coal, or 81 per cent, may go up the stack in form of hot gases, cinders, etc., and in the exhaust steam.

SOURCES OF PREHEAT

From the foregoing it is readily seen that the source of preheat is exhaust steam and waste gases, the potential energy of which must be utilized, at least in part, for preheating if useful work is to be obtained therefrom.

Exhaust Steam.—In exhaust steam there seems to be the greatest waste. Most of it, however, is unavoidable, a large part of the exhaust being essential to produce the draft required for rapid rate of combustion in the firebox.

Consider first what happens when heat is applied to water. For example, take a boiler under a pressure of 200

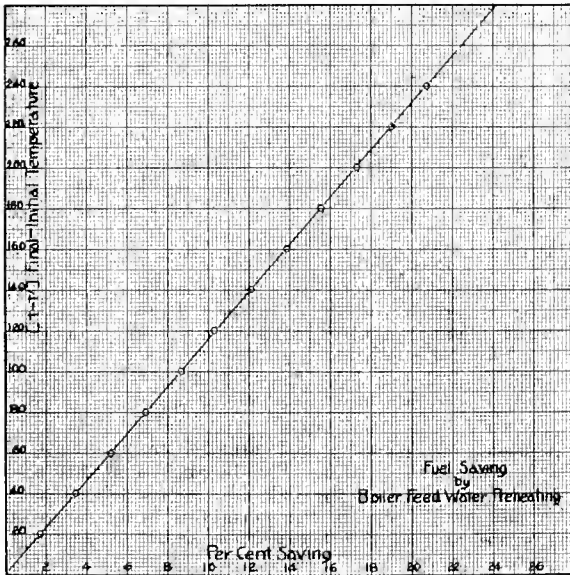

Fig. 1—Percentage of Fuel Saving by Feed Water Heating

lb., and feed water at 60 deg. temperature. The first effect is to raise the temperature of the water from 60 deg. to 388 deg., which is the boiling point of water under 200 lb. pressure. For a pound of water this will require, roughly, 388—60 or 328 B. t. u. (accurately, 333.4 B. t. u.). It is now at the boiling point, but none of it has actually been changed into steam. Continue the addition of heat, and it will gradually evaporate into steam, and when 837.9 B. t. u. have been added the original pound of water is all steam, but still remains at 388 deg. temperature. The heat that has been added without changing the temperature is called the "latent heat," and is really transformed in the work of the physical change in the structure from a liquid to a gas.

If the heat is continued after all the water is evaporated,

the thermometer will again show the effect and the steam becomes superheated. The addition of approximately 111 B. t. u. will raise the temperature of the steam from 388 deg. to 588 deg., or a superheat of 200 deg. F.

For a pound of superheated steam under 200 pounds pressure and at a temperature of 588 deg. there is required about 1,282 B. t. u. if the feed water is 60 deg. temperature. Of this 837.9 B. t. u., or over 65 per cent, is the latent heat and simply keeps it in the form of steam. Therefore if steam is to be exhausted and not water from the cylinders all of this latent heat must be discharged, as well as the heat it took to raise the temperature of the water from 60 deg. to the boiling point at the exhaust pressure, amounting to over 88 per cent of the heat that goes to the cylinder.

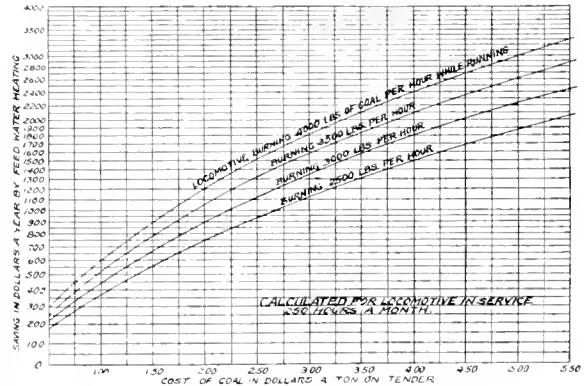

Fig. 2—Amount of Money to Be Saved Yearly by Feed Water Heating

There must necessarily be some back pressure, and the higher it is the greater will be this percentage.

This latent heat, however, will all be given up if the steam is condensed back into water, and it is from this source that an exhaust steam feed water heater makes its saving. Thus with 60 deg. feed water and 10 lb. back pressure it is possible to use but about 16 per cent of the exhaust for feed water heating. The remainder must still be wasted until some hitherto untried method is conceived to use it.

Experiments have shown that the abstracting of 16 per cent of the exhaust does not in most cases require a reduction in the size of the nozzle to get the same vacuum in the front end and the same draft of the fire.

Table I gives in more detail the distribution of the heat in a normal locomotive. The first column gives the distribution where no feed water heater is used and the second column shows the distribution where an exhaust steam feed water heater is used. The coal is assumed to have a heat value of 13,808 B. t. u. per lb. of coal.

Fig. 3 illustrates graphically the effect of applying an exhaust feed water heater to a locomotive. It will be noted that the figures showing the B. t. u.s and percentages are the same as shown in the second column of Table I. The feed water heater is assumed to be abstracting 14 per cent of the heat in the exhaust steam. In both cases the same locomotive is considered and exactly the same amount of steam at the same pressure and superheat is supplied to the cylinders, and the same quantity of heat is used for work at the draw bar; likewise the same amount is discharged from the cylinders; yet on the locomotive equipped with the pre-heater only 60 lb. of coal per square foot of grate area is consumed as compared to 70 lb. where no heater is used, supplying 60,000,000 B. t. u. from the coal instead of 69,041,000, a net saving of about 15 per cent.

It will be noted in this table that some changes have been

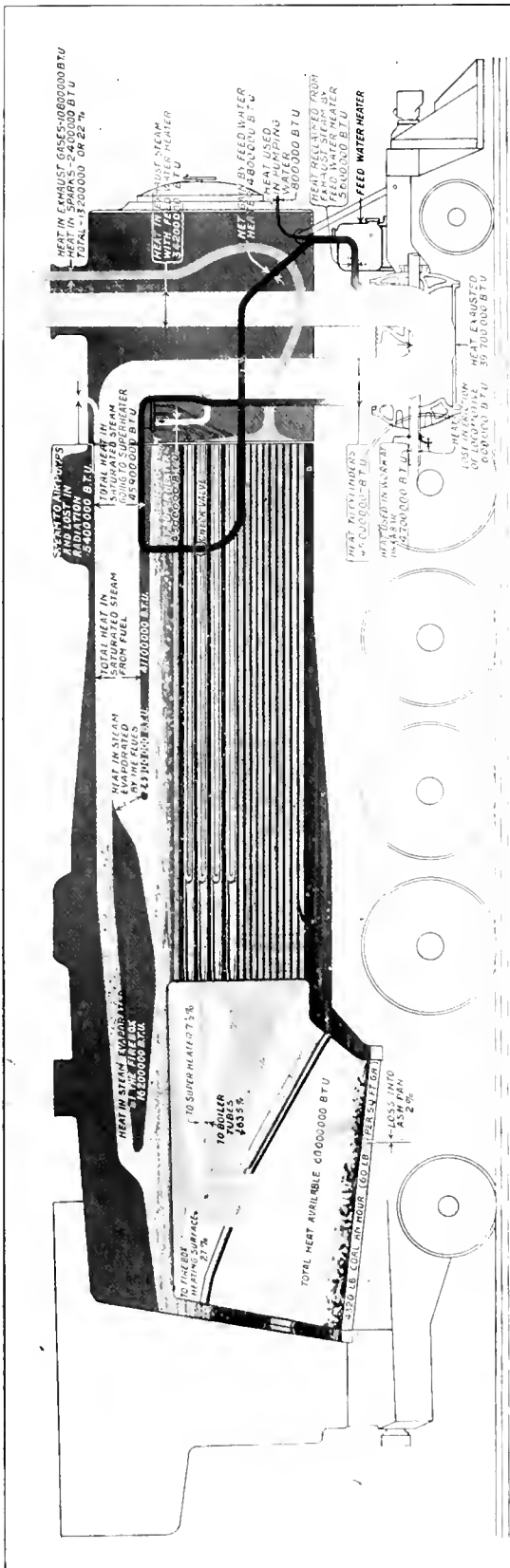

Fig. 3 Graphic Representation of the Distribution of Heat in a Locomotive Equipped with an Exhaust Steam Feed Water Heater

made in the proportions of the heat going to different points as shown in the second column, and that the proportion of the total heat in the coal that reappears as heat in the steam is different. This is true in actual practice, as has been shown many times by tests. It simply is an illustration of the fact that the lower rates of combustion on the grate are accompanied by a higher boiler efficiency, which condition has been mentioned previously.

It will be noted in Fig. 3 that a part of the heat coming from the feed water heater is shown as being wasted, and marked as the heat required for pumping. In this case it is considered that the steam going to the feed pump is exhausted to the atmosphere and lost. Actually, however, the exhaust from the feed pump is generally carried into the exhaust steam heater and condensed, a part of its heat being recovered.

Smoke Box Gases.—Irrespective of the use we may put exhaust steam to, we must still contend with smoke box waste. When the great volume of hot gas passing through the front

TABLE I.

Feed water Heater?	No	Yes
Rate of firing (lb. per hr.)	5,000	4,320
Coal fired per sq. ft. of grate area (lb.)	70	60
Total heat available (B. t. u.)	69,041,000	60,000,000
Percentage of total heat to boiler tubes	27	27
Percentage of total heat to boiler heating surface	64.5	63.5
Percentage of total heat lost to ash pan	2	2
Percentage of total heat to superheater	6.5	7.5
Heat in steam evaporated by firebox (B. t. u.)	18,641,000	16,200,000
Heat in steam evaporated by tubes (B. t. u.)	27,259,000	24,900,000
Heat in saturated steam going to superheater (B. t. u.)	45,900,000	45,900,000
Heat in steam lost through radiation and air pumps (B. t. u.)	5,400,000	5,400,000
Heat added to steam by superheater (B. t. u.)	4,500,000	4,500,000
Heat in steam fed to cylinders (B. t. u.)	45,000,000	45,000,000
Heat used in work at draw bar (B. t. u.)	4,700,000	4,700,000
Heat lost in friction of locomotive (B. t. u.)	600,000	600,000
Heat in steam exhausted from cylinder (B. t. u.)	39,700,000	39,700,000
Heat in steam exhausted from stack (B. t. u.)	39,700,000	34,200,000
Heat reclaimed from cylinder exhaust by feed water heater (B. t. u.)		5,600,000
Heat used to operate feed pump (B. t. u.)		800,000
Heat lost in sparks and gases (B. t. u.)	17,260,000	13,200,000

end of a locomotive is considered, the possibilities of preheat from this source are apparent.

In ordinary practice the front end temperature is approximately 600 or 700 deg. F., while the temperature of the water in the boiler at 200 lb. pressure is 388 deg., and when the engine is working, the weight of heated gases may average two and a half to three times that of the water evaporated.

The heat transfer rate from hot gas to water is lower than that from exhaust steam to water per square foot of heating surface, likewise the heat per pound of gas is less than that of the exhaust, hence much greater heating surface is required per degree rise in temperature in a gas heater than in an exhaust heater. It is impracticable to design either a smoke box or exhaust heater to preheat water from the tank to boiler temperature, but ample space is afforded in the front end of the modern locomotive, in addition to the space required for superheater units, to build a gas heater of sufficient heating surface to obtain a high degree of preheat, feeding by means of the injector, the preheat increasing with the velocity and temperature of the gases.

As the final temperature of the feed water from the exhaust heater is limited to a point below that of the temperature of the exhaust steam, the smoke box heater presents greater possibilities when injector feeding is practiced, particularly when certain types of injectors are used which deliver the water at a higher temperature than that of the exhaust steam, from and above which point the smoke box heater may carry on the heating process up to the limits of the heat transfer rate for that particular design of heater and conditions of operation.

After utilizing all of the exhaust steam possible in preheating, there is still a margin of 140 deg. to 180 deg. between the feed temperature and that of the water in the boiler; and to bring these temperatures closer together we

Copyrighted by the Locomotive Feed Water Heater Co.

have only the waste gases to fall back upon, hence with initial temperatures lower than that of the exhaust steam the advisability of using exhaust steam and smoke box heater in connection is clearly evident.

The practical limit of preheating feed water by means of smoke box gases is that of the boiling point, which at 200 lb. pressure is 388 deg. F. If a front end heater is used independently and not in combination with an exhaust steam heater, assuming an initial feed water temperature of 160 deg., the feed water offers the possibility of absorbing 228 B. t. u. per pound. If we assume an evaporation of 7 lb. of water per pound of coal, there will be offered an opportunity of absorbing, roughly, 1,596 B. t. u. per pound of coal, or approximately 50 per cent of the heat of the gases passing out through the stack. This requires a greater heating surface than is obtainable in the ordinary smoke box, due to space limitations. It is apparent that the higher the

supplementary unit conforming to the baffle and table plate, which are not removed. This unit consists of two headers connected by means of curved tubes, so arranged and connected as to allow a circulation of water through the supplementary header *D* into tubes *G*, into header *E*, thence into the boiler. This modification increases the heating surface and permits accessibility and easy cleaning of all parts. In some respects this arrangement is similar to that developed by F. F. Gaines, superintendent of motive power, Central of Georgia Railway. Smoke box heaters of this type are being constructed for test by the committee, both for road service and in the railway testing plant of the University of Illinois, the results of which tests among others will be available for publication in a subsequent report.

Auxiliary Heater—Type B.—An exhaust steam preheater is contemplated as an auxiliary unit in connection with the front end heater, as in a former series of heater tests,* this

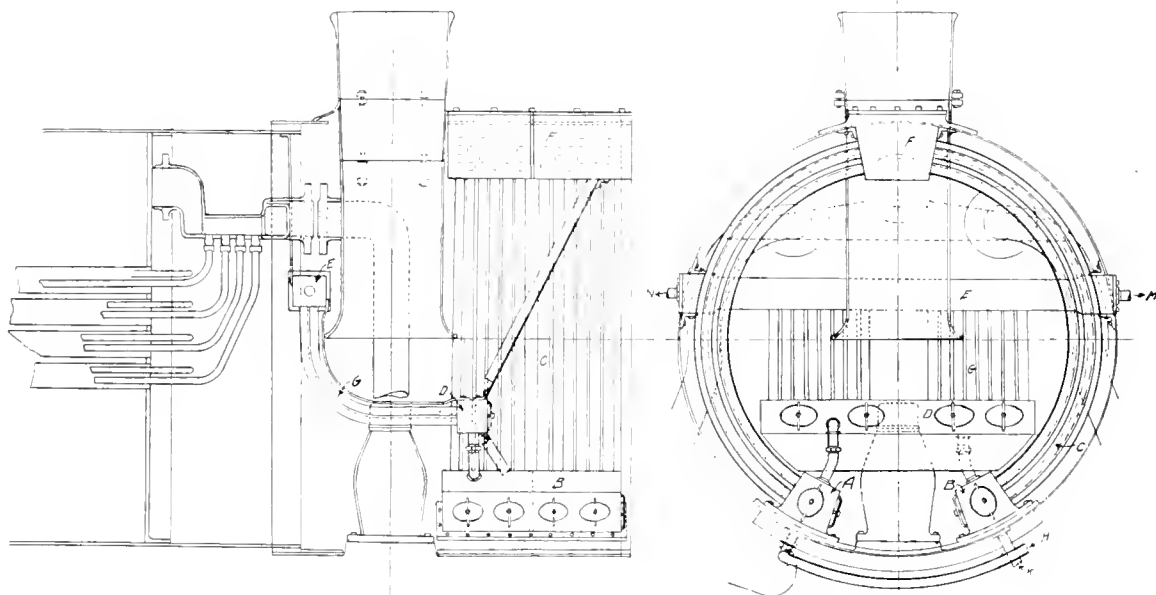

A, B, D, E and F are cast steel headers.
C and G are 2-in. steel tubes headed and welded to the headers.

H and K connect with the branch pipe from the left injector.
M and N connect with the boiler check

Fig. 4—Smoke Box Feed Water Heater

percentage of the available B. t. u. in the gases absorbed by the preheater, the greater is the efficiency.

TYPES OF LOCOMOTIVE FEED WATER HEATERS

Locomotive feed water heaters may be classified in three types, with varied design and structural detail which will not be dwelt upon in this report. These types are as follows:

- (a) Waste gas type.
- (b) Exhaust steam or surface condenser type.
- (c) Exhaust or open heater type.

Smoke Box Heaters—Type A.—A smoke box gas heater was developed for the purpose of experiment by this Association in connection with the discussion of this subject at the 1914 meeting.* It is essentially a water line smoke box and diaphragm. A modification of this type heater is being developed as shown in Fig. 4, the shell and flat plates of the diaphragm being supplanted by a series or system of tubes terminating in the manifold headers contained within the smoke box, providing a continuous circuit from header to header in a circumferential direction around the inside of the smoke box. This section of the heater is connected to a

unit being illustrated in Fig. 5, and is designed for application to the boiler feed line between the injector or pump and the smoke box heater, placed under the running board on either side or both. The water to be heated is introduced into compartment 2 of header *A*. Exhaust steam from the exhaust passages of the cylinder and from the air or feed pump is admitted at openings 3 and 4, passing around the tubes.

Exhaust Steam Heater—Type B.—Of Type B one of the most efficient exhaust steam heaters is illustrated in Fig. 6. This is an independent unit, fed by a pump of special design. This construction is known as a spirally corrugated film type heater. It consists of two spirally corrugated copper tubes, one placed within the other, so as to leave a space 3/16-in. wide between the two tubes. The water to be heated passes between the tubes in the form of a thin film, and the exhaust steam that is being condensed reaches the outer surface of the outer tube and the inner surface of the inner tube, thus placing the film between the two heating surfaces. A new type of heater is being developed along these lines by the same engineers, which will permit the condensing of the same quantity of steam with less frictional resistance through the heater.

* Paper by Munro P. Lanier—1914 Proceedings.

Open Heaters—Type C.—Open heaters with direct condensation of the steam into the water is probably the first development of the system of preheating. Direct condensation may be handled in two ways: First by an exhaust steam injector, which not only acts as a heater but also pumps the water; and second, by injection of the steam into the water in a heater, and then pumping it into the boiler. The most common practice is to discharge the exhaust from the pump into the tank, where a maximum temperature of 104 deg. F. may be limited by a thermostatic valve.

AGITATION AND CONVECTION

Velocity of water flow is a material factor in preheating. Very extensive experiments that have been made with different forms of apparatus have proved that the heat transfer through a metal tube from steam to water varies with the

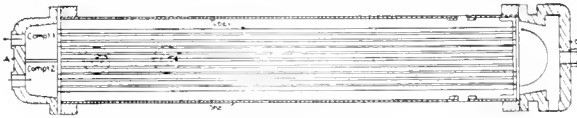

Fig. 5—Exhaust Steam Heater—Type B

amount of agitation of the water within the tube, particularly the scouring action of the water against the tube. In other words, there seems to be no difficulty in getting the heat through the metal, and the problem is to get it into the water. The faster each particle of water is brought into close contact with the tube and taken away again to give room for the next particle, the faster will be the heat transfer through each unit area of the tube.

HEAT TRANSFER

The heat transfer rate from smoke box gases to water seems to follow the same general laws as govern the transfer from the gases in boiler tubes to water.

AXIOMS OF PREHEATER CONSTRUCTION

Six principles for feed water heating of all types, most of which have been confirmed by separate boards of engi-

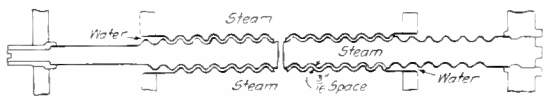

Fig. 6—A Unit of An Exhaust Steam Heater

neers in France and England, cover the essential features very closely. These are as follows:

1. The apparatus should present simplicity of construction and facilitate examination, cleaning and overhauling.
2. The heater should take up as little room as possible, and be of a minimum weight.
3. It should give continuous and certain supply of hot water.
4. Feed water should be heated by steam or gas, otherwise lost.
5. The steam used for heating should vary with the quantity of water required by the boiler.
6. Smoke box heaters should be placed within the path of the hot gases, presenting the smallest gas passage section practicable without detriment to draft.

BOILER FEEDING

It is advisable beyond question to use a water pump in connection with exhaust steam water heaters for the following reasons, assuming that a satisfactory pump may be developed for the rough usage of locomotive practice: It has been clearly shown that the amount of waste heat that can be abstracted from the exhaust is dependent entirely upon the

range over which the water can be heated. The upper point of this range is fixed by the temperature of the exhaust steam, which naturally cannot be exceeded, and therefore the inlet temperature should be as low as possible in order to get the widest range of temperature change and reclaim the largest amount of waste heat that is feasible. The inlet temperature cannot be below the temperature of the water in the tank, but it should not be above this. Therefore it is undesirable to raise the temperature by live steam, as would be the case if an injector were used before it enters the heater. For instance, take the case mentioned above, where the injector raised the temperature of the feed water over 100 deg. by means of live steam—this would simply mean the impossibility of abstracting over 100 B. t. u. from the exhaust steam for each pound of feed water which could otherwise be reclaimed. With hot gas preheaters this does not apply, as the heat available from this source may be absorbed in addition to that heat supplied through the injector.

LOCOMOTIVE FEED WATER PUMPS

There are two kinds of pumps available for this service, one being a modification of the old style cross-head pump, which is simply a water cylinder, the piston of which is operated by direct connection to the running gear of the locomotive. The other is an ordinary steam driven water pump, of which there are a large number on the market.

Westinghouse Vertical Water Pump.—A water pump has been designed especially for locomotive use by the Westinghouse Air Brake Company. A steam cylinder of a 9½-in. air pump is the propelling mechanism. Below this is the water cylinder, which is 6½ in. diameter and is capable of handling up to 88,000 lb. of water an hour. On either side of the water cylinder are large valve chambers, in which the valves are located in removable plates in a very convenient and accessible manner.

This pump is generally supported on the side of the boiler in the same maner as an air pump, and its operation is controlled by a simple type of throttle valve located in the cab. The pump has shown itself to be very efficient and is capable of handling over 50 lb. of water against a pressure of 240 lb. for each pound of steam at a pressure of 165 lb.

There have been several attempts made to heat the water before it goes to the pump. These attempts have been universally unsatisfactory, and it is very important for maximum efficiency and reliable service that the pump handle cold water only.

CONCLUSION

Preheat is a fundamental necessity, easily within our grasp, which can no longer be overlooked. The failure of American railways to utilize preheat is an economic mistake which may be expressed in terms of millions of dollars of lost earnings to them.

The report is signed by: Munro B. Lanier, chairman; Prof. E. C. Schmidt, G. M. Balford, A. B. Appler, L. G. Plant, J. L. Hampson, O. C. Wright, and F. Kerby.

DISCUSSION

There have been numerous trials of feed water heaters extending over a period of many years. Difficulties experienced with the apparatus have always led to its abandonment. The question of maintenance is therefore of extreme importance and in designs which are now being tested this feature has been given special consideration. In exhaust steam heaters the speed at which the water travels gives a high rate of heat transfer by reason of the scouring action and is also effective in keeping the surfaces clean. The introduction of feed water heating gives promise of further increasing the thermal efficiency of the locomotive which has been brought from 3½ to 8 per cent by various improvements in the last two decades.

MIKADO TYPE LOCOMOTIVE TESTS

Pennsylvania Test Plant Results Obtained With Mikado and Consolidation Locomotives Compared

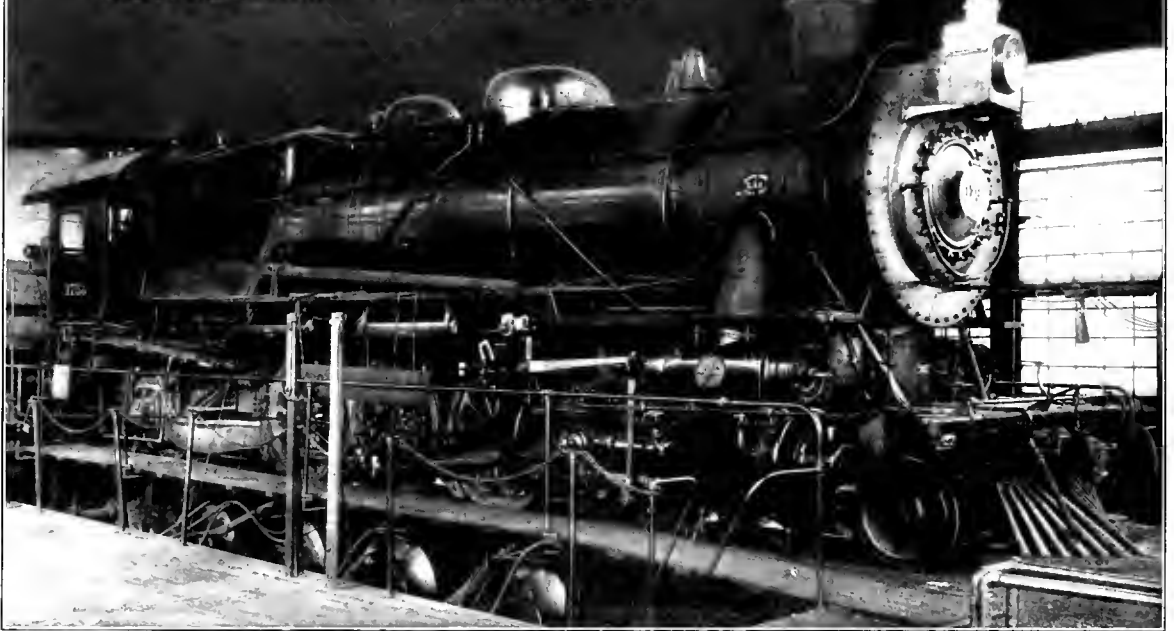

IN a previous article* there were given the results of tests on the testing plant of the Pennsylvania Railroad at Altoona, Pa., of a class Eos Atlantic type locomotive. The present discussion is based on Testing Plant Bulletin No. 28 (copyright, 1915, by the Pennsylvania Railroad Company) which deals with the tests of a class L1s locomotive.

For a long time the Consolidation (2-8-0) type was in general use for freight service on the Pennsylvania; but the requirements of heavier freight trains made greater locomotive capacity desirable, and as larger boiler capacity was essential to obtain this, the Mikado (2-8-2) type was selected. This locomotive was described in the *Railway Mechanical Engineer*, July, 1914, page 343. The same refinement of design is present in this locomotive and in the class K4s Pacific type, as exists in the class Eos Atlantics.

The Consolidation locomotives in general use on the Pennsylvania for the heaviest freight service up to the time that the Mikado type was introduced were the H9s class. The following table gives the principal data for the two classes, and the results obtained in the test of the Mikado are compared throughout with the results of similar tests of one of the Consolidations. Both are simple engines and are equipped with superheaters and brick arches.

Using 80 per cent of the boiler pressure, the calculated maximum tractive effort of the Mikado is 57,850 lb., and the factor of adhesion is 4.08. The calculated drawbar pull is equivalent to 352.7 lb. drawbar pull per lb. of mean effective pressure.

It is worthy of note that with an increase over the Consolidation of 25.7 per cent in total weight, and of 25 per cent in tractive effort (the maximum calculated tractive effort of the Consolidation is 46,300 lb.), there is but 7.2 per cent increase in the weight on drivers, showing that a good weight distribution has been obtained.

The boiler of the Mikado is interchangeable with that of the class K4s Pacific type locomotive, tests of which will be dealt with in a later article. The proportions of the boiler were carefully considered and the firebox portion forms almost one-half the entire length, while the tubes, which are of 2 1/4 in. diameter, are but 19 ft. long, the ratio of length to inside diameter being 114. An internal projection exhaust nozzle, with an area equivalent to a cir-

	Mikado Class L1s	Consolidation Class H9s
Weight in working order, total lb.	320,700	273,050
Weight on drivers, working order, lb.	240,200	228,400
Cylinders, diameter and stroke, in.	27 x 30	27 x 28
Driving wheels, diameter, in.	62	62
Heating surface, tubes (water side), sq. ft.	3,715.7	2,485.2
Heating surface, firebox (including arch tubes), sq. ft.	301.5	189.9
Heating surface, superheater (fire side), sq. ft.	1,171.6	800.0
Heating surface, total (based on water side of tubes), including superheater, sq. ft.	5,188.8	3,279.1
Heating surface, total (based on fire side of tubes), including superheater, sq. ft.	4,847.7	3,279.5
Grate area, sq. ft.	70.0	52.3
Boiler pressure, lb. per sq. inch	205	205
Valves	12 in. piston	12 in. piston
Valve motion	Walschaert	Walschaert
Firebox	Wide, Belpaire	Wide, Belpaire
Tubes, number and outside diameter	237—2 1/4 in.	275—2 in.
Superheater flues, number and outside diameter	40—5 1/2 in.	30—5 1/2 in.
Tubes and flues, length, in.	226.51	81.16

cular nozzle 7 in. in diameter, is used with an inside extension stack 5 ft. 10 in. long, tapering from 24 in. in diameter inside at the top to 17 in. at the point where it bells out at the bottom. The bottom of the stack is 15 1/2 in. above the top of the exhaust nozzle.

The tests were all run with a wide open throttle, the speeds ranging from 7.2 to 31.1 miles an hour, with cut-offs from 20 to 80 per cent of the stroke. The coal used was run of mine, as used in freight service on the Pennsylvania, with a heating value between 13,600 and 14,300 B. T. U. per lb.

**Railway Mechanical Engineer*, April, 1917, page 171.

An analysis of an average sample shows fixed carbon, 58.02 per cent; volatile matter, 31.59 per cent; moisture 1.20 per cent, and ash 9.19 per cent, with sulphur, separately de-

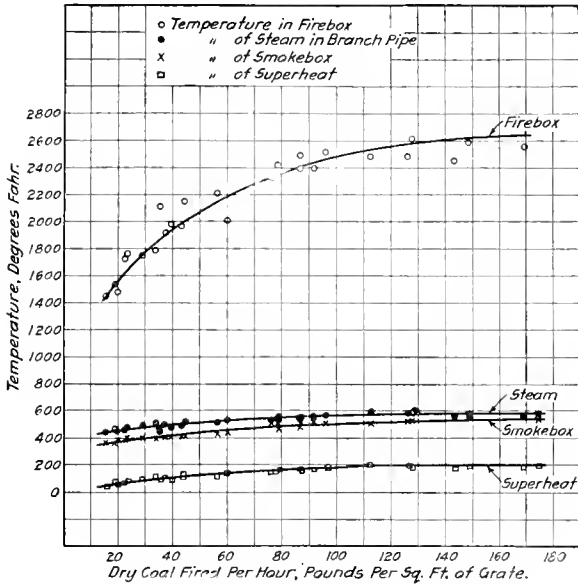

Fig. 1—Steam Temperatures and Temperatures in the Firebox and Smokebox

termined, 1.44 per cent. The B. t. u. per lb. of dry coal are 14,140 and per lb. of combustible 15,590.

BOILER PERFORMANCE

The maximum steam temperature obtained was 590.6 deg., the superheat then being 207 deg. The temperature taken

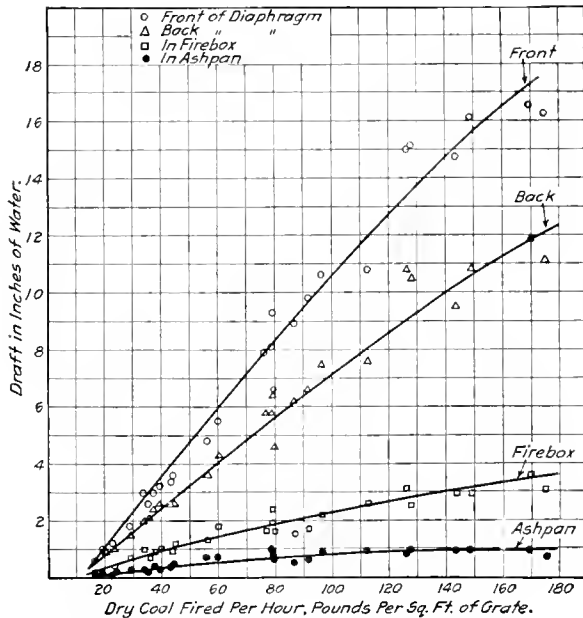

Fig. 2—Draft and Rate of Firing

in the exhaust passage showed superheat in most cases, the maximum being 85.4 deg. The firebox and smokebox temperatures are shown in Fig. 1. It will be noted that, as

a rule, the smokebox temperatures are below 550 deg., indicating the efficiency of the heating surfaces. The firebox temperatures above 2,400 deg., for rates of firing above 85 lb. per sq. ft. of grate per hour, are unusually high and the whole range of firebox temperatures is greater than is usual. Combustion was remarkably good and carbon monoxide in the smokebox gases did not exceed 0.5 per cent under any conditions. These tests showed rates of evaporation never before obtained on the test plant. The draft is shown in Figs. 2 and 3 in relation to the rate of combustion and the evaporation per square foot of heating surface. The ashpan air openings are inadequate, totaling 7.8 sq. ft. which is 11 per cent of the grate area. It has been found that this ratio should not be less than 15 per cent. The draft in the ashpan under maximum firing conditions, about one inch of water, is high.

From comparisons with tests of seven locomotives on the testing plant it is apparent that maximum evaporation is closely related to the fire area or the area of all the tube openings. These seven locomotives indicate that under normal conditions each square foot of fire area of the tubes will

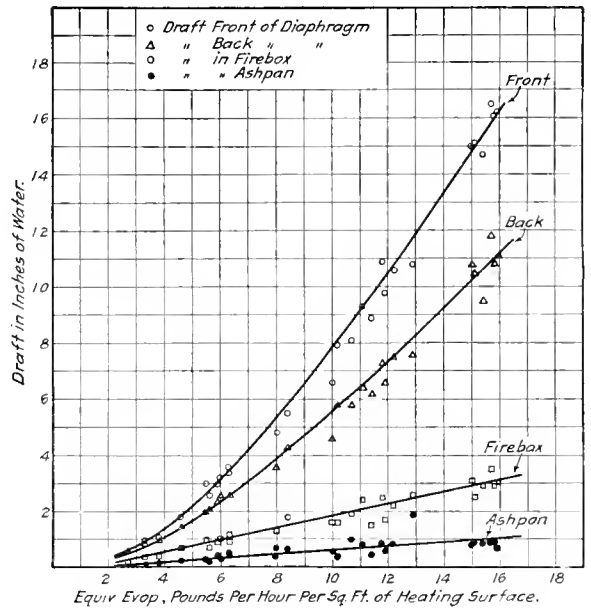

Fig. 3—Relation of Draft to the Rate of Evaporation

give a maximum evaporation of about 7,000 lb. of water per hour. Quoting direct from the bulletin: "Considering further the proportions of these boilers, we have in the following table certain ratios and the maximum evaporation that it was possible to obtain on the test plant:

Class of locomotive	Ratios						Maximum evaporation per hour per square foot of heating surface corresponding rate of combustion, pounds per square foot of grate
	Heating surface to grate	Fire area to grate	Firebox heating surface to grate	Tube heating surface to grate	Firebox volume to grate surface	Firebox evaporation per square foot of grate surface	
D16sb (8-wheel)	47.7	0.12	5.3	6.2	4.6	28.6	197
E3sd, Atlantic	33.5	0.09	3.3	9.2	3.7	34.8	104
K48, Pacific	70.2	0.12	4.4	11.0	6.2	33.3	171
E68, Atlantic	61.2	0.12	4.2	10.2	6.2	33.1	148
L18, Mikado	70.2	0.12	4.4	11.0	6.1	12.8	163
H98-1311, Cons.	64.2	0.13	3.5	13.0	3.6	11.6	132
K28a, Pacific	80.3	0.14	3.9	15.0	4.6	20.9	147
K208, Pacific	77.8	0.13	3.3	17.0	4.4	18.8	120
H98-387, Cons.	63.9	0.13	3.4	13.4	3.6	11.8	93

"The ratio of tube to firebox heating surfaces (column 4) shows a range of values between 6 and 17, and in Fig. 4

this ratio and the maximum evaporation per sq. ft. of total heating surface have been plotted. The H9s-387 has a low maximum evaporation while the evaporation of the H9s-1311, as developed in a second series of tests, shows a normal rate as compared with the other locomotives of this group, all of which have superheaters.

"A maximum evaporation of 38,800 lb. of water per hour was obtained with the improved H9s and this is 11 lb. per sq. ft. of heating surface, or 5,308 lb. per sq. ft. of fire area of tubes. This increased rate of evaporation is still comparatively low, but considering the small firebox heating

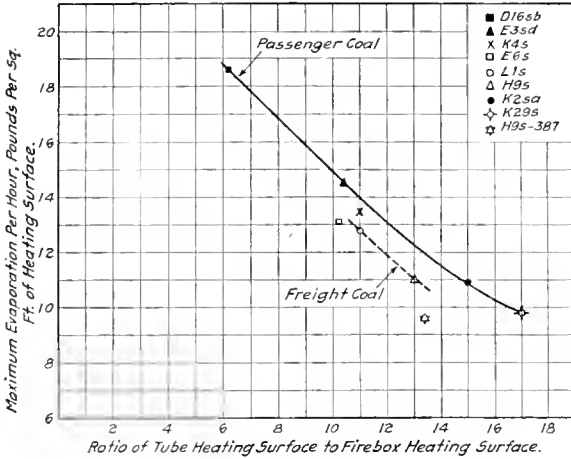

Fig. 4—Rate of Evaporation as Effected by Heating Surface Distribution

surface of the H9s where the ratio of tube heating surface to firebox heating surface is 13, while for the L1s it is 11, or in the L1s the firebox forms a larger proportion of the whole boiler than in the H9s, it is evident that the H9s cannot show as great an evaporation per unit of heating surface as the L1s, and for its firebox heating surface it evaporates about all that may be expected of the design."

It is evident from the exhibits in Fig. 4, that a relatively

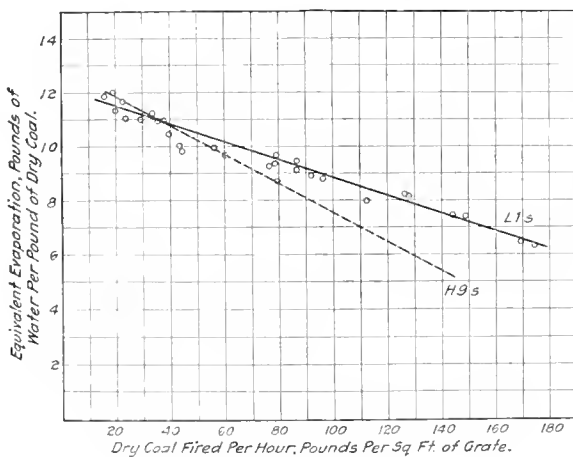

Fig. 5—Relation of Equivalent Evaporation Per Pound of Dry Coal to the Firing Rate

large firebox heating surface makes possible a high rate of evaporation per unit of total heating surface.

The advantage of the larger boiler is evident when comparison is made of the coal fired and water evaporated. The

Consolidation reaches its maximum evaporation at 34,000 lb. per hour, the coal consumption rate being 8,000 lb. per hour; while the Mikado did not reach its evaporative limit till about 60,000 lb. of water were being evaporated per hour, with a coal rate of 12,000 lb.

Equivalent evaporation per lb. of dry coal is shown in

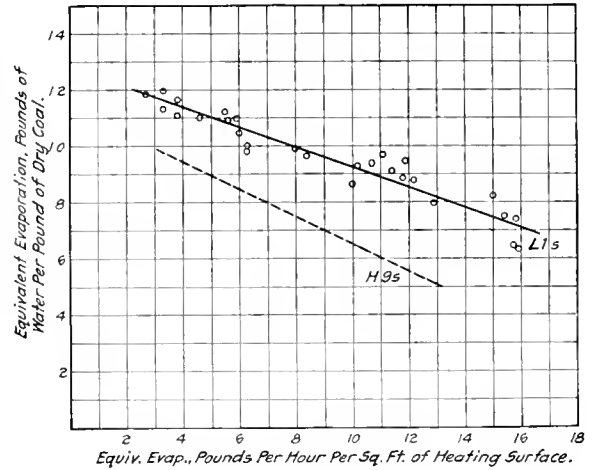

Fig. 6—Equivalent Evaporation Per Pound of Dry Coal in Relation to Rate of Evaporation

Figs. 5 and 6. The results for the Consolidation, it will be seen, are considerably below those for the Mikado, which had a range of firing between 20 and 180 lb. of coal per sq. ft. of grate per hour, and at the highest rate of firing the water evaporated per lb. of coal is above 6 lb. On a basis of heating surface, the Mikado shows a range of evapora-

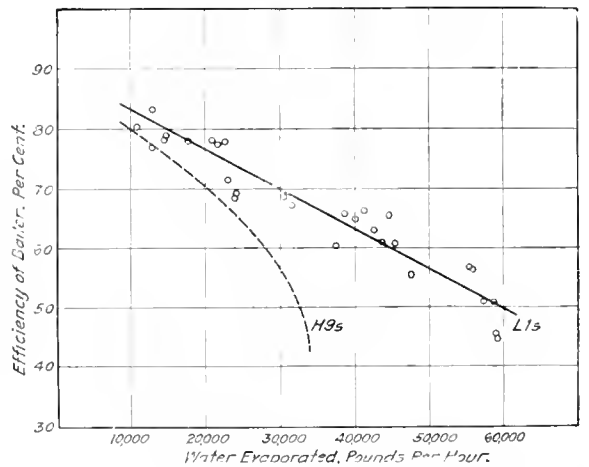

Fig. 7—The Variation of Boiler Efficiency With Evaporation Rate

tion between 3 and 16 lb. of water per sq. ft. of heating surface.

The boiler efficiency is shown by Fig. 7. The boiler horsepower at 3.5 lb. of water per horsepower hour from a feed water temperature of 212 deg. into steam at a temperature of 212 deg., ranged between 382 and 2,332. The efficiency of the boiler was between 80 and 45 per cent. It will be noted from the diagram how rapidly the efficiency of the Consolidation's boiler falls off, compared with that of the Mikado, at rates of evaporation above 25,000 lb. per hour. The Consolidation also showed a lower efficiency at all rates

of firing above 30 lb. per sq. ft. of grate per hour. For the Mikado, the firing rate was between 20 and 175 lb. per sq. ft. of grate, the efficiency of the boiler, as previously stated, ranging between 80 and 45 per cent.

ENGINE PERFORMANCE

The indicated horsepower of the Mikado covered a range between 356 with 20 per cent cut-off at a speed of 7.2 miles

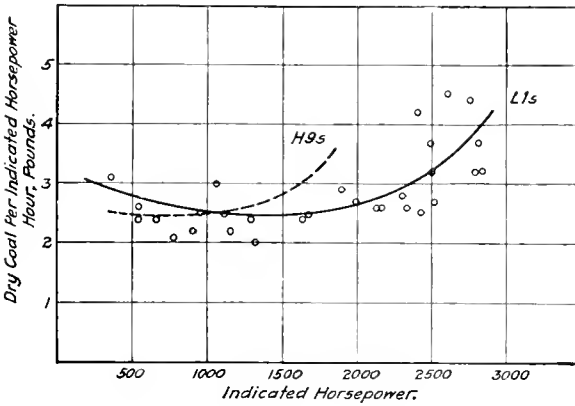

Fig. 8—Coal per Horsepower Hour and Indicated Horsepower

per hour, and 2,837 at 60 per cent cut-off and a speed of 31.1 miles per hour. The coal rate varied between about 2.5 lb. and 4 lb., the greatest economy being at about 1,500 i. hp., where the coal rate is 2.5 lb. per hp. hour. The coal per horsepower is shown in Fig. 8 and the water rate in Fig. 9. The best steam performance of the Mikado is at a rate of working of about 2,000 i. hp. The greater economy of the Consolidation is probably due to the higher degree of superheat obtained. The steam rate of the Mikado varies between 19 lb. and 24 lb. The maximum horsepower obtained from the Mikado, 2,837.2, is greater than that obtained from any other freight locomotive ever tested on this plant, the maxi-

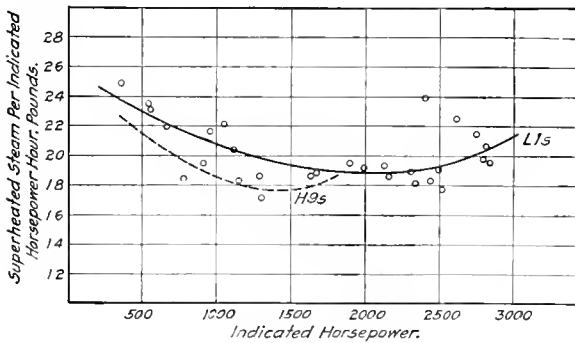

Fig. 9—Water Rate and Indicated Horsepower

imum horsepower of the H9s class having been found to be about 2,100. On the basis of pounds of dry coal fired per hour, the indicated horsepower of the two locomotives is shown in Fig. 10.

In the matter of back pressure, the Mikado shows a minimum of less than one pound and a maximum of 16 lb. At the maximum horsepower of the Consolidation, which was 1,800 in these tests, the back pressure is 8 lb., while the Mikado shows but 4 lb. at the same power. The larger exhaust nozzle of the Mikado, 38.3 sq. in. as against 30.9 sq. in. for the Consolidation, probably has an important bearing on this result.

The Mikado, which has larger cylinders than the Consolidation shows a corresponding increase in horsepower at cut-offs beyond about 40 per cent.

The engines of the Mikado use from 18,500 to 26,100 B. t. u. per i. hp. hour and convert into work from 9.7 to 13.7 per cent of the heat supplied. In plotting the thermal efficiency of the engines it is again found that they are the most efficient when developing about 2,000 i. hp.

DYNAMOMETER RECORD

The dynamometer horsepowers reached are as high as 2,563, the dry coal fired per d. hp. hour ranging between 2.7

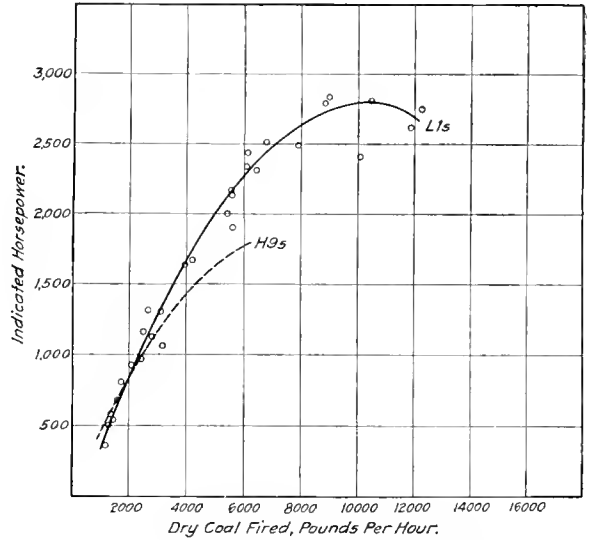

Fig. 10—Relation of Coal Fired to Indicated Horsepower

and 4.8 lb., while the consumption of superheated steam was between 20.1 and 34.6 lb. per d. hp. hour. The thermal efficiency of the locomotive reached 7 per cent. In tests of an hour or more, the drawbar pull ranged between 6,455 lb. at a speed of 170 r. p. m., or 31 miles per hour, with a cut-

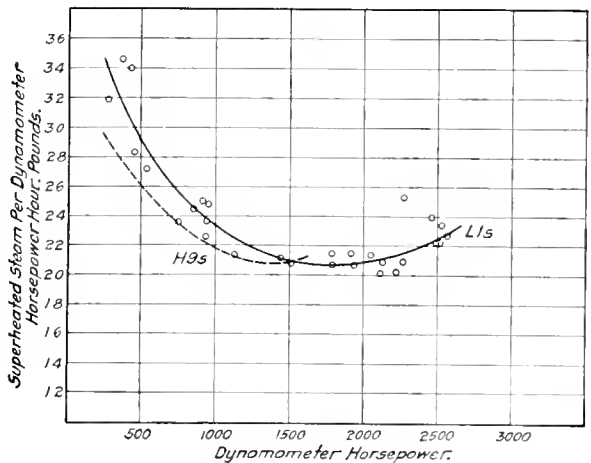

Fig. 11.—Steam Consumption per Dynamometer Horsepower Hour

off of 20 per cent, and 48,962 lb. at 40 r.p.m., or 7.2 m.p.h., and 60 per cent cut-off. Higher pulls were obtained in shorter tests, and the Mikado was shown to be capable of developing a pull of 59,000 lb. up to a speed of 7 m.p.h.,

48,600 lb. at 18 m. p. h. and 32,200 lb. at 30 m. p. h. With the Consolidation, 50,000 lb. was obtained at 7 m.p.h., 33,000 lb. at 18 m. p. h., and 20,000 lb. at 30 m. p. h., showing the advantage of the Mikado over the Consolidation for all classes of freight service.

The steam consumption on the basis of dynamometer horsepower is shown in Fig. 11, while Fig. 12 shows the

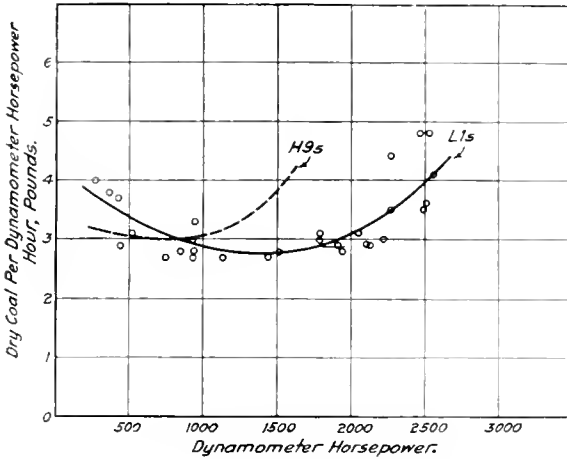

Fig. 12—Coal Consumption per Dynamometer Horsepower Hour

coal consumption. The water rate for the Mikado is comparatively high at horsepowers below 1,500, the best performance being at about 1,800 d. hp. where the steam rate is 20.5 lb. The Mikado shows its best coal performance at about 1,400 d. hp., the rate being 2.75 lb. per hp. hour.

It is possible to operate the Mikado throughout the speed range of the tests at cut-offs between 25 and 60 per cent of

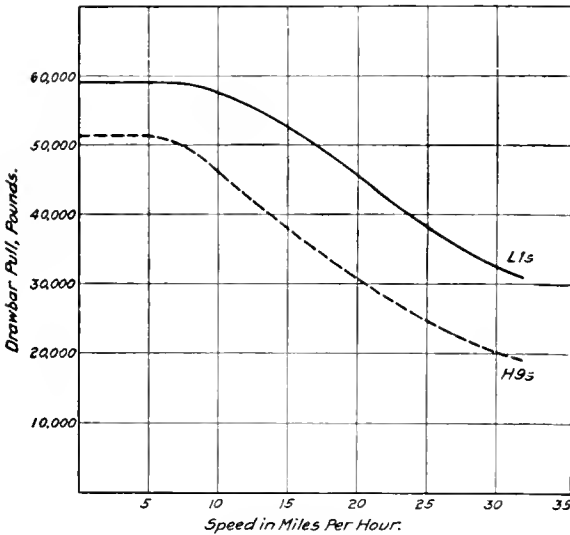

Fig. 13—Drawbar Pull Curves

the stroke, and still not exceed its boiler capacity. On one test, at 18 miles an hour, the boiler furnished steam for a cut-off of 80 per cent. To obtain the highest drawbar pull and at the same time its best efficiency, the locomotive must have a wide open throttle and at speeds below 30 miles an hour the cut-off should be greater than 60 per cent.

The machine efficiency for the Mikado ranged between

64.8 and 94.5 per cent and for the Consolidation between 69.3 and 93.8 per cent. It will be seen that the two locomotives give similar results in this respect, notwithstanding the greater weight on the drivers of the Mikado. The machine efficiency increased up to 18 m.p.h., then decreased as the speed increased to 32 m.p.h. The thermal efficiency showed a tendency to increase with the speed up to 22 m.p.h., after which it gradually fell off. The range was from 3.9 to 7 per cent. The Mikado has some advantage over the Consolidation in thermal efficiency because of its larger boiler.

CONCLUSIONS

The satisfactory performance of the Mikado's boiler is indicated by its maximum evaporation per hour, 6,990 lb. of water per sq. ft. of fire area through the tubes. The design of the smoke stack and front end proved satisfactory, and with the changes in the superheater, the all-around performance of the locomotive was most gratifying, the high horsepower developed being particularly noteworthy. The locomotive was designed to give a capacity about 25 per cent greater than the H9s. The drawbar pulls obtained, however, indicate that it gives 25 per cent greater pulls at 10 m.p.h. and 60 per cent greater at 30 m.p.h. A large number of these locomotives are now in freight service on the Pennsylvania.

KINDLING FIRES IN LOCOMOTIVES*

BY H. B. BROWN
General Fuel Inspector, Illinois Central

In order that a comprehensive idea might be obtained as to the cost of kindling fires in locomotives, a circular letter was sent to the railroads, asking for information regarding the kind of fuel used in kindling fires at terminals, the grate area of the locomotives, the pounds of coal used, the water temperature, the labor cost and total cost. From the replies to this circular, the data shown in the table was compiled. The locomotives were separated into three different classes, one having a large, another a medium and the third a small grate area. In compiling the total cost, 63,000

COMPARATIVE COST OF FIRING UP ENGINES AT TERMINALS.

Material Used for Firing.	Size of Grate Area.	Daily Cost.	Cost for Firing 50 Class Engine		Yearly Savings for Firing Once a Day with Shavings.
			Per Cent Each	Once a Day.	
Dry Shavings.....	Large	\$1.14	\$2,326,968.00
	Medium95	4,847,850.00
	Small68	2,082,024.00
Oil Soaked Shavings.....	Large	2.04	4,164,048.00	\$1,837,080.00
	Medium	1.41	7,195,230.00	2,347,380.00
	Small	1.08	3,306,734.00	1,224,720.00
Scraps, Car Shops.....	Large	\$1.93	\$3,939,516.00	\$5,409,180.00
	Medium	2.08	10,614,240.00	\$1,612,548.00
	Small	1.40	4,286,520.00	5,766,390.00
Cord Wood	Large	\$2.87	\$5,858,244.00	\$2,204,496.00
	Medium	1.19	6,072,570.00	\$9,583,434.00
	Small70	4,286,520.00	\$3,531,276.00
Oil Sprayed on Coal.....	Large	\$1.62	\$3,306,734.00	\$6,960,492.00
	Medium	1.20	6,123,600.00	\$398,034.00
	Small82	2,510,676.00	1,275,750.00
Fuel Oil.....	Large	\$2.35	\$4,796,820.00	\$2,102,436.00
	Medium	1.49	7,603,470.00	\$2,469,852.00
	Small	1.09	3,338,162.00	2,755,620.00
Live Coals.....	Large	\$2.45	\$5,000,940.00	\$6,481,610.00
	Medium	1.40	7,141,680.00	\$2,673,972.00
	Small	1.10	3,367,980.00	2,293,830.00
					\$6,253,758.00

locomotives were considered as being used on 250,000 miles of line, 10 per cent being deducted for the number in shops. The total number of locomotives was divided into the three classes by assuming that 20 per cent of the total have a

* Abstract of a committee report presented at the 1917 Convention of the International Railway Fuel Association.

large grate area, that 50 per cent have a medium grate area and that 30 per cent have a small grate area.

It was found that kindling with dry shavings was the cheapest method and the costs of all the other methods were compared with this method. In the dry shaving method, a one-inch layer of dry shavings was placed on the grate first, then four or five inches of coal and another inch layer of dry shavings. An opening was left in the middle for the full length of the firebox for the admission of air to aid the combustion and to eliminate smoke. The second method of firing shown in the table was similar to the first with the exception that oil soaked shavings were used instead of the

PHILADELPHIA & READING MALLETT LOCOMOTIVES

The Philadelphia & Reading has recently received from the Baldwin Locomotive Works six Mallet locomotives of the 2-8-8-2 type, which develop a tractive effort of 98,400 lb. They are used on the Frackville hill near Pottsville, Pa., which has a ruling grade of 3.3 per cent and curves of 16 deg. The service consists chiefly in hauling empty coal cars up the grade and bringing loads down. They are hauling trains of 38 to 48 cars up the grade with ease, the tonnage being about 45 per cent heavier than that previously handled by the heavy Mikado type locomotives which they have replaced. The Mallet type locomotives are also proving to be easier on the track than were the Mikados.

These locomotives are of special interest because of the restricted clearance limits imposed. The height limit is 15 ft. and the width limit over the low pressure cylinders is 11 ft., while the width over the running boards does not exceed 10 ft. 8 in. The boiler center is placed 9 ft. 9 in. above the rail, and this comparatively low elevation increased the difficulty of working out some of the details of the design.

The boiler is of the Wooten type, which is standard on the Philadelphia & Reading. It is one of the largest Wooten boilers thus far built, having a diameter at the throat of 102 in. and a grate area of 108 sq. ft. It is designed for a pressure of 225 lb., but in service the safety valves are set at 210 lb. The total equivalent heating surface is 7,901 sq. ft. The design incorporates a combustion chamber 40 in. long, across the throat of which is built a brick wall 26 in. high. In flanging the firebox sheets and the back head it was possible to use the same dies which were used for the Mikado type locomotives previously built by the Baldwin Locomotive Works for the same road.

The fire door is single and has a width of 25 in. It is fitted with a Franklin fire door. The grates, which are arranged to shake in five sections, are operated by a Franklin grate shaker. The grate is divided into three sections by two longitudinal bearers. Each side section is operated in three groups; in the center section there are drop plates at the front and back, the bars between the plates being connected in two groups. The ashpan has three hoppers, two of which are placed outside the frames between the rear driving wheels and the trailing truck.

The locomotives are fired by Street type "C" stokers, which are handling a 50 per cent mixture of anthracite buckwheat and bituminous coal very satisfactorily.

The throttle is of the Rushton type, with auxiliary drifting valve. The throttle lever is placed in a vertical position on the right hand side of the cab and is connected to the throttle stem through a transverse rotating shaft. Piston valves 14 in. in diameter control the steam distribution to all the cylinders, and the valve gears are of the Walschaert type. The front and back reverse shafts are supported on the guide bearers and are bent to clear the boiler. A single reach rod, placed on the center line of the locomotive, connects the front and back reverse shafts. This arrangement, which is regularly used on Baldwin Mallet locomotives, occupies but little room and is particularly convenient on an engine where the clearance is restricted as it is in this case.

The high pressure pistons are of box form, while the low pressure pistons have cast steel dished centers with cast iron bull rings bolted on. The bull rings are widened at the bottom to give ample bearing area and no extension rods are used.

The forward frames are stopped just ahead of the leading driving pedestals and are bolted and keyed to a large steel casting which supports the low pressure cylinders. The forward equalizing beam is fulcrumed underneath this casting. The forward equalization system divides between the second and third pairs of driving wheels. As there is no

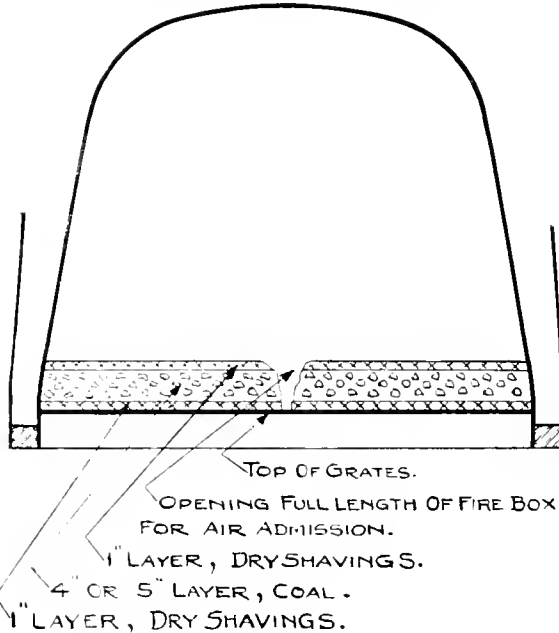

Method of Building Fires with Dry Shavings

dry shavings. The third method refers to a fuel bed made up of a 5-in. layer of scrap wood taken from the car shops, laid directly on top of the grate with a 5-in. layer of coal, an opening being left in the middle of the firebox for the full length for the admission of air. The fourth method relates to the use of a 5-in. layer of cord wood and a 5-in. layer of coal, similar to the third method. The fifth method relates to a 5-in. layer of coal with oil spread on top, an opening being left for the full length of the firebox in the middle of the fuel bed. In kindling fires in locomotives burning fuel oil, the method followed was to use a piece of oil-soaked waste placed on top of the arch. The last method shown in the table relates to the use of live coal for the kindling of the fire.

It was found that a large amount of coal will be saved by placing a layer of shavings on the grate first, as it naturally prevents the coal from falling through the grate bars, becoming ignited in the ash pan and causing its deterioration. The reports show that as high as 80 lb. of coal was lost in this way and where the shavings were placed on top of the grate first, this amount was reduced to six pounds.

DISCUSSION

The cost of kindling fires is not generally realized and the work is seldom done in a systematic manner, due to the employment of cheap labor. Shop scrap and old ties can sometimes be used and are economical and satisfactory. The supply of shavings is often insufficient to meet the requirements. Air jets introduced into the firebox to eliminate smoke have given good results.

room to place springs over the boxes of the first and second pairs of wheels, beams are mounted over these boxes and the frames are supported on inverted leaf springs suspended from the beams. The forward central equalizer is connected to the beams over the front boxes through a transverse semi-elliptic spring, this arrangement having been adopted in lieu of using springs over the front driving boxes.

The radius bar connecting the front and rear frames is attached to a horizontal pin secured to the front frames and has a ball-jointed connection with the hinge pin. This arrangement, which is covered by a patent, has been applied by the builders to a number of recent articulated locomotives. In the Reading engines the frames are not interlocked in any way, so that the articulated joint has maximum flexibility in both a horizontal and vertical direction.

There are four sand boxes, two for the front group of wheels and two for the back group. The boxes are placed right and left on the round of the boiler, and the bell is similarly located on the right hand side. Front bumper steps are provided instead of a pilot, and the equipment in this respect is in accordance with the requirements for switching service.

The detail parts of these locomotives were designed to interchange where practicable with those of the Mikado

Outside diameter of first ring	90 in.
Firebox, length and width	144 1/4 in. by 108 1/2 in.
Firebox plates, thickness	Side, back and crown, 3/8 in.; tube, 5/4 in.
Firebox, water space	Front, 5 in.; sides and back, 4 in.
Tubes, number and outside diameter	277—2 1/4 in.
Flues, number and outside diameter	50—3 1/2 in.
Tubes and flues, length	23 ft.
Heating surface, tubes and flues	5,389 sq. ft.
Heating surface, firebox	358 sq. ft.
Heating surface, total	5,747 sq. ft.
Superheater heating surface	1,436 sq. ft.
Equivalent heating surface*	7,901 sq. ft.
Grate area	108 sq. ft.

Tender

Tank	Water bottom
Wheels, diameter	36 in.
Journals, diameter and length	6 in. by 11 in.
Water capacity	8,000 gal.
Coal capacity	13 tons

* Equivalent heating surface = total evaporative heating surface + 1.5 times the superheating surface.
 † Includes combustion chamber heating surface.

GOOD FIRING

The Baltimore & Ohio, which has for a number of years conducted a strong campaign of education in the matter of firing locomotives, has recently published a text book for its engineers and firemen on good firing. This book contains instructions as to the proper methods of firing, prevention of smoke and the manner in which the various appliances per-

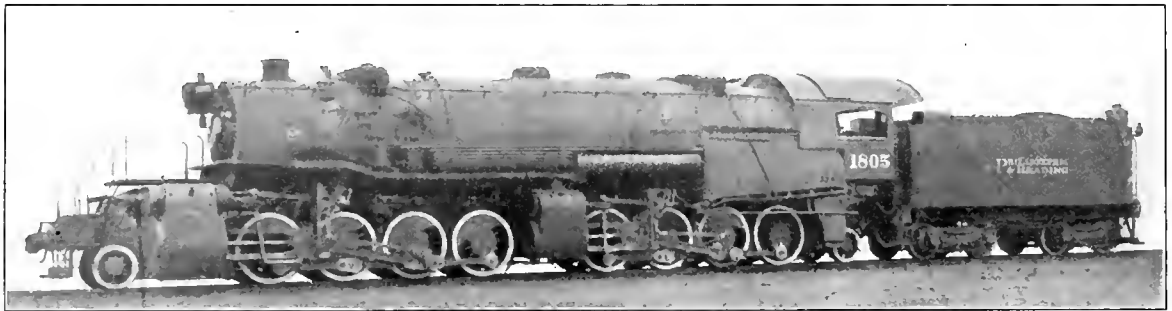

Mallet Type Locomotive for the Philadelphia & Reading

type engines now in service on the Reading. The principal dimensions and ratios are given in the table:

General Data

Gage	4 ft. 8 1/2 in.
Service	Freight
Fuel	Anth. and bit, mixed
Tractive effort	98,400 lb.
Weight in working order	478,500 lb.
Weight on drivers	435,200 lb.
Weight on leading truck	23,600 lb.
Weight on trailing truck	20,300 lb.
Weight of engine and tender in working order (approx.)	630,000 lb.
Wheel base, driving	39 ft. 8 in.
Wheel base, total	55 ft. 10 in.
Wheel base, engine and tender	83 ft. 2 1/2 in.

Ratios

Weight on drivers ÷ tractive effort	4.4
Total weight ÷ tractive effort	4.9
Tractive effort × diam. drivers ÷ equivalent heating surface	691.2
Equivalent heating surface* ÷ grate area	73.2
Firebox heating surface ÷ equivalent heating surface, per cent.	4.5
Weight on drivers ÷ equivalent heating surface*	55.1
Total weight ÷ equivalent heating surface*	60.6
Volume equivalent simple cylinders	27.8 cu. ft.
Equivalent heating surface* ÷ vol. cylinders	284.1
Grate area ÷ vol. cylinders	3.9

Cylinders

Kind	Compound
Diameter and stroke	26 in. and 40 in. by 32 in.

Pistons

Kind	Piston
Diameter	14 in.

Wheels

Driving, diameter over tires	55 1/2 in.
Driving, thickness of tires	3 1/4 in.
Driving journals, main, diameter and length	11 in. by 13 in.
Driving journals, others, diameter and length	11 in. by 13 in.
Engine truck wheels, diameter	33 in.
Engine truck journals	7 in. by 11 in.
Trailing truck wheels, diameter	33 in.
Trailing truck journals	7 in. by 11 in.

Boiler

Style	Wootten, conical
Working pressure	210 lb. per sq. in.

taining to the burning of the fuel should be handled. A brief chapter on the elements in the theory of combustion is also contained in the book and presented in such a manner as to be readily understood by the enginemen. In the back of the book are given sixteen "don'ts" which make for good firing. These are given below:

- Don't slug.
- Don't overload tenders.
- Don't overflow scoops.
- Don't shake grates or use the hook when it may be avoided.
- Don't allow pops to open unnecessarily.
- Don't permit a dirty deck or apron, allowing coal to rattle off.
- Don't knock coal off by careless handling of tools.
- Don't throw large lumps into the fire—crack them.
- Don't use blower, except when necessary.
- Don't permit fire to get too heavy and dirty.
- Don't bring locomotive to terminal with a heavy fire.
- Don't allow fire to die out in front of firebox, causing leaky flues.
- Don't bank fires and leave doors open when descending grades or stopping.
- Don't fire on green coal or any spot unless white.
- Don't permit banks.
- Don't leave firebox open when engine is working hard.

This method of instruction which shows the fireman how he may use his fuel to the best advantage and the reasons why these methods should be followed, is a very good one. With the prospect of 50 per cent to 100 per cent increase in the price of fuel, every means should be taken to interest the engine crew in the economical use of fuel. The time and money taken to write and publish a book of this sort is well invested. Those roads that have not done this should give the matter serious consideration, as nothing should be left undone which will reduce fuel consumption, the cost of which is the largest single item in railroad operating expenses.



THE LUBRICATION OF FREIGHT CARS IN INTERCHANGE*

BY T. J. BURNS

Superintendent Rolling Stock, Michigan Central

The question of hot boxes, their cause, and their cure has been discussed at every railroad club, in the offices of executives, and in the car men's shanty from time immemorial, and we are apparently no nearer a solution of the difficulty than ever,—the hot box in its recurring epidemics is still the bugbear of the profession, so to speak. Are the car men of the country to continue their assaults on the hot box situation along the old line of attack, and rest satisfied that the best has been done that can be done when the mere mechanical processes of the problem have been worked out? Is there no other action to be taken, no policy of lubrication as distinguished from purely mechanical practice which can be introduced that will help us out of the trenches?

I have no intention of discussing methods of packing hot boxes, or in attempting to arrive at any new conclusions as to the best methods of performing the work in a way that leads to greater economy. These points have all been carefully canvassed and we all have our published instructions on lubrication which are undoubtedly quite sufficient. Any further discussion at this time along these particular lines, while no doubt interesting, will get us nowhere in particular.

What I would like to submit, however, is a proposition contemplating that, instead of handling the lubrication of the freight car equipment as it is now handled under the theory that foreign cars will be given the same attention as owned cars, lubrication be put squarely under the M. C. B. Rules of Interchange the same as any other repair. I would propose that Rule 1, the corner stone of the M. C. B. code, be radically changed. I think the time has come when this rule will have to be changed. In its old wording it specified that the receiving line shall provide the same care and attention as to packing and oiling that it gives its own equipment. This was a good theory in its day and in the infancy of car interchange perhaps it served its purpose. But with the tightening up of supervision and the development of lubrication economies some mistaken policies have crept in. I feel I am violating no confidences when I say that it has become a part of the disposition of the receiving line to use only such of its lubricating materials as is absolutely necessary to carry a car over its own rails. I fear we are all more or less tarred with the same stick. Why? Simply because of no compensation either in labor or material for work performed. The result is that the foreign car long off its own rails, running from pillar to post with only such spasmodic oiling as is absolutely necessary at the time, eventually develops a hot box and a new brass is necessary, or perhaps a change of wheels. In our passenger car service where we have the equipment in our own control we repack periodically, but on our freight equipment just because a car is out of our hands we leave it to its fate. Why is it not as necessary to repack freight equipment as

passenger equipment? The freight car journal box and its contained parts, the journal, the waste, and the oil are not of another world, they are of the same physical nature and subject to the same physical laws. Obviously, if we are to expect anywhere near similar performance from the two branches of the service they must receive somewhere near similar treatment. The answer is easy; attend to the packing. The only way this ever will be done will be by inserting in the code a rule that will meet with the necessities of the situation, by putting a premium on the work, and by paying for goods delivered,—just as you have done in your repair schedules by inserting a price that makes it an inducement for a foreign line to help maintain your car and keep it in operation. In other words, institute a system of periodical repacking and reoiling of the freight equipment of the country at large, and by that I mean all the equipment both of railroad and private ownership.

Right here I may as well anticipate the private car owner who will surely rise up in protest. The private car lines who are doing their full duty are not aimed at. If they will do their repacking as they should and guarantee their work by the stencil on their cars, that is all that will be asked of them. The private car owner is surely concerned in the continuous and successful movement of his car equally with the handling line, and one of his cars cut out or delayed enroute is an economic loss in which he has to participate in the final analysis. I only ask that they agree that a fair compensation was due the railroad company that repacked their car and stencilled on the car the necessary data.

All that I have said about the private car owner applies with full force to many of our railroads, and in all fairness to the private car owner we will have to admit that many of them now recognize the importance to themselves of proper lubrication of their equipment, doing work at their own plants that some of the railroads might do well to imitate. There are, however, unfortunately, some private car owners who make no pretense whatever as to the care of journal boxes, and I have this moment distinctly in mind one plant I visited recently where the man in charge took credit unto himself that his expense along this line was nil, and the only oil or waste supply in the entire yard was in a barrel that was used as a receptacle for old packing from destroyed trucks—and here again I may interject that there are some railroads of the same nationality, roads that deliberately "unload" on the receiving lines.

No calling together for educational purposes of our car oilers, no lubrication experts traveling over our line, no posting of blue prints, no instructions to our men, no technical discussions as to journal weights, designs of packing hooks, viscosity of oil, etc., will get us any farther on the high road of broad efficiency in lubrication matters than we now are. If we are looking for further progress in these matters we will have to work away from the idea that unrestricted car movements can be properly cared for by a restricted policy of any kind.

The details of the scheme of periodical reoiling and re-

*A paper read before the Central Railway Club on May 11, 1917.

packing, it is not my purpose to outline in this paper. These matters can be more satisfactorily handled by a competent committee. In general, however, I would suggest that all boxes be repacked say once a year, date of repacking to be suitably stenciled on the body or trucks of the car, a rule covering the matter together with a proper charge and with suitable specifications as to methods to be followed, to be incorporated in the M. C. B. code in its proper place and, as mentioned earlier, the re-vamping of rule No. 1 to correspond.

I fully realize that my position in this matter will be attacked. However, I wish to start a campaign of publicity. I am confident that the day will come when a plan of this kind will go into effect, and it may come much sooner than any of us expect.

In the great transportation scheme of the United States why do we satisfy ourselves with a localized treatment of a problem that effects nation wide commerce? If our railroads were all subject to one general supervision how long would we be allowed, in handling our transcontinental traffic, to work under a lubrication plan that boasts of no system, is intermittent in its application, and inefficient in results? The problems that have to do with car supply, mileage, per diem, even M. C. B. repairs, have all been worked out or are being worked to a point that will measure up to the obligations of the carriers to the traffic of the country, and yet we car men sit supremely satisfied with our local, cramped system of lubrication. If we are unable to see the light ourselves I very much fear it will be pointed out to us.

Definitely and finally, what I have to propose is that the Central Railway Club take this matter under advisement, and whip the matter into shape in time to present it to the authorized committee of the M. C. B. Association for incorporation in its Rules of Interchange at the 1918 Convention.

WOODEN FRAMED FREIGHT EQUIPMENT CARS

BY M. D.

By reason of the present situation in the material market, most of the railroads are confronted both in the purchase of new rolling stock and in the repair and maintenance of existing freight equipment cars, with the problem of not being able to obtain rolled steel shapes, plates or castings in sufficient quantities to justify a suitable shopping program, apart from the fact that the expense involved presents a most serious problem.

Good judgment and a true knowledge of operating conditions must apply in the selection of an economical policy with regard to each separate class of car which is to be considered. In the reinforcement or rebuilding of cars having a rated capacity less than fifty tons, as much serious study is not required as that necessary on equipment of fifty-ton capacity, as in the past the average car of this capacity has not proven to be of equally good design as those having less rated capacity. A detailed study of the heavier equipment shows that in many cases the designers of this equipment have thought it necessary to provide only a truck of larger capacity and leave the body as it was, expecting it to withstand the more severe operating conditions to which it is subjected. This has been a great fault with this equipment and is responsible for a large number of failures with an undue increase in maintenance costs.

Wooden framed box cars having a capacity exceeding 40 tons are not generally considered desirable, because in order to provide reasonable cubical capacity for certain commodities, such as oats and cottonseed, it would give a very much unbalanced structure, the height or length of the car being excessive. Very few designs of wooden 50-ton coal

cars have proven successful in heavy train service. However, it is possible to construct a 50-ton wooden gondola car so as to be reasonably free from failure, but experiments covering a period of several years have demonstrated the following necessary changes in design:

Description.	Original.	Final.
Area of wooden sills	441 sq. in.	425 sq. in.
Truck centers	30 ft.	28 ft.
Overhang	5 ft.	6 ft.
Diameter of truss rods	1 1/4 in.	1 1/4 in.
Number of truss rods	4	4
End sills	8 in. by 15 1/2 in.	8 in. by 15 in. and 15 in., 40-lb. channel
Draft sills	Wooden	Cast steel draft arm or two 8-in. 16 1/4-lb. channels with a top cover plate 20 in. by 1/2 in.
Cubical capacity	1,608	1,200
Truck wheelbase	5 ft. 6 in.	5 ft. 6 in.
Light weight	35,000 lbs.	39,000 lbs.

Most 50-ton steel coal cars have a cubical capacity of 1,700 cu. ft., which gives a rating of 59 lb. per cu. ft. of loading

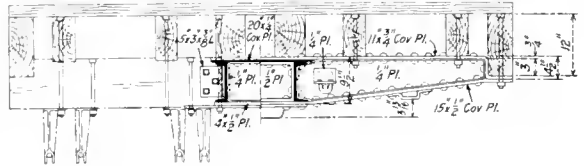

Section of Underframe Showing Final Design for 50-Ton Wooden Coal and Ballast Cars

level full. On the above basis we obtain 1,200 by 59 = 70,800 lb. and twenty per cent for heaping we have 84,960 lb. With clay, gravel, stone, bricks, etc., it is possible to load the equipment to capacity.

If practical operating data is worth anything, it is certainly useful for comparative purposes, and should be used to arrive at definite limits to be followed in practice. In times like these, the mechanical department should conscientiously state the limit to which it may safely go in economizing in design and material. If a wooden coal car of large capacity is to be built, it is admittedly a mistake to allow

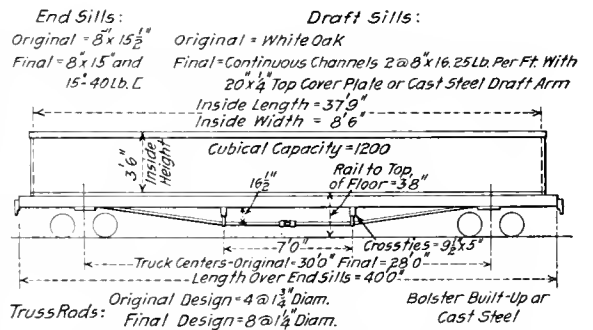
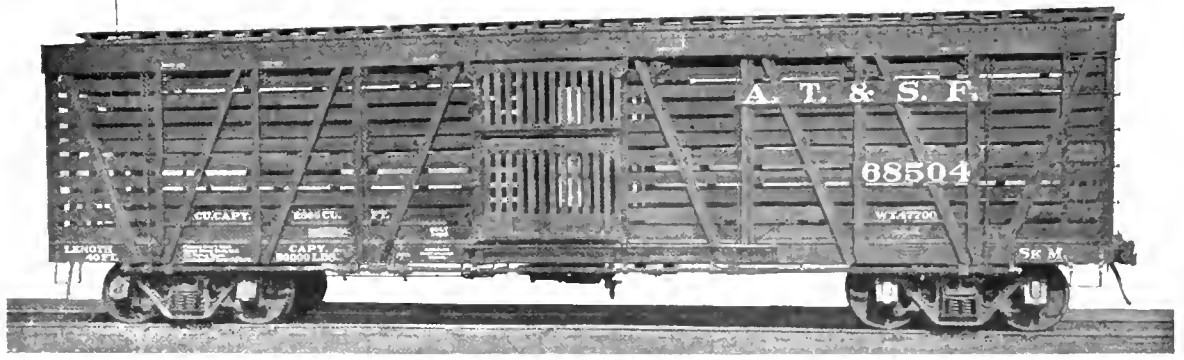

Diagram Showing Outline of Original and Subsequent Design of a Successful Wooden Coal Car, 900 of Which Are Now In Heavy Trunk Line Service

some of the sills to be eliminated and thus weaken the car, to provide for the application of drop doors, for the car will sag at the center and cause the doors to bind, making them ultimately useless.

The purpose of this article is to call attention to the fact that the 50-ton wooden car is a compromise under the existing conditions and when built it must be developed along very definite limits of design. It should not be complicated with mechanisms which are obviously applicable only to equipment constructed partly or entirely of metal when its framing has been developed to work as a unit.



SANTA FE DOUBLE DECK STOCK CARS

Movable Upper Deck in One Section Is Easily Raised;
The Cars Are to Be Used for a Variety of Purposes

THE Santa Fe has had in use for over one year 500 stock cars which are of interest on account of the fact that they include several innovations in stock car construction. The chief feature of the cars is the movable upper deck, which rests on a belt rail, and can be raised by an arrangement of chains and winding shaft when the car is to be used as a single deck car. These cars, which are known in the railroad company's classification as the Class Sk M, are of 80,000 lb. capacity and have a light weight of 47,000 lb. The length inside is 40 ft. and they are 40 ft. 11⁵/₈ in. long over the end sills and 43 ft. 9⁵/₈ in. long over the couplers. The

of the box girder type, the sides being of pressed steel $\frac{1}{4}$ in. thick, spaced 7 in. between the webs. The body bolster cover plates are 14 in. wide, the upper plate being $\frac{1}{2}$ in. and the lower 7 16 in. thick. Under the center of the body bolster is a $\frac{3}{8}$ -in. shim extending a short distance beyond the center sill channels, under which the drop forged center plate is riveted. A cast steel filler is placed between the center sill channels at the bolsters. The end sills are of 10-in., 30-lb. ship channels, with 5 16-in. end sill cover plates extending the full width of the car, connected to the under side of the top flange of the end sill channels and to the side sills.

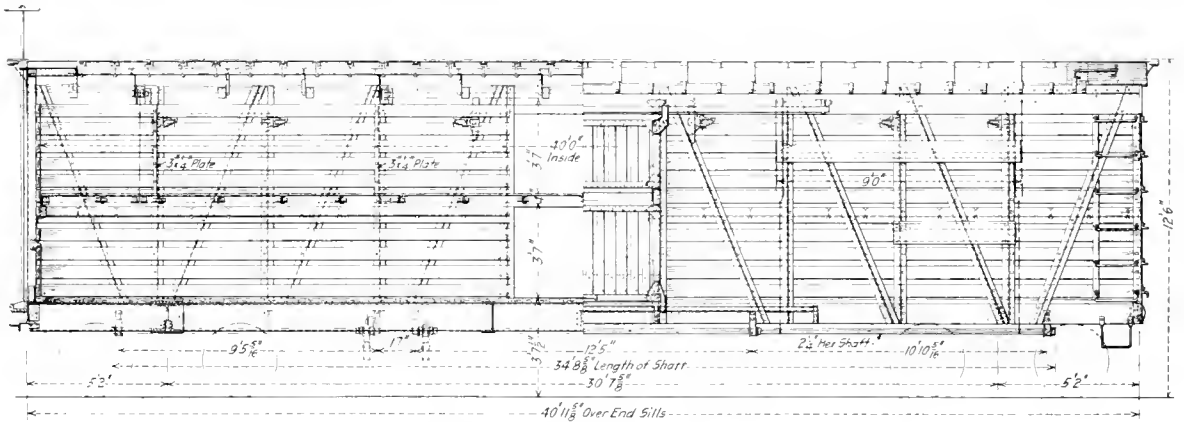

Elevation of Santa Fe Stock Car with Movable Decks

inside width is 8 ft. 8 in. and the width at the eaves 9 ft. 6¹/₂ in. The height from the rail to the top of the brake staff is 14 ft. 6 in. and to the top of the running board 12 ft. 6 in. When the upper deck is lowered the distance from the floor to the bottom of the upper deck is 3 ft. 7 in., and there is the same space between the upper deck and the underside of the carlines. With the deck in the raised position the distance between the floors and the under side of the deck is 6 ft. 10 in.

The car is designed with steel body framing, the sides forming trusses which carry the load, the center sills taking the buffing stresses only. The center sill is composed of two 12-in. ship channels, weighing 35 lb. per ft., spaced 13 in. from web to web, with a $\frac{1}{4}$ -in. cover plate 24 in. wide extending the entire length of the sill. The body bolsters are

There are two main cross-ties of pressed steel $\frac{1}{4}$ in. thick, with a 6-in. by $\frac{3}{8}$ -in. cover plate on top and a 6-in. by 7 16-in. cover plate on the bottom. At each cross-tie a pressed steel filler is placed between the center sill channels. The cross-ties are located 3 ft. 6 in. from the center of the car and with the end sills form auxiliary supports for the side framing, the main load being taken by the body bolsters. There are five small cross-ties of 5-in., 6.5-lb. channels, connected to the side sills and center sills by short angles. No spacers between the center sills are used at the small cross-ties. The floor supports are 5-in., 6.7-lb. Z-bars, extending between the bolsters. The sections are supported on the small cross-ties and fastened at the ends to the body bolsters and main cross-ties. From the bolsters to the end sills the floor is supported by 4 1/2-in. by 1/2-in. flat bars and by diagonal braces

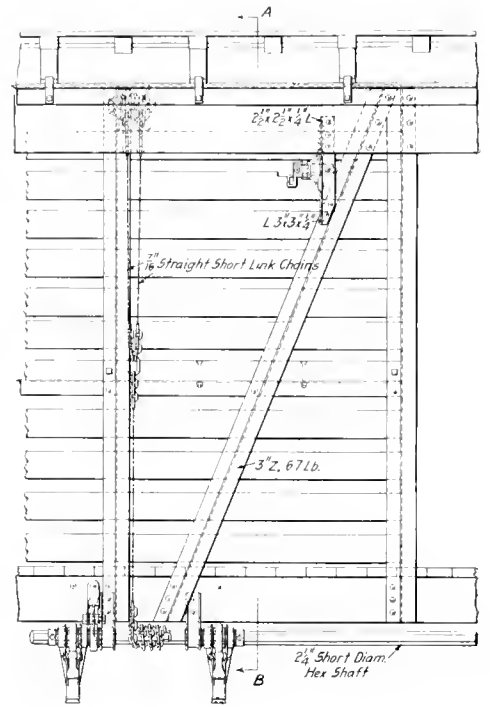
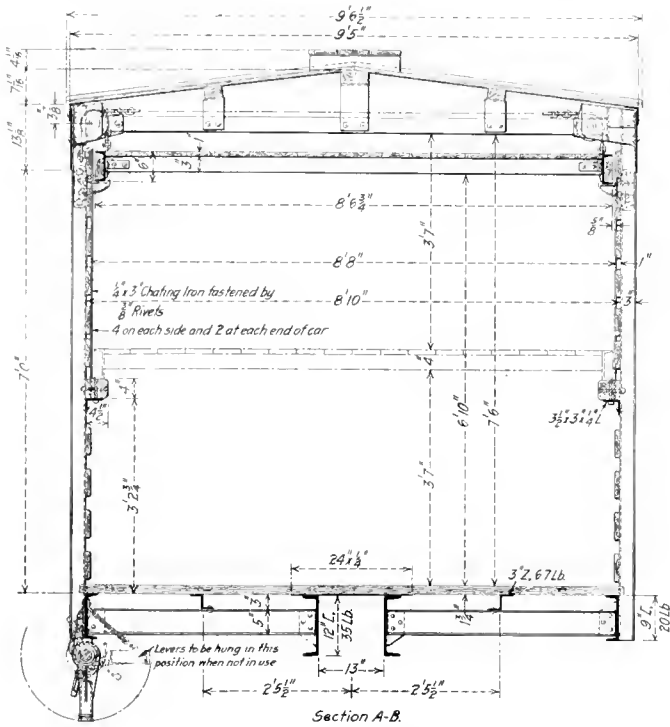

Cross Section Showing the Deck Operating Mechanism

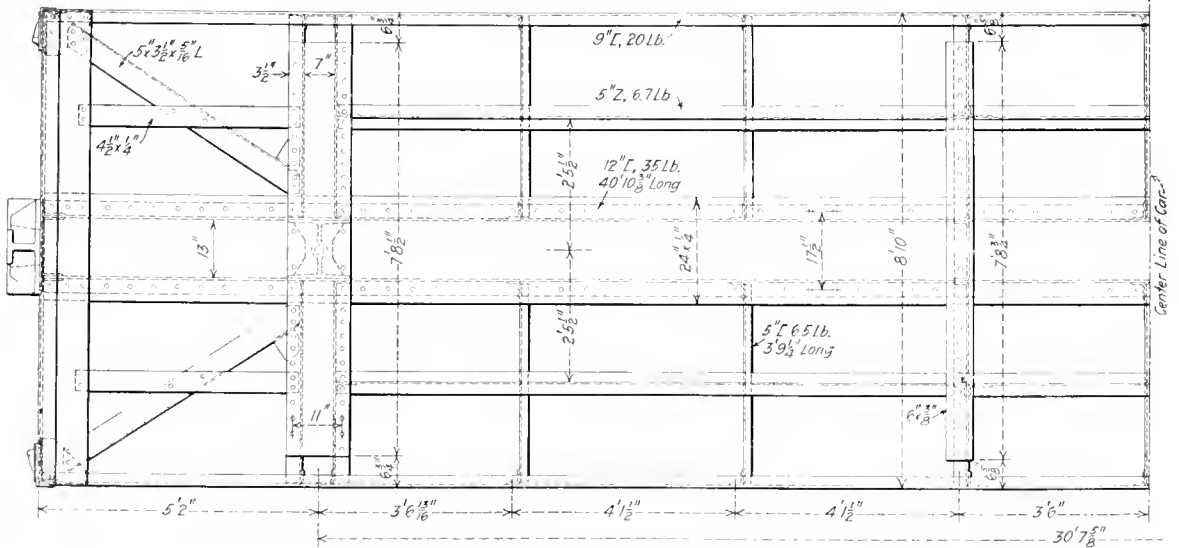
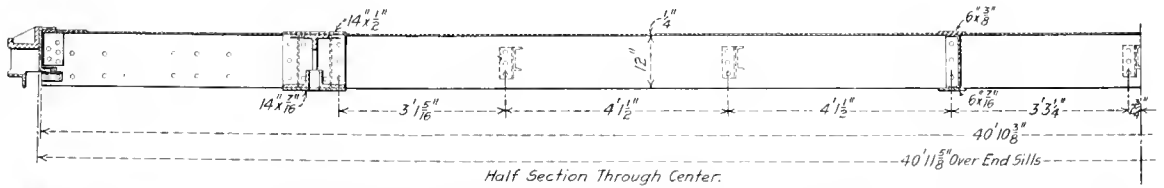

Steel Underframe for Santa Fe Stock Cars

of 5-in. by 3½-in. by 5/16-in. angles extending from the sides of the end sills to the body bolsters.

In the trusses which form the sides of the body frames the posts and braces have been fastened to the outside of the side sills and to the inside of the side plates, thus reducing the eccentric loading of the posts and braces. The side sills are

flanged and extending out from the end posts 3½ in. The end of the roof of the car is formed by a ¼-in. plate 2 ft. 1 7/16 in. wide, riveted to the side plate angles and to the flange of the end plate. This roof plate is reinforced with three 3-in., 4-lb. channels, to the ends of which are fastened supports for the ridge pole and purlines. At the inside edge

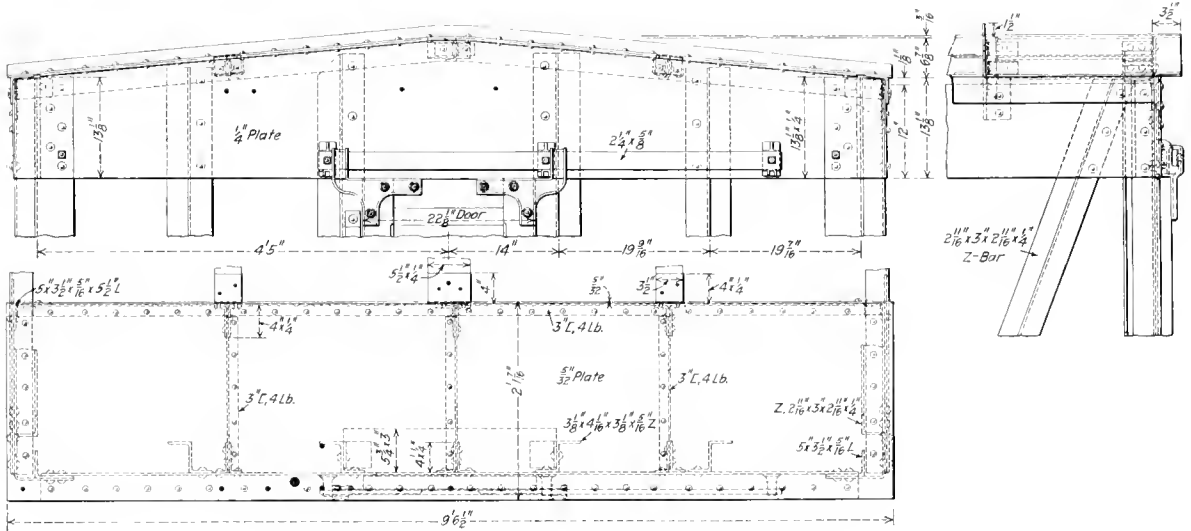

Detail of the Top End Connection for the Santa Fe Stock Cars

9-in., 20-lb. channels, extending between the end sills. The side posts and braces are of Z-bars ¼ in. thick, with 3-in web, weighing 6.7 lb. per ft. The door posts are also Z-bars, 5/16 in. thick, with 4 1/16-in. web, weighing 10.3 lb. per ft., while the corner posts are 5-in. by 3½-in. angles, 5/16 in. thick, weighing 8.7 lb. per ft. The side plate is formed of a 5-in. by 3½-in. by 5/16-in. angle, to which is riveted a

of the plate is a 1½-in. flange, over which the roof sheets are lapped. The carlines are 14 in number and are made of 3-in., 4-lb. channels. Ten of them are bent to the form of the roof and secured to the side plates with 5-in. by 3½-in. angles. The other four are straight and are riveted to the malleable roller housing brackets.

The flooring is 1¾-in. square edge long-leaf yellow pine

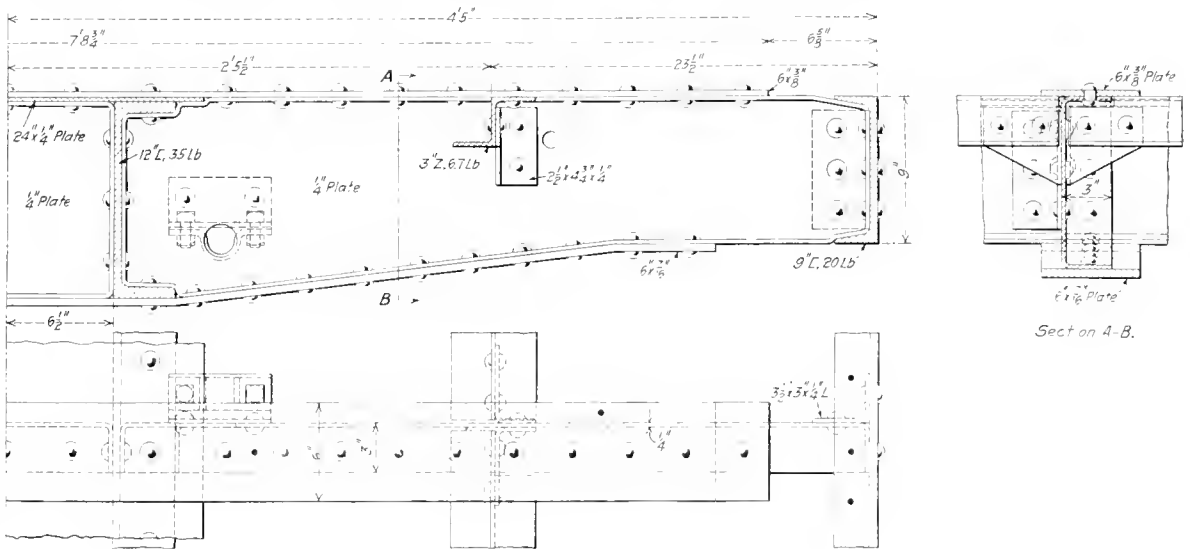

Details of Main Cross-tie - Santa Fe Stock Car

¼-in. plate 12 in. wide, this plate forming a connection for the posts, braces, door tracks, etc. The end posts are four Z-bars 5/16 in. thick, with a 4 1/16-in. web, weighing 10.3 lb. per ft. To the top of the end posts is riveted a ¼-in. plate, 13½ in. wide at the side plate, with the upper edge

riveted to the underframe with 3/8-in. wagon box rivets. The slats are of the same material, those on the sides being 1 in. by 5½ in., while on the ends they are 3/4 in. by 5½ in. The slats are secured to the doors, sides and end posts with wagon box rivets and to the corner posts and fillers

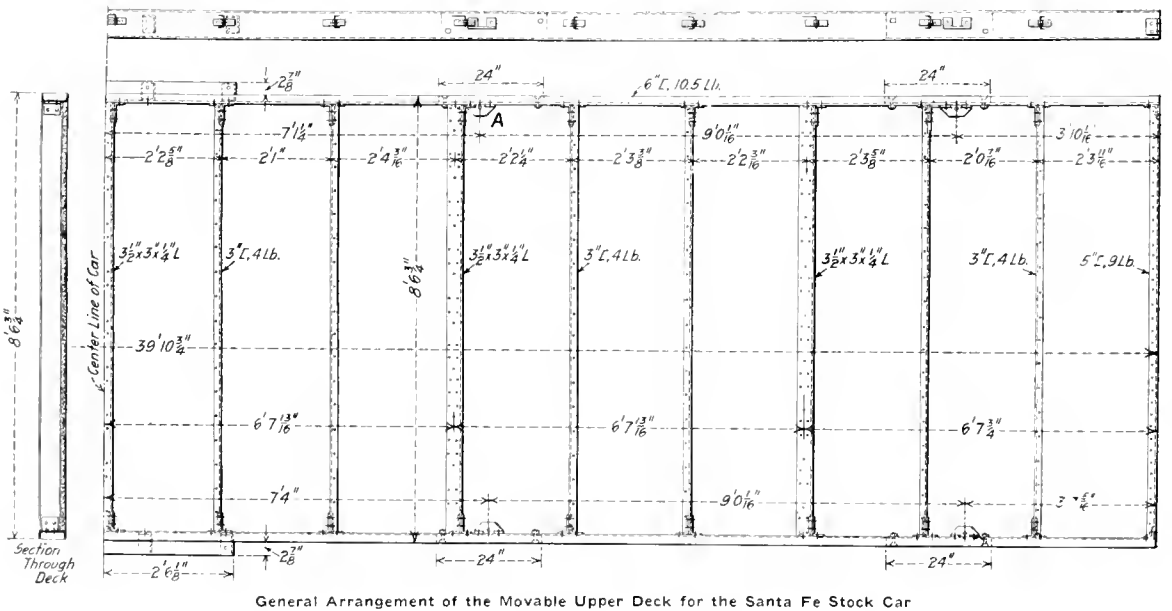
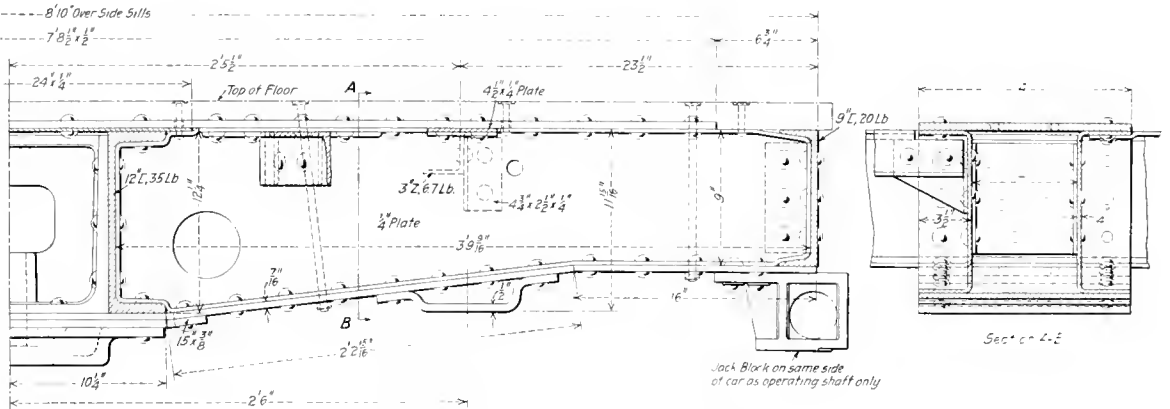
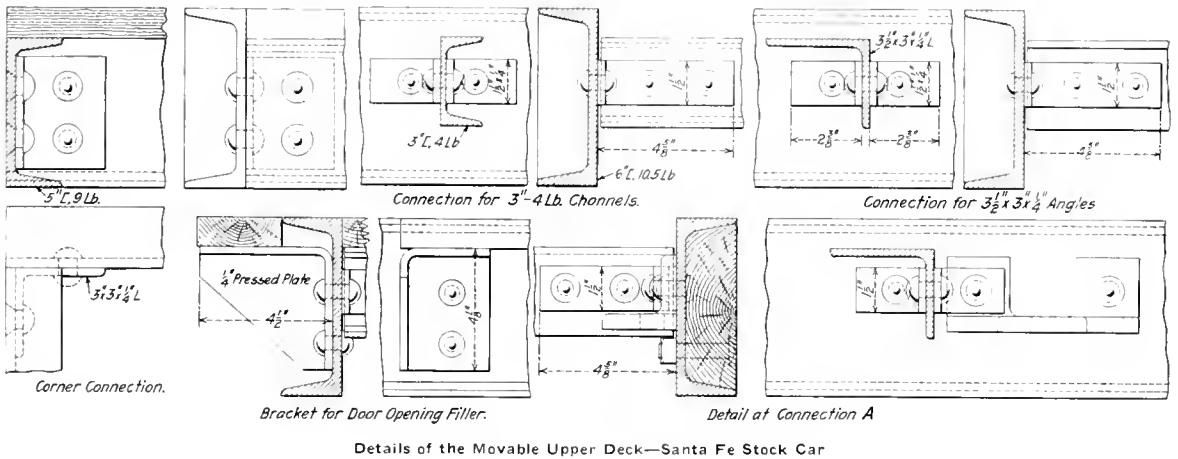

with carriage bolts. The roof boards are 13/16 in. by 5 1/4 in. tongued and grooved, supported by the ridge pole and by one purline on each side of the car. The roof is of the standard Railway Equipment Company's flexible metal type, the sheets being No. 25 Birmingham gage. Outside metal roofs were applied to these cars so that they could more readily be made available for loading with wheat by lining with paper. It is planned to use these cars in that way in case of a shortage of grain cars.

The side door opening is 5 ft. 1 in. by 6 ft. 10 in. Separate side doors are provided for the upper and lower decks, the upper doors being suspended on 5/8-in. by 2 1/4-in. tracks, while the lower doors run on tracks of 1 1/2-in. heavy steel pipe, which sets below the floor. End doors are provided for both the upper and lower decks.

The movable upper deck is in one section. The sides of the frame are 6-in., 10 1/2-lb. channels and the ends are 5-in., 9-lb. channels. There are five cross beams of 3 1/2-in. by 3-in. by 1/4-in. angles, between which are two 3-in., 4-lb. channels also running transversely. The floor is of 1-in. yellow pine running lengthwise, bolted and riveted to the cross beams. A bracket extends out from the frame at the door openings to prevent stock getting their feet between the door and the deck. The deck when lowered rests on yellow pine stringers supported by 3 1/2-in. by 3-in. by 1/4-in. angle irons extending around the car and riveted to the posts and braces.

On each side of the movable deck four 7/16-in. chains are attached. These chains run up to the side plates, where they pass over pulleys. The chains from one side are carried across the car where they run over another pulley and are joined to the opposite chain which is carried down to the operating shaft. The location of the operating chains is shown by the dotted lines on the side elevation. The operating shafts extend a short distance beyond the bolsters at each end of the car. Attached to the shaft near the door openings are two levers and a detaining pawl. The levers have ratchets and pawls for controlling the ascent or descent of the deck. The fact that there is but one operating shaft greatly facilitates the work of moving the deck. It has been found that one man can raise or lower it, either operation being performed in two minutes. On future orders but one operating lever will be provided. To hold the deck in raised position there are six malleable iron brackets on each side of the car, which can be swung in under the channels which form the side of the frames and locked by pawls. Patents have been granted on the devices for operating the movable upper decks.

These cars have Andrews cast steel side frame trucks with a wheel base of 5 ft. 4 in. and cast steel truck bolsters. The draft gear is of the friction type, Miner Class A-10-B. The couplers have 5-in. by 7-in. shank and 9 1/8-in. butt. The air brake is the Westinghouse schedule K C-1012.

IMPORTANCE OF PROPER LOADING OF CARS*

BY W. H. BEITCHER

Master Car Builder, Cincinnati, Indianapolis & Western, Indianapolis, Ind.

Accepting or running a car improperly loaded may mean a disastrous wreck, the loss of human life, a large monetary loss, tying up the railroad for many hours, the expensive cost of transferring loads, and in addition to all this it will create ill feeling between interchange inspectors concerning the transferring of loads. Great care should be taken in selecting cars for loading. Where improper cars are used there is considerable extra work for the various departments of the railroad, and the shippers are liable to suffer. It causes delayed shipments and claims which many times mean a large loss to the railroad.

* From a paper read before the annual convention of the Chief Interchange Car Inspectors' and Car Foremen's Association, Indianapolis, Ind., October 3, 4 and 5, 1916.

How many keep thoroughly conversant with the M. C. B. Loading Rules, and how many make it an important part of their business to go to the shipper and show him how to load the material he is about to ship, or to assist him in procuring the proper cars? While passing through Illinois one day last June I noticed a shipper loading a load of logs in such a way that no good thinking inspector would have accepted them in interchange. I told him in a kindly way that he was loading his logs improperly. It seemed that he had never received the rules governing the loading of logs, and he said he would be only too glad to read them. I left a copy with him and from that time we have never received a bad load of logs from this point. No doubt some shippers will want to be arbitrary, but he who is held responsible must show this sort of man that we mean business, and that the load will have to be loaded properly and in accordance with the rules. Car inspectors should keep the loading rules ever before them as a safeguard against loss of life, loss of lading and damage claims.

REDUCING BREAKS-IN-TWO ON THE SANTA FE

In discussing the handling of trains before the Car Foremen's Association of Chicago, H. R. Lake, trainmaster of the Santa Fe at Emporia, Kansas, told of the measures which have been taken to reduce the number of breaks-in-two on the eastern division. Each month a circular is issued showing the number of breaks-in-two for the preceding month, with a comparison with the figures for the last six months and the general average for the year. In another tabulation is shown the breaks-in-two charged to each engineman for the preceding two months following which is the record of each engineman for the year past. The breaks-in-two are classified between freight and passenger trains and also as to whether they occurred while starting, stopping or running. The percentage of the trains operated on which breaks-in-two occurred and the percentage of the totals for which each individual engineman was responsible are given. A further classification according to the cause as ascertained by investigation shows in detail the causes which contributed to the parting of trains.

The analysis of the breaks-in-two for the year 1916 showed that of the total number 45.5 per cent occurred while trains were stopping, 24.5 per cent while trains were starting, 27.2 per cent while running and 2.8 per cent while switching.

The contributing causes in detail were as follows:

Draft gear:	
Drawbar pulled out	2.8 per cent
Drawbar broken or defective	11.6 per cent
Draft timbers pulled out	8.8 per cent
Sleeve bolts broken	5.1 per cent
Defective draft bolts and timbers, broken tail pins, broken continuous rod	5.0 per cent
Total	33.3 per cent
Couplers and uncoupling devices:	
Knuckle broken or defective	12.3 per cent
Defective couplers and drawbars	5.1 per cent
Knuckle opened	5.1 per cent
Knuckle worn	4.4 per cent
Defective lock block	4.0 per cent
Lift lever raised, lift rod key broken or defective, short uncoupling chain	2.7 per cent
Total	33.6 per cent
Air brake:	
Burst air hose	7.2 per cent
Air set from rear, defective triples and train lines	7.3 per cent
Total	9.5 per cent
Miscellaneous:	
Carrier irons down, low drawbars, cars buckled, etc.	3.6 per cent

On account of the circulars on breaks-in-twos marked reduction in the number has been effected.

SHORTAGE OF COAL IN DENMARK.—Denmark possesses no coal mines, and supplies must be imported, amounting to about 3,500,000 tons annually. The closing of English ports make the country depend on Germany for its supply.

AIR BRAKE ASSOCIATION CONVENTION



THE Air Brake Association met for its twenty-fourth annual convention at the Hotel Chisca, Memphis, Tenn., May 1-4, 1917, T. W. Dow, of the Erie Railroad, presiding. At the opening session T. C. Ashcroft, mayor of Memphis, welcomed the association.

PRESIDENT'S ADDRESS

In his address Mr. Dow emphasized the necessity of having close co-operation between the railway mechanical organizations and dwelt on the importance of careful deliberation in matters pertaining to the reports and recommendations of the association. He also spoke of the demands which will be made on the railroads during the war, which render it imperative that the utmost efficiency be secured in all branches of the service and particularly in the air brake.

FUNCTIONAL INTERRELATION BETWEEN THE COMPONENT PARTS OF THE AIR BRAKE SYSTEM

BY W. E. DEAN

Because of the complexity of the air brake system, many people, in their close attention to one phase of the air brake problem, overlook the other phases. For instance, many relate wheel sliding directly to braking power or braking ratio, and forget that there are many more factors involved. Again, air brake devices frequently are given close scrutiny as to the delivery and release of air at the brake cylinder, without tracing the braking problem right on through from that point to the wheel and to the rail. It may be surprising to state that the air brake system for a train not only includes the more obvious parts such as air compressor, triple valve, etc., and the foundation brake gear, but also the truck and car construction, the wheels and the rails, and even the road bed and the weather. In applying brake shoes to a pair of wheels a balance of equal frictional forces is set up, the brake shoe friction tending to slide the wheels, and the wheel-rail friction keeping the wheels in rotation. However, if the brake shoe friction exceeds the maximum possible wheel-rail friction, or adhesion, that is, if the pull of the brake shoes tending to lock the wheels is a greater force than the pull of the rail, which tends to keep the wheels turning, the wheels, of course, will slide. Figs. 1 and 2 portray the relation between adhesion, braking ratio and efficiency factor in this balance of forces. By "adhesion" is understood the limiting value of adhesion

between wheel and rail beyond which more thrust or resistance cannot be given by the rail. The limiting value for adhesion will depend on the condition of the wheel and rail surfaces in contact, which in turn is dependent on many things: weather conditions (humidity and temperature); foreign substances, such as sand or frost, etc. A value of 25 per cent is the average generally taken for a clean dry rail, though it may go as high as 30 or 35 per cent with the presence of sand or as low as 12 or 15 per cent where frost is found.

By "braking ratio" is understood the relation between

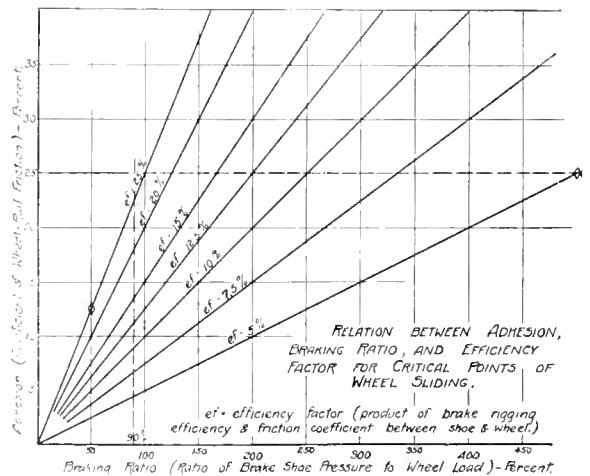

Fig. 1—Relation Between Variables Determining Critical Point of Wheel Sliding

the nominal braking force applied to a pair of wheels and the weight on those wheels. We speak of "nominal" braking force because the braking ratio does not consider losses in force transmission from the brake cylinder to the wheels.

In order to find what this braking force means in the way of brake shoe pull on the wheels it is necessary to multiply it first by the efficiency of the brake rigging and then by the coefficient of friction between shoe and wheel. The com-

bination, or product, of this rigging efficiency and friction coefficient is called the "efficiency factor". The braking ratio for a car multiplied by this efficiency factor gives the retardation factor, or actual retarding force in percent of the car weight. When this retarding force tends to exceed the limiting adhesion the wheels will slide.

Whether or not wheels slide, therefore, depends on the adhesion and the efficiency factor as well as on the braking force. Reference to Fig. 1 will show that where the adhesion is 25 per cent wheels may slide with anywhere from 100 per cent braking ratio (where the efficiency factor is 25 per cent) to 500 per cent (where the efficiency factor is but 5 per cent). Again, wheels may slide with 50 per cent braking ratio where the adhesion is but 12.5 per cent and the efficiency factor is 25 per cent. From this it is readily

friction between this jaw and the journal box prevents the latter from moving up or down freely, with the result that the weight on that pair of wheels may be suddenly relieved in passing over a low spot in the track, and the wheels slid. To keep the braking force the same and decrease the weight is in effect to increase correspondingly the braking ratio. If the balance of forces is in the neighborhood of the adhesion limit the wheels are very likely to slide. The remedy here is to balance this brake shoe pressure by applying a similar brake shoe pressure from the other side. In other words, it is to use a clasp brake with equal and opposite shoe pressures on each side of the wheel. To have these two opposing shoe pressures differ in value is only to temporize, or dally with, the problem.

In connection with wheel sliding mention was made of



T. W. Dow (Erie)
President



C. H. Weaver (N. Y. C.)
Vice-President



F. J. Barry (N. Y. O. & W.)
Vice-President



F. M. Nellis (W. A. B. Co.)
Secretary



Otto Best (Nathan Mfg. Co.)
Treasurer

OFFICERS OF THE AIR BRAKE ASSOCIATION

appreciated that wheel sliding is not solely dependent upon braking ratio.

Fig. 2 illustrates the same relations in another way. It is here seen that with a constant adhesion the braking ratio required to slide wheels will be decreased in proportion as the efficiency factor increases.

There is one phase of wheel sliding which has received scant attention, viz., the inability for a six-wheel truck to equalize weight freely from one pair of wheels to another when a brake equipment is used which applies a heavy unbalanced shoe pressure to one side of a wheel only. When a single brake shoe is applied to a wheel the side thrust must be opposed finally by the opposite pedestal jaw. The

braking ratio and efficiency factor. There is an important interrelation between braking ratio, type of foundation brake gear, type of brake shoe, efficiency factor and speed, which is illustrated in Fig. 3. This is a graphical summary of the values for efficiency factors given by S. W. Dudley in a paper presented before the American Society of Mechanical Engineers in New York, February 10, 1914. These values were selected from some of the best stops which were made in 1913 during the extensive Atlantic City Brake Tests of the Pennsylvania Railroad.

You will note that the efficiency factor decreases as the braking ratio is made greater. For instance, the efficiency factor for 125 per cent braking ratio, the clasp brake and a

speed of 60 m.p.h. is .103. For 180 per cent braking ratio it is only .085, all other things remaining the same. You will note as well that the efficiency factor is higher the lower the speed, with any given conditions of braking ratio, type of brake shoe and foundation brake gear. The type of brake shoe, whether plain or flanged, will also affect the value of the efficiency factor as shown in the scale of abscissae at the

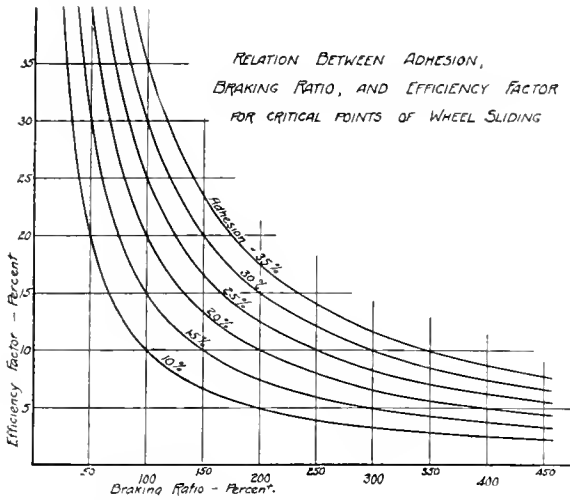

Fig. 2—The Relations Shown in Fig. 1 Illustrated In Another Way

bottom of the chart. The efficiency factors for the flanged shoe are in every case about 20 per cent higher than for the plain shoe. The successful use of the flanged shoe, however, seems to be limited to the clasp brake because of wheel flange troubles and slid flat wheels arising in its use with the single shoe brake. And finally it will be observed that in every case the efficiency factor for the clasp brake is higher than for the single shoe brake.

A functional interrelation of great interest to those who

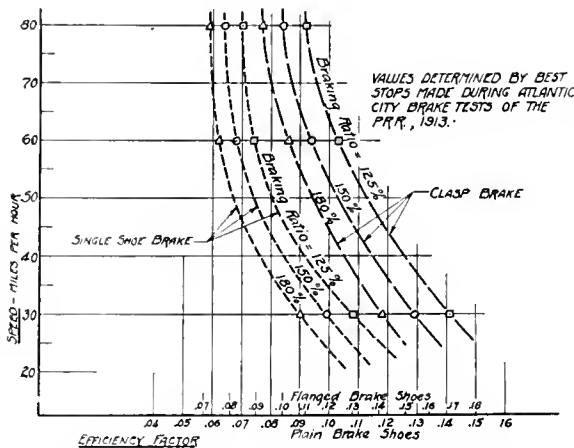

Fig. 3—Efficiency Factors for Stops from Various Speeds With Clasp and Single Shoe Brake Gears and Plain and Flanged Shoes

have to deal with the air brake problem is the one existing between the stop distance for a train, on the one hand, and the speed of the train, the grade, the braking ratio, the efficiency factor, and the time required to get the brakes applied, on the other.

Fig. 4 illustrates this interrelation in a graphic manner.

The first line gives the basic, or 100 per cent, conditions to afford a basis for all comparisons. The speed is 60 m.p.h., the track level, the braking ratio 150 per cent, the efficiency factor 8.5 per cent, and the mean time required to get the brakes into action is 0.7 second. Where these conditions hold the stop distance will be 1,000 feet. In each case these basic conditions hold except where otherwise noted.

Due to the close interrelation and balance in functions existing between the many parts which go to make up the air brake system, care must be exercised to see that a change in one part, more or less desirable, does not introduce changes

CONDITIONS	SPEED	GRADE	BRKING RATIO	EFFICIENCY FACTOR	TIME TO GET BRKES APPLIED	STOP DISTANCE
1 Basic (100%) Conditions	60 mph	Level	150%	.085	.7 sec.	1000 ft.
2 3% Increase in Speed.	63	Level	150%	.085	.7 sec.	1100 ft. 10%
3 1% Grade Descending.	60	One%	150%	.085	.7 sec.	1080 ft. 2%
4 20% Decrease in Braking Ratio.	60	Level	120%	.085	.7 sec.	1240 ft. 24%
5 20% Decrease in Efficiency Factor	60	Level	150%	.068	.7 sec.	1240 ft. 24%
6 200% Increase in Time to Get Brakes Applied	60	Level	150%	.085	1.4 sec. 100%	1760 ft. 76%

Fig. 4—Effect on Stop Distance of Variations in Speed, Grade, Braking Ratio, Efficiency Factor and Time to Get Brakes Applied

elsewhere which would render useless or quite defeat the good effects desired.

Frequent reference has been made to the superior performance of the clasp brake as compared with that of the single shoe brake. It must be stated with much emphasis, however, that in every case reference was made to a clasp brake designed and installed on correct engineering principles. A clasp brake improperly designed and poorly installed, as for instance on a truck the construction of which does not lend itself to a suitable clasp brake, may not only fail to deliver the performance desired but may actually be less satisfactory than the single shoe brake which is displaced.

CLEANING AND LUBRICATING BRAKE CYLINDER PACKING LEATHERS

BY R. C. BURNS

In the past it has been the practice when cleaning brake cylinder piston packing leathers to remove the non-pressure head and piston and thoroughly clean the piston and leather at the car on the repair, or shop track, and in many cases, kerosene oil is used to clean the brake cylinder packing leather, as it is almost impossible to remove the heavy grease from the leather without the use of some mineral oil, especially during cold weather, which seriously affects the leather filler, and as a result, leathers are placed in cylinders which show no visible defects, but fail when making the brake cylinder leakage test, after being in service a short time.

In order to eliminate these improper practices and to afford better facilities for cleaning and testing these leathers, the piston and leather should be taken to a shop provided with the proper facilities for cleaning and testing, in order that they may receive the same careful attention as is now recommended for triple valves. When transmitting the piston and leather to the shop, care must be taken to provide a suitable shield to protect it from damage either by coming in contact with other devices or from dirt.

When cleaning the brake cylinder packing leather, the follower plate should be removed and the leather thoroughly cleaned, without the use of any mineral oil, and if no visible defects are found, the leather should be re-applied to the piston and tested in a cylinder of standard size for the leather under test. The cylinders of the various sizes

to be used for conducting these tests should be equipped with apparatus in order to conveniently conduct the test, similar to that shown in Fig. 1.

An S-3 brake valve is employed for admitting air to the brake cylinder when conducting this test as this valve can be more conveniently and accurately operated for admitting and discharging air to and from the cylinder than two standard cutout cocks otherwise required. The feed valve is adjusted to 55 lb., which pressure is admitted to the cylinder, and the readings noted from an initial cylinder pressure of 50 lb., in order to avoid any false leakage due to the change in the temperature of the air.

The special apparatus above referred to for testing brake cylinder piston packing leathers is designed to provide for a 6-in. piston travel, whereas, the Proceedings of the Master Car Builders' Association, Volume 50, Part 2, for the year 1916, on page 810, states that the piston travel should be adjusted to not less than 5½ in. or more than 7 in. On this same page, it also states brake cylinder leakage must not exceed 5 lb. per minute from an initial cylinder pressure of 50 lb., while on page 830, it specifically states that all tests must be made with an 8-in. piston travel, except when

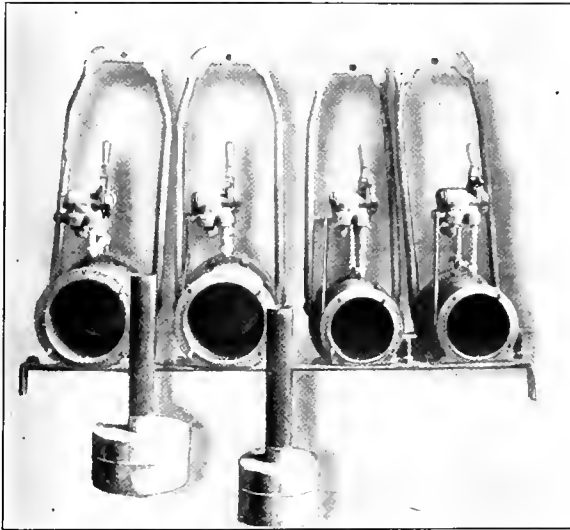

Fig. 1—Cylinders for Testing Packing Leathers

otherwise specified. This is rather confusing, and we would suggest that brake cylinder leakage tests be made with a piston travel of 6 inches.

We would also recommend that an additional brake cylinder leakage test be provided for cars arriving on repair tracks that are not due for periodical attention to the air brake equipment, as follows: The air brake equipment to be inspected, tested and the necessary repairs made, and the brake cylinders tested, and if the leakage exceeds 12 lb. per minute from an initial cylinder pressure of 50 lb. with a 6-in. piston travel, the cylinder and leather should be given the necessary attention.

When the brake cylinder is given attention, the expander ring should also receive a careful inspection and test by the use of a special gage.

The above practice as outlined for the cleaning, lubricating and testing of brake cylinder packing leathers has been followed on one particular railroad for a period of about one year and the results obtained have been very satisfactory. When the piston and leather have been applied to the brake cylinder on the car, the present standard test should be made to eliminate all possible leakage which may exist in the brake cylinder pressure head and its connecting pipe.

The leathers which were condemned by these tests, but could not be condemned by a visual inspection, were forwarded to the manufacturer to be re-treated, and after being returned, they were placed in service together with the new leathers for a comparative test which followed for a period of six months, with the result that in no case did the leakage of the re-treated leather exceed the leakage of the new leather. There is no question but quite a large percentage of discarded brake cylinder packing leathers can be reclaimed by this re-treating process.

DISCUSSION

Attention was called to the saving which this method would effect when a large number of packing leathers are cleaned. The present condition of the leather market makes it particularly desirable to reclaim packing leathers whenever it is possible.

RECOMMENDED PRACTICE

Under heading "Air Compressors," sub-heading "Location," the following should be added. Paragraph No. 1: The base of the bracket should have ample length and bearing on the boiler to insure adequate compressor support as well as to prevent injury to the boiler.

Paragraph No. 3. The number, size and spacing of the studs for securing the bracket to the boiler should be according to good engineering practice; the number and size of studs to depend upon the distance the compressor is out from the boiler. It is recommended that not less than six 1½-in. studs properly spaced be used where the compressor is hung low.

Under sub-heading "Repairs to Air Compressors," the following to be added as Paragraph No. 2: Air Compressors returned to the shop for repairs should be thoroughly cleaned in boiling lye before dismantling for inspection.

Under sub-heading "Repairing and Condemning," the following should be added to Paragraph No. 4: Dimensions between piston heads when properly assembled to be as follows: 9½-in. compressor—18.675; 11-in. compressor—21.175; 8½-in. cross compound compressor—22.675.

Paragraph No. 5 to be changed to read: Piston packing rings for steam cylinders to be condemned when end of rings are 3/32 in. apart when placed in the smallest part of the cylinder.

The following paragraphs to be added: Piston packing rings for steam cylinders to be condemned when end of rings do not come together when placed in the smallest part of the cylinder.

Combinations of packing rings and air pistons should not be used when the difference between the thickness of the ring and the width of the groove is .005 in. or more.

Under heading "Brake Valves," sub-heading "Cut Out Cocks," Paragraph No. 1 to be changed to read: The double heading cut-out cock of the engineer's brake valve to be located in the cab and so placed that the handle points upward when cut out and turns down against the lug so that it stands crosswise of the pipe when cut in. If conditions prevent the use of a handle of full length, it should be cut off but in no case to be less than 23¼ in. long.

Under heading "Distributing Valve," sub-heading "Location," Paragraph No. 1 following the word "brackets" in the fourth line, the following words should be added: "bolted to the boiler, if possible."

Paragraph No. 2 to be omitted as this is included in Paragraph No. 1.

The following paragraph to be added: Distributing valve should be maintained in a condition to apply with a 5-lb. brake pipe reduction made with the automatic brake valve and to enable pressure to be graduated out of the brake cylinders in steps of about 8-lb. at a time.

The following paragraph to be added: Distributing valve

to be removed from the locomotive at least once in each six months, thoroughly cleaned, examined and tested in accordance with the prescribed code on the standard test rack.

Under heading "Brake Cylinders," sub-heading "Cleaning and Lubricating," Paragraph No. 2 to be changed to read: Packing leathers must not be cleaned with kerosene or any mineral oil, or with waste or rags that have been soaked in kerosene or mineral oil, as this destroys the filler placed in the leather by the manufacturers, opening the pores and causing the leather to become soft and porous.

Under sub-heading "Leverage," Article No. 6, the word "piston" to be changed to read "position."

Paragraph No. 10 should be omitted and the following paragraph substituted: Clasp brakes of proper design should be used on all passenger equipment cars.

The following paragraph should be added to follow Paragraph No. 11: Foundation brake gear on freight equipment cars to be suitable to withstand brake cylinder pressure of 85 lb., except where the empty and load brake is applied when 60 lb. cylinder pressure in both cylinders should be used as a basis in determining the strength of the rigging.

The following paragraph to be added: When locomotives or cars are in shops for general repairs, the foundation brake rigging should be thoroughly inspected and all excessive lost motion eliminated. All pins should be removed for inspection, pin holes trued up and new pins applied wherever necessary.

The feed valve test and the distributing valve test were also revised and the M. C. B. recommendations for hand brakes and brake beams were adopted. Some additions and changes to conform to the practices required by federal laws and various minor revisions of the code were made.

The report was signed by S. G. Down, chairman; H. A. Wahlert, N. A. Campbell, J. R. Alexander and H. A. Clark.

OTHER BUSINESS

There were more than 200 members registered and 150 guests. The secretary reported a good increase in the membership and also in the balance in the treasury during the past year. The association voted a considerable fund to be given to the American Red Cross. Papers were also presented on the Slack Action in Passenger Trains, Handling Trains on Heavy Grades, and the Life of Hose. These will be published later.

On Thursday Walter V. Turner gave a lecture, illustrated with moving pictures, on the operation of a triple valve and also showed lantern slides of freak inventions. On Wednesday Mr. Turner gave a lecture on the manufacture of shrapnel shell.

The following officers were elected: President, C. H. Weaver, N. Y. C. West of Buffalo; first vice-president, C. W. Martin, P. R. R.; second vice-president, F. J. Barry, N. Y., O. & W.; secretary, F. M. Nellis, Westinghouse Air Brake Co.; treasurer, Otto Best, Nathan Manufacturing Co.

ERIE DINING CARS WITH UNIQUE TABLE ARRANGEMENT

The Erie Railroad now has in service two new dining cars designed to give privacy to each two or four guests, as the case may be, and they were recently exhibited by the

company to a number of railway men and other guests at the Jersey City terminal. As the illustration indicates, the passengers sit facing one another within semi-enclosed compartments which occupy the central line of the car. There are two aisles—one on either side of the compartments. When seated the passenger is screened from view of all except persons passing in the aisle, and he has a good out-door view through the window at his side. The compartments accommodate 28 passengers; four persons may be seated at each of four tables and two persons at each of six tables. This arrangement greatly improves the conditions required for prompt and satisfactory service. The transverse partitions separating the compartments are 5 ft. 9 in. apart and the compartments are 4 ft. 10 in. wide. The aisles on either side of the compartments are 2 ft. 3 in. wide. The dining room is 45 ft. 1 in. in length.

The floor covering in the dining room is of maroon flexo-

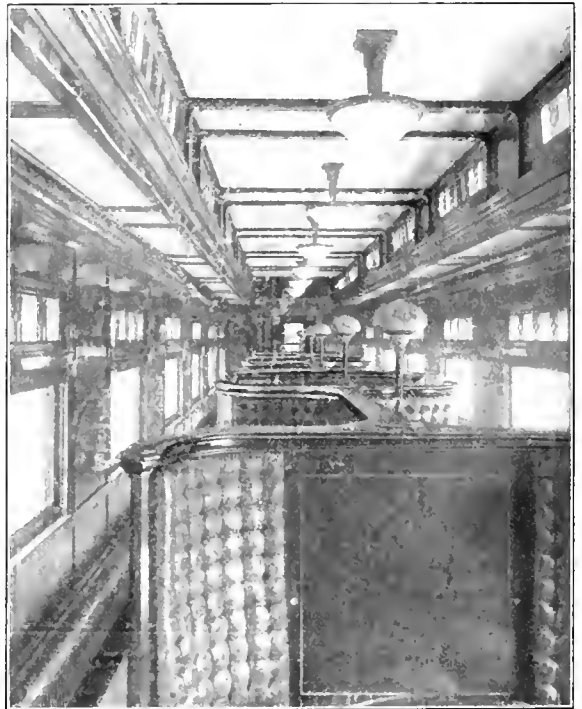

Interior View of the Erie Dining Car

lite, that in the passageway in front of the buffet and end of the car of 1/4 in. inlaid rubber, while the kitchen and pantry floors are covered with copper. The lamps in the dining room are all of the semi-indirect type affording ample illumination without unpleasant glare. The cars are 78 ft. 10 in. long, over end posts. They are of steel construction, with interior finish of Cuban mahogany. The Barney & Smith Company built the bodies; the Standard Car Truck Company designed the six-wheel built-up steel trucks.

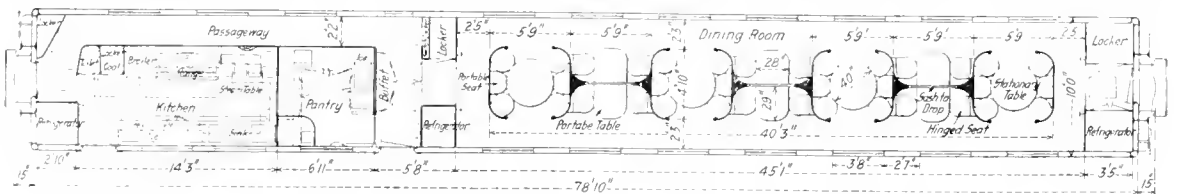

Floor Plan Showing the Arrangement of Tables in the Center of the Erie Dining Cars



PLAIN GRINDING MACHINES

An interesting application of a multiple friction disk drive is found in the Nos. 10 and 11 plain grinding machines built by the Brown & Sharpe Manufacturing Company, Providence, R. I. Fig. 1 shows a No. 11 machine. These machines have also wheel and work speeds and feeds that are entirely independent, and the drive is self-contained. Power is transmitted through a main driving shaft running in taper roller bearings at the rear of the machine and driven from a simple overhead countershaft.

A large pulley located centrally between the two roller bearings on the main driving shaft drives the wheel spindle with a belt running over two idler pulleys. Changes in wheel speeds are obtained by means of split pulleys on the wheel

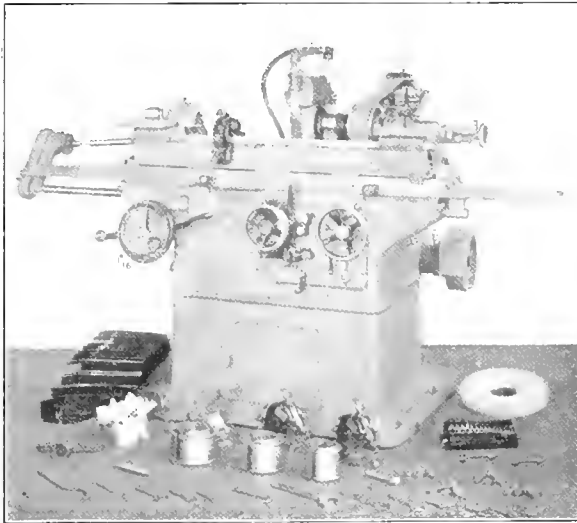

Fig. 1—Brown & Sharpe No. 11 Plain Grinding Machine

spindle which may be quickly interchanged without removing the belt. The idler pulleys run on taper roller bearings supported in a heavy swinging bracket so constructed as to follow the transverse movement of the wheel stand, thus keeping a uniform tension upon the driving belt regardless of the position of the grinding wheel. The slack in the belt due to the difference in diameter of the wheel spindle pulleys when changes in wheel speeds are made, is taken care of by the top idler pulley, which is provided with separate adjustment, making it possible for the operator to place the necessary tension on the wheel spindle driving belt. The work speed and table feed mechanism is built as a unit and is located in a case at the rear of the machine, being coupled directly to the end of the main driving shaft.

Fig. 2 shows the arrangement of the drive for the wheel.

Sprocket *A* at the end of the speed and feed case, is connected to the reversing mechanism and drives the table traverse. Driven sprocket *B* is located on the table reversing mechanism, which is built as a unit and fastened into the bed of the machine from the front. The headstock is driven from the speed and feed case by a sprocket *C* to a double sprocket *D*, acting as an idler, to a hardened splined sprocket *E*. A splined shaft *F* supported in bronze bearings under each end of the table and sliding in splined sprocket *E* transmits power to the end of table from whence it is carried to the headstock, through chains and sprockets

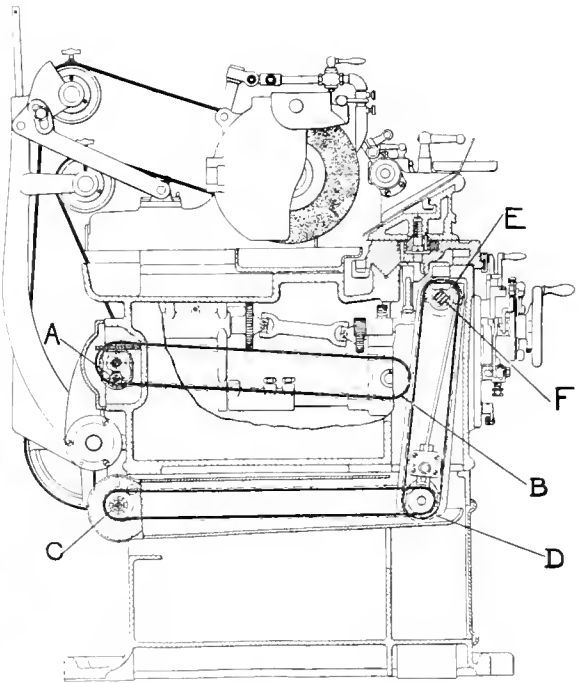

Fig. 2—Driving Mechanism for the Grinding Wheel

and a telescopic shaft with universal joints which permit the headstock to be moved longitudinally and the table to be set at an angle. The splined and telescopic shafts are clearly shown in Fig. 1.

The work driving plate is mounted upon a sprocket running on tapered roller bearings around a fixed spindle which firmly holds a deal centre in such a manner that it practically becomes an integral part of the headstock.

SPEED AND FEED CHANGING MECHANISM

The drive from the main shaft of the machine to the sprockets in the speed case that in turn drive the headstock

and table is of a multiple friction disk type. It enables the operator to start and stop work or table movements without shock and gives practically universal choice of independent speeds and feeds. Fig. 3 shows the interior of the case in which this mechanism is contained. From the shaft *I*, which is coupled to the main driving shaft of the machine, power is transmitted through gears to two separate driving shafts *G* and *H*, running at constant speed. These shafts carry a series of hardened steel disks, ground slightly convex, and each meshing with another series of hardened steel disks. The latter disks have a rim at their periphery, bringing the point of contact always at their extreme edge.

The driving shafts *G* and *H* are mounted in swinging brackets pivoted on the main driving shaft bearings. They are swung toward or from the driven shafts, carrying the driving disks toward or from the centre of the driven disks, thus obtaining the desired changes in the speed of the work or feed of the table by decreasing or increasing the radius of the driving disks. A continuous flow of oil from a pump directly connected to the main driving shaft furnishes lubricant for the entire case.

The control of the speed and feed case is governed by three levers grouped around a dial mounted at the front of the machine. A lever marked "Head" (at the left) serves to operate the set of disks that govern the head-stock or work speeds. Twelve indicated changes of work speed and the fine division between these indicated changes are available.

A second lever marked "Table" (at the right) serves likewise to change the rate of table traverse. The corresponding dial is graduated to read in inches per minute. Any de-

traverse mechanism and operates the ratchet mechanism of the regular automatic cross feed. As a result the full number of changes of feed that can be made with the regular cross feed mechanism are available. These may be increased or decreased by changing the speed of the table traverse mechanism with the table traverse feed change mechanism, giving practically a universal selection of feeds from the coarsest to the finest that are ever required. A positive safety lock prevents table traverse when the independent automatic cross feed is in operation.

"CISCO" RELIEVING ATTACHMENT

The Cincinnati Iron and Steel Company, Cincinnati, Ohio, recently designed a relieving attachment for engine lathes. It is driven from a gear on the outside end of the spindle. This gear replaces the spindle bushing and necessitates no change whatsoever in the spindle itself. It is engaged by an idler which in turn drives the change gears on the swinging quadrant. Six change gears are all that are required to obtain the correct changes for the following

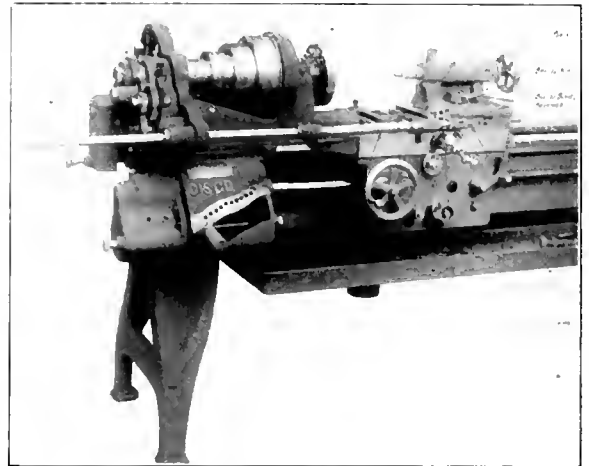

"Cisco" Lathe with Relieving Attachment

number of flutes: 1, 2, 3, 4, 5, 6, 7, 8, 10, 12, 14, 16, 20

The quadrant swings on a drive box which is bolted to the front of the head stock and contains the gears for driving the sliding shaft. This shaft is journaled in a bracket on the carriage and the sliding end may be made any length to suit any length of bed, therefore, not limiting the travel or position of the carriage when relieving. The drive from this shaft to the camshaft is through universal joints, a shaft and sleeve. This compensates for slide and swivel adjustments. The swivel can be turned to an angle of 30 deg. and all bottom and top slide adjustments can be made in connection with the relieving attachment exactly the same as in the regular lathe. Relieving can also be done in connection with the taper attachment. The camshaft runs in bronze bearings and is easily removed for placing the cams.

Two cams are provided with each attachment, single and double impulse. The cam operates against a hardened steel roller held in a hardened steel slide, this slide being connected to the top slide screw and has a spring rod with tap adjusting nuts which govern the amount of throw or relief required, or it can be made to hold the slide and roller away from the cam when the compound rest is required for regular work. The change gears are well guarded and an idle plate showing the gear arrangements is furnished. This attachment can be either applied when building the lathe or after the lathe has been built.

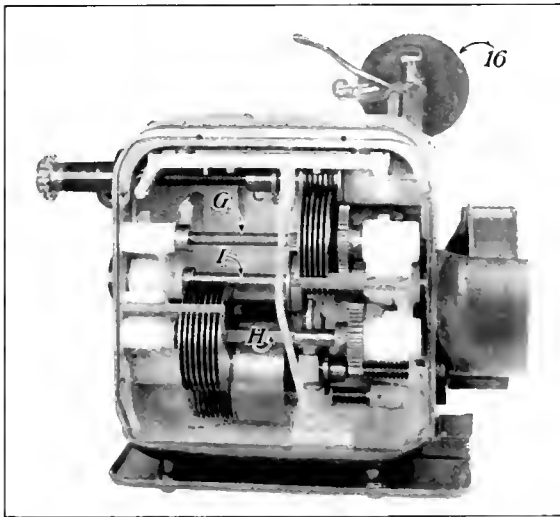

Fig 3—Interior View of Variable Speed Case for the B. & S. Plain Grinding Machine

sired change from 13 to 181 in. per minute may be obtained.

A third and longer lever operates the springs which hold the friction disks firmly in contact and serves to instantly start or stop both work and table simultaneously without stopping the grinding wheel.

INDEPENDENT AUTOMATIC CROSS FEED

These machines are provided with the independent automatic cross feed, which enables the wheel to be fed automatically into the work without traversing the table. This feature is desirable when the portion of work to be ground is not as great as the width of the grinding wheel. This independent automatic cross feed is driven from the table

LIBBY HIGH POWER TURRET LATHE

The Libby heavy duty turret lathe has been in use in railway shops on heavy bar and chucking work for a number of years. The manufacturers of this machine, the International Machine Tool Company, Indianapolis, Ind., has recently placed on the market a new turret lathe known as type C, which represents an improvement over the former design in accuracy and economy of production. In this machine care has been taken to provide ample power and rigidity and also to reduce to a minimum the labor required

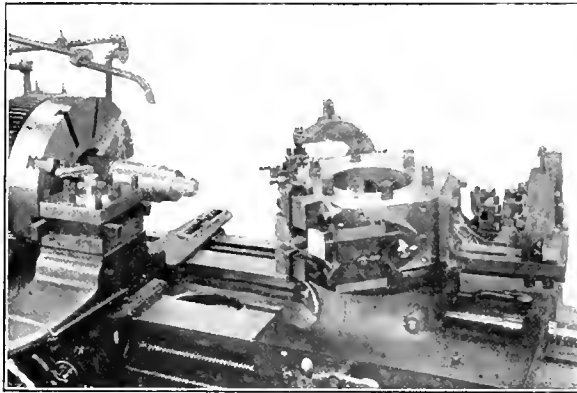

Libby Lathe Finishing Crank Pins from Bar Stock

of the operator. It has been used with good results on crank, crosshead and knuckle joint pins, washers and collars, valve rings and similar parts.

This machine has a swing over the ways of 26 in. and over the carriage of 24 in. with a 7 $\frac{1}{2}$ -in. hole through the spindle. The travel of the carriage is 72 in. As regularly furnished, the lathe carries a 22-in. 3-jaw universal chuck. If desired, a 4-jaw combination chuck or a collet chuck,

strains direct. The front way is undercut 15 deg. to receive long taper gibs for both the tool post and the turret slides, which take care of the side thrusts of both carriages.

The headstock is of the geared type with single pulley drive. The gears are of wide face and coarse pitch, the material being either steel or semi-steel. The chuck ring gear is 22 in. in diameter, and is keyed and bolted to an 11-in. flange forged on the spindle. The frictions are of large diameter and will carry the full capacity of the belt. The machine can be started and stopped under the heaviest cut without releasing the feed. The spindle is of high carbon steel threaded to receive the chuck, and has a taper seat for centralizing the chuck. Eight spindle speeds ranging from 8 to 142 r.p.m. are provided by the change gears. All spindle and shaft bearings in the headstock are of phosphor bronze. The spindle bearings are adjustable for wear and are provided with ring oilers.

The tool post carriage is of the side carriage type. There is no bearing on the back way, but instead a taper gibbed bearing is provided on the bottom of the front side of the bed. This construction permits the tool post to pass the chuck and allows the turret to come up flush with the chuck so that short, stocky tools can be used. A heavy, four-side, turret type tool post is provided. It can be locked rigidly in any of the four positions and clamped in any intermediate position desired. Stops are provided for each face of the turret and there is also a sight indicator for use in reproducing diameters. Forty-eight feeds are provided ranging from .50 in. to .0078 in. per revolution of the spindle.

The turret slide is of heavy construction, with a long bearing surface on the bed. It is gibbed horizontally and vertically and has a positive clamp to hold it stationary when using centers. The turret is of the hollow hexagon type 18 in. across the flats, with 4 $\frac{1}{2}$ -in. holes. It is mounted on a conical seat and centers by a lock pin. The lever which controls the lock pin also operates the clamp ring which holds the turret in position. There are 80 changes of feed ranging from .50 in. to .0039 in.

A power rapid traverse is provided for both the tool post

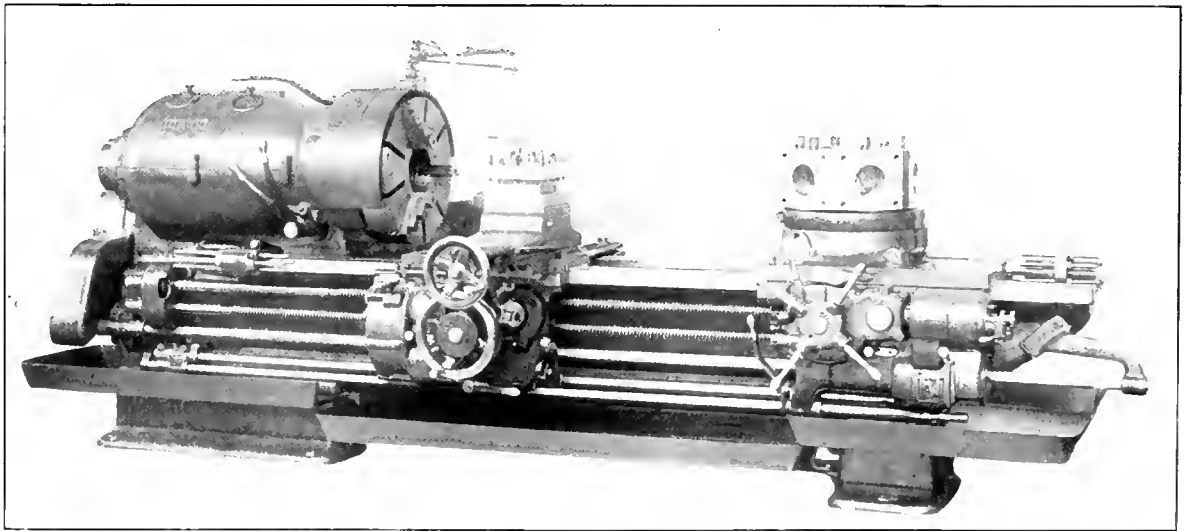

Type C Libby Lathe for Heavy Work

designed to take bar stock up to 7 $\frac{1}{4}$ in. in diameter can be furnished. The bed and the headstock housing are cast in one piece. The bed is cross-ribbed and has a longitudinal rib through the center. The ways are broad and flat and provide extensive bearing surfaces for the carriages. By their positions relative to the spindle they receive the cutting

and turret carriages, each being independent of the other. None of the headstock or feed gears is used in the rapid traverse mechanism. The hand movement of the slides is by means of a hand wheel on the tool post slide and a pilot wheel on the turret slide. One revolution of either wheel advances the slide one inch, which gives sufficient power to

operate the slide while the machine is cutting. Throughout the machine provision for insuring oil reaching any part that requires it has been made. The machine will cut any standard thread from $\frac{1}{2}$ -in. lead down, including $11\frac{1}{2}$ threads per inch. Among the special attachments that can be furnished for this machine are oil pans and pump, a taper attachment, bar feed, two-speed countershaft and standard or special tools for chucking or bar work.

The turret lathe is regularly furnished with a countershaft having 18-in. pulleys and designed to run at 360 r. p. m. If it is desired to use motor drive a motor of any make or type, either constant or variable speed, running at from 1,100 to 1,500 r. p. m. and having a capacity of about 20 hp. may be used.

CINCINNATI PLANER

A new design of a 50 in. by 30 in. planer has recently been developed by the Cincinnati Planer Company, Cincinnati, Ohio, in which several interesting features are included.

The bed is of the latest design in which the top between the vees is closed up in the casting excepting at the gearing sections. This makes a strong box section and eliminates danger to the operator. The bed is bored to receive the shaft bearing and all driving gears are inside the bed supported by two bearings, thus eliminating the overhung construction. The loose pulleys are equipped with self-oiling bronze bushings, and the driving pulley is made of aluminum. The shifting mechanism is of a new design in which the cam slots are milled into the outside diameter of a round casting. This cam is supported in a substantial

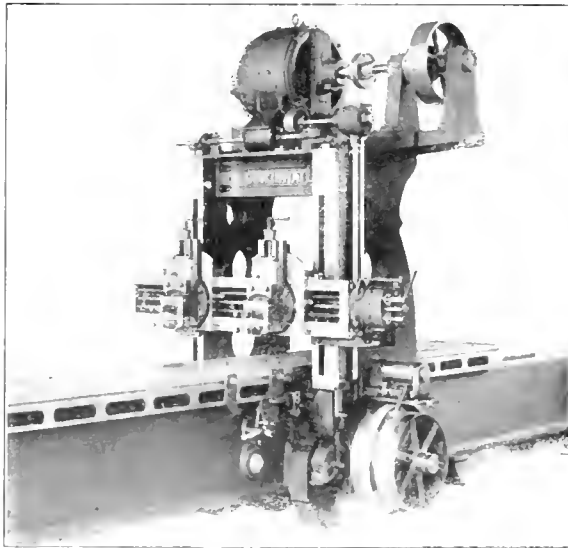

New Design of 30-in. by 30-in. Cincinnati Planer

bracket bolted against the housings, which also provides an extra support to the belt arms. A drip pan is attached to the lower side of the bracket which catches the oil from the shifting device, thus leaving the belts dry.

The table is of box type being closed at the bottom as well as the top. The housings are of box type and are carried to the bottom of the bed. They are fastened to the sides by belts and dowel pins and are further secured by a tongue and groove arrangement.

The cross rail is of entirely new design. The reinforced arch on the back is made to a true half circle. This section

is used so as to provide additional strength for the torsional stress imposed by overhung cutting tools. The saddle is carried up to the full length of the harp. An extra clamp is provided at the extreme end which provides the necessary rigidity. The saddle is taper gibbed at the top and the clapper box is provided with a rectangular shaped clamp instead of the circular clamp arrangement as was provided in the old type.

The machine shown in the photograph is provided with rapid power traverse to the rail heads. It is driven from

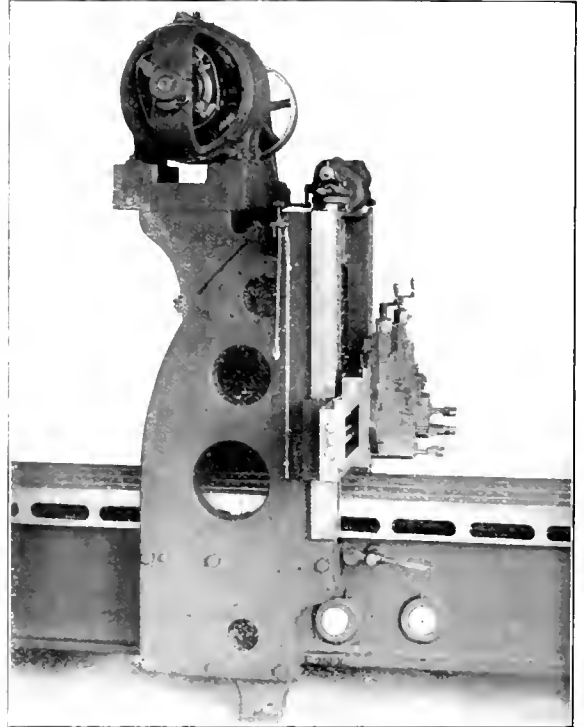

Left Side View of the Cincinnati Planer

the top of the machine through a pair of bevel gears and friction clutch which is manipulated from the end of the cross rail and is within easy reach of the operator. It is impossible to engage the feed and rapid traverse at the same time.

The housings are provided with a set of pads onto which the brackets can be fastened for the motor drive arrangement at any time after the machine has been purchased. This machine is regularly equipped with a two-speed countershaft drive giving two cutting speeds and constant reverse.

The left side view of the machine shows the automatic limit stop for the elevating device which is an added feature to this machine. This consists of a vertical rod having two collars connected to the shifting levers of the company's standard elevating device. These levers operate the friction clutches at the top of the machine for raising and lowering the rail. A bracket is fastened on to the back of the cross rail through which this rod passes. The collars on the rods are set to a predetermined height and it will be seen that when the bracket on the rail comes in contact with the collars, the vertical rod is moved in either the upward or downward motion causing the levers on the elevating device to operate the friction clutches.

All gears are thoroughly covered for the safety of the operator.

MORRIS STANDARD ENGINE LATHE

The Morris Machine Tool Company, Cincinnati, Ohio, has recently put on the market an 18-in. engine lathe, an illustration of which appears below. This machine has a swing over the ways of 18 $\frac{7}{8}$ in. and over the carriage of 11 $\frac{1}{8}$ in. It is built with beds from 6 to 14 ft. long. The lathe fitted with an 8-ft. bed will handle work 4 ft. 2 $\frac{1}{2}$ in. long, the length handled by the other sizes being in proportion to the length of beds.

The headstock is strong and well braced. The spindle is of hammered high carbon crucible steel, with 1 $\frac{1}{2}$ -in. diameter hole, fitted with No. 5 Morse taper bushing and No. 4 Morse taper center. It is also threaded to receive a chuck. Either single or double back gearing can be provided. The

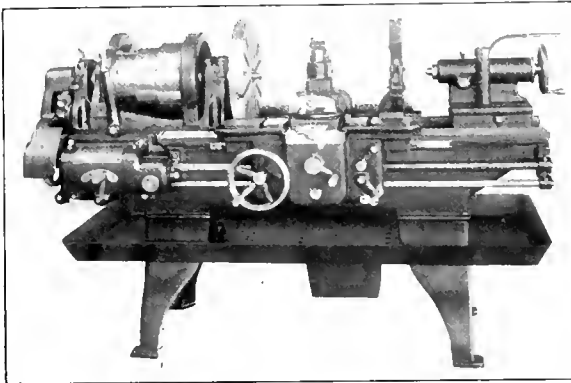

Morris 18-in. Engine Lathe

machines with single back gear are fitted with a four step cone pulley for 3 $\frac{1}{4}$ in. belt, while those with double back gears have a three step pulley for 3 $\frac{3}{4}$ -in. belt. The single back gear gives 16 speeds, ranging from 5 to 357 r.p.m., while the double back gears provide 18 speeds, from 13.5 to 346 r.p.m.

The carriage is of unusually heavy construction with bearings 30 $\frac{3}{4}$ in. long supported on large vees. The carriage is gibbed to the bed at both the front and back and is fitted to receive a taper attachment. The apron is of a patented one-piece box construction with all bearings cast integral. All gears are of steel and have bearings at both ends of the shafts. Each feed friction is operated by a single lever. An interlock makes it impossible to engage the thread and feed mechanisms at the same time. The standard feed box gives four changes of positive feed. With even gears on the stud and screw, these give 8, 16, 22 and 32 cuts per inch. With the regular equipment a range of threads from 2 to 30, including 11 $\frac{1}{2}$ threads per inch, can be cut. Provision is made for the use of change gears to cut special pitches or metric threads. A chasing dial is provided for catching threads. A compound rest with a swivel graduated in degrees and clamped by a single bolt is regularly furnished. The tool post will take 5 $\frac{1}{8}$ in. by 1 $\frac{1}{4}$ in. tools.

The tailstock is of a heavy box section with the bottom graduated and provided with set over screws. The spindle is of steel and it is clamped by split bushings operated by a single handle. The bed is 16 $\frac{1}{2}$ in. wide by 133 $\frac{3}{8}$ in. deep, braced with numerous cross girths. It is regularly supported by two legs, but with beds more than 10 ft. long a center leg is also provided.

The countershaft has double friction pulleys 14 in. in diameter for 4-in. belt. For the single back geared lathes the speed of the countershaft should be 120 and 160 r.p.m., while with double back gears it should be 205 and 245 r.p.m. The regular equipment of the lathe includes follow and

steady rests, two face plates, wrenches and the countershaft. If desired, extra furnishings including a plain rest, taper attachment, turret on shears, carriage, or tool post, a European tool post, pan and pump can be furnished.

ALL-GEARED DRILL AND TAPPER

The heavy duty all-gear'd drill and tapper shown in the illustration is manufactured by the Barnes Drill Company, Rockford, Ill. Every bearing in the machine, aside from the spindle sleeve and cross spindles, is self-oiled. There are eight changes of geared speeds and ten changes of geared feeds, all of which are under the immediate control of the operator from the front of the machine. All the gears of the machine are fully enclosed.

Oil is pumped by a geared pump in the reservoir of the machine and distributed to all the gears and bearings, including the crown gears and feed box. The transmission gears are cut from a high grade of chrome-nickel steel, being heat treated and tempered to prevent wear. The machine may be equipped with an automatic reversing mechanism manufactured by this company which can be set so that

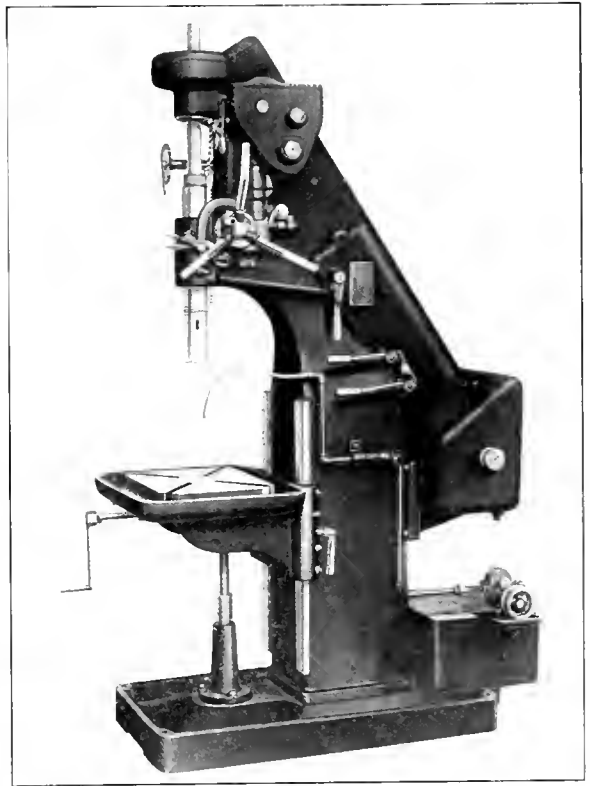

Barnes 22-in. All-Geared Drill and Tapper

the instant a tap reaches the required depth, the spindle will automatically reverse.

The machine is driven by a 10-h.p. motor for ordinary use, running at a speed of about 1,200 r.p.m. Speeds varying from 28 to 575 r.p.m. are obtained on this machine and the feed varies between .003 in. and .093 in. per revolution of the spindle. The machine will handle a 2-in. high speed drill in solid steel. The distance from the center of the spindle to the face of the column is 11 in. and the maximum distance from the regular table to the nose of the spindle is 32 in. The spindle has a travel of 14 in. and is equipped with either a No. 4 or No. 5 Morse taper, as pre-

ferred. The size of the regular table is 20 in. by 14 in. and has a vertical travel of 23 in. The floor space occupied by this machine is 52 in. by 31 in. It has a net weight of 2,540 lb. with the regular table and 3,200 lb. with the compound table, including the oil pump attachment.

BALL BEARING BENCH AND FLOOR GRINDERS

The bench and floor grinders and buffers shown in the illustrations are made by the Hisey-Wolf Machine Company, Cincinnati, Ohio. They are electrically driven machines, being self-contained in a compact unit. The spindles are made of high-grade steel, accurately ground. They run in S K F ball bearings, mounted in caps in close proximity to the grinding wheels, all the bearings being protected from dust and grit and provided with heavy felt protector washers on each side of the bearing housing. All the wheels are fitted on spindles of standard dimensions

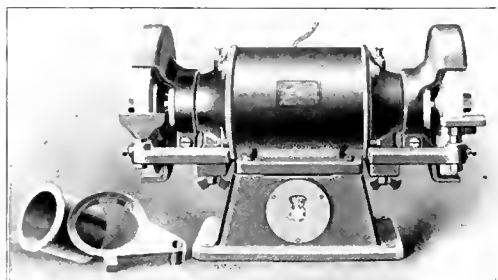

Bench Grinder and Buffer

recommended by the American Society of Mechanical Engineers. The flange washers are of ample size and carefully machined to provide the proper balance. The wheel guards are made of steel and enclose the grinding wheels for three-quarters of the circumference. Direct or alternating current motors are used to drive the machines. In both cases the motors are designed especially for this service, the

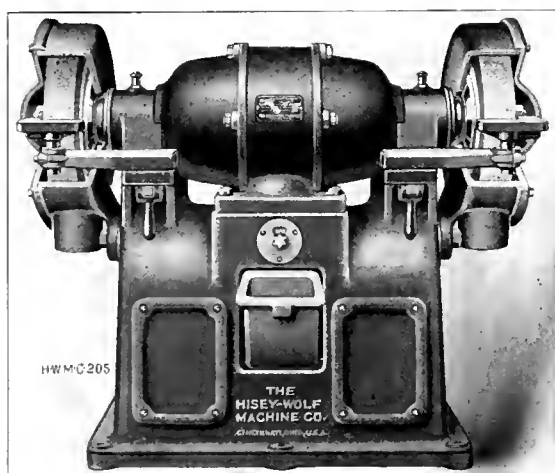

Floor Grinder and Buffer

direct current motors being compound wound and of the shunt type. They are designed to operate at uniform speeds and for continuous service within their capacity. The alternating current motors are of the squirrel cage induction type. The larger floor grinders have a wheel 18 in. in diameter

by 3 in. thick. They operate at speeds of 1,100 r.p.m. and are driven by 5-h.p. motors. The largest bench grinder has a wheel 14 in. in diameter by 2 in. wide, operates at a speed of 1,700 r.p.m. and is driven by a 3-h.p. motor. The smallest bench machine has an 8-in. wheel, $\frac{3}{4}$ in. thick and operates at 3,400 r.p.m., being driven by a $\frac{1}{2}$ -h.p. motor.

ARMSTRONG TOOL HOLDERS

The Armstrong Brothers Tool Company, Chicago, Ill., has lately developed two new tool holders, one for a light boring and threading tool and the other for an extension shaper tool. The boring tool holder which is shown in one

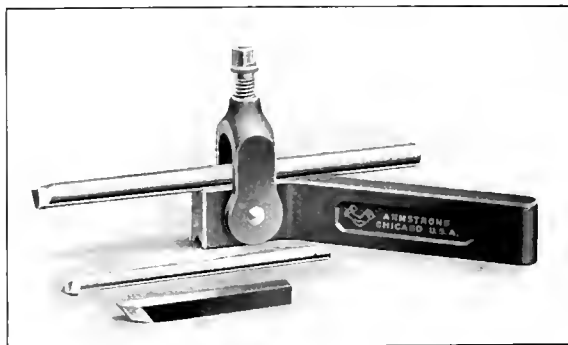

Light Boring Tool Holder

of the illustrations, is adaptable to tool room work or any boring work of small internal diameter. It can be used for threading, turning brass, etc. The holder is made reversible and can be used for turning either right or left hand. The size of the tool shank varies from $\frac{3}{8}$ in. by $\frac{3}{4}$ in. to $\frac{3}{4}$ in. by $1\frac{1}{2}$ in. The extension shaper tool holder forms a rigid sup-

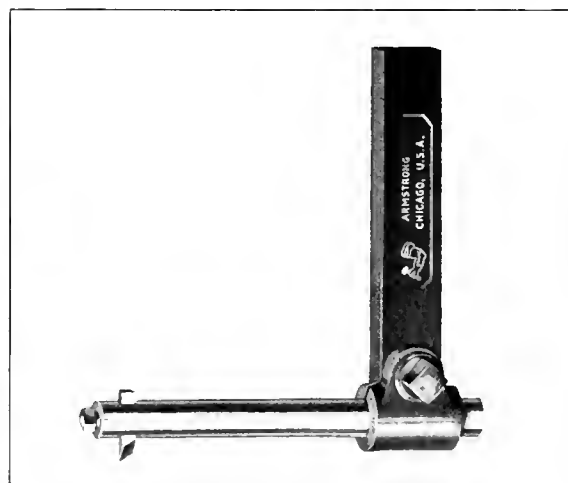

Extension Shaper Tool Holder

port for the cutting tool and can be used to good advantage in die work, cutting internal keyways or for any kind of work on a shaper in which extra clearance is needed. The size of the shank for this tool varies from $\frac{1}{2}$ in. by $1\frac{1}{8}$ in. to $\frac{3}{4}$ in. by $1\frac{5}{8}$ in.

MORE AMERICAN LOCOMOTIVES FOR CHINA.—Twenty more locomotives of American make have arrived in Wuchang for use on Chinese railways.

AMERICAN FLEXIBLE STAYBOLT

The American Flexible Staybolt Company, Pittsburgh, Pa., has revised its method of manufacture of its flexible staybolts to give greater resisting action to the stresses to which it is subjected in the locomotive firebox. The slot in the body of the staybolt is slotted as before, but the body slot has all edges and ends worked and rounded to eliminate all square or sharp edges. The fillets formerly used in joining the body to the threaded end have been changed to long tapers which give a better flow of the material from the end into the reduced diameter of the body. The entire forming of the body after slotting and working, including

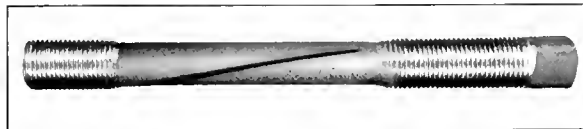

Latest Type of American Flexible Staybolt

the forming of the end tapers, is done by rolling, after which the bolt is twisted and straightened in a press, the square ends for application being formed at that time. All of the forging operations are completed in one heat and the bolts are piled while red hot, for slow cooling before machining.

Laboratory tests have shown that this method of making the bolts has produced a material improvement in their strength and flexibility. The ratio of yield point, or elastic limit to the tensile strength has been shown by tests to be .738, an increase of nine per cent over that generally obtained. The rolling process effects very little change in the original structure of the iron and the outer fibre stresses have been reduced to withstand a maximum lateral vibration.

VERTICAL SURFACE GRINDING MACHINE

The use of grinding machines is constantly finding wider application to locomotive work. There are a variety of uses to which they may be put and in some instances they have

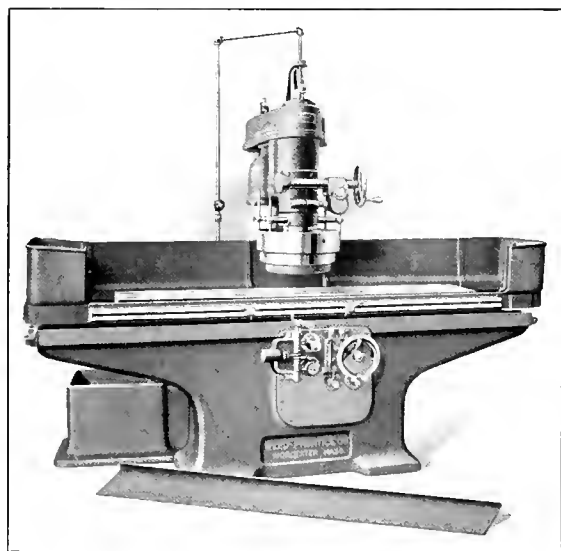

Reed-Prentice Vertical Grinding Machine

been found to decrease the cost of production and at the same time produce more accurate work. The vertical surface grinding machine shown in the illustration is made by the Reed-

Prentice Company, Worcester, Mass. This machine is designed for handling both surface and circular grinding. The head is of rigid construction, it being practically integral with the telescoping column back of the machine. The vertical adjustment of the head may be obtained by either hand or power feed, clamps being provided to hold the head in position after it has been raised to the proper height.

The bearing for the spindle is lined with nickel babbitt and it may be adjusted for wear. The spindle has a bearing of 3 in. in diameter for a length of 8 in. A sprocket and silent chain is used to drive the wheel spindle in preference to belt on account of the moisture and dirt. The spindle is made of alloy steel and is supported at the upper end in a ball bearing, the end play of the spindle being prevented by a heavy coil spring and two ball thrust collars. A

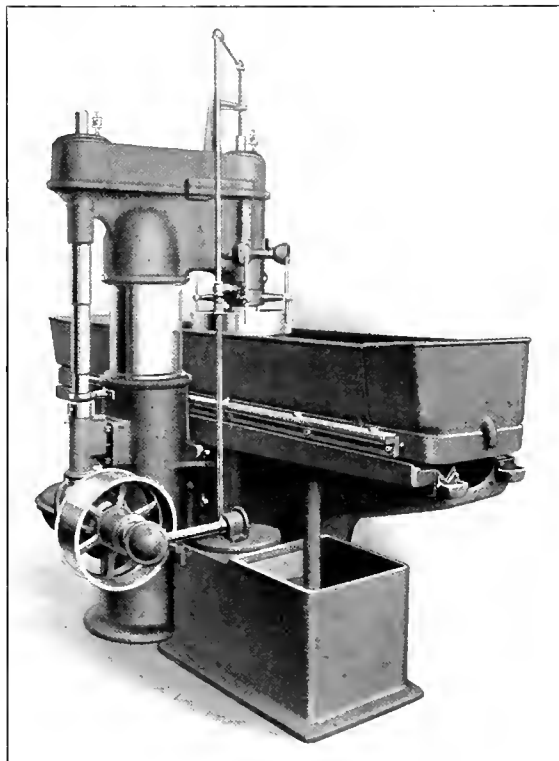

Back View of Reed-Prentice Vertical Surface Grinder

wheel chuck has been provided which will permit the wheels being changed quickly and at the same time hold them firmly. A vertical adjustment of the wheel in the chuck is provided so that the wheel may be used until it has been reduced to 1/2 in. or less in width without danger of crushing it. The wheel support is of a heavy goose-neck type, the telescoping part of which is supported in the bearings in the base.

The bed of the table is thoroughly braced and ribbed. It has large "V" and flat bearing surfaces. The table is also strongly braced to prevent warping. Six feeds are provided for the table, ranging from 2 ft. to 12 1/2 ft. per minute, or from .021 in. to .142 in. per revolution of the spindle. These feeds are controlled by levers at the front of the base and any feed may be obtained while the machine is in operation. The wheel feed is controlled by either hand or power, a counterbalance being provided. The power feed is provided with an automatic release. Twenty-five feeds may be obtained, ranging from .0002 in. to .005 in.

An ample supply of water is provided to both the inside

and the out-side of the wheel at the same time. The inside supply is furnished through the hollow spindle and the outside is furnished through the ordinary flush system. Rectangular or rotary magnetic chucks are provided with the table as desired. These chucks are waterproof and are well protected from short circuit.

The table has a working surface of 12 in. by 78 in. and a traverse of 78 in. The distance from the top of the table to the underside of the grinding wheel is 15 in. The wheels are 14 in. in diameter, 4 in. wide and have a rim of 1 1/4 in. The spindle speed is 1,050 r.p.m. The machine occupies a floor space of 5 ft. by 16 ft. 2 in. and has a net weight of 8,700 lb.

BACK GEARED CRANK SHAPER

The 24-in. back geared crank shaper shown in the illustration is made by the Queen City Machine Tool Company, Cincinnati, Ohio. This machine is equipped throughout with helical gears. This type of gear has been adopted by this company on account of the smooth finish of the work produced with them. It has found that they run practically noiseless and without backlash, and although they are cut on a comparatively small helix angle, 14 deg. 15 min., at least three teeth are in mesh at all times, which gives a continuous rolling motion to the ram. All the castings in these machines are either of cast steel or semi-steel. The crank pin and shaft journals are hardened and ground and the bearings are ring-oiled.

The length of the stroke of the ram can be quickly changed and positively locked while the ram is in motion or at rest.

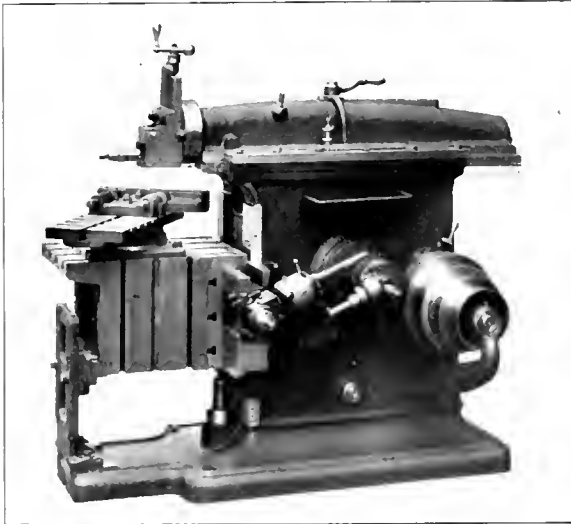

Queen City Back Geared Crank Shaper

All flat bearing surfaces are long and wide with provision for taking up the wear. The crank lug is hardened and ground. The body of the crank pin is a crucible steel casting. The machine is equipped with eight cutting speeds for every change of stroke, ranging in geometrical progression from 6.4 to 92 strokes per minute at 290 r.p.m. Sixteen changes of feed are provided. The table support moves up and down automatically with the rail and is self-aligning with the table. It is gibbed closely to the table, eliminating the spring due to both the thrust and lift of the tool when taking heavy cuts. It has a full vertical adjustment and ample bearing on the widest cross traverse. These shapers may be equipped with either an adjustable or constant speed motor.

VALVELESS BOILER SCALER

The George Oldham & Son Company, Frankford, Philadelphia, Pa., has recently placed on the market a valveless boiler scaler which is shown in the sketch. It is a compact little tool of simple construction. Its total weight is only 2 1/2 lb. and it is 5 in. long and 2 in. wide at the cap

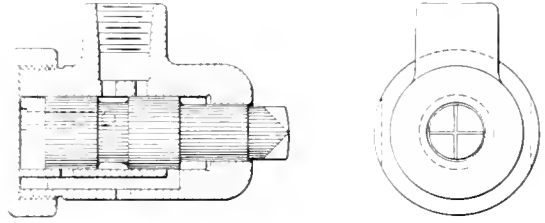

Valveless Boiler Scaler

and 1 1/2 in. wide at the nose end. The stroke is 7 3/8 in. and the bore of the cylinder is 11/16 in. The tool is small enough to get in at all points of a boiler and can be operated easily by air with an extension pipe.

FLUE RECLAIMING ATTACHMENT

The Draper Manufacturing Company, Port Huron, Mich., has recently developed the flue reclaiming attachment shown in the illustration. This device is used for welding split flues and for welding long sections of flues in connection with the pneumatic flue welding machine manufactured by this company. The welding machine is placed behind the furnace, with the end of a long mandrel central between the dies of the hammer and in line with the center

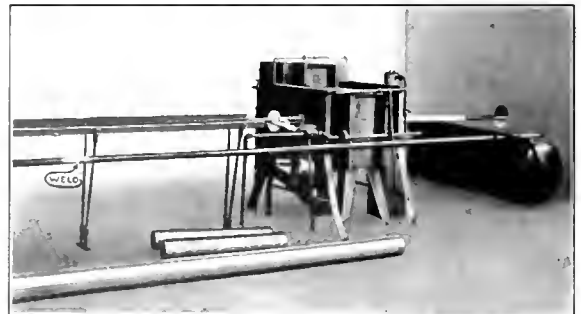

Draper Flue Reclaiming Attachment

of the furnace. A waterback is placed between the furnace and the welder, through which cold water is circulated to keep the welder cool. The flues to be welded are prepared in the ordinary way. The shorter piece is pushed through the furnace on to the mandrel and the other piece is inserted into or over the lap and the part to be welded is located in the center of the furnace. A clamp is then placed on the flue at a certain distance in front of the welding machine operating lever which is shown at the front of the furnace. The distance between this clamp and the center of the furnace is the same as that between the center of the welder and the operating lever. When the tubes have been raised to a welding heat, they are pushed through on the mandrel under the welding machine. The clamp on the tube will engage the operating lever when the weld is under the hammer of the welding machine, immediately putting the welding machine into operation. In this way, the joint is welded in a very few seconds after it leaves the fire. After the flue has been welded, the clamp is removed and the flue is taken

out and placed on a tilting table, where it is straightened. The tube is then allowed to cool until it will support its own overhanging weight. The only limit to the length of the flue that can be welded is dependent entirely upon the length of the mandrel behind the flue welder. The lengths of flues shown in the illustration are 12 ft. and 14 ft. respectively.

QUICK RELEASING FACE MILLING CUTTER

An inserted tooth face milling cutter which combines quick release and interchangeability with heavy service is manufactured by the Brown & Sharpe Manufacturing Company, Providence, R. I.

Trouble has been experienced at one time or another by machinists in removing the ordinary face milling cutter after it has become heated and "frozen" on the spindle. The

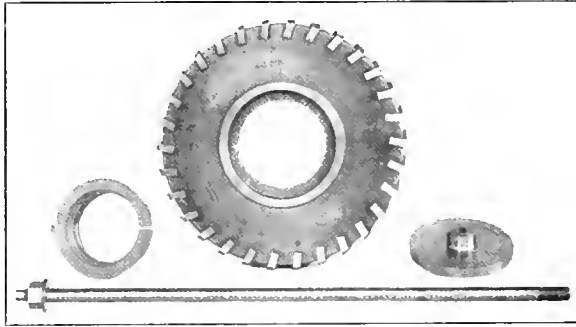

Fig. 1—Brown & Sharpe Quick Releasing Face Milling Cutter

force necessary to get such a cutter off is liable to result in damage to the cutter or may be sufficient to throw the spindle bearings out of alignment. Fig. 1 illustrates a cutter designed to overcome these difficulties, and the sectional diagram, Fig. 2, will show how readily this is accomplished.

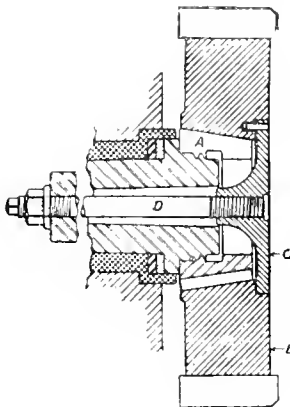

Fig. 2—Section Through Quick Releasing Face Milling Cutter

The split sleeve A which has a steep outside taper, screws on the nose of the machine spindle, the cutter B with a tapered hole is drawn tightly on this sleeve by the clamping plate C, and draw-in bolt D. A key in the sleeve fits into the cutter, thus insuring a positive drive.

When the draw-in bolt is loosened, the clamping plate is released, and the steep taper allows the cutter to be slid off instantly. As the taper is removed, the split sleeve expands and may be unscrewed from the spindle nose very easily. Split sleeves of varying sizes are made to fit different sizes

of spindles, thus one cutter may be interchanged from machine to machine, thereby eliminating the necessity of having a set of cutters to fit each machine spindle.

The cutters are held up close to the spindle as there are no long hubs projecting, thus the maximum working space is obtained.

Fig. 3 illustrates the rigid and efficient method used for holding the teeth in the periphery of the machinery steel

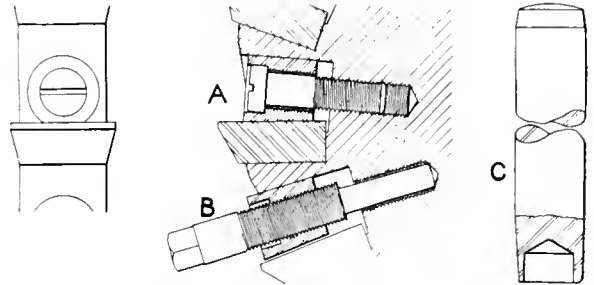

Fig. 3—Method of Holding the Teeth in B. & S. Inserted Tooth Cutters.

body on Brown & Sharpe inserted tooth cutters. When the teeth are inserted, the tapered bushing is driven in place by set C, and the screw is then put in, thus firmly securing the bushing. The bushings are removed with the extracting screw B.

TYPE "C" DUMORE GRINDER

At the request of a manufacturer who had found difficulty in securing dies on account of the present market conditions the Wisconsin Electric Company, Racine, Wis., made a special grinding machine, which enabled solid dies, round split dies, etc., to be sharpened. The first machine effected such a large saving that the tool has now been added to the company's line of electrical specialties as a special type of the regular Dumore grinder.

The attachment for sharpening solid dies consists of a carborundum pencil, 3/8 in. in diameter, held in a special

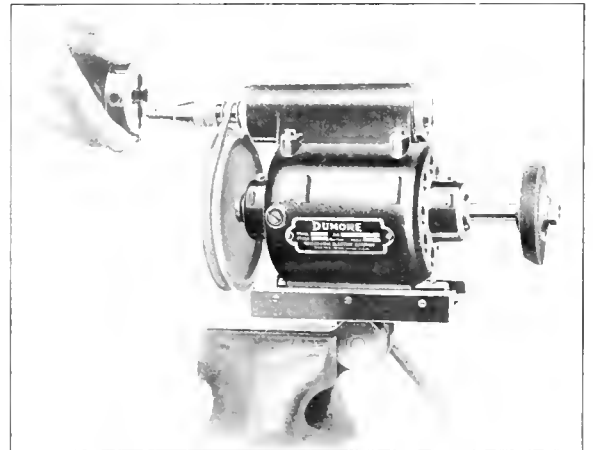

Type C Dumore Grinder

chuck mounted on a spindle which runs at the rate of 50,000 r.p.m. In sharpening dies the pencil is passed through the holes, as shown in the illustration. The teeth of the dies can thus be ground at the proper angle for the most effective work. Pencils dressed to any shape or size desired can be mounted in the chuck. This makes the machine useful

for lapping out blanking dies and for other similar work. Besides the small pencil there is a grinding wheel mounted on the motor spindle, which runs at a speed of 10,000 r.p.m. At shops where the Dumore grinder is already in use the special equipment for grinding dies can be purchased separately and attached to the motor as desired. The device has effected large economies, one manufacturer reporting a saving of from \$130 to \$200 a month by its use.

A HANDY PIPE VICE

The Whittington-Vaughn Company, Lanesboro, Pa., has recently developed a convenient pipe wrench which weighs less than 4 lb. and will handle a 2-in. pipe. This wrench may be applied at any convenient place by screws or bolts,

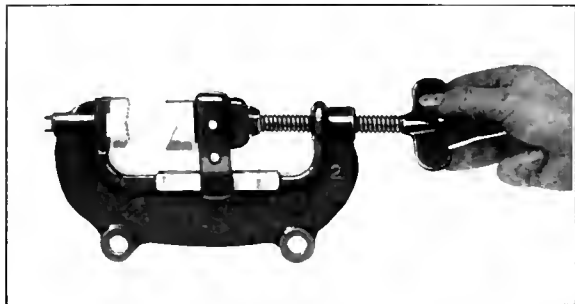

Whittington Pipe Vice

is easily carried in any kit of tools and is of strong construction. The floating jaw is guided on the body of the vice, giving a substantial support to it.

FLEXIBLE PIPE CONNECTION

A flexible pipe connection, consisting of a ball joint packed with $\frac{1}{4}$ -in. braided asbestos, has recently been placed on the market by the Franklin Railway Supply Company, 30 Church St., New York City. It is of simple construction, as shown

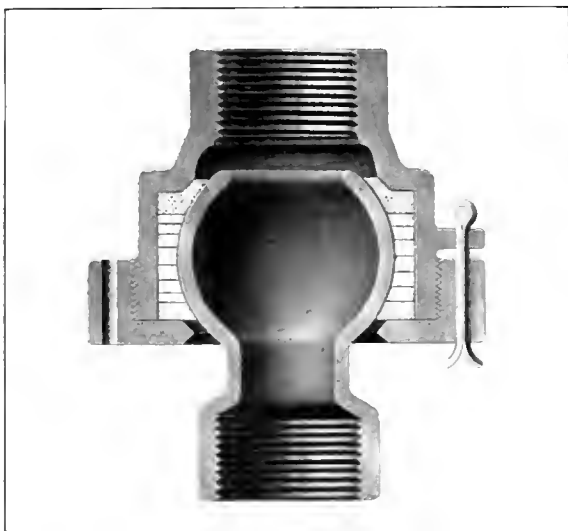

Flexible Pipe Ball Joint

by the illustration. Either the standard square or round asbestos packing may be used to pack the joint. This is of considerable advantage in that no special gaskets are required and the joint can be repacked at any shop or enginehouse.

By tightening the packing nuts, the packing is squeezed into place, completely filling the space between the metal rings. The packing nut is prevented from working loose by a cotter pin which extends through a hole in a lug on the body of the joint and a hole on the packing nut.

These flexible joints can be used for both steam and air and with standard piping will replace rubber hose in many places. They are especially adapted for use in roundhouse blower and blow-off lines, terminal coach heating lines, pump testing racks, etc. They can be used also to advantage in the main reservoir connections on locomotives, where flexibility is a desirable feature, and thereby eliminate pipe failures caused by a rigid union joint. The joints are made for either straight or angle connections.

AUTOMATIC METAL CUTTING-OFF MACHINES

The Nutter & Barnes Company, Hinsdale, N. H., has recently improved its cutting-off machines by the addition of a new method of lubrication which provides a heavy stream of lubricant at the cutting edge of the saws. The lubricant is contained in a well in the base of the machine and is pumped from there to a duct which is a part of the saw hood, as shown in the illustration. The supply of lubricant is controlled by the valve at the left of the hood. A flexible

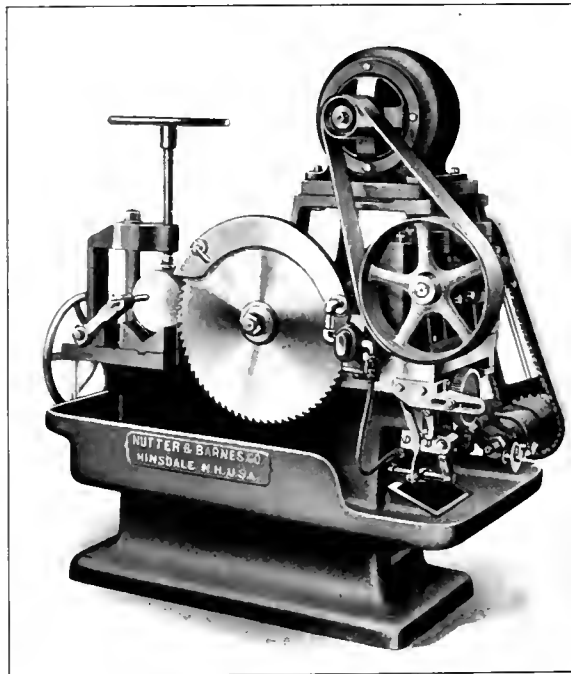

Automatic Cutting-Off Machine

pipe connects the reservoir at the bottom of the machine with the pump.

The motor for driving this machine is mounted directly on the movable slide of the machine. This arrangement is compact and the motor is up off the floor, out of the way of dirt and possible injury. This machine has a work table 14 in. by 25 in. by 29 in. high. The distance between the clamped yoke and the table is 10 $\frac{3}{4}$ in. The saw carriage is 25 in. long by 17 in. wide and is equipped with both power and hand feed. The machine is driven by a 3-h.p. motor, has a floor space of 3 ft. by 5 ft. 6 in. and a net weight of 2,800 lb.

LOCOLIGHT HEADLIGHT EQUIPMENT

The Locolight Company, Indianapolis, Ind., has recently brought out a new model of the standard generator which the company has been manufacturing since 1914. The new machine, which is rated to deliver 450 watts at 32 volts, embodies all the principal features used in the former type.

The turbo-generator, complete with the base, weighs 109 lb. The length over all is 18½ in., the height 15½ in. and the width 15 in. The turbine wheel is 11 in. in diameter, weighs

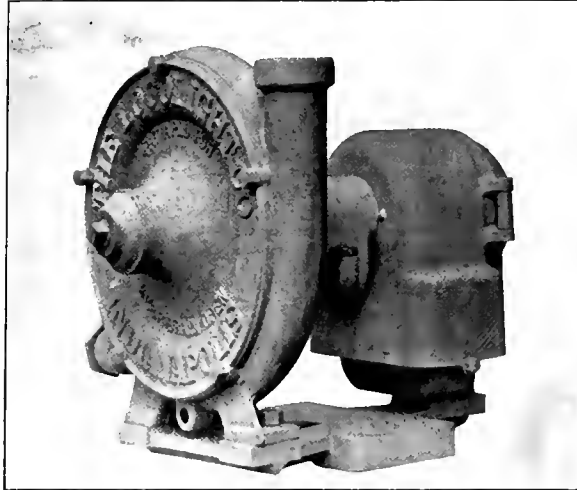

Locolight Headlight Generator

about 6 lb., and is designed to run at a speed of 3,200 r.p.m. The governor acts directly on the wheel, the governor weights in action forcing the wheel out of the path of the steam, thus controlling the speed. The shaft, wheel and governor can be removed from the machine without destroying the adjustment of the governor. The shaft is carried on two sets of annular ball-bearings which are lubricated by a chain oiling device. The chain passes over a spacer, between the ball bearings, which is smaller at the center than it is at either

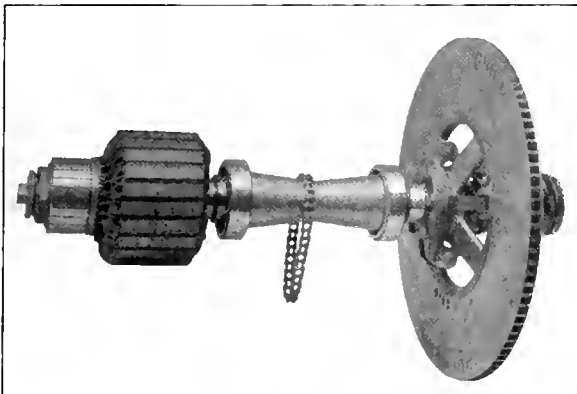

Rotating Parts and Bearings Assembled

of the ends. The ends of the spacer project into the ball bearing races. The oil which is brought up by the chain is carried by centrifugal force to the ends of the spacer and flies off into the bearings. Spacers at each end of the bearing housing throw off any oil which passes through the bearings and it is carried back to the oil well.

The dynamo is of the Edison bipolar type, compound

wound. The field frame is of electric malleable iron with pole pieces and frame in one piece, thus eliminating all joints in the magnetic circuit. The field coils are held rigidly on the frame and are well insulated. The brush holders are of the box type.

The headlight, which is regularly furnished with this generator, is equipped with a 30-volt, 150 watt incandescent lamp, which will comply with the requirements of the locomotive inspection law. The steam consumption of the turbine is approximately 102 lb. of steam per hour at 150 lb. boiler pressure and 128 lb. per hour at 220 lb. pressure. It is claimed for this equipment that the maintenance cost and the consumption of steam and of oil are low and that the absence of grease cups and packing reduces materially the attention which is required at the engine terminals.

EXPANSION JOINT WITH A CROSSHEAD GUIDE

An expansion joint having a crosshead and guide, adapted to all service on high or low pressure water, oil, gas or steam lines, has been tested for several years and is now being manufactured and sold by the Ross Heater & Manufacturing Company, Buffalo, N. Y. It is claimed for this crosshead guided joint that the sleeve is held in perfect alignment and that the weight of the pipe line is relieved from the sleeve and packing, thus preventing excessive wear

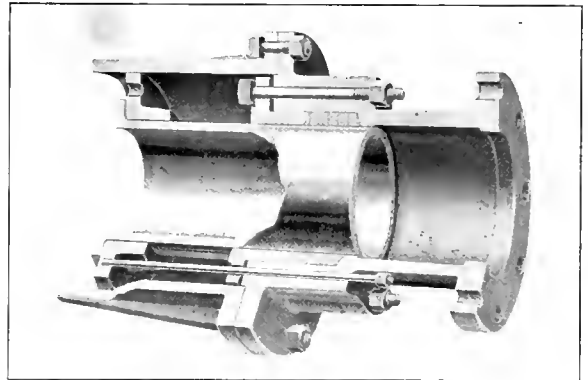

Ross Crosshead Guided Expansion Joint

on these parts. The main casting is divided in two parts, which are connected by a heavy flange and bolts. The moving elements consist of a long sleeve made steam-tight by a stuffing box and gland. The sleeve is supported at the outer end by companion flanges, which are machined on the outer surfaces and slide in the guide, the internal surface of which is also machined. Stops are provided on the guide to prevent the crosshead being drawn out of the casing and thus breaking the joint.

All the parts are substantially constructed and are readily accessible by removing the casing. The packing space of the stuffing box is long and is adapted to the use of any kind of metallic or fibrous packing. The sleeve is made of bronze and for pressures up to 150 lb. all other parts are made of semi-steel; for higher pressures cast steel is used. The sleeves are made in two types, one having a free travel of 4 in. and the other of 8 in. These types are made in both single and double joints providing an exceptional range of movement. This joint occupies little space and is easily insulated. It has been used successfully on steam lines carrying a pressure of 175 lb. the steam being superheated to 300 deg. F.

Railway Mechanical Engineer

(Formerly the RAILWAY AGE GAZETTE, MECHANICAL EDITION
with which the AMERICAN ENGINEER was incorporated)

PUBLISHED ON THE FIRST THURSDAY OF EVERY MONTH BY THE
SIMMONS BOARDMAN PUBLISHING COMPANY

EDWARD A. SIMMONS, *President* L. B. SHIERMAN, *Vice-President*
HENRY LEE, *Vice-President and Treasurer* M. H. WILM, *Secretary*
WOODWORTH BUILDING, NEW YORK, N. Y.
F. H. THOMSON, *Business Manager*, CHICAGO.

Chicago: Transportation Bldg. Cleveland: Citizens' Bldg.
Washington: Home Life Bldg.
London: Queen Anne's Chambers, Westminster.

ROY V. WRIGHT, *Editor*
R. E. THAYER, *Managing Editor*
C. E. PECK, *Associate Editor* A. F. STUBING, *Associate Editor*

Entered at the Post Office at New York, N. Y., as mail matter of the
second class.

Subscriptions, including the eight daily editions of the *Railway Age Gazette* published in June in connection with the annual conventions of the Master Car Builders' and American Railway Master Mechanics' Associations, payable in advance and postage free: United States, Canada and Mexico, \$2.00 a year; Foreign Countries (excepting daily editions), \$3.00 a year; Single Copy, 25 cents.

WE GUARANTEE, that of this issue 9,750 copies were printed; that of these 9,750 copies 7,885 were mailed to regular paid subscribers, 112 were provided for counter and news companies' sales, 283 were mailed to advertisers, 166 were mailed to exchanges and correspondents, and 1,304 were provided for new subscriptions, samples, copies lost in the mail and office use; that the total copies printed this year to date were 54,647, an average of 9,107 copies a month.

The RAILWAY MECHANICAL ENGINEER is a member of the Associated Business Papers (A. B. P.) and the Audit Bureau of Circulations (A. B. C.).

The Atchison, Topeka & Santa Fe reports that 263 of its employees from all branches of railway service have already enlisted in the regular army, the national guard, the navy, the marines and the signal, aviation, engineer, and reserve corps.

The Chicago, Burlington & Quincy has granted a 10 per cent increase in pay to all shop men and "unorganized" employees on the road. The increase for the shop and clerical men took effect on May 16, and the track laborers' advance dates back to April 18.

The Interstate Commerce Commission, by an order dated April 12, has extended for eight months from July 1, 1917, the time within which freight cars must be equipped with safety appliances to conform to the standards prescribed by the commission, as set forth in its orders of March 13, 1911, and November 2, 1915.

President H. U. Mudge, of the Denver & Rio Grande, announces that beginning July 1 the company will retire all employees at the age of 70 and will pay pensions to retired employees according to the usual custom on many roads. The pension will be extended to all persons continuously in the employ of the company 25 years and includes both officers and employees. The basis of the pension will be the average monthly pay for the ten years previous to retirement. Of this average pay each employee retired will receive one per cent for each year in the service.

The Texas & Pacific has issued a notice to all of its section and machine shop foremen that they should place in immediate cultivation all the available space along the right of way. In order to provide an adequate supply of labor each section man and machine shop employee is to be given one-half day a week of the company's time to perform this work. The employees will share in the crops thus grown, according to the number of hours the man works, including the one-half day of the company's time allowed, and the extra time that he may put in. Particular attention is to be given to the growing of vegetables, such as tomatoes, cabbage, beans, radishes, potatoes and roasting ears. The planting of cotton is prohibited.

J. M. Hannaford, president of the Northern Pacific, has issued a statement authorizing bonuses for "unorganized" employees, which will aggregate about \$750,000. This increase in compensation follows an advance of five per cent made last October, the difference being that the bonus now

announced takes in employees whose salaries run up to \$3,000 a year, whereas the increase granted last October applied only to those whose salaries were below \$2,000. The statement sets forth that in view of the continued increase in the cost of living, employees in service on July 1, 1917, will be granted a bonus of 10 per cent of their wages between January 1 and July 1, except where service has not been continuous and where the wages of employees are fixed by contracts or schedules made by collective agreement. It is further stated that similar bonus payments will be considered from time to time, as conditions warrant.

Preliminary steps for the electrification of the Chicago, Milwaukee & St. Paul from Othello, Wash., to Seattle and Tacoma, are now being taken and construction work will soon be under way. Electric power has been contracted for with the Intermountain Electric Power Company, and substations are to be built at Taunton, Wash.; Doris, Kittitas, Cle Elum, Hyak, Cedar Falls, Renton and Tacoma. These eight stations will be of the same in-door type as was adopted in the recently completed installation between Avery, Idaho, and Harlowton, Mont. The stations will each contain two 2,000 kw. units, and specifications for all the station machinery and locomotives are now in the hands of builders for bids. The poles for the proposed electrified zone have already been bought and are now being delivered. The actual setting of the poles will commence within 30 days. It is expected that the contemplated 225 miles to be electrified from Othello, Wash., to Seattle and Tacoma, will be completed by January 1, 1919, and that the first unit, that between Othello and Cle Elum, will be ready for operation on January 1, 1918.

COMMITTEES TO INVESTIGATE CAR AND LOCOMOTIVE BUILDING CAPACITY

Committees of car and locomotive builders have been organized at the request of the Council of National Defense to investigate the capacity of car and locomotive building plants in this country and the extent of their ability to turn out additional motive power and equipment for the railroads of this country and for the Allies. The membership of these committees is as follows: Car Committee: S. M. Vauchain, vice-president of Baldwin Locomotive Works, chairman; E. F. Carry, president of Haskell & Barker Car Company; Charles S. Gawthrop, vice-president of the American Car & Foundry Company; Clive Runnels, vice-president of the

Pullman Company; R. L. Gordon, vice-president of the Standard Steel Car Company, and A. S. Reeder, vice-president of the Pressed Steel Car Company. Locomotive Committee: S. M. Vauclain, chairman; Andrew Fletcher, president of the American Locomotive Company; H. P. Ayres, vice-president of H. K. Porter Locomotive Company, and Joel Coffin, chairman of Lima Locomotive Corporation.

WOMEN EMPLOYEES IN THE MECHANICAL DEPARTMENT

Following a conference several weeks ago between J. M. Davis, vice-president of operation and maintenance, and officers of his staff, the Baltimore & Ohio announced that positions in its shops, in the freight and passenger terminals and other outside places were open to women. Immediately several applications were accepted. At Lorain, Ohio, where the company handles its largest lake coal and ore traffic,

various tasks in the machine and air brake shops. Women have been found to be well adapted to sorting the smaller and lighter classes of scrap material at the Painesville, Ohio, scrap reclamation plant. Women are being paid the same wages as would be paid to men doing the same work.

On the Pennsylvania Railroad every general superintendent has been directed by the general manager, Elisha Lee, to investigate and report, as promptly as possible, in what capacities girls or women can be employed efficiently on all parts of the railroad; what numbers can be so utilized, and to what extent they can perform the work now being done by men. The object of this step is twofold: First, to release men from work that can as well be performed by women, and thus increase the number of male employees available for those forms of railroad service for which women are not so well adapted; second, to prepare for the probability that selective conscription will ultimately result in a considerable depletion of the forces of male employees not actually en-



Women Employed in the Baltimore & Ohio Shops at Lorain, Ohio

women were given positions in the shops as helpers and at various kinds of light labor. A group of these women shop employees are shown in the photograph which is reproduced herewith.

The four women shown with overalls are all employed in the shops. The others, from left to right, are employed as oil distributor, blacksmith helper, yard cleaner, car clerk and a-sorter of small scrap materials. At the time this is written 29 women in all are employed at the Lorain shops. These include 11 laborers and one leading laborer, three car oilers, two blacksmith helpers, two mill laborers, one oil distributor, one janitress, one time checker, one car clerk, one car preparer and five others who are employed at

gaged in the physical operation of the railroad. No men will be dropped from the payrolls to make way for women, although some may be called upon to change the form of their occupation.

Stenography, typewriting and practically all other kinds of clerical work will be open to women at once. This will apply not only at the general offices in Philadelphia, but also at all other offices where large clerical forces are employed, including agencies, freight stations and transfers.

The investigation to be conducted by the general superintendents will also be directed to ascertaining whether or not girls and women may be advantageously employed in other positions, including the lighter forms of machine shop work.

telegraphy, telephony, signaling, ticket selling and car cleaning.

Car and Locomotive Orders in May

As noted elsewhere in this issue the distinguishing feature in the equipment market at present is the continued heavy buying of locomotives. The orders in May were extremely heavy from the standpoint of both domestic and foreign business. The totals for the month were as follows:

	Locomotives	Freight cars	Passenger cars
Domestic	653	4,248	73
Foreign	640	10,000	--
	1,293	14,248	73

Among the important locomotive orders were the following:

Chicago, Burlington & Quincy.....	45 Mikado	Baldwin
	10 Pacific	Baldwin
	10 Santa Fe	Baldwin
Great Northern	40 Switching	Baldwin
	80 Mikado	Baldwin
Northern Pacific	40 Mikado	American
Pennsylvania	35 Switching	} 245 Altoona and 30 Baldwin
	81 Passenger	
	129 Mikado	
	23 Decapod	
Pennsylvania Lines West.....	35 Santa Fe	American
	10 Mallet	Baldwin
	25 Santa Fe	Baldwin
	40 Passenger	Altoona
Philadelphia & Reading.....	20 Mallet	Baldwin
British War Office.....	50 0-6-0	Baldwin
Paris-Orleans.....	50 Mikado	American
Russian Government	250 Decapod	American
	250 Decapod	Baldwin

The freight car orders included the following:

Atchison, Topeka & Santa Fe.....	1,000 Gondola.....	Am. C. & F.
Canadian Government	1,000 Box.....	Can. C. & F.
	1,000 Box.....	Eastern
Illinois Central	500 Refrigerator.....	Has. & Bar.
Russian Government	6,500 Box.....	Am. C. & F.
	3,500 Box.....	Std. Steel

The Illinois Central's passenger car order accounted for 71 of the 73 passenger cars reported during the month.

MEETINGS AND CONVENTIONS

Master Tinnners', Coppersmiths' and Pipefitters' Association.—The annual convention of the American Railroad Master Tinnners', Coppersmiths' and Pipefitters' Association for 1917 has been postponed.

American Gear Manufacturers' Association.—The recently organized American Gear Manufacturers' Association held its first convention at the Hotel Schenley, Pittsburgh, Pa., on May 14 and 15. This association has been organized for the purpose of developing, standardizing and improving all products of the gear industry.

Master Boiler Makers' Association.—At a meeting of the executive board in Chicago on Wednesday, May 2, it was decided, on account of war conditions, to postpone indefinitely the eleventh annual convention of the Master Boiler Makers' Association, which was to have been held May 22 to 25 at the Jefferson Hotel, Richmond, Va.

Chief Interchange Car Inspectors' and Car Foremen's Association.—The annual convention of the Chief Interchange Car Inspectors' and Car Foremen's Association which was scheduled to be held at St. Louis, Mo., from September 25 to 27, inclusive, has been postponed for one year. The present officers will retain their positions until their successors are duly elected.

Railway Storekeepers' Association.—The annual convention of the Railway Storekeepers' Association, which was to have been held at Chicago, May 21 to 23, has been postponed. In his statement announcing this postponement, President W. A. Summerhays calls attention to the difficulty of securing material at present, and to the importance of storekeepers remaining on their roads to insure that material essential to operation may be available.

Western Railway Club.—At the annual meeting of the Western Railway Club, held on May 21 at the Hotel Sherman, Chicago, the following officers were elected: President, A. R. Kipp, mechanical superintendent Chicago division, Soo Line; first vice-president, A. LaMar, master mechanic, Pennsylvania Lines; second vice-president, G. S. Goodwin, mechanical engineer, Chicago, Rock Island & Pacific; secretary and treasurer, Joseph W. Taylor.

General Foremen's Association.—The executive committee of the International Railway General Foremen's Association has decided that the 1917 convention of that association be canceled. The advance papers will be distributed, however, and the members are requested to send written discussions to the secretary on or before September 15, 1917. These will be incorporated in the regular proceedings, which will be published as heretofore.

Master Mechanics' and Master Car Builders' Association.—At a joint meeting of the executive committees of the American Railway Master Mechanics' Association and the Master Car Builders' Association, held at Chicago on April 30, it was decided not to hold the annual conventions which were to have taken place at Atlantic City, N. J., in June. It was the opinion of the committees that during the war emergency it was imperative for all railway employes to remain at their posts ready to give their best services to their roads and the government.

American Society for Testing Materials.—The twentieth annual meeting of the American Society for Testing Materials will be held at Atlantic City, June 26 to 29, with headquarters at the Hotel Traymore. At the second session on Tuesday afternoon, June 26, a paper will be read by A. T. Goldbeck on "Distribution of Pressure Through Earth Fills."

The other sessions are as follows:

- Third session, Tuesday evening, annual address by the president.
- Fourth session, Wednesday morning, On Iron and Steel.
- Fifth session, Wednesday evening, On Non-Ferrous Metals.
- Sixth session, Thursday morning, On Preservative Coatings and Miscellaneous materials.
- Seventh session, Thursday evening, On Cement and Concrete.
- Eighth session, Friday morning, On Concrete and Lime.
- Ninth session, Friday afternoon, On Ceramics.
- Tenth session, Friday evening, On Miscellaneous Materials. Committee reports will be presented at this session on Fireproofing, I. H. Woolson, chairman; on Waterproofing, W. A. Aiken, chairman; on Timber, Herman von Schrenk, chairman; Shipping Containers, E. W. Dunn, chairman, etc.

The following list gives names of secretaries, dates of next or regular meetings and places of meeting of mechanical associations:

- AIR BRAKE ASSOCIATION.—F. M. Nellis, Room 3014, 165 Broadway, New York City.
- AMERICAN RAILROAD MASTER TINNERS', COPPERSMITHS' AND PIPEFITTERS' ASSOCIATION.—O. E. Schlink, 485 W. Fifth St., Peru, Ind. Convention postponed.
- AMERICAN RAILWAY MASTER MECHANICS' ASSOCIATION.—J. W. Taylor, Karpen Building, Chicago. Convention postponed.
- AMERICAN RAILWAY TOOL FOREMEN'S ASSOCIATION.—R. D. Fletcher, Belt Railway, Chicago. Convention, August 30, 31 and September 1, 1917, Hotel Sherman, Chicago.
- AMERICAN SOCIETY FOR TESTING MATERIALS.—Prof. E. Marburg, University of Pennsylvania, Philadelphia Pa. Annual meeting June 26-29, Hotel Traymore, Atlantic City, N. J.
- AMERICAN SOCIETY OF MECHANICAL ENGINEERS.—Calvin W. Rice, 29 W. Thirty-ninth St., New York.
- ASSOCIATION OF RAILWAY ELECTRICAL ENGINEERS.—Joseph A. Andrucciotti, C. & N. W. Room 411, C. & N. Station, Chicago.
- CAR FOREMEN'S ASSOCIATION OF CHICAGO.—Anton Kline, 841 Lawlor Ave., Chicago. Second Monday in month, except June, July and August, Hotel La Salle, Chicago.
- CHIEF INTERCHANGE CAR INSPECTORS' AND CAR FOREMEN'S ASSOCIATION.—W. K. McMunn, New York Central, Albany, N. Y. Convention postponed.
- INTERNATIONAL RAILROAD MASTER BLACKSMITHS' ASSOCIATION.—A. L. Woodworth, C. H. & D. Lima, Ohio. Convention, August 21, 1917, Hotel Sherman, Chicago.
- INTERNATIONAL RAILWAY FUEL ASSOCIATION.—J. G. Crawford, 547 W. Jackson Blvd., Chicago.
- INTERNATIONAL RAILWAY GENERAL FOREMEN'S ASSOCIATION.—William Hall, 1126 W. Broadway, Winona, Minn. Convention postponed.
- MASTER BOILERMAKERS' ASSOCIATION.—Hatty P. Vought, 95 Liberty St., New York. Convention postponed.
- MASTER CAR BUILDERS' ASSOCIATION.—J. W. Taylor, Karpen Building, Chicago. Convention postponed.
- MASTER CAR AND LOCOMOTIVE PAINTERS' ASSOCIATION OF U. S. AND CANADA.—A. P. Dane, B. & M., Reading, Mass. Convention, September 11, 1917, Hotel La Salle, Chicago.
- NIAGARA FRONTIER CARBERS' ASSOCIATION.—E. N. Frankenhoefer, 623 Brisbane Building, Buffalo, N. Y. Meetings, third Wednesday in month, New York Telephone Bldg., Buffalo, N. Y.
- RAILWAY STOREKEEPERS' ASSOCIATION.—J. F. Murphy, Box C, Collinwood, Ohio. Convention postponed.
- TRAVELING ENGINEERS' ASSOCIATION.—W. O. Thompson, N. Y. C. R. R., Cleveland, Ohio.

PERSONAL MENTION

GENERAL

W. J. BENNETT, master mechanic of the Utah lines of the Denver & Rio Grande at Salt Lake City, Utah, has been appointed assistant superintendent of the motive power and car departments, with headquarters at Denver, Colo.

G. A. MORIARTY, general master mechanic of the New York, New Haven & Hartford, has been promoted to the newly created position of mechanical superintendent of the



G. A. Moriarty

lines east, with headquarters at Boston, Mass. Mr. Moriarty began railway work in 1887 as a machinist apprentice on the Baltimore & Ohio. He subsequently served on several different roads as machinist, and then returned to the service of the Baltimore & Ohio as machine shop foreman. He was later with the Erie, and served in different positions on the road. In 1907 he went to the New York, New Haven & Hartford as master mechanic, and in January,

1917, was appointed general master mechanic, which position he held at the time of his recent appointment as mechanical superintendent of the lines east.

J. L. CUNNINGHAM, master mechanic of the Philadelphia division of the Pennsylvania Railroad at Harrisburg, Pa., has been appointed superintendent of motive power of the



J. L. Cunningham

Western Pennsylvania division with office at Pittsburgh, Pa. Mr. Cunningham was born on September 28, 1874, at West Fairfield, Pa., and entered the service of the Pennsylvania Railroad on November 13, 1891, as an apprentice in the Altoona machine shop. He was made a machinist on February 1, 1896, and in August of that year resigned from the service. In June, 1900, he returned to the service of the Pennsylvania Railroad as machinist in the Altoona machine

shop, and the following month was transferred as inspector to the Philadelphia division. On March 1, 1901, he was transferred to the Pittsburgh division in the same capacity and in December, 1902, was made foreman on the Bedford division. One year later he was appointed assistant master mechanic on the Philadelphia division. In January, 1904, he became general foreman, and in August, 1906, was appointed assistant engineer of the Central divi-

sion. He was promoted to master mechanic of the Maryland division on July 1, 1913, and three years later was transferred to the Philadelphia division in the same capacity, which position he held at the time of his recent appointment.

BEN JOHNSON, locomotive superintendent of the United Railways of Havana, the Havana Central and the Western Railways of Havana at Cienaga, Havana, Cuba, resigned on May 1. Mr. Johnson is retiring from active business life.

ARTHUR KROHN has been appointed assistant superintendent of motive power of the Missouri, Kansas & Texas, with headquarters at Parsons, Kans.

A. N. LUCAS, general foreman of the locomotive department of the Chicago, Milwaukee & St. Paul at Milwaukee, Wis., has been appointed assistant superintendent of motive power with headquarters at Milwaukee.

H. H. MAXFIELD, superintendent of motive power of the Western Pennsylvania division of the Pennsylvania Railroad, has been appointed superintendent of motive

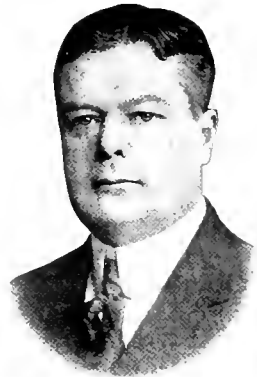

H. H. Maxfield

power of the New Jersey division with office at New York, succeeding D. M. Perine. Mr. Maxfield was born in 1873 and was educated at Stevens Institute. He entered the service of the Pennsylvania Railroad on September 5, 1885, as an apprentice in the Meadow shops and on August 1, 1899, he became machinist and in March, 1900, inspector and gang leader. He was promoted in December, 1902, to assistant master mechanic at the Pavonia shops of the

Trenton division and in April, 1903, was appointed assistant engineer of motive power of the New Jersey division at Jersey City. On April 1, 1905, he was appointed master mechanic of the Trenton division and in July, 1911, was transferred to the Pittsburgh division in the same capacity. On May 1, 1916, he was promoted to superintendent of motive power of the Western Pennsylvania division and now becomes superintendent of motive power of the New Jersey division.

JAMES MILLIKEN, superintendent of motive power of the Philadelphia, Baltimore & Washington at Wilmington, Del., has been promoted to special engineer in the office of the general superintendent of motive power of the Pennsylvania Railroad, lines east of Pittsburgh and Erie, with office at Altoona, Pa. Mr. Milliken was born on February 19, 1865, in Newtown, Bucks county, Pa. He was educated in the Philadelphia schools and also took a partial course at the University of Pennsylvania. On September 6, 1885, he entered the service of the Pennsylvania Railroad as a fireman on the Pittsburgh division and in March of the following year was transferred as an apprentice to the Altoona machine shop. After serving his apprenticeship he became assistant road foreman of engines on the Philadelphia and Pittsburgh divisions. In February, 1892, he was appointed assistant master mechanic at the Altoona machine shops; in 1895 he was appointed assistant engineer of motive power of the Philadelphia, Baltimore & Washington, and later served in a like capacity on the New Jersey division. He was appointed master mechanic at the Mount Vernon shops,

Baltimore, Md., in August, 1900, and was promoted to superintendent of motive power of the Philadelphia, Baltimore & Washington in January, 1903.

C. D. YOUNG, engineer of tests of the Pennsylvania Railroad at Altoona, has been appointed superintendent of motive power of the Philadelphia, Baltimore & Washington, with headquarters at Wilmington, Del., succeeding James Milliken. Mr. Young was born on May 19, 1878, at Washington, D. C., and on June 25, 1900, entered the service of the Pittsburgh, Cincinnati, Chicago & St. Louis as a special apprentice. In July, 1903, he was promoted to erecting gang foreman, and on October 10, 1903, he became machine foreman. He was promoted to assistant motive power inspector on January 1, 1905, serving in that capacity until May 1, 1906, when he was transferred to the Pittsburgh, Fort Wayne & Chicago as assistant master mechanic. In September, 1906, he returned to the Pittsburgh, Cincinnati, Chicago & St. Louis as assistant engineer of motive power, and on June 1, 1910, assumed that office under the general superintendent of motive power of the Pennsylvania Lines West of Pittsburgh. On October 1, 1911, he became engineer of tests on the staff of the general superintendent of motive power of the lines east.



C. D. Young

DAVID M. PERINE, superintendent of motive power of the Pennsylvania Railroad at New York, has been promoted to the personal staff of the general superintendent of the New Jersey division, with office at New York. Mr. Perine was born February 13, 1869, at Baltimore, Md., and was educated in the schools of his native town. He also took a full course in mechanical drawing and designing at the Maryland Institute. On May 14, 1888, he entered the service of the Pennsylvania Railroad as an apprentice at the Mount Vernon shops of the Northern Central, and completed his apprenticeship at the Altoona shops. In April, 1894, he was appointed assistant road foreman of engines on the Pittsburgh division, and on August 1, 1895, was promoted to assistant master mechanic of the Altoona machine shops. In March, 1899, he was appointed assistant engineer of motive power of the Northern Central and the Philadelphia & Erie, and in March, 1900, was transferred to Altoona as assistant engineer of motive power. He was promoted to master mechanic of the Pittsburgh division on October 1, 1901, and on August 1, 1903, was transferred to West Philadelphia as master mechanic of the West Phila-



D. M. Perine

delphia shops. On April 1, 1906, he was promoted to superintendent of motive power of the Northern Central and the Philadelphia & Erie, and on April 1, 1907, was transferred to Pittsburgh as superintendent of motive power of the Western Pennsylvania division. On January 1, 1912, he was transferred to New York as superintendent of motive power of the New Jersey Division, and the West Jersey & Seashore, which position he held until his recent promotion.

C. J. STEWART, who has been appointed to the recently created position of mechanical superintendent of the New York, New Haven & Hartford, lines west, with headquarters at New Haven, Conn., began railway work with the Erie as a caller. He subsequently served consecutively as engine despatcher, special apprentice, fireman, engine inspector and foreman on the same road. He then entered the service of the Delaware, Lackawanna & Western as machinist, and later served as foreman and general foreman until 1905, when he went to the Central New England as master mechanic. In 1913 he was appointed assistant mechanical superintendent of the New York, New Haven & Hartford, at New Haven, Conn., which position he held at the time of his recent appointment as mechanical superintendent.



C. J. Stewart

MASTER MECHANICS AND ROAD FOREMEN OF ENGINES

A. L. BROWN has been appointed master mechanic of the Baltimore & Ohio at Glenwood, Pittsburgh, Pa., succeeding F. P. Pfahler.

THOMAS C. DONALDSON has been appointed master mechanic of the Rochester and Buffalo division of the Buffalo, Rochester & Pittsburgh, with headquarters at Salamanca, N. Y.

T. HAMBLY has been appointed acting master mechanic of the Canadian Pacific, Algoma district, with headquarters at North Bay, Ont., succeeding J. H. Mills, resigned.

E. J. HARRIS, superintendent of shops of the Denver & Rio Grande, at Salt Lake City, has been appointed master mechanic of the Utah lines, with headquarters at Salt Lake City, succeeding W. J. Bennett.

O. E. MAXWELL has been appointed road foreman of engines of the Pennsylvania Lines at Ft. Wayne, Ind., succeeding J. H. Hanna, transferred.

W. G. MCPHERSON, general roundhouse foreman of the Canadian Pacific at Moose Jaw, Sask., has been appointed division master mechanic at Regina, Sask., succeeding S. W. Falkins, transferred.

DWIGHT C. MORGAN, JR., has been appointed mechanical engineer of the Pittsburgh & Shawmut, with headquarters at Brookville, Pa.

WILLIAM E. O'BRIEN has been appointed road foreman of engines of the Buffalo, Rochester & Pittsburgh, with headquarters at Rochester, N. Y.

F. P. PFAHLER, master mechanic of the Baltimore & Ohio at Glenwood, Pittsburgh, Pa., has been appointed master mechanic at Cumberland, Md., succeeding R. B. Stout.

G. A. SCHMOLL, general master mechanic of the Baltimore & Ohio at Pittsburgh, Pa., has been granted leave of absence on account of ill-health.

W. WELLS has been appointed division master mechanic of the Sudbury division of the Canadian Pacific, with headquarters at Sudbury, Ont., succeeding T. Hambly, transferred.

C. F. WINN, master mechanic of the Chicago, Milwaukee & St. Paul, with headquarters at Milwaukee, Wis., has resigned.

CHARLES L. McILVAINE, master mechanic of the New York, Philadelphia & Norfolk at Cape Charles, Va., has been appointed master mechanic of the Philadelphia division of the Pennsylvania Railroad, to succeed J. L. Cunningham. Mr. McIlvaine was born in Wilmington, Del., on September 25, 1872. He received his early education in the public schools of Wilmington and Philadelphia and later graduated from the mechanical engineering department of the University of Pennsylvania. On October 1, 1899, he entered the service of the Pennsylvania Railroad as an apprentice in the shops at Wilmington and was



C. L. McIlvaine

afterwards transferred to the Altoona shops. He was promoted to draftsman in the office of the superintendent of motive power at Jersey City, N. J., in January, 1903, and was advanced to motive power inspector in February, 1905. In May, 1905, he was appointed assistant master mechanic at the Pavonia shops at Camden, N. J., on May 1, 1907, assistant engineer of motive power at Buffalo, N. Y., and on May 1, 1911, was transferred to the office of the general superintendent of motive power at Altoona, Pa., in the same capacity. On July 1, 1913, he was appointed master mechanic of the New York, Philadelphia & Norfolk at Cape Charles, Va., holding that office until May 9, 1917.

CAR DEPARTMENT

S. W. CATON, general car inspector of the Western Maryland at Hagerstown, Md., has been promoted to master car builder with headquarters at Hagerstown.

SHOP AND ENGINEHOUSE

W. T. ABINGTON has been appointed superintendent of shops of the Denver & Rio Grande, with office at Salt Lake City, Utah, succeeding E. J. Harris, promoted.

PAUL BISCHELD has been appointed district foreman of the Union Pacific, at Salina, Kan., succeeding J. A. Brice.

E. J. BRENNAN, shop superintendent of the Baltimore & Ohio at Glenwood, Pittsburgh, Pa., has been promoted to general master mechanic with headquarters at Pittsburgh, succeeding G. A. Schmoll.

F. G. FLESHER has been appointed locomotive foreman of the Canadian Northern at Lucerne, B. C., succeeding T. C. Young, transferred.

W. G. HALL has been appointed shop superintendent of the International & Great Northern, with office at Palestine, Texas, succeeding W. A. Brule, promoted.

JOHN LEE, formerly locomotive draftsman at the Winnipeg shops of the Canadian Pacific, has been appointed shop engineer at that point.

H. A. LYDDON has been appointed superintendent of shops of the Northern Pacific, with office at South Tacoma, Wash., succeeding F. W. Malott, retired from active service.

F. OSBOURNE has been appointed millwright foreman at the Winnipeg shops of the Canadian Pacific.

W. W. SCOTT has been appointed shop superintendent of the Buffalo, Rochester & Pittsburgh, with office at Punxsutawney, Pa.

R. B. STOUT, master mechanic of the Baltimore & Ohio at Cumberland, Md., has been appointed shop superintendent at Glenwood, Pittsburgh, Pa., succeeding E. J. Brennan.

T. C. YOUNG, locomotive foreman of the Canadian Northern at Lucerne, B. C., has been appointed locomotive foreman at Port Mann, B. C., succeeding W. M. Armstrong, who has enlisted for active military service.

PURCHASING AND STOREKEEPING

WILLIAM S. MOREHEAD has been appointed assistant general storekeeper of the Illinois Central, with office at Chicago, Ill., succeeding William Davidson, promoted. He will have jurisdiction over the northern lines.

WILLIAM DAVIDSON, assistant general storekeeper of the Illinois Central at Chicago, has been appointed general storekeeper, with office at Burnside (Chicago). He was born at



W. Davidson

Selma, Ala., and after leaving school served an apprenticeship in steam and gas fitting, for two years, being employed by the United Gas & Improvement Company, Vicksburg, Miss. In 1893, he entered railway service with the Yazoo & Mississippi Valley at Vicksburg as a car repairer, later serving consecutively as master car builder and wheel clerk, stock-keeper, file clerk, assistant timekeeper, general timekeeper, accountant, storekeeper

and assistant chief clerk to the master mechanic. In June, 1908, he was appointed division storekeeper at Vicksburg, and in May, 1910, was promoted to assistant general storekeeper of the Illinois Central and the Yazoo & Mississippi Valley at Burnside (Chicago).

THOMAS H. RYAN has been appointed purchasing agent of the Alabama & Vicksburg and the Vicksburg, Shreveport & Pacific, with office at New Orleans, La. He was born at New Orleans on March 31, 1886. He entered railway service on July 7, 1903, as a stenographer in the general passenger department of the New Orleans & North- appointed Alabama & Vicksburg and the Vicksburg, si continue his cific. From December, 1905, to April epartment. secretary to the president and gen of directors of the Indecompanies, and from April ay, Chicago, held on May 3, chief clerk in the purch late president, James Buchanan continued to fill up vice-president, was elected president. ger of the New York office of this com-

above. He succeeds W. J. Kelliher, resigned to enter other business.

W. A. SUMMERHAYS, general storekeeper of the Illinois Central at Burnside Shops, Ill., has been appointed assistant purchasing agent of the Illinois Central and the Yazoo & Mississippi Valley, with headquarters at Chicago. Mr. Summerhays was educated in the Chicago public schools and the University of Illinois. In June, 1898, he entered the service of the Illinois Central as an engineering apprentice assigned to track work, and in 1900 he became section foreman. The following year he was appointed general foreman of construction and later in the same year became assistant general storekeeper. In May, 1910, he was appointed general storekeeper of the same road, which position he held at the time of his recent appointment as assistant purchasing agent.



W. A. Summerhays

H. P. SHANKS, assistant purchasing agent of the Louisville & Nashville at Louisville, Ky., has been appointed purchasing agent, succeeding J. P. Harrison, resigned.

ERNEST BAXTER has been appointed general storekeeper of the Wabash, with office at St. Louis, Mo., succeeding A. J. Sewing, assigned to other duties. Mr. Baxter was born at Delmer, Ont., on October 11, 1882. He began railway work with the Michigan Central in March, 1903, as a messenger in the local freight office, and in May, 1903, was employed by the Algoma Central & Hudson Bay at Sault Ste. Marie, Ont., in a similar capacity. In October, 1903, he was appointed secretary to the superintendent of the Grand Trunk at London, Ont., and in April, 1905, entered the operating department of the Cincinnati, Hamilton & Dayton at Indianapolis, Ind., and later that of the Missouri Pacific at St. Louis, Mo. He was appointed secretary to the general manager of the St. Louis Southwestern at St. Louis in February, 1906, and in May, 1909, was promoted to chief clerk to the president. From June, 1914, to February, 1916, he was purchasing agent of this same company, and from March 1, 1917, to April 30, assistant a service inspector for the Wabash at St. Louis, and the Philade held at the time of his appointment, noted referred to Altoona asrt to J. E. Taussig, vice-president, at was promoted to master a. on October 1, 1901, and on -een appointed division store- to West Philadelphia as master aCentralia, Ill., succeeding



E. Baxter

OBITUARY

JOHN HEATH, formerly master mechanic on the Wisconsin division of the Chicago & North Western, died at his home in Winnetka, Ill., on May 1.

ROSCOE B. KENDIG, chief mechanical engineer of the New York Central Railroad, with headquarters at Grand Central Terminal, New York, died suddenly on May 10, in Detroit, Mich., while attending a conference with officers of the Michigan Central Railroad. Mr. Kendig was born on March 3, 1868, at Renovo, Pa., and was educated in the public schools of his native town. He began railway work in 1884 as a messenger boy on the Pennsylvania Railroad. From May, 1885, to August, 1890, he served as machinist apprentice at Renovo, and then to January, 1893, as draftsman at the same place. He was then for seven years draftsman in the office of the superintendent of motive power of the same road, at Williamsport. On January 17, 1900, he was appointed chief draftsman of the Lake Shore & Michigan Southern at Cleveland, Ohio, and from March, 1904, to June, 1910, he was mechanical engineer of the same road. In June, 1910, he was appointed general mechanical engineer of the New York Central Lines, and in May, 1912, became chief mechanical engineer of the New York Central Railroad.



R. B. Kendig

ALBERT E. MANCHESTER, general superintendent of motive power, Chicago, Milwaukee & St. Paul, with headquarters at Milwaukee, Wis., died at his home in that city May 4, aged 70 years. He was born February 12, 1847, at Beaver Dam, Wis., and entered railway service in 1864 as an apprentice in the mechanical department of the Chicago, Milwaukee & St. Paul. Consecutively he was for five years a machinist at Milwaukee, for 17 years a round-house foreman at various points along the line, for two years general foreman of the locomotive department, and for four years division master mechanic for the southwest district, including both car and locomotive departments. On April 1, 1893, he was appointed assistant superintendent of motive power for this company, and on June 15, 1901, was promoted to superintendent of motive power, with jurisdiction over the entire system. In recognition of his long and faithful service, extending over a period of more than 50 years, he was recently promoted to general superintendent of motive power. Mr. Manchester was an active member of the M. M. and M. C. B. associations for 23 years.



A. E. Manchester

SUPPLY TRADE NOTES

McCord & Co., of Chicago, has moved its New York office from 50 Church street to 165 Broadway.

The Okonite Company, Chicago, has moved its New York office to the Astor Trust building, 501 Fifth avenue.

J. T. Luscombe has been elected vice-president and general manager of the Paxton-Mitchell Company, Omaha, Neb.

The Goodwin Car Company has removed its Chicago office from 10 South La Salle street to 10 East Jackson Boulevard.

The Barry Equipment Company, Chicago, Ill., announces that it has changed its corporate name to the Barry Company, Limited.

Robert Radford, for many years secretary and treasurer of the Standard Steel Works Company, Philadelphia, Pa., has been elected also president of the Southwark Foundry & Machine Company, Philadelphia.

Mr. Radford was graduated from Girard College in 1894, and soon after went with the Baldwin Locomotive Works. In 1906 he was transferred to the Standard Steel Works in substantially the same position he now occupies, and which he will continue to fill in addition to the presidency of the Southwark Foundry & Machine Company. Much of the success of recent years of the Standard Steel Works Company has been due

to Mr. Radford's tireless and well-directed energy. He is thus well fitted for his new executive work.

John W. Dix, assistant general manager of sales and structural engineer of the Carnegie Steel Company, died at Atlantic City, N. J., April 28.

B. T. Bectel, who has been in charge of the Pittsburgh office of the Mark Manufacturing Company, Evanston, Ill., since 1912, has been appointed assistant general manager of sales for this company, with headquarters at Evanston.

Walter Brunswick, formerly connected with the sales department of the American Locomotive Company, has been appointed engineer in charge of the engineering department of Dowler, Forbes & Co. of New York and Shanghai.

The Coleman Railway Supply Company has been organized by W. W. Coleman and George E. Neil as partners, with office at 30 Church street, New York. The company will handle a general line of railway appliances and supplies.

Richard A. Van Houten, for the past four years sales agent of the Sellers Manufacturing Company, Chicago, has been appointed manager of the plant at Mayfair (Chicago), where he will have complete charge of manufacturing operations.

E. L. Ruby, for the past year eastern representative for the Hayes Track Appliance Company, Richmond, Ind., has opened an office in the Real Estate Trust building, Philadelphia, Pa. In addition to Hayes derrails he will handle

the sale in eastern territory of the Keystone tool grinder made by the Keystone Grinder & Manufacturing Company, Pittsburgh, Pa.

G. A. Cooper, formerly in the copy service department of the Simmons-Boardman Publishing Company, Chicago, has been appointed a representative in the railroad department of the United States Graphite Company. His headquarters are at Chicago.

H. I. McMinn, formerly with the Pennsylvania Railroad, has entered the service of the Franklin Railway Supply Company as shop superintendent in charge of the manufacture of the Stone-Franklin lighting equipment, with headquarters at Bush Terminal, Brooklyn, New York.

F. H. Van Sweringen, formerly master car builder of the Streets Company and more recently superintendent of the Welland (Ont.) plant of the Canadian Steel Foundries, has been appointed Chicago representative of Brown & Co., Inc., Pittsburgh, Pa., makers of refined irons and steels.

The Acme Supply Company changed its corporate name on June 1 to the Dunbar Manufacturing Company. The sales organization will remain substantially the same, with the exception that a new sales office has been opened at St. Paul, Minn., with Rank & Goodell as sales representatives.

The Freeland derrails and Newton replacers previously sold by the Hobart Alfree Company, Old Colony building, Chicago, have been sold to the Q & C Company, New York, St. Louis and Chicago, who will hereafter include these devices with the Fewings car replacers and the Q & C adjustable derrails now sold by the Q & C Company.

J. B. Ennis, chief mechanical engineer of the American Locomotive Company, since December, 1912, has been appointed vice-president, in charge of engineering. Mr. Ennis has been in the service of the American Locomotive Company since its incorporation in 1901, prior to which time he was with the Rogers and Schenectady Locomotive Works.

John G. Barry has been appointed general sales manager of the General Electric Company. Mr. Barry has long been manager of the company's railway department, and is well

known throughout the electrical industry. He began his business career as a production clerk for the Thomson-Houston Company at Lynn, Mass., in 1890. Soon, however, he was transferred to the company's Boston office in the commercial department. In 1892 the Thomson-Houston Company and the Edison General Electric Company were united to form the General Electric Company, and two years later Mr. Barry was transferred to Schenectady in the

railway department. He was soon made assistant manager of the railway department, and in 1907 he was appointed manager of the department. Mr. Barry will continue his present duties as manager of the railway department.

At a special meeting of the board of directors of the Independent Pneumatic Tool Company, Chicago, held on May 3, to elect a successor to its late president, James Buchanan Brady, John D. Hurlley, vice-president, was elected president. R. S. Cooper, manager of the New York office of this com-



R. Radford



J. G. Barry

pany, has been elected vice-president, succeeding Mr. Hurley. Robert T. Scott, manager of the company's Pittsburgh office, has been elected a director and member of the executive committee.

Keith R. Rodney, for many years connected with the Midvale Steel Company, and for the past two years supervisor of heat treating at the Winchester Repeating Arms Company, New Haven, Conn., has recently joined the staff of the Bullard Machine Tool Company as metallurgist and special counselor in the selection and treatment of steels.

J. W. Deetrick, for some years general manager of the Republic Iron & Steel Company, Youngstown, Ohio, has been elected second vice-president and also a director of the company. The title of general manager has been abolished, but Mr. Deetrick will continue to exercise supervision over operations at all of the plants and will be known as second vice-president in charge of operation.

In order to supply more readily the increasing demand for S K F bearings on the Pacific Coast, the S K F Ball Bearing Company, of California, Inc., has been organized. The main office of this company, under the direction of A. M. MacLaren, has been opened in San Francisco at 341 Larkin street. At this office a large and assorted stock of bearings will be carried, and the engineering services of the company will be available.

The Joliet Railway Supply Company, Chicago, has appointed Atkinson & Utech, Inc., 111 Broadway, New York, its eastern sales agents, to handle its business in eastern territory and all export business where the purchasing is done in New York. The Joliet Railway Supply Company has also appointed the following representatives: V. J. Burry, mechanical engineer, with headquarters in Chicago; Jos F. Leonard, Mutual building, Richmond, Va.; W. M. McClintock, Hackney building, St. Paul, Minn.; Alfred Connor, Majestic building, Denver, Col.; F. F. Bodler, Monadnock block, San Francisco, Cal.; W. F. McKenney, Portland, Ore.; S. I. Wailes, Los Angeles, Cal.

L. R. Pomeroy, consulting engineer, with office at 30 Church street, New York, died suddenly on May 7. Mr. Pomeroy had been in the railway and railway supply business for more than 35

years, and had a very wide acquaintance. He was born at Port Byron, N. Y., in 1857, and was educated at Irving Institute, Tarrytown, N. Y. From 1880 to 1886 he was secretary and treasurer of the Suburban Rapid Transit Company of New York, and then for nine years he was with the Carnegie Steel Company, introducing basic boiler steel for locomotives and special forgings. Subsequently he engaged in the same kind of work

with the Cambria Steel Company and the Latrobe Steel Company jointly. For three years to 1902 he was assistant general manager of the Schenectady Locomotive Works, and then for six years represented in the railway field the General Electric Company. Then he went to the Safety Car Heating & Lighting Company, and afterwards to J. G. White & Co. as chief engineer of the railway and industrial divisions. In June, 1914, he was appointed manager of



L. R. Pomeroy

the New York sales office of the United States Light & Heating Company, and later opened an office as consulting engineer.

Robert L. Gordon, assistant to the president of the Standard Steel Car Company, has been elected vice-president of that company, and vice-president of the Forged Steel Wheel Company and other associated companies, succeeding James B. Brady, deceased. Mr. Gordon graduated from Cornell University, class of 1895, with the degree of mechanical engineer, and after leaving college went with the Baldwin Locomotive Works. He was afterward connected with the Fox Pressed Steel Equipment Company, and later with the Pressed Steel Car Company, and has been connected with the Standard Steel Car Company since its organization, having acted as assistant to the president for the last 12 years.

Harry C. Quest, for a number of years a representative of paint and varnish companies in the railway supply field, has associated himself with A. A. Ridgway, in the Ridgway-Quest Company, which

was recently organized to manufacture paints and varnishes, at Chicago. Mr. Quest has been elected president of this company. He began his career in the railway supply business in 1901 with the Heath & Milligan Company, Chicago, and since then has been engaged in the sale of paints and varnishes to the railways, car companies and allied industries. The new plant of the Ridgway-Quest Company has been especially equipped for the production of these materials for the railway field. Mr. Quest will cover the entire United States. Branch offices will be established in New York City and Denver, Colo.



H. C. Quest

William Lodge, president of the Lodge & Shipley Machine Tool Company, Cincinnati, Ohio, died suddenly April 31, 1917. William Lodge was born in Leeds, England, in 1848. He attended the common schools until at the age of 17 he became an apprentice at the machine shops of Fairburn & Co., of Leeds, where his term of indenture covered four years. He then came to the United States and resided in Philadelphia until 1872, when he went to Cincinnati, and shortly afterward became foreman in the shops of Steptoe, McFarland, Nottingham & Co. The senior member of the firm, John Steptoe, was the first machine-tool manufacturer west of the Alleghenies. After eight years with this concern, Mr. Lodge entered into partnership with William Barker, and they conducted a successful business in the manufacture of machine tools under the firm name of Lodge, Barker & Co. In 1886 Mr. Barker disposed of his interest to Charles Davis, and the company was reorganized under the name of Lodge & Davis. Six years later, in 1892, Mr. Lodge withdrew from the firm, and the same year organized the Ohio Machine Tool Company, the organization being continued till 1893, when he became associated with Murray Shipley, and the present company was incorporated under the name of the Lodge & Shipley Machine Tool Company, of which Mr. Lodge was president. Mr. Lodge was the author of "Rules of Management with Practical Instructions on Machine Building." He was a member of the American Society of Mechanical Engineers, joining the society in 1890.

Railway Mechanical Engineer

Volume 91

July, 1917

No. 7

CONTENTS

EDITORIALS:

Wooden Freight Equipment.....	367
Keep the Shop Equipment in Repair.....	367
Support the Committee on National Defense.....	368
Air Compressors in Yards.....	368
Shortage of Railway Mechanics Threatened.....	368
New Departure in Locomotive Design.....	369
Conserve the Motive Power.....	369

GENERAL:

P. R. R. Decapod Type Locomotive.....	370
Power House Economics.....	373
The Ninth Regiment of Engineers.....	376
Pennsylvania Electric Locomotive.....	379
New Power for Southern Railway.....	381
Graphic Display of Individual Daily Fuel Records.....	383

CAR DEPARTMENT:

Handling Heavy Trains on Grades.....	385
Steel Passenger Train Equipment.....	386
Erie Steel Passenger Equipment.....	387
Slack Action in Long Passenger Trains.....	389
Wooden Stock Cars for the I. C.....	391
The Safety Appliance Standards.....	393

SHOP PRACTICE:

Driving Box Spring Seat Milling Machine.....	397
Milling Machine Practice in Railway Shops.....	397
Reclaiming Air Pump Packing Gland Rings.....	398
Rod Work on the Chesapeake & Ohio.....	399
Interesting Back Shop Performance.....	401
Handling Rod Repairs.....	405
Reclaiming Cast Iron Wheels.....	406
Chuck for Finishing Piston Valve Packing Rings.....	407
Emergency Injector Repairs.....	407

NEW DEVICES:

Duplex Locomotive Stoker.....	408
Blue Signal Safety Device.....	410
Murray Key Attachment.....	411
Positive Locking Power Reverse Gear.....	411
Portable Column Boring Bar.....	412
Crank Pin Inspection Gage.....	413

NEWS DEPARTMENT:

Notes.....	414
Meetings and Conventions.....	415
Personal Mention.....	415
Supply Trade Notes.....	416
Catalogues.....	420

Wooden Freight Equipment

For the past two years some of the rail-ways in view of the high price of steel and poor deliveries, have gone quite extensively to the use of wood in the construction of freight equipment. The experience of the railroads with some of this equipment has not been at all satisfactory and the situation demands the most careful consideration. It must be remembered that the railroads are handling an unprecedented amount of traffic which must be moved with despatch and without delay. It is true the railroads need cars and need them badly, but a car of weak construction that will cause delay to the trains on the road will cost more in the delay to the traffic and the possible damage to other equipment than that car is worth. It is highly essential, therefore, that whatever cars are built be built to withstand the heavy service conditions now prevailing. Examples of wooden cars built only two years ago and which are now unsuitable for further service show that the construction of wooden equipment has not been given the proper consideration.

There is no question but that wood can be used to a large extent where steel was previously used and a good car be built. There is, however, hardly a case where the strictly all-wood car can be used satisfactorily. A certain amount of steel must be used to properly reinforce the wooden members. For instance, it is folly to attempt to build a drop bottom gondola car entirely of wood. The construction of this type of car is such that it can hardly be built to withstand the service to which it is put. Steel underframes should be required on this class of equipment. The house car, however, offers a greater possibility for the more extensive use of wood, but here, metal draft arms, or still better, metal draft sills with the proper arrangement of truss rods should be used.

The demands of the government for adequate equipment

require that the most careful consideration be given to this subject. There are no short cuts that can be made to meet the present conditions. Car designers should follow carefully the fundamental principles of good car design. There is no telling how long these extreme demands on the railroads are to last; even if the war should end within a year, there is no question but that America would be called upon to give of her resources for the rehabilitation of the countries that have been at war for the past three years. The situation demands the most careful thought and every effort should be made to build substantial equipment which will not clutter up the repair tracks with bad order cars.

Keep the Shop Equipment in Repair

Such are the remarkable conditions in this country at the present time that not infrequently we hear of cases where shop equipment manufacturers find it necessary to make a careful survey of their customers' needs to find out which ones should have their orders filled first for the best interests of the country at large. This immediately raises the question as to whether or not the railroads cannot be of assistance to the country as a whole by endeavoring to maintain their shop equipment in better condition than heretofore. It may be found practicable to rebuild the equipment which in the past has been scrapped and replaced, but which can not readily be replaced under present conditions. It is an economic question in which the price of the equipment, the available labor necessary for the work and the facilities for doing the work, must be carefully considered. Some shops maintain what is called the repair gang, which devotes its entire time to the maintenance of the equipment in the shop. Should or should not this gang be increased in force and be provided with additional facilities for doing more extensive work on the shop equipment than it has hitherto been called upon to do? It is a question

the answer to which will be governed by conditions and one which each railroad will have to decide for itself. It should, however, be given consideration. The greatest problem in the railroad shop today is to get the cars and locomotives back into service in the shortest possible time consistent with good workmanship. More time spent in the maintenance of shop equipment and in the increasing of its efficiency, will increase the output and the efficiency of the shop, but the question as to how far these improvements should be made depends, as stated above, upon the availability of new shop equipment, its cost, and the forces necessary to properly do this work.

**Support the
Committee on
National Defense**

Many things seem to indicate that of all the industrial and economic forces of the nation, the railroads come nearest to a full realization of what the country must face in the months to come. Not only must they handle a volume of traffic wholly unprecedented with facilities apparently already overtaxed, but they must handle it in the face of an inadequate supply of labor in the maintenance departments, which will be reduced still further by the removal of over three-quarters of a million men from civil pursuits during the next three months. That facilities can be increased in time to relieve the situation seems hardly possible at this time. Therefore the only possible way to meet the demands for transportation is to increase the efficiency of present facilities. A special committee on national defense has been organized by the American Railroad Association to bring about this increased efficiency by operating the railroads practically as a single system. If the committee is properly supported by all the roads there need be no doubt as to the result. In a bulletin issued on May 9, and printed in our June issue a number of expedients whereby remarkable improvements may be brought about in the effectiveness with which existing facilities may be utilized were outlined. The presidents of the railroads have given this committee authority to formulate policies for all or any of the roads during the war. This alone, however, will not solve the transportation problems during the coming months, and possibly years, of the war. Unless every officer, every man, gives the committee his wholehearted and unqualified support in carrying out its suggestions and policies, the railroads will fall short of the full measure of success that can be attained in the present emergency and the nation will play but a halting part in a world crisis. Truly, teamwork is the railroads' supreme patriotic duty to the nation.

**Air
Compressors
in Yards**

There are comparatively few freight yards which have facilities for testing brakes before the engine is coupled to the train. This practice has so many advantages, however, from both maintenance and operating standpoints, that it seems that it should be more generally used. It makes it possible to determine the condition of the brakes far enough in advance of the time when cars are to leave to permit proper repairs being made and speeds up the handling of trains by reducing the time they are held at terminals for inspection.

Proper maintenance of the air brake is necessary not only for the sake of safety but also to secure economy of operation. Men who are familiar with the condition of equipment agree that the general standard of air brake maintenance is not what it should be. Brakes cannot be kept in the proper condition unless they are tested before the engine is attached to the train and while a test on all incoming trains is of great assistance in improving the condition, it does not take care of cars received from connecting lines. Shocks resulting from variations in braking power between the cars in different parts of a train are

responsible for many breaks-in-two and for other less serious damage to draft gear. It is out of the question to try to adjust the piston travel on a freight train while it is being inspected. Lack of attention to the air brakes also results in loss of fuel due to stuck brakes and leaks in the train line.

It is unreasonable to expect a car inspector to look over a train and correct all the defects in the 15 or 20 minutes usually available between the time when the engine is coupled to the train and when it is scheduled to leave. The inspector is obliged to pass by many defects which should be remedied merely because he has not the time to correct them. It might be argued that by having more inspectors the work could readily be handled after the engine is on the train, but even if a larger force was employed it would hardly be possible to avoid delaying trains. Even though the delay is not long enough to involve any terminal overtime for the train crews it makes it difficult for the dispatcher to arrange meeting points and as a result the time the trains are on the road is increased. When all things are considered, the advantages of having air compressors in yards are so evident that their installation seems essential for the economical operation of large freight terminals.

**Shortage of
Mechanics
Threatened**

The withdrawal of mechanics from railway service during the past few months has caused a critical situation on some railroads. A large number of men have already been recruited from the roads, both in the railroad regiments and in the regular service, and there is a prospect that more will be drafted. Mechanical officers are viewing with alarm the further depletion of their forces. At this time the urgent demand for locomotives and cars makes the prompt repairing of equipment of the utmost importance and railroad mechanics may perform quite as great a service for their country by remaining at their posts as they could by going to the front.

In England the railroads released about 25 per cent of their normal force of employes for military service and the scarcity of railroad mechanics became so serious that it was found necessary to make them exempt. To avoid if possible a similar situation in this country the Railroads' War Board has asked the Council of National Defense to define the government policy with regard to the enlistment of machinists or other skilled railway employes. In view of the experience of the British roads a consideration of the subject at this time seems advisable.

There is no question that the railroads will be called upon to handle heavier traffic during the war than they ever have before and it is conceded that the highest efficiency in handling this traffic is essential if this country is to do its share in the great struggle. Locomotives and cars will therefore be at a premium. The unusually large proportion of the output of the locomotive and car works of the United States which are being exported to the allied countries will reduce the amount of new rolling stock available for American roads during the war, and for that reason all existing equipment must be kept in efficient condition. This cannot be done unless the car and locomotive repair shops are worked at their full capacity. Therefore a full complement of mechanics is necessary. If skilled workmen are drawn away from the shops in large numbers the efficiency of the railroad systems may be seriously impaired.

Recently a large number of men have left railroad shops to work at the navy yards. In one shop 12 machinists resigned in a single day as a result of the government campaign to secure mechanics. Notices to the effect that men were wanted for service in the navy yards had been distributed at other shop points and the situation became so critical that the government was requested to withdraw them. This was done without delay. The railroads will find it hard to replace

mechanics who leave the shops at this time, as men who have been trained in other industries cannot as a rule be used successfully on railroad work. The navy yards could no doubt use mechanics drawn from other sources, where their positions might be filled by women. Recruiting of mechanics for navy yards from the railroads should be discouraged.

The problem of maintaining the efficiency of the railroads during the war is one which the experience of the Allies will help us to solve. While the situation in the shops has not as yet become acute except on a few roads, mechanical department officers should keep in close touch with the labor situation in order to avoid a disorganization of their forces.

New Departure in Locomotive Design

The design of the Pennsylvania Decapod type locomotive, a description of which is published elsewhere in this issue, involves one of the widest departures from the well worn groove of conventional practice which has ever been undertaken. The constantly growing demand for increased locomotive capacity has led to the successful development or adoption in this country of many labor saving and capacity increasing devices, such as the locomotive stoker, the superheater and brick arch, and yet the ability to continually increase locomotive capacity within the limitations imposed by track conditions and right-of-way clearances has been severely taxed. In the Pennsylvania locomotive the possibility of still further increasing the capacity has been created by eliminating the uneconomical range of cut-offs ordinarily employed at slow and moderate speeds. It is evident that high tractive effort obtained by working the locomotive at full stroke is accompanied by a waste of steam as compared with the expansive use of the steam at higher speeds. The limitation of the maximum cut-off not to exceed 50 per cent at starting and during slow speed operation, the cylinders being increased in size to offset the decrease in mean effective pressure per unit area, offers a most promising field for the conservation of the steam supply which may be utilized to develop increased horsepower for a given boiler size. In this connection, however, the fact should not be overlooked that the stresses on the running gear are increased by this practice, owing to the higher initial piston load necessary to produce a given mean effective piston pressure as compared with that from a full stroke card. This will require somewhat heavier reciprocating parts as well as larger rods and crank pins and may be expected to increase the wear and tear throughout the running gear. These, however, are conditions which it should be possible to take care of without difficulty, especially in the case of freight locomotives, the class of power on which the arrangement under discussion offers the greatest advantages. There are a number of incidental advantages which this arrangement offers, such as a more uniform starting torque and therefore a decreased tendency toward slipping, which will add to the interest with which the thorough testing out of this locomotive in service will be followed by locomotive designers throughout the country. Unless the difficulties of maintenance prove greater than expected, no reason is apparent why the new method of proportioning cylinders and limiting the cut-off should not become a well established feature of American locomotive practice.

Conserve the Motive Power

The need for locomotives was never greater than it is today, and the possibility of obtaining locomotives from the builders was never worse, the best deliveries obtainable being from nine to twelve months. In addition to this, locomotive prices are extremely high, and our Russian allies want 2,000 locomotives from us. "Locomotives, locomotives and still more locomotives" are the fundamental needs of Russia today. Professor Lomonosoff, railroad minister with the Russian mission, told Wash-

ington newspaper men in an interview. "Quite frankly I can say to you, our American friends," he said, "give us locomotives and we shall give you military success."

It is, therefore, apparent that the railways in this country are in a very peculiar situation and every means must be taken to get the greatest possible service out of the available power. The Railroads' War Board has asked that the number of locomotives under repair be reduced from 15 to 10 per cent, thereby increasing the number of locomotives available for service by 3,000. In view of the shortage of labor which is being felt the country over, this is a difficult thing to do, but it must be done and every member of the mechanical department of the railways should consider it his patriotic duty to do what he can to reduce the number of locomotives in shop or awaiting repairs and thereby increase the country's supply of motive power. In speeding up the work of locomotive repairs, the quality of the work cannot be sacrificed. An engine failure during this time of congested traffic is expensive and increases the congestion. The workmanship therefore must be at least equally as good as formerly. It is the efficiency of the shops that must be increased and with it, the shop output.

With the prices for new equipment as they are, the advisability of equipping power with capacity increasing devices and other devices which decrease the time a locomotive spends in the shop must be given careful consideration. A thorough economic study should be made of the entire situation so that locomotives may be used to the best advantage and so that money for additional power may be spent where it will produce the greatest returns. Many roads have restricted their passenger service for the purpose of relieving congestion and to increase the available supply of men and material. In some cases passenger locomotives can be used in freight service. Wherever this is done care must be taken not to use them where they will interfere with the expeditious movement of freight. They can be used to advantage in doubleheading on fast freight trains and in releasing fast freight locomotives for use in slower service.

The terminal delay of the locomotive must be reduced. This may be done by a more logical arrangement of the terminal tracks and facilities, by the use of inspection pits, by the consolidation of trains and by running locomotives over two divisions where it is possible to do so. One road has eliminated 34 terminal handlings of locomotives and released 3 locomotives for other service by following the latter practice. This not only increased the availability of power, but materially decreased the fuel consumption costs. It has been estimated that a saving of about six dollars a day was made for each locomotive that covered two divisions.

Whether a road operates on the pooled or assigned system, the enginemen should be made to feel the responsibility they bear to the railways and their country in the present situation. The engine crews should be instructed how to get the most out of their power and supervision should be adequate to see that the instructions are carried out. The engine crews can be of particular assistance and a very great help in making proper and complete work reports at the end of their runs in order that the defects may be promptly located and repairs made with despatch.

It is every man's duty as a citizen, from the helper to the man in charge of the mechanical department, to do his level best on the work assigned to him, to work harder and to use his head as well as his hands in increasing the effectiveness of the motive power on our roads. There is no short cut to the accomplishment of this end. The fundamentals of good locomotive maintenance and operation should be followed more closely even than in the past. Every penny spent on a locomotive must be made to do its bit, every ounce of a man's strength must be used to the best advantage, and every thought regarding the work must go towards increasing efficiency and producing more effective results.

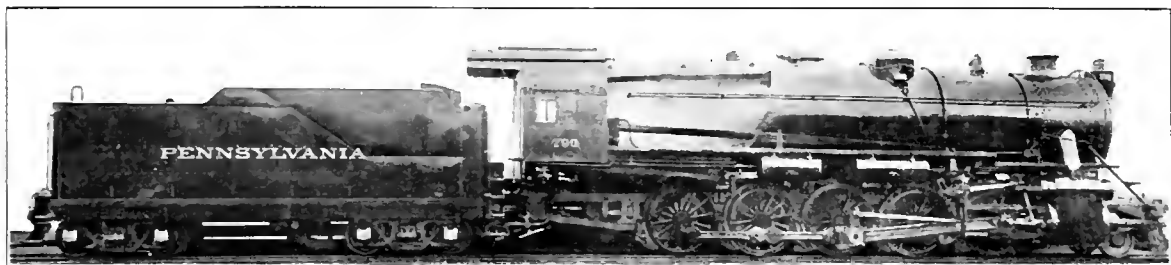

P. R. R. DECAPOD TYPE LOCOMOTIVE

Maximum Cut-Off Is 50 Per Cent; Tractive Effort
80,640 Lb. at 7 M. P. H.; Boiler Pressure 250 Lb.

IN December, 1916, a Decapod locomotive having a total weight of 366,500 lb., a weight on drivers of 334,500 lb. and a tractive effort of 80,640 lb. was built by the Pennsylvania Railroad at its Juniata shops. The locomotive is the first of its type to be placed in service on this road and is known as the I-1-s class.

There are several unique features in the design which represent wide departures from customary practice in locomotive engineering. Instead of operating at a maximum cut-off of approximately 90 per cent, the valves have been given a steam lap of two inches and the maximum cut-off with the reverse gear in the corner is 50 per cent. In order

of 82 in. and is made of 1½-in. plate, 1½-in. rivets in 1 9/16-in. holes being used in the longitudinal joints. Like the Mikado boiler, the main barrel course is made in two halves which are joined on the horizontal center line. The shoulders peculiar to the Belpaire type boiler are flanged integral with the upper half, and the rear end of the lower half is flanged to form the throat sheet. A one-piece pressed dome is mounted on this course. The boiler is fitted with a Schmidt superheater of 48 units placed in 5½-in. flues. There are 244 2½-in. tubes, the length between the tube sheets being 19 ft. The firebox includes a combustion chamber 3 ft. long and is equipped with a firebrick arch.

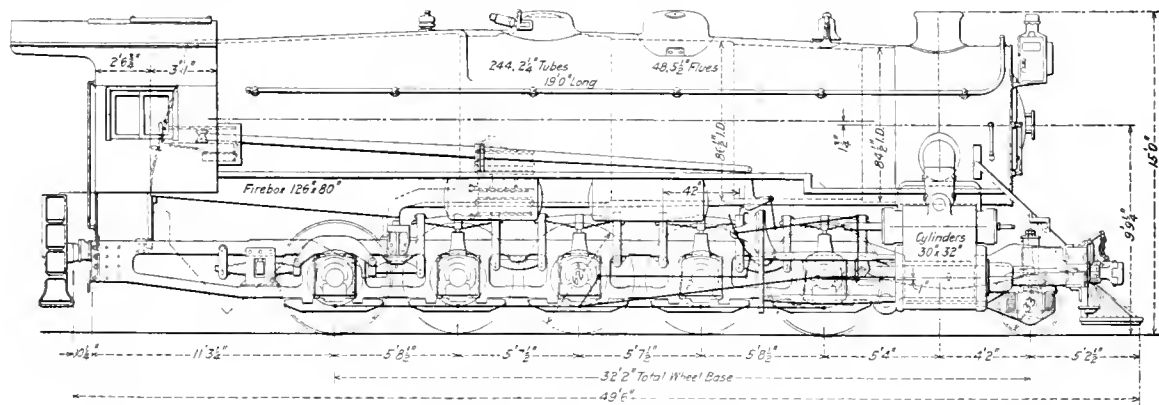

Elevation of the Pennsylvania 2-10-0 Type Locomotive

to secure a maximum tractive effort in proper relation to the weight on drivers, this necessitates the use of much larger cylinders than are required where 90 per cent cut-off can be obtained. The cylinders are 30 in. in diameter by 32-in. stroke and owing to clearance limitations which prohibit a further increase in the diameter of the cylinders, the boiler pressure was fixed at 250 lb. per sq. in.

With the notable exception of the high boiler pressure, the Decapod type boiler is of the same general design as that of the class L-1-s Mikados, a large number of which are now in service on the Pennsylvania Railroad.* While there are differences in details, it will be noted by a comparison of the data for the two types given in the accompanying table of dimensions, that there is little difference in the capacity of the two boilers.

The barrel of the boiler has a minimum internal diameter

The smokebox design is generally similar to that of the Mikado type locomotive. The exhaust pipe stands about 21 in. above the bottom of the smokebox and is fitted with a circular nozzle having four internal projections. The ring blower, however, has been removed from the nozzle tip and placed at the choke of the lift pipe, which is 17 in. in diameter. This arrangement is effected by the use of a combined blower ring and lift pipe bell casting, which is shown in detail in one of the drawings.

Each of the frames is a single steel casting 44 ft. 8¼ in. long with a driver brake shaft bearing cast integral. The top rail is 7 in. wide by 8 in. deep, the section changing to a width of 9½ in. and a depth of 7½ in. over the jaws; the lower rail is 6 in. deep. The single rail section to which the cylinders are attached is 5½ in. wide by 20 in. deep.

Steam is supplied to the cylinders through an 8½-in. dry pipe and 6-in. branch pipes, the admission being controlled by the balanced throttle valve. The steam distribution is con-

* This class was fully illustrated and described in the *Railway Age Gazette*, Mechanical Edition of July, 1914, on page 343.

trolled by 12-in. piston valves and Walschaert valve gear. With the exception of the increased lap which limits the maximum cut-off to 50 per cent, the arrangement does not differ from the usual Pennsylvania practice.

The use of a 2-in. steam lap necessitates some auxiliary

the auxiliary ports are so placed that their steam lap is 1/4 in. These ports serve to move the engine only until the main ports are opened.

The purpose of the use of the 50 per cent cut-off is to eliminate the range of cut-offs within which the water rate of the cylinders is excessive, thereby making possible an increase in the ratio of cylinder power to boiler capacity. By

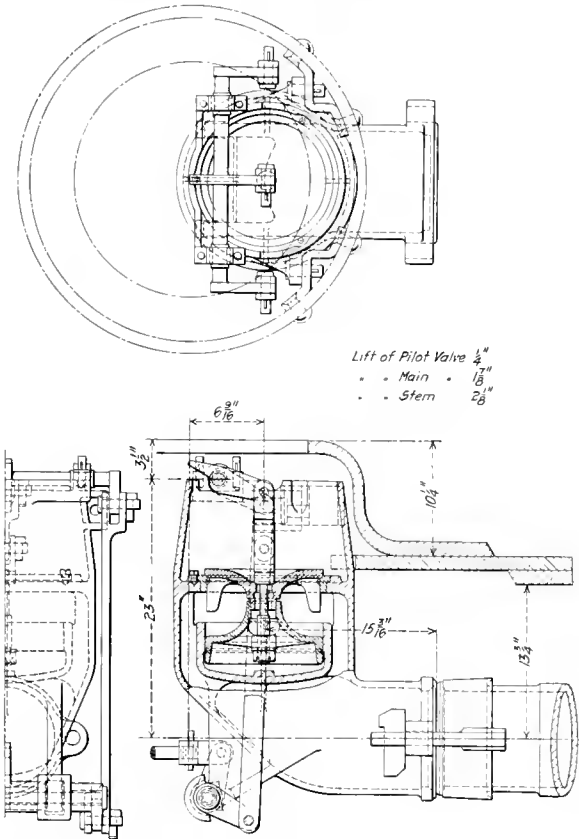

Throttle Valve of the Pennsylvania Decapod Type Locomotive

means of admitting steam to the cylinders when the locomotive is standing in order that it may be started from any position of the crank pins. The means of meeting this requirement is extremely simple. Pockets about 1 3/4 in deep are cored out of the inside edge of each steam port in the valve chamber, two in each port located 180 deg. apart.

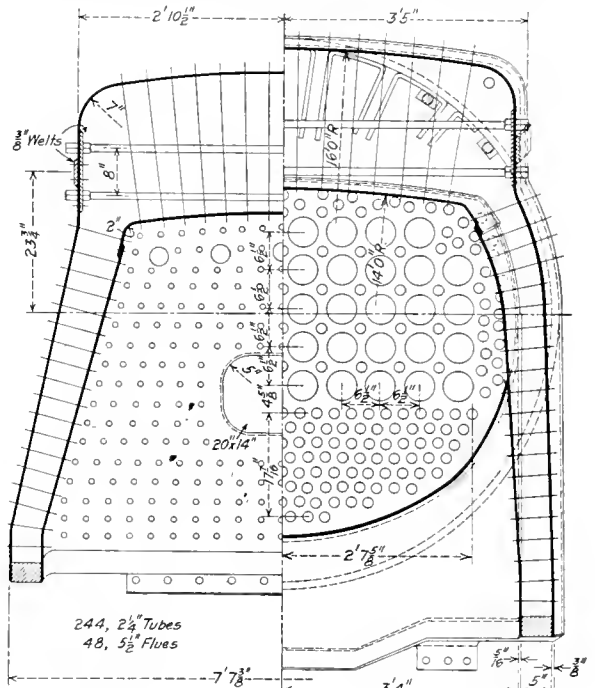

Half Sections Through the Firebox, Showing the Tube Layout

referring to the data for the two classes it will be seen that with but slightly increased boiler capacity an actual tractive effort at 7.2 miles per hour of 80,640 lb. is obtained from the class I-1-s locomotive as compared with a calculated maximum tractive effort of 57,850 lb. for the Mikado type. This is further reflected in the ratio of tractive effort times diameter of drivers to equivalent heating surface. As an indication of the extent to which this increased ratio is justified, it has been found that the tractive effort at 25 miles an hour is 44,400 lb.

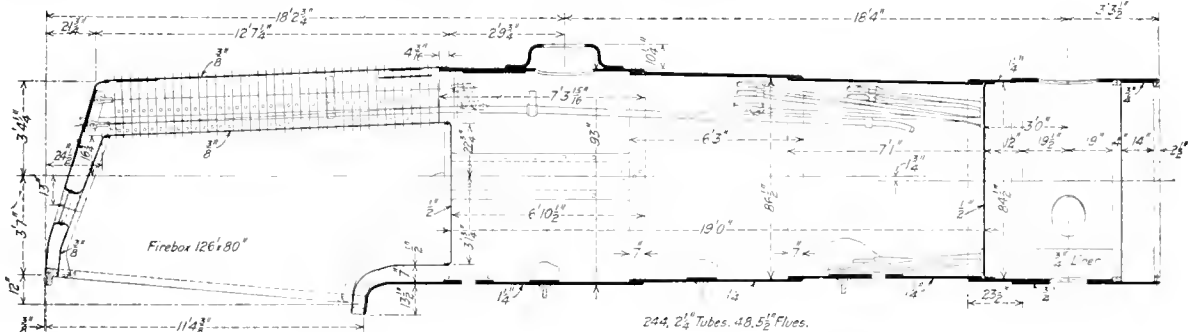

Boiler for the Decapod Locomotive, Which Carries 250 Lb. Working Pressure

Two ports 1/8 in. wide and 1 1/2 in. long are cut through the valve chamber bushing, opening into the pockets in the valve chamber casting. This arrangement is shown clearly in one of the illustrations, from which it will be seen that

The design of the running gear and reciprocating parts follows very closely that of the Mikado type locomotives. The piston is of rolled steel and is carried on an extension piston rod. The piston rod, driving axles, crank pins,

wrist pins and knuckle pins are all of hollow sections and are heat treated. In order to obtain a proper amount of clearance between the top of the rail and the bottom of the main rod at the rear end, the key bolt was put in from the bottom and this arrangement has been found to be very satisfactory. To obtain clearance between the rear end of the main rod and the side rod knuckle pins the special recessed knuckle pin and depressed nut were used.

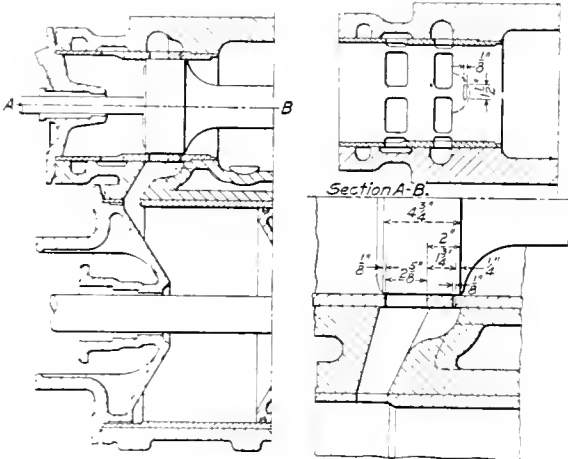

Valve Chamber with Auxillary Starting Ports

In the following table the principal dimensions and data for the Decapod type locomotive are shown in comparison with those for the class L-1-s Mikado type locomotive:

	General Data	
	Decapod Class L-1-s	Mikado Class L-1-s
Gage	4 ft. 8 1/2 in.	4 ft. 8 1/2 in.
Service	Freight	Freight
Fuel	Bit. coal	Bit. coal
Tractive effort	80,640 lb.*	57,850 lb.
Weight in working order	366,500 lb.	315,000 lb.
Weight on drivers	334,500 lb.	236,000 lb.
Weight on leading truck	32,000 lb.	27,000 lb.
Weight of engine and tender in working order	547,000 lb.	473,000 lb.
Wheel base, driving	22 ft. 8 in.	17 ft. 0 1/2 in.
Wheel base, total	32 ft. 2 in.	36 ft. 5 1/2 in.
Wheel base, engine and tender	73 ft. 1/2 in.	72 ft. 3 in.
Ratios		
Weight on drivers ÷ tractive effort	4.1	4.1
Total weight ÷ tractive effort	4.5	5.4
Tractive effort ÷ diam. drivers ÷ equivalent heating surface†	786.7	622.0
Equivalent heating surface† ÷ grate area	90.8	82.4
Firebox heating surface ÷ equivalent heating surface,† per cent.	4.3	5.1

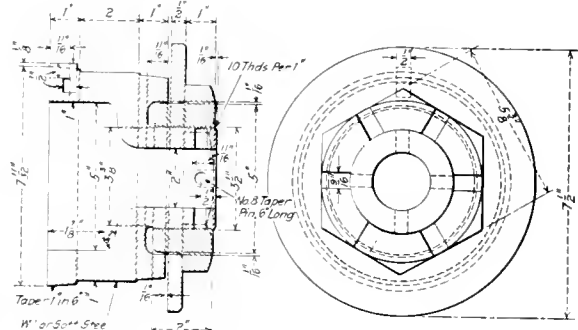

Details of the Knuckle Pin with Recess for Depressed Nut

Weight on drivers ÷ equivalent heating surface†	52.6	40.9
Total weight ÷ equivalent heating surface†	57.7	54.6
Volume equivalent cylinders with 90 per cent max. cutoff	21.4 cu. ft.	19.9 cu. ft.
Equivalent heating surface† ÷ vol. equivalent cylinders	297.0	260.0
Grate area ÷ vol. equivalent cylinders	3.3	3.5
Cylinders		
Kind	Simple	Simple
Diameter and stroke	30 in. by 32 in.	27 in. by 30 in.
Valves		
Kind	Piston	Piston
Diameter	12 in.	12 in.
Greatest travel	6 in.	6 in.
Steam lap	2 in.	3/8 in.
Wheels		
Driving, diameter over tires	62 in.	62 in.
Driving, thickness of tires	84 1/2 in.	3 1/2 in.
Driving journals, main, diameter and length	12 in. by 16 in.	11 in. by 15 in.
Driving journals, others, diameter and length	11 in. by 16 in.
Engine truck wheels, diameter	33 in.	33 in.
Engine truck, journals	6 1/2 in. by 12 in.	6 1/2 in. by 12 in.
Trailing truck wheels, diameter	50 in.	50 in.
Boiler		
Style	Belpaire	Belpaire
Working pressure	250 lb. per sq. in.	205 lb. per sq. in.
Outside diameter of first ring	84 1/2 in.	78 1/2 in.
Firebox, length and width	126 in. by 80 in.	126 in. by 80 in.
Firebox plates, thickness	3/8 in. and 5/16 in.
Firebox, water space	5 in.	5 in.
Tubes, number and outside diameter	244-2 1/4 in.	237-2 1/4 in.
Tubes and flues, length	48-5 1/2 in.	40-5 1/2 in.
Heating surface, tubes and flues	19 ft.	19 ft.
Heating surface, firebox	4,043 sq. ft.	3,747 sq. ft.
Heating surface, total	272 sq. ft.	288 sq. ft.
Superheater heating surface	4,315 sq. ft.	4,035 sq. ft.
Equivalent heating surface†	1,300 sq. ft.	1,159 sq. ft.
Grate area	6,355 sq. ft.	5,766 sq. ft.
Grate area	70 sq. ft.	70 sq. ft.
Tender		
Tank	Water bottom	Water bottom
Weight	182,000 lb.	138,000 lb.
Wheels, diameter	33 in.	36 in.
Journals, diameter and length	6 in. by 11 in.	5 1/2 in. by 10 in.
Water capacity	9,000 gal.	7,000 gal.
Coal capacity	17 1/2 tons	12 1/2 tons

* Actual at 7.2 miles per hour.
 † Equivalent heating surface = total evaporative heating surface + 1.5 times the superheating surface.

The driving wheels are 62 in. in diameter. The front and rear tires are flanged and are 5 1/2 in. wide. The intermediate tires are all flangeless, those of the main wheels being 8 1/2 in. wide, while those of the second and fourth wheels are 7 1/2 in. wide. The locomotive is designed to operate on tracks having a minimum radius of curvature of 350 ft. In the connection between the engine and tender, the old style double safety bars with slotted holes have been replaced with a single safety bar which is of the same

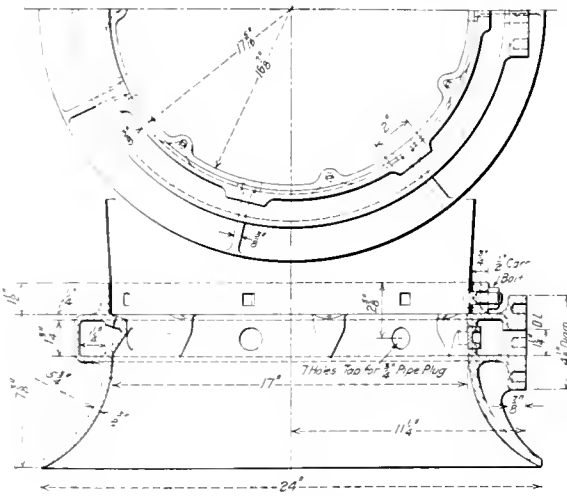

Ring Blower in Base of the Lift Pipe

cross section as the drawbar and 1 1/2 in. longer. It is placed immediately under the drawbar, being connected to the engine and tender by the drawbar pins.

The driver brakes are operated by two 18-in. air cylinders with 13-in. stroke which exert a braking power of 230,000 lb. The arrangement is similar to that described in connection with the class L-1-s Mikados.

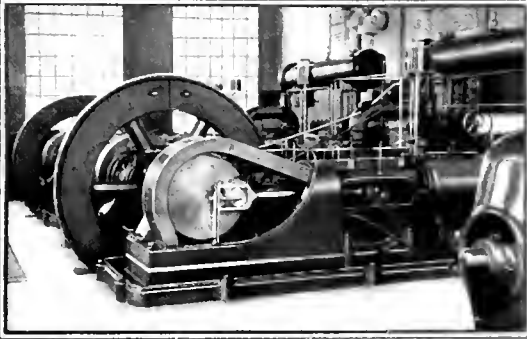

BY V. T. KROPIDLOWSKI

POWER HOUSE ECONOMICS

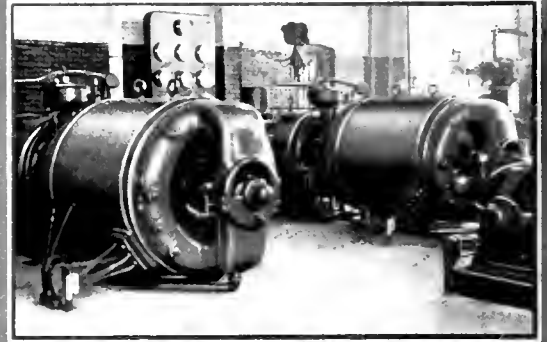

MECHANICAL AND ELECTRIC TRANSMISSION LOSSES

TABLE I has been compiled from a report of a test conducted in an eastern locomotive repair shop, having a capacity of about 30 repaired locomotives per month, which may be considered as typical of the majority of railway shops in the country. The test was conducted by representatives of the Westinghouse Electric & Manufacturing Company for the purpose of ascertaining the amount of power used by various tools when operating in regular routine work, and at the same time the power lost by shafting and belting in a group driven system. The machine tools are divided into six groups, the motor for the first group being rated at 40 hp., that for the second being rated at 30 hp., the third at 30 hp., the fourth at 20 hp., the fifth at 10 hp. and the sixth at 40 hp., counting consecutively from left to right in the table. The total horsepower lost from shafting and belt friction was 12 hp., and the average total power developed during the

test is to be found in a mechanically driven shop. That is true, but it must be remembered that in the case of the individual motor drive there are many more motors and they are of a smaller size. Their efficiency is therefore less than that of the large motors used in group drives, and it will be found that the increased electrical losses offset the small gain realized from the reduction in shafting and belt friction. Furthermore, the fixed charges upon the investment will be greater in the case of individual drive, because of the greater first cost of the motors and wiring. This statement is corroborated by the following quotation from an article by Charles H. Benjamin which appeared in the *Engineer* a few years ago: "Experiments made under my direction on several group installations in machine shops have shown a loss of from 40 to 60 per cent of the total power of the engine before reaching the machine." He says further on: "Direct tests on 16 large machines driven by independent motors in a locomotive works showed an average of 8.85 hp. for the machine and its work, and 2.35 hp. for the power consumed by the motor and countershafting." This means an efficiency of less than 80 per cent for the motors.

TABLE I—POWER TO DRIVE LINE AND COUNTER SHAFTS.

	Wheel section	Boiler section	Lathe section	Tool section	Flue section	Smith Shop section
Line shaft.....	2 1/2"x200'	2 1/2"x170'	2 1/2"x180'	2 1/2"x140'	2 1/2"x90'	2 1/2"x75'
Revolutions of shaft...	160	158	155	155	100	100
No. of hangers.....	26	19	22	20	10	9
No. of countershafts...	15	11	22	17	4	10
Power to drive line shaft, countershaft belts off.....	?	0.3 hp.	0.7 hp.	?	.35 hp.	5 hp.
Power to drive line and countershafts....	1.5 hp.	2 hp.	4.1 hp.	2.8 hp.	.6 hp.	1 hp.

Total friction horsepower, not including motor losses = 12 hp.
Average friction power developed in 10 hours = 74 hp.
Total power lost = 16 per cent., not including motor losses

10-hour day on which the test was conducted was 74 hp. The loss was therefore 16 per cent. This does not include the motor losses, as the results of the test are given in brake horsepower. No one will deny that the efficiency of electric motors is not much over 80 per cent; therefore we find that the shop in question sustains a total power loss, not including the generator and prime mover loss, of 36 per cent. The shaft hangers were all provided with roller bearings.

No doubt some reader will consider this unfair to the electric drive because in a group drive there still remains practically the same complement of belting and shafting which

An opportunity to determine the loss of power in a purely mechanical drive was afforded by an incident which occurred in a western locomotive shop of about the same capacity as the eastern shop previously referred to. For some reason the boiler pressure went down to six pounds gage and the shop had to be closed for a half day. During this time a round-house man came in and wanted a thread cut on a rod bolt. It was decided to attempt to run the shop on the six pounds steam pressure long enough to do the work required. The engine started the entire line shaft and all the countershafts and developed full speed. The line shaft is 310 ft. long, 3 in. in diameter and has 38 babbitted hangers, on the line shaft are mounted 87 pulleys connected to 40 countershafts. The engine driving the shop has 16-in. by 24-in. cylinders and runs at 90 r. p. m. If we allow for a five per cent loss between the boilers and engine and three per cent due to back pressure, the engine cutting off at 3/4 stroke, the mean effective pressure on the piston was 5.16 lb. The horsepower developed in driving all the shafting was

$$5.16 \times 201 \times 2 \times 180 = 11.4 \text{ hp.}$$

As the average horse-

power developed in this shop is approximately 100, the total

*The first of Mr. Kropidowski's articles on this subject appeared in the May issue on page 243.

loss, including that in the engine, was 11.4 per cent. It might be well to cite another case of direct belt drive. In a New England spinning mill a test was made to ascertain the friction losses, by stopping all of the machines and running only the shafting and belts on idle pulleys. This was found to be 418 hp., the average horsepower developed in the mill being 1,744 and the total loss, including engine losses, 24 per cent. It is a known fact that spinning mills are wasteful of power because of the great number of countershafts required.

POWER PRODUCTION COSTS

There is no reason why the generating equipment in an industrial plant of fair size should not be operated as efficiently as that of the central station, so called. Statistics of different public service commissions uphold this opinion. From a semi-annual report of the New York Edison Company the following data is available:

Total output	120,000,000 kw. hrs.
Total income	\$7,231,602.62
Total station expenses	\$1,318,570.21
Distribution expenses	1,210,108.84
General expenses	704,403.71
Taxes	402,942.21
Amortization	916,024.11
Uncollectible bills	92,860.08
Total expenses	\$4,644,906.16
Total expenses per kw. hr.	3.87 cents
Station expenses per kw. hr.	1.01 "
Average income per kw. hr.	6.02 "

The following cost data is taken from the report of the chief engineer of the Fitchburg Yarn Company:

Average horsepower throughout year	1,744
Coal per horsepower-year 4,225 lb. at \$4.50 per ton.....	\$ 8.46
Labor	2.92
Supplies and repairs	1.11
Total operating cost	\$12.49
Depreciation and interest	\$4.01
Taxes	0.72
Insurance	0.04
Total fixed charges	\$ 4.77
Total gross cost	\$17.26
Deduct cost of heating58
Total cost one hp. per year.....	\$16.68
Cost per hp. hour	0.55 cents
Cost per kw. hour	0.73 cents

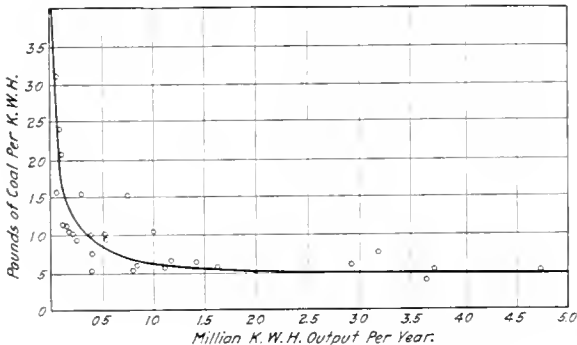

Fig. 1—Average Coal Consumed per Kilowatt Hour, Class "B" Electric Utilities, for the Period from June 30, 1908, to June 30, 1911

This industrial plant is, of course, a very economical plant, nevertheless, the figures present a great contrast with those of the central station just cited. The central station has to contend with greater fixed and general expenses. For instance, from a report of the Public Service Commission of the state of New York, a large central station in New York City is shown as having an operating expense of but 26½ per cent of the total cost of production, the remaining 73½ per cent being made up of overhead and distribution charges. This same company is capitalized at over \$440 per kilowatt of rated capacity, where a fair sized industrial plant can usually be installed for from \$65 to \$100 per kilowatt of capacity.

By referring to Fig. 1, which is taken from the Wisconsin Railroad Commission's report for the year 1914, it will be seen that a plant of 1,000,000 kw. hrs. output per year, which is equivalent to approximately 300 kw. installed capacity, is practically as economical in fuel consumption as the plant producing 4,500,000 kw. hrs. per year. This indicates that within certain limits there is not much variation in the efficiency of the machinery and personnel of a large or small plant.

RATES AND COST OF PRODUCTION

The question is often asked how some of the public utilities are able to sell electricity in bulk for less than it costs to produce it, as they evidently must, in some cases, if

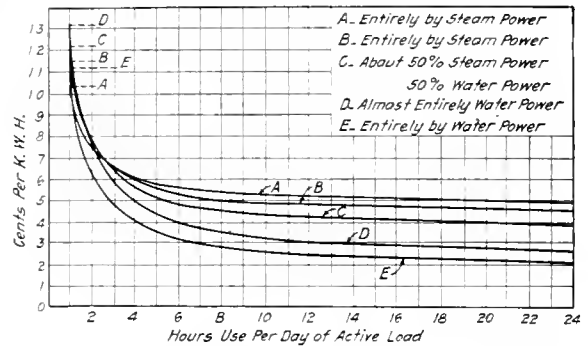

Fig. 2—Cost Curves for Commercial Electric Lighting

they sell it for 1½ cents per kw. hr. The answer is that the maximum rate customers make up the deficit.

The writer once overheard a conversation between two men, one complaining regarding the cost of light in his house, the other evidently an officer of one of the large power producing companies. The latter told the complainant that his company did not care for the small users, as they cost more than they return and that the profit was made from the big users of power; those paying the low rate. An examination of the conditions seems to refute this. By referring to Fig. 3 it will be seen that if a company has a 12-cent maximum rate, and if the maximum rate customers comprise 10 per cent of the total patronage and if the company's production costs are such as to require an income of 5.95 cents per kw. hr. for a profit, the remainder of the customers will have to pay 5.3 cents per kw. hr. If 40 per cent of the power was sold at 12 cents, the remaining 60 per cent would need to pay but two cents. Again, if the maximum rate is 15 cents per kw. hr. and 40 per cent of the customers paid that rate, the remaining 60 per cent would need to pay the small sum of but ½ cent per kw. hr. to make up the necessary average income of 5.95 cents per kw. hr.

This shows conclusively that the small consumers, or those paying the maximum rate, were the ones most desired. To bring out this fact still more forcibly, Table II has been compiled from the report of the Wisconsin Railroad Commission for 1914, referring to a certain large power producing concern in that state. It will be noted that the company in question sustained a loss of 1.49 cents per kw. hr., as shown in column (2), which is due to the heavy fixed charge of 1.86 cents per kw. hr. According to this statement, it would seem that the company could not exist and it could not if it were not for the fact that all the company's lighting business is outside of the state of Wisconsin, while, of course, the Wisconsin commission only accounts for the business done in that state. Table III shows that 94.25 per cent of the company's business in the state of Wisconsin is bulk sales to other utilities. It further will be noted by referring to Table II, column (1),

that the fixed charges, including depreciation, taxes and interest on funded debt amount to 172.10 per cent of the operating revenue, the interest on funded debt alone amounting to 139.89 per cent, which shows that the company is highly capitalized.

TABLE II—ANALYSIS OF REVENUES AND EXPENSES OF A WISCONSIN POWER COMPANY.

	Analysis of Income Account, Per Cent	Analysis of Income Per. Kw. Hr. Sold, Cents	Analysis of Different Classes of Expense, Per Cent
Operating revenue	100.00	1.33
Operating and maintenance expense..	42.06	.56	19.05
Depreciation	10.00	.13	4.67
Taxes	22.23	.30	10.38
Interest on funded debt and mortgages	139.87	1.86	65.30
Non-operating revenue	1.96	.03
Deficit	112.20	1.49
		Total expense	100.00

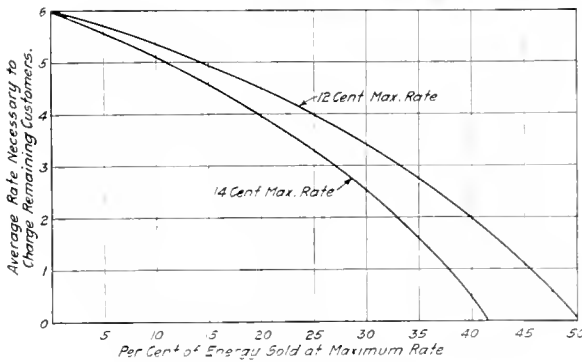

Fig. 3—Average Minimum Rates at Which Power Can be Sold to Large Users

TABLE III—PERCENTAGE ANALYSIS OF SOURCES OF REVENUE OF THE COMPANY REFERRED TO IN TABLE II.

Commercial lighting	3.41 per cent
Municipal lighting92 per cent
Commercial power	1.22 per cent
Bulk sales to other utilities.....	94.25 per cent
Miscellaneous earnings20 per cent
Total operating revenue	100.00 per cent

Fig. 2 has also been taken from the Wisconsin commission's report and shows cost of generation of all the electric companies operating in Wisconsin, at various load factors. It shows the lowest cost to be two cents at 100 per cent load factor. This condition, however, is not attained by any company, 75 per cent being exceptional and the average being 30 per cent.

EXHAUST STEAM HEATING

The diagram in Fig. 4 has been constructed from data obtained by a company engaged in the steam heating business. This diagram enables one to tell at a glance the percentage increase in coal consumption per hp. hr. resulting from various increases in back pressure. It will be seen that at five pounds back pressure, which is the most that need be carried on any well laid out heating system of moderate size, the increased coal consumption per hp. hr. equals 10 per cent. If an engine consumes 34 lb. of steam per hp. hr. and 90 per cent of that steam is available for heating after passing through the engine, 30.6 lb. of steam per hp. hr. will be available for heating. If a horsepower is produced on five pounds of coal with no back pressure, with five pounds back pressure it will require 1/2 lb. more coal per hour. Each square foot of radiating surface will require 0.3 lb. of steam per hour under ordinary conditions. Each horsepower developed will therefore take care of 30.6 ÷ 0.3, or 102 sq. ft. of radiating surface. As each hp. hr.

requires 1/2 lb. additional coal due to the back pressure, each square foot of radiating surface will be chargeable with 0.5 ÷ 102 = .005 lb. of coal per hr. Therefore, if a shop requires 6,000 sq. ft. of radiating surface and the required amount of exhaust steam is available 24 hrs. a day for 30 days a month, the shop will be heated with

$$\frac{6,000 \times .005 \times 24 \times 30}{2,000} = 10.8$$

tons of coal per month. If that amount of radiation can be supplied with 20 times 10.8 tons of coal applied directly to the heating system it will indicate an exceptionally good performance. Of course, the above figures are based on the assumption that exhaust steam is available continuously, a condition which seldom exists in practice. As far as the exhaust steam is available, however, these results may be obtained, and it is evident that the claim that the back pressure imposed on the engine by the steam heat system neutralizes the saving from the use of the exhaust steam, is entirely unjustified.

TRANSMISSION OF STEAM AND ELECTRICITY

There has not been much discussion on the comparative cost of steam and electric transmission, probably due to the fact that the advantages of electricity over steam when conveyed any appreciable distance is so evident that it needs no discussion. There are many cases, however, where steam is conveyed for distances of several hundred feet to isolated power units about the shop, and it may be worth while to arrive at the relation of the two systems of transmission under such conditions. Supposing we have an engine developing an average of 25 hp. at a distance from the source of steam supply of 500 ft., which is not an uncommon condition. For this distance a 3-in. pipe will be required, having a radiating surface of approximately 500 sq. ft. According to George H. Bann's experiments, at 150-lb. steam pressure this pipe will condense, if not insulated, 1.16 lb. of steam per sq. ft. of surface per hour, or 580 lb. of steam per hour. If the engine uses 40 lb. of steam

per hp. hr. the loss will be $\frac{580}{25 \times 40} = 58$ per cent. Usually, however, high pressure steam pipes are insulated, and in this case, with the very best pipe covering the condensa-

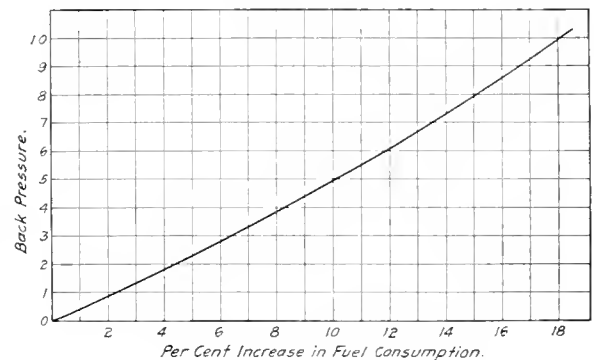
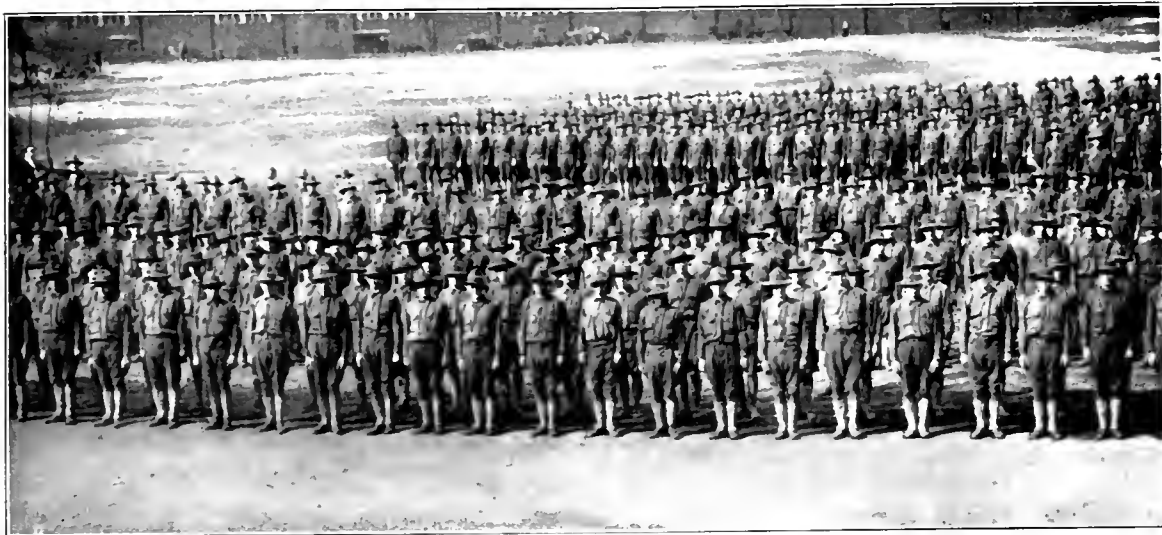

Fig. 4—Calculated Additional Fuel Consumption Due to Back Pressure from Heating System, Based on 45 lb. M.E.P.

tion would be reduced about 75 per cent, bringing the loss down to 14.5 per cent. If an electric motor were used under the same conditions there would be a line drop of about three per cent. Furthermore, 500 ft. of 3-in. pipe, not including fixtures or labor for installing, will cost about \$121. A 500-ft. three-phase electric line, for the wire alone, will cost about \$86. Furthermore, electric motors are much more economical than small steam engines.



The Ninth Engineers on Parade

THE NINTH REGIMENT OF ENGINEERS

The Railway Shop Regiment Now in Camp at Philadelphia Awaits Orders to Sail for France

BY OUR SPECIAL MILITARY OBSERVER

THE Ninth Engineers of the National Army mobilizing to full war strength are now in camp in the Commercial Museum at Philadelphia nearly 1,200 strong. They are putting on the finishing touches preparatory to their starting for France in the near future to help the French repair and maintain locomotives for use behind the front. The men are picked men from the locomotive repair forces of many of the railway shops between New York, Philadelphia, Baltimore and Pittsburgh. They are under the command of a regular army colonel and of majors, captains and lieutenants who were formerly mechanical department officers and nearly all of whom are college men and have had a month or more of intensive military training at Plattsburg or Fort Niagara.

About the middle of May, W. W. Atterbury, vice-president of the Pennsylvania Railroad, received a request from Samuel M. Felton to assist in the raising of a regiment of shop men for service in France. Mr. Atterbury promptly assigned to this work James Milliken, special engineer, and formerly superintendent of motive power of the Pennsylvania at Wilmington. Mr. Milliken and his staff entered upon the new duties with a snap and vim, and results began to come in promptly. First, they took three typical shops on the Pennsylvania system, averaged the number of blacksmiths, boiler shop, erecting shop and machine shop employees, etc., and reduced the figures to the basis of 1,000 men. Then they got in touch with the Bureau of Railway Economics at Washington, and obtained the number of motive power employees on each of the roads in the Eastern territory. With this as a basis they assigned a quota to each road in the territory and asked for double that number, so as to take care of rejections of one kind and another.

Mr. Milliken himself took charge of the recruiting on the Pennsylvania, and with such effectiveness that the road raised 40 per cent of the regiment instead of its assigned 30 per cent. First, he called a meeting of the general super-

intendents, and told them that each division had been assigned to raise a certain number of blacksmiths, boiler makers, etc. He told them to emphasize in calling for volunteers that the men were to go to France to repair locomotives, that while as soldiers they might be called upon to work hard, they would still be engaged on work with which they were familiar, and that they would not be called upon to go into the trenches as infantry. The superintendents fell in with the idea at once. The very next day no less than 76 men reported from Trenton; faster than the examiners could take care of them. The entire quota of 30 per cent was filled in 10 days, or before June 1. By June 20 the entire regiment of 1,098 officers and men was complete, and the officers had been selected. The regiment has since been asked to raise an additional 10 per cent of enlisted men—104 more. It still lacks some of these, particularly blacksmiths and boiler makers.

Each man as he presented himself was given a careful physical examination and was quizzed as to his qualifications by William A. Herbert, assistant enginehouse foreman at West Philadelphia. The regiment consists of an exceptionally fine body of clean-minded and physically fit men, every one of which has a trade and a desire to do big things. The officers are 100 per cent enthusiastic over them.

It is interesting to see what kind of skilled mechanics were secured. The following list will show how the trades are divided:

STATEMENT SHOWING BY TRADES THE MAKE-UP OF THE LOCOMOTIVE SHOP REGIMENT.	
COMMANDING OFFICERS	37
MEDICAL MEN	23
MASTER MECHANICS AND SHOP OFFICERS	120
Storeroom attendants	18
Draftsmen	11
Stenographers	20
Shop clerks	6
Storeroom clerks	5
Clerks	58
Telegraph operators	2
	126



BLACKSMITH SHOP	126	Battery men	2
Blacksmiths	43	Electrician helpers	4
Forgemen	4	Stationary engineers	4
Spring makers	8	Stationary firemen	8
Tool dressers	8	Derrick engineers	28
Furnace heaters	4		
Forging machine men	10	TIN SHOP	20
Steam hammer operators	5	Tinsmiths	4
Blacksmith helpers	44	Lamp makers	4
		Sheet iron workers	8
BOILER SHOP	126	Tin shop helpers	8
General boilermakers	39		20
Flangers	4	PAINT SHOP	11
Layout table and template men	4	Locomotive painters	7
Flue men	17	Stripers and letterers	4
Riveters	16		11
Boilermaker helpers	35	CHAUFFEURS	38
Boiler shop machinists	13	Chauffeurs	30
	128	Auto. engine men	4
ERECTING SHOP	163	Auto. electrical men	4
General erecting shop men	24		38
Valve setters	13	MISCELLANEOUS	144
Cylinder and guide men	8	Laborers	86
Driving box men	8	Locomotive hostlers	2
Spring rigging men	8	Brick layer	1
Truck men	17	Rigger	1
Frame men	7	Chemist	1
Cab fitters	8	Cooks	27
Throttle and dry pipe men	8	Buglers	23
Air brake men	16	Barbers	7
Grate and ash pan men	8	Tailors	7
Erecting shop helpers	32	Photographers	7
Crane operators	7		144
	163	Grand Total	1 698
MACHINE SHOP	162		
General machine shop hands	24		
Engine lathe hands	16		
Turret lathe hands	16		
Axis lathe hands	4		
Boring mill hands	10		
Milling machine hands	6		
Shaper hands	6		
Placer hands	6		
Slotter hands	5		
Drill press hands	9		
Tool makers	10		
Vise hands	27		
Air pump men	8		
Triple valve men	8		
Injector repairers	5		
	162		
TENDER AND CAR REPAIRMEN	40		
Cistern repairmen	8		
Truck repairmen	16		
Locomotive cab builders	6		
Cabinet makers	2		
General wood workers	4		
Wood work machine hands	4		
	40		
PIPE SHOP	58		
Pipe fitters	17		
Plumbers	5		
Coppersmiths	5		
Copper and brass braziers	5		
Pipe fitter helpers	23		
Coppersmith helpers	5		
	58		
ELECTRICIANS	28		
General electricians	2		
Linemen	4		

The men in the regiment serve with the same ranks and pay as if they were in the Regular Army. The corporals, as a rule, were gang leaders, the sergeants, gang foremen and commissioned officers, motive power department officers.

The men were divided among the six companies as they reported, but by the time this will have appeared in print they will have been rearranged in so far as possible by trades. The assignment of companies, divisions of work and officers will then be as follows:

40 Colonel, Herbert D. Deakyne; lieutenant-colonel, H. H. Maxfield, superintendent, motive power of the Pennsylvania Railroad, at New York; captain, adjutant, William F. Tompkins, a West Point man; captain, quartermaster, C. R. Rogers, a contractor from Corry, Pa.; captain engineer, Van R. C. King, district superintendent, Atlantic Coast Line, Wilmington, N. C.

58 *First Battalion*—Major, Charles D. Barret, master mechanic, Pennsylvania Railroad, Sunbury, Pa.

Company A—Erecting shop and enginehouse—Captain, J. McDonough, assistant shop superintendent, Baltimore & Ohio, Baltimore, Md.; first lieutenants, F. V. DeHaven, Pennsylvania Lines, West, and C. K. Steins, special ap-

prentice, Pennsylvania; second lieutenant, Don C. Minick, Pennsylvania Lines West.

Company B—Tender, cab and tank shop—Captain, G. T. Huff, Jr., assistant road foreman, Pennsylvania; first lieutenants, R. R. Meigs, a consulting engineer, at Philadelphia, and W. H. Stevens, also a consulting engineer, from Philadelphia; second lieutenant, McClure Fahnestock, motive power inspector, Pennsylvania, at Pittsburgh.

Company C—Boiler shop—Captain, G. W. Butts; first lieutenants, F. R. Fitzpatrick, Locomotive Superheater Company, New York, and T. L. Mallam, boiler shop foreman, Pennsylvania, Trenton, N. J.; second lieutenant, E. D. Hagerly, storekeeper, Pennsylvania, at Verona.

Second Battalion—Major, C. S. Gaskill, master mechanic, Pennsylvania, Baltimore, Md.

Company D—Machine shop—Captain, F. S. Robbins, assistant master mechanic, Pennsylvania, Pittsburgh, Pa.; first lieutenants, J. J. McGuire, master mechanic, Baltimore & Ohio, at Newcastle, and C. G. Boffemmyer, test department, Pennsylvania, Altoona; second lieutenant, A. G. Moler, Philadelphia.

Company E—Electricians (power plants) and shop con-

pox vaccination. Some of the men keel over; some have arms as sore as boils, and the inoculations aren't over yet.

Y. M. C. A. WORK

No military camp could ever be complete in these modern times without its Y. M. C. A. The camp of the Ninth Engineers is no exception. The moment the Commercial Museum was occupied, the Pennsylvania Railroad Y. M. C. A. brought in writing tables, chairs, pens, ink and stationery, and started work. It has printed special letterheads, and envelopes marked "Correspondence Table, Ninth Regiment Engineers." It has brought in a piano, a victrola, magazines and books, and its efforts have been duly repaid.

William A. Patton, assistant to President Rea, is in general charge of the work, and J. Frank Keebler is the man-on-the-job. They have arranged entertainments once or twice a week, and now and again they have secured a speaker, who talks to the boys on questions of interest. Realizing that Americans are not strong, linguistically, they have secured five French instructors, and the boys have been given an opportunity to learn the language free of charge.

The Pennsylvania Railroad Women's Division for War Relief will supply each member of the regiment with a

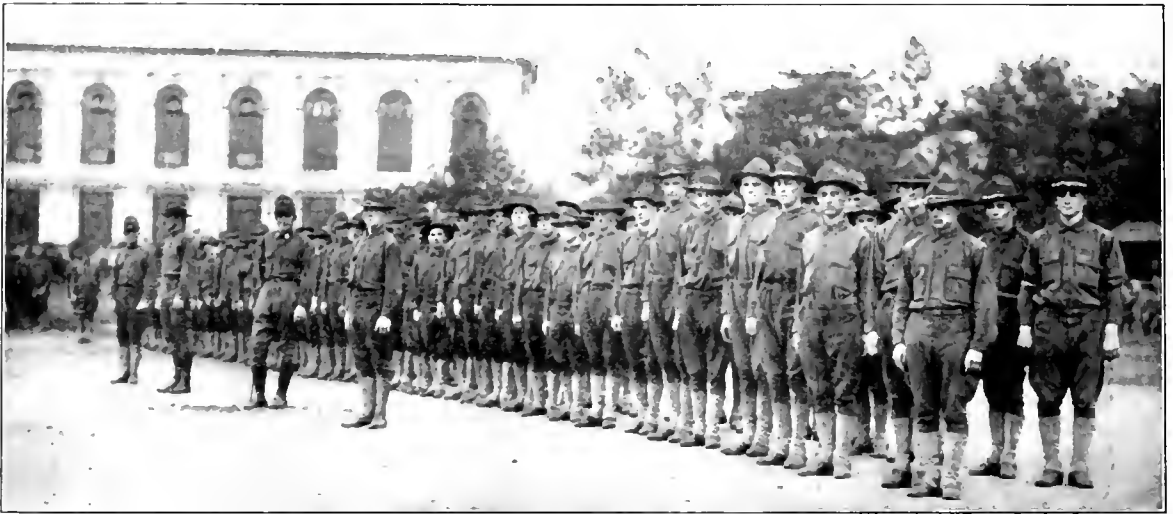

Some of the Pennsylvania Railroad Men in the Ninth Regiment

struction—Captain, B. W. Kline, electrician, Pennsylvania, Williamsport; first lieutenants, Alba B. Johnson, Jr., Baldwin Locomotive Works, and William Welch, blacksmith shop foreman, Pennsylvania, Meadow Shops; second lieutenant, Charles G. Brown, Altoona shops.

Company F—Pipe and tin shop—Captain, E. B. Whitman, assistant road foreman, Pennsylvania, Pittsburgh; first lieutenants, W. B. Rudd, assistant road foreman, Pennsylvania, Jersey City, and F. A. Wightman, motive power inspector, Pennsylvania, New York; second lieutenant, J. G. Shaeffer, special apprentice, Pennsylvania, Altoona.

The men are now quartered in the big hall of the Commercial Museum, with accommodations, incidentally, that would make a fellow who had been to Plattsburg or to the border, green with envy. They have shower baths with hot and cold water—over 60 of them—and with 30 real Ruud heaters. They drill on Franklin Field or on a big parade ground outside the museum, and when drill is over, have a chance at the swimming pool on the university grounds.

The men drill for four drill periods of an hour, daily. They already march like fit soldiers. Our observer knows, he saw one of the companies doing it on Franklin Field. The men have only one kick. That's about the typhoid inoculations: Three paratyphoid, three typhoid and a small-

comfort kit, and some of these have already been sent to the regiment from all sources.

THE BAND

And the Pennsylvania Railroad furnished the instruments for a band—a 31-piece band, that was able to play "The Star-Spangled Banner" three days after they got the men together. The band is pretty strong on many other patriotic tunes by this time, and there is a rumor—it's only a rumor—that the regiment is going to have a special song, presumably for the band to play, and that its composers are going to be Irving Berlin and George M. Cohan. But more of that when we hear the words and music.

But to be serious again, the regiment is looking forward to some good hard work across the sea. Just where it will go—that is, to what French railway shops—the men don't know as yet, and if they did, they wouldn't tell anyway. But they are prepared for anything. They will carry many of their own tools; they also have 12 Pierce-Arrow trucks.

The Pennsylvania Railroad is proud of the regiment; and it has a good right to be. Mr. Atterbury, particularly, is taking a keen interest in its success. He has visited the regiment on a number of occasions and has expressed the hope that he may present the regiment with its colors.

PENNSYLVANIA ELECTRIC LOCOMOTIVE

Experimental Design for Heavy Trunk Line Service
to Operate Over 24 Miles of One Per Cent Grade

THE Pennsylvania has designed and built an experimental electric locomotive which is to be used ultimately to handle tonnage trains over the grade west of Altoona, Pa. This section includes the Horseshoe Curve and consists of a 2 per cent grade 12 miles long between Altoona and Gallitzin, the summit of the grade, on the eastern slope, and a one per cent grade 24 miles long from Gallitzin to Johnstown, Pa., on the western slope. This locomotive was built for the purpose of carefully developing a standard unit before going ahead with the production of the number of units

doing excites the secondary of the transformer from which the phase converter is operated. This phase converter changes the single phase current supplied to it by the transformer to three-phase current for the use of the traction motors. These motors, of which there are four, have a rating of 1,200 hp. each, giving the locomotive a capacity of 4,800 hp.

The three-phase current taken from the phase converter is supplied, through the necessary control switches, to the primaries of these motors and the secondary current thus generated in the other windings of the motors is controlled

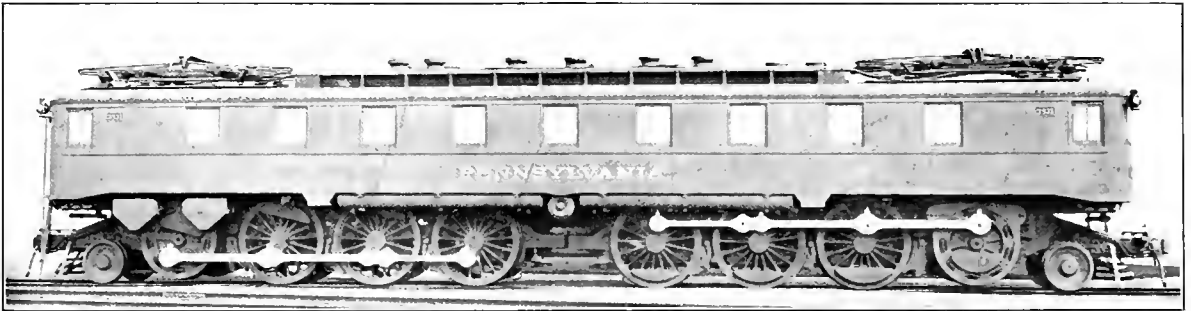

Fig. 1—Pennsylvania Electric Locomotive for Heavy Trunk Line Service on Two and One Percent Grades

required. In general the locomotive is somewhat similar to those used on the Elkhorn Grade electrification of the Norfolk & Western in that it uses three-phase motors, fed by a phase-converter connected to an 11,000-volt single-phase contact wire, it also uses the principle of transmitting the motor power to the drivers through regular standard side rods connected to a motor driven jack shaft.

Many of the important details, however, in the new locomotive are distinct departures from any previous design. The most unique feature of the locomotive is that instead of being made up of two cabs like those on the Norfolk & West-

by the motorman by means of water rheostats, thus permitting very close regulation of the tractive effort developed by the locomotive during acceleration.

The two motors which are mounted on each truck frame are geared to a jack shaft driving the driving wheels through connecting rods and the springs in the gears of these jack shafts are so adjusted as to give the effect of a solid gear up to a tractive effort equivalent to 25 per cent of the weight on drivers. Therefore, under all ordinary conditions the effect of a solid gear is obtained.

The locomotive has two operating speeds with possibilities

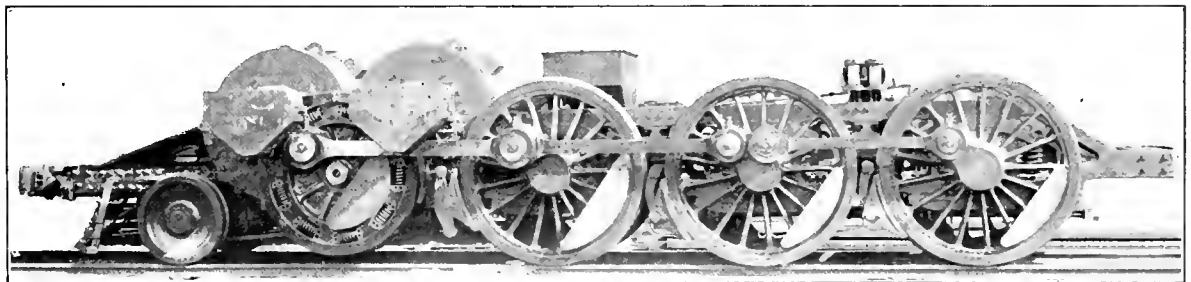

Fig. 2—One of the Driving Trucks for the Pennsylvania Electric Locomotive Showing Motor and Spring Gear Jack Shaft

ern and the St. Paul, it consists of only one cab which rides on two articulated six-wheel driving trucks.

The locomotive is to be given a preliminary trial on the Philadelphia-Paoli 11,000-volt electrification of the Pennsylvania.

The locomotive is designed to operate on 11,000 volts, single-phase, 25-cycle current taken from an overhead contact wire. The current is supplied to the primary of a static transformer which returns it to the track circuit and in so

operating at any intermediate speed from zero to the maximum, by means of the rheostatic connections. The lowest of these speeds is 10.5 m. p. h. and is obtained by connecting the motors on either truck in cascade with each other and in parallel with those on the other truck. It is contemplated to use this speed only in slow movements and around yards. The other speed of 20.6 m. p. h. is obtained by connecting the motors on both trucks in parallel and this is the speed at which the locomotive is designed to operate in

road service and at which it gives a tractive effort of 87,200 lb.

The cab containing the electrical machinery is 72 ft. 6 in. long and 10 ft. wide over sheathing. It has two Z-shaped center girders 26 in. deep, made of plates and angles covered on top with a plate 6 ft. 1 1/8 in. wide, which forms the platform floor to which the electrical machinery is attached. The side framing is of the same type as on Pennsylvania passenger cars, consisting of U-shaped posts bent at the top to support the lower roof deck and sheathed with 1/8-in. plates. The upper deck extends only over the central part of the cab for a length of 36 ft. 9 in., leaving a space at each end of cab for the pantographs.

To permit removal and replacing of electrical machinery the roof of the upper deck is removable and the turtle back decks at each end of cab are equipped with large hatches. No lining is provided for the body of the cab, but the motorman's ends, which are separated from the main cab by partitions, are lined and insulated and provided with a resilient floor covering. For the protection of the motorman the ends of the cab are also provided with strong vertical members, similar to those used in Pennsylvania steel passenger and postal cars. Both sides for the full length of the upper deck are made in the form of louvres to provide for ventilation.

Each truck is a motor truck, which receives power from two motors through a spring wheel on each side, mounted on a jack shaft. Each gear wheel is connected to the three drivers by the usual side rods and the remainder of the drive and running gear is similar to those used for steam locomotives. The spring gear for each truck is of the three point suspension type, one point being over the pony truck and the other two points over each frame, consisting of equalizers over each box, elliptical springs between jour-

fore are solid bronze forced into a circular opening in the frame casting.

The center plate is located halfway between the first and second axles at an elevation of about the height of the top of the frames. Between the second and third axles an auxiliary spring support has been applied for the purpose of equalizing the loads on the various drivers, which will counterbalance the excess weight due to the location of motors between the pony truck and the first pair of drivers. The contact between the caps over these springs and the bottom surface of the cab must necessarily be a sliding contact.

Each motor truck includes a pony truck of the Pennsylvania Railroad type, with an elliptic spring located each

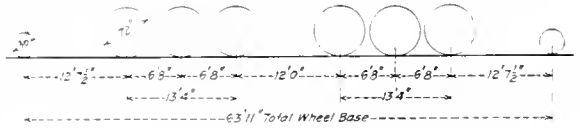

Fig. 4—Wheel Arrangement of the Pennsylvania Electric Locomotive

side of the axle and supported on T-links. As the usual T-links alone will not provide sufficient lateral motion, a rocker casting supported by the elliptic springs has been added. The combination T-links and rocker permit sufficient lateral motion for curves of 275 ft. radius. The articulation between the motor trucks is of a construction similar to a pedestal attached to the cab center sills. The lower ends of the pedestal legs are connected together with a tie bar. This permits each truck to rotate around the center of the center plate without restriction. All bearing surfaces in the articulation are plated with manganese steel. The pulling and pushing strains between drawbars carry through the trucks and articulation in a direct plane 3 1/2 in. above the rails so that the cab is entirely relieved of these strains.

The principal characteristics of the locomotive follows:

Railroad classification	FF1
Overall length	76 ft. 6 3/4 in.
Total wheelbase	63 ft. 11 in.
Driving wheelbase	38 ft. 8 in.
Rigid wheelbase	13 ft. 4 in.
Height from rail to locked position of pantagraph	15 ft. 6 in.
Height from rail to top of cab	14 ft. 8 in.
Width over cab body	10 ft. 0 in.
Overall width	10 ft. 1 in.
Diameter of driving wheels	72 in.
Diameter of pony wheels	36 in.
Weight on drivers	198 tons
Number of driving axles	6
Weight of each pony truck	21 tons
Total weight of locomotive	240 tons
Voltage of locomotive	11,000
Tractive effort at hourly rating of motors	87,200 lb.
Speed	20.6 m.p.h.
Capacity of locomotive—one-hour rating	4,800 h.p.

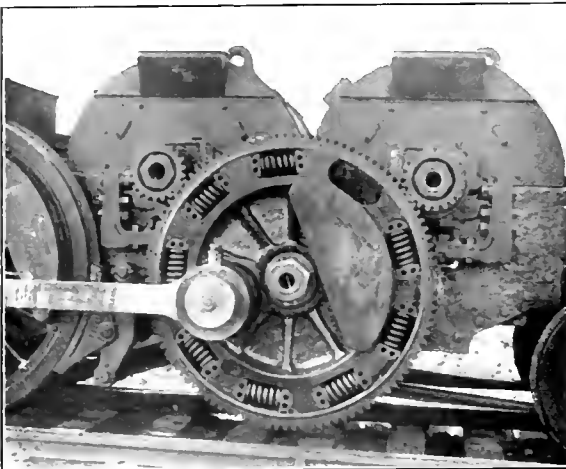

Fig. 3—A View of the Jack Shaft With Its Spring Gear

nals and helical springs outside of the first and third journals.

Brake shoes are provided for one side of each driver, the brake arrangement being of the usual steam locomotive type with two cylinders, each 16 in. in diameter and located between the frames between the second and third axles. The train brake and locomotive brake can each be operated independent of the other. Above the frames and between the first pair of drivers is located a sand box with sand pipes leading to the front of the first pair of drivers and to the rear of the third pair of drivers, and equipped with Leach double "E" sanders. The gear wheels have inward projections forming the jack shaft journals. The bearings there-

CARS AND LOCOMOTIVES ORDERED IN JUNE

Although June is usually a comparatively quiet month from the standpoint of equipment purchases, the purchases in June this year held up exceedingly well. The domestic purchases of locomotives were not large, but there were important purchases by foreign roads. The purchases of freight cars, however, were considerably larger than in the months immediately preceding. The purchases were as follows:

	Locomotives	Freight cars	Passenger cars
Domestic	64	11,945	2
Foreign	443	100	..

Among the important locomotive orders were the following:

Chicago & Alton	10 Mikado	Baldwin
Southern	25 Santa Fe	American
Russian Government	400 Narrow Gauge	America

The important freight car purchases included the following:

Atchison, Topeka & Santa Fe	500 Gondola	Am. C. & F.
Canadian Government Railways	5,000	Can. C. & F.
Illinois Central	75 Caboose	Co. shops
	250 Box	Co. shops
	250 Stock	Co. shops
Marianna Coal Co.	1,000 Coal	Cambridge
Missouri Pacific	500 Box	Co. shops
Norfolk & Western	2,000 Box	Co. shops
Pennsylvania	1,000 Box	Co. shops

NEW POWER FOR SOUTHERN RAILWAY

4-8-2 Type Weighs 314,800 lb., 2-10-2 Type 370,600 lb.,
Tractive Efforts 47,800 and 71,000 lb., Respectively

THE Southern Railway and its associated lines are now receiving from The Baldwin Locomotive Works 30 locomotives of the Mountain type for passenger service, and 55 locomotives of the Santa Fe type for freight service. These locomotives considerably exceed in weight and hauling capacity the designs heretofore used on this road, and they constitute a notable group of modern heavy power.

Of the Mountain type locomotives, 23 are for the

and switching service. In the present instance, the Ragonet power reverse mechanism is applied.

The firebox is placed entirely back of the driving-wheels, and has a combustion chamber 44 $\frac{3}{4}$ in. long. In order to provide a free entry to the throat under the combustion chamber, a conical ring is used in the middle of the barrel, increasing the shell diameter from 76 $\frac{1}{2}$ to 87 in. The equipment includes a Schmidt superheater, Security arch

Type	Cylinders, diameter and stroke	Diameter of drivers	Steam pressure, lb. per sq. in.	Grate area, sq. ft.	Water heating surface, sq. ft.	Superheating surface, sq. ft.	Weight on drivers, lb.	Weight total engine, lb.	Tractive effort, lb.
Pacific	24 in. by 28 in.	72 $\frac{1}{2}$ in.	185	54	3,058	660	141,500	232,300	35,000
Mountain	27 in. by 28 in.	69 in.	190	60.7	3,563	942	209,800	314,800	47,800
Mikado	27 in. by 30 in.	63 in.	175	53.3	3,198	699	213,700	272,940	51,700
Santa Fe	28 in. by 32 in.	57 in.	190	88	5,234	1,341	294,400	370,600	71,000

Southern Railway proper, while five are assigned to the Cincinnati, New Orleans and Texas Pacific, and two to the Alabama Great Southern. These engines replace Pacific type locomotives, a comparison of the two types being as shown in the table.

The figures clearly indicate the increased capacity of the new engines, which are able to handle heavy trains on schedule without forcing the maximum speeds above reason-

and power operated fire-door. The superheater flues are electrically welded into the back tube sheet.

The tender is carried on equalized pedestal trucks, and has a frame composed of 12-in. longitudinal channels, with white oak bumpers. The coal and water capacity are 12 tons and 9,000 gallons respectively.

The Santa Fe type locomotives are replacing Mikados, a large number of which have been built for the Southern

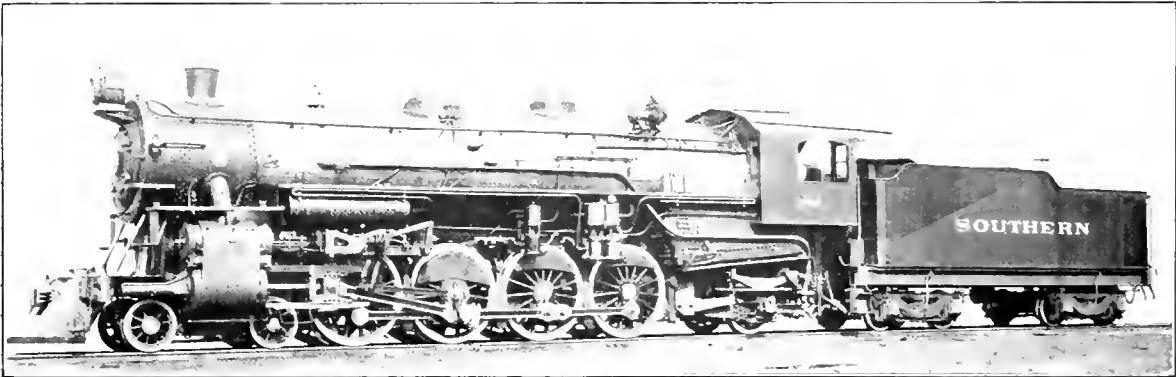

Mountain Type Locomotive for Passenger Service—Southern Railway

able limits. This means added safety in operation, and economy in the maintenance of track and equipment.

The four pairs of driving-wheels are equalized with the rear truck by a continuous equalization system on each side. The four-wheeled front truck is of the Economy constant resistance type. Long driving-boxes are used on the second, or main, pair of driving-wheels, and flanged tires are used throughout. Sufficient lateral play is allowed to permit the locomotives to traverse curves of 20 deg. Flange oilers are applied to the leading drivers.

The main frames are vanadium steel castings of most substantial construction, as they have a width of 6 in. and a depth over the pedestals of 6 $\frac{3}{4}$ in. The pedestal binders are of iron, and are held in place by three bolts at each end. The Commonwealth rear frame cradle is applied.

The steam distribution is controlled by 14-in. piston valves driven by the Southern valve motion, with which the railway has had an extensive experience, both in passenger, freight

Railway by The Baldwin Locomotive Works. A comparison of these two types is also shown in the table.

Comparing the Santa Fe type with the Mikado, it may be noted that while the increase in tractive force is 37 per cent (approximately the same as the increase in total weight and in weight on drivers), the increase in total equivalent heating surface is 71 per cent and in grate area 65 per cent. Provision has been made for fully utilizing the high boiler power of the Santa Fe type engines, as they are equipped with mechanical stokers. The Street stoker is applied to 50 engines, and the Hanna stoker to the remaining five. As in the case of the passenger locomotives, the fireboxes have combustion chambers and brick arches. The boiler has a straight top, but the third ring is sloped on the bottom to allow a sufficiently deep water space under the combustion chamber.

Running gear details include lateral motion driving-boxes on the front axle, long boxes on the third or main axle.

Economy front truck, and Hodges trailing truck. The swings of the trucks and the lateral play between rails and flanges are sufficient to permit the engine to traverse curves of 16 deg. The wheels of the third, or main pair have plain tires. Flange lubricators are applied to the front and rear driving-wheels.

As the doors in the front wall of the cab are necessarily very narrow, a running board is placed below the cab on each side, and hand holds are placed on the outside of the cab below the side windows, so that the men can easily reach the main running boards from the firing deck. To keep within the clearance limits, the bell is placed on the curve of the boiler at one side of the center, and there are four sandboxes, placed two right and two left.

The tenders are of the same capacity as those used with the passenger locomotives, and are similar in design, with the exception of such changes as are necessary on account of the application of stokers to the freight locomotives.

The tables contain further particulars of the locomotives:

General Data

	4-8-2	2-10-2
Gage	4 ft. 8 1/2 in.	4 ft. 8 1/2 in.
Service	Passenger	Freight
Fuel	Bit. coal	Bit. coal
Tractive effort	47,800 lb.	71,000 lb.
Weight in working order	314,800 lb.	370,600 lb.
Weight on drivers	209,800 lb.	294,300 lb.
Weight on leading truck	53,800 lb.	26,700 lb.
Weight on trailing truck	51,200 lb.	49,500 lb.
Weight of engine and tender in working order (approx.)	480,000 lb.	546,000 lb.
Wheel base, driving	18 ft.	20 ft. 7 in.
Wheel base, total	38 ft. 11 in.	38 ft. 8 in.
Wheel base, engine and tender	73 ft. 3 1/2 in.	74 ft. 9 1/2 in.

Ratios

Weight on drivers ÷ tractive effort	4.4	4.1
Total weight ÷ tractive effort	6.6	5.2
Tractive effort × diam. drivers ÷ equivalent heating surface*	649.1	543.5
Equivalent heating surface* ÷ grate area	76.2	84.6
Firebox heating surface ÷ equivalent heating surface*, per cent.	6.5	5.1
Weight on drivers ÷ equivalent heating surface*	41.3	39.5
Total weight ÷ equivalent heating sur-		

Engine truck, journals	6 in. by 12 in.	6 in. by 12 in.
Trailing truck wheels, diameter	42 in.	42 in.
Trailing truck, journals	8 in. by 14 in.	8 in. by 14 in.

Boiler

Style	Conical wagon-top	Straight top
Working pressure	190 lb. per sq. in.	190 lb. per sq. in.
Outside diameter of first ring	76 1/2 in.	88 1/2 in.
Firebox, length and width	114 1/2 in. by 84 1/2 in.	131 1/2 in. by 96 in.
Firebox plates, thickness	Sides, back and crown, 3/8 in.; tube, 5/8 in.	Sides, back and crown, 3/8 in.; tube, 5/8 in.
Firebox, water space	Front, 5 1/2 in.; sides and back, 5 in.	Front, 6 in.; sides and back, 5 in.
Tubes, number and outside diameter	183—3 1/2 in.	259—2 1/2 in.
Flues, number and outside diameter	36—5 1/2 in.	50—5 1/2 in.
Tubes and flues, length	21 ft.	21 ft. 8 1/2 in.
Heating surface, tubes and flues	3,339 sq. ft.	4,853 sq. ft.
Heating surface, firebox	329 sq. ft.	381 sq. ft.
Heating surface, total	3,668 sq. ft.	5,234 sq. ft.
Superheater heating surface	942 sq. ft.	1,341 sq. ft.
Equivalent heating surface*	5,081 sq. ft.	7,446 sq. ft.
Grate area	66.7 sq. ft.	88 sq. ft.

Tender

Tank	Water bottom 33 in.	Water bottom 33 in.
Wheels, diameter	6 in. by 11 in.	6 in. by 11 in.
Journals, diameter and length	9,000 gal.	9,000 gal.
Water capacity	12 tons	12 tons
Coal capacity		

* Equivalent heating surface = total evaporative heating surface + 1.5 times the superheating surface.

† Includes combustion chamber and arch tube heating surface.

GRAPHIC DISPLAY OF INDIVIDUAL DAILY FUEL RECORDS*

BY HIRAM J. SLIFER

The cost of fuel is one of the largest of the individual items that go to make up the total expense of railway operation. This fuel is used by 99,070 locomotive engineers, divided into classes as follows:

Engineers and motormen, yard	12,797
Engineers and motormen, road—freight	34,226
Engineers and motormen, road—passenger	12,073
Firemen and helpers, yard	13,013
Firemen and helpers, road—freight	35,210
Firemen and helpers, road—passenger	11,749

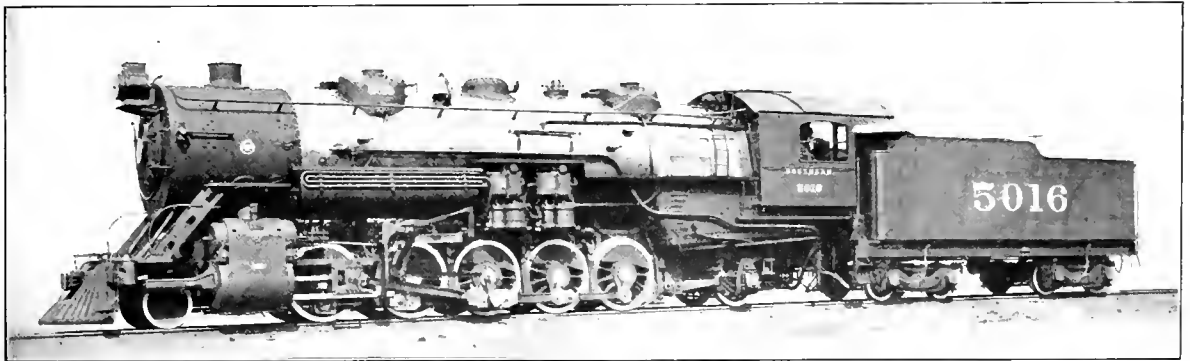

Southern Railway 2-10-2 Type Freight Locomotive

face*	62.0	49.8
Volume both cylinders	18.6 cu. ft.	22.8 cu. ft.
Equivalent heating surface* ÷ vol. cylinders	273.8	326.5
Grate area ÷ vol. cylinders	3.6	3.9
<i>Cylinders</i>		
Kind	Simple	Simple
Diameter and stroke	27 in. by 28 in.	28 in. by 32 in.
<i>Pistons</i>		
Kind	Piston	Piston
Diameter	14 in.	14 in.
<i>Wheels</i>		
Driving, diameter over tires	69 in.	57 in.
Driving, thickness of tires	3 1/2 in.	3 1/2 in.
Driving journals, main, diameter and length	11 1/2 in. by 21 in.	12 in. by 22 in.
Driving journals, front, diameter and length		11 in. by 20 in.
Driving journals, others, diameter and length	10 in. by 12 in.	11 in. by 12 in.
Engine truck wheels, diameter	33 in.	33 in.

These men were employed on 64,950 locomotives (301 electric, 8,688 switching), and hauled 32,334,466 passengers and 277,232,653 tons of freight one mile in the fiscal year ending June 30, 1915.

The magnitude of the question of interesting the employes in the importance of reducing the pounds of coal used may be considered stupendous, and it would be almost impossible to suggest any method for doing so, if its consideration is confined to the foregoing statistics. It is the purpose of this paper, however, to suggest an analysis of these statistics for the purpose of simplifying them, in order that they can be applied to the unit-man and the unit-machine in their respective classes of service, expressed in pictures that will

* Abstract of a paper presented at the 1917 Convention of the International Railway Fuel Association.

be under-tood and interesting, creating a competition that will reduce the unit consumption of coal.

In the first place, two grand divisions of the subject suggest themselves: fuel used by yard locomotives, and fuel used by road locomotives. The latter may again be subdivided under many headings, some of which are suggested:

PASSENGER Mail trains Limited trains Express trains Through trains Local trains	FREIGHT Stock trains Meat trains Fruit trains Coded trains Dead freight trains Local trains
--	---

It is necessary that each of these classes be considered independently of the others, and for the purpose of illustrating how the graphical method may be applied to show the daily performances of individual men and machines the consideration of the subject is confined to the dead or drag freight trains, for the reason that they are in a class that predominates and consumes the larger percentage of the fuel. For the fiscal year of 1915 there were 9.8 enginemen and motormen and 10.2 firemen and helpers employed in freight train road service per 100 miles of line, and it should be safe and fair to estimate that an average freight division will not have more than five dead or drag freight trains passing over it in each direction every 24 hours. With this basis it should be a very simple problem to devise some graphical method by which may be shown a comparison of the amount of coal consumed by each of these 10 machines and the men employed thereon, to haul 1,000 tons one mile. The method must naturally be so flexible that it may be curtailed or extended to cover as few or as many men and machines as may be employed, and it must be applicable to all classes of yard and road service. It should be of such a character as to suggest its use and value for interesting other classes of employees.

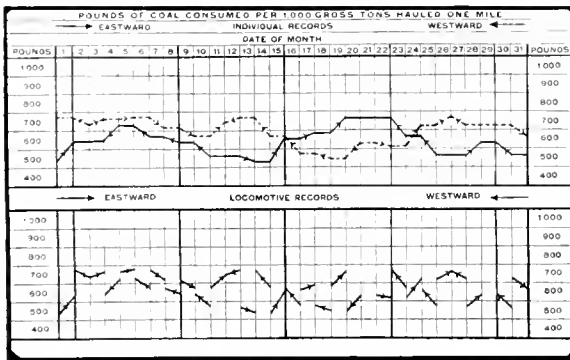

Fig. 1—Graphic Picture Showing Coal Consumed per 1,000 Gross Ton Miles

Some railroads have been for years, and are now, preparing daily statistics for the use of their general and division operating officers, and these are being secured by wire advice sent regularly to the chief dispatcher. Such roads are already provided with the necessary data for determining the pounds of coal used, the tons hauled and the miles made by each individual and each machine. Other railroads should have no difficulty in establishing a similar system. Every dispatcher's sheet now shows or should indicate the tonnage and mileage of every train on his district, and messages will give him a complete daily fuel record, when a few simple calculations will show the pounds of coal consumed in hauling each unit of 1,000 tons for a distance of one mile. If these figures in turn were wired to the master mechanic or the engine house foremen at the terminals, they would be available for illustration, as they are now on many miles of railroad. Up to this point there would be very little additional expense attached to the suggested plan.

The next step will be to establish the necessary boards on which these figures may be shown, through the medium of graphics. These will involve some slight expense, and this will be the only additional cost that will have to be met, as it is expected that some employee will be assigned to the few moments' duty necessary to mark up the day's record.

These boards should be on the walls of the rooms in which the enginemen register for duty. They should be conveni-

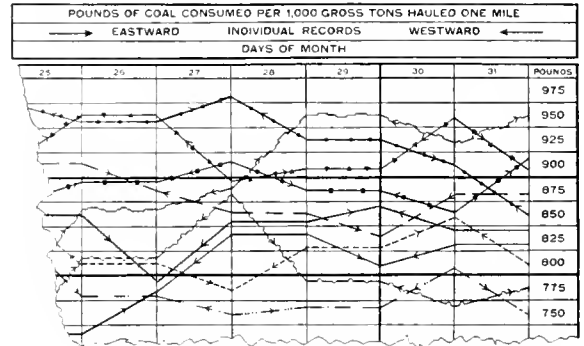

Fig. 2—A Detail View of the Corner of the Graphic-Picture Coal Consumption Board

ently located and well lighted. They may be of simple construction, with black background and white lines. The question of the number of boards to be maintained will depend on many things aside from the various classes of service to be covered. It will also be governed by the space which may be assigned to the boards. Every effort should be directed against any possibility of confusion, which will reduce the interest desired and expected. If the division is double track and of even grades in both directions, all of the records might be displayed on the same board by showing the direction of each train with an arrow, but where it is single track or grades predominate in one direction of traffic, the board should be divided to show the trains in each direction, which will mean the erection of a second board. The records on these boards may be made with white chalk, using different characters to represent each individual and machine, the characters to be known only to the officer and the man interested. If desired, the locomotive may be identified by its number and character.

The wall space available will dictate the shape, size and scale of these boards, which may be varied to suit the conditions. However, the vertical and horizontal proportions should be such as to show the daily unit consumption, distorted as much as possible, so as to emphasize the variations in the amount of coal used. A horizontal scale of 3 in. for each day, with a column for pounds on each side, will require a board 8 ft. wide; a vertical scale of 4 in. for each 100 lb., with the necessary space at the top for proper headings, another at the middle to separate the individual from the locomotive performances, and a third at the bottom for recording engine numbers, with their character or other information will require a board 5 ft. high to cover a variation of 1,000 lb. Such a board is shown in Fig. 1 with the record of one engine as worked by two men.

Some idea of the working appearance of the suggested board is shown in Fig. 2, which covers only one corner of the complete board, but which will show its application. This board shows coal consumed on the basis of gross tonnage, but the same principle may be applied to net tonnage and it may be modified as may seem desirable. It is believed that the employees will soon show by their improved records that the graphic representation of performance displayed each day, has created an interest that will repay the slight expense of its adoption in a very short period of time.



HANDLING HEAVY TRAINS ON GRADES*

While there are probably many shortcomings of the present practices of train handling on mountain grades, a thorough knowledge of the capabilities of the air brakes, together with a good organization for its proper maintenance, will enable very good results to be obtained.

Railways having heavy grades to traverse should establish convenient "dead line" points where their own and foreign line equipment may be properly inspected and repaired before it is permitted to proceed. Such points need not be where the descent of grade begins.

From records obtained at such points, where a thorough inspection is made, it has been ascertained that a large percentage of the brakes are in a very bad condition, showing excessive brake cylinder leakage. This inspection has also disclosed the fact that the retaining valve and its piping are receiving practically no attention by many railroads operating in level districts.

In order to successfully handle heavy tonnage trains on grades with air brakes exclusively, it is imperative that the retaining valves and pipe be in such condition that they can properly perform their work. It is also essential that brake cylinder leakage be reduced to the lowest possible point. A uniform adjustment of piston travel is required.

At the summit of grades a test should be made to ascertain if all brakes are operative, and piston travel adjusted to meet operating conditions.

All mountain railroad men should realize the importance of having the brake system charged to standard pressure before starting from the summit of any grade. Train and enginemen should have a knowledge of the tonnage allowed to be handled over the district, which should be prescribed by special instructions in the time tables.

During cold weather, when operating on grades of 4 per cent and when length of train will permit, it is advisable, immediately after starting and before the entire train is on the descending grade, to apply the brakes and work steam for a short distance for the purpose of wearing off any accumulation of snow and ice that may be between the wheels and brake shoes. Retaining valve handles must be turned to holding position before beginning the descent.

After starting from the summit the engineman should make the first application of the brakes as soon as practicable without stalling, and fully recharge while the speed is low. This is to test the holding power and get the aid of the retaining valves.

The speed of trains for the first mile should be exceptionally low for the purpose of allowing the wheels to assume a gradual heat, to compensate for expansion. The speed thereafter should not exceed schedule running time.

Speeds when on 4 per cent grade should not exceed 10 m.p.h. if braking conditions are favorable. If unfavorable, this speed should not be permitted. Speed and air pressure are the most important factors to be considered.

The engineman must understand that the critical time in

grade braking is during the recharge of brake pipe and auxiliary reservoirs; also, that he should regulate the application of the brakes to maintain as near as practicable a uniform speed. To accomplish this the one reduction method must be followed, making a brake pipe reduction of sufficient amount to hold the train, and in recharging keep the brake valve in release position until brake pipe pressure is entirely restored before returning it to running position. Variation from the above practice is often resorted to by braking from release position and has given very satisfactory results.

When New York *B* brake valve is used it should be kept in release position at all times when brakes are released. In any case the release and recharge should be made as rapidly as permissible. Frequent applications and short holds are preferable to keeping the brakes applied for a long period. By using the short cycle method a more uniform speed can be maintained. This practice is being followed on many railroads where heavy grades are encountered.

Since the use of the hand brake for the control of trains is prohibited, except in cases of emergency, the retaining valve necessarily has to take its place in grade braking; safety depends largely upon its condition and handling.

When handling long freight trains, it is necessary to have the slack bunched in advance of the train brake application.

There are several ways of doing this, but the important feature to be considered is to bunch the slack gently. This can be done successfully by the use of the independent engine and tender brake, but on account of the liability of bunching the slack too severely, the use of the independent or straight air driving brake for bunching the slack is generally condemned. However, it has been proven by experience that by the use of the independent or straight air brake on the locomotive tender alone, the slack can be gently and successfully bunched at moderate speeds without the danger of overdoing the matter and damaging equipment.

After it has been determined that all the slack is in, a moderate brake pipe reduction can be made with no shock of consequence in rear of train. If it is desired to make a stop, the driving brake must be cut in and permitted to work in conjunction with the train brakes.

It many times happens that the main portion of the train is passing over reverse curves with the locomotive and head cars on tangent track and descending grade. Under such a condition there is a tendency for the head portion to run away from the rear portion and the use of the independent brake on tender alone is found to be very beneficial in preventing the running and surging of train slack. In such cases the independent brake should be graduated on and when conditions have changed it should be graduated off.

By taking advantage of the many different conditions met with the independent brake used only on the locomotive tender will be found very valuable in controlling slack and eliminating the danger of slipping locomotive tires.

When a stop is made on ascending or descending grade and the locomotive brake is insufficient to hold the train, or where the engine is to be detached, sufficient hand brakes must be applied on head end to hold it on descending grade

* Abstract of a committee report presented at the 1917 convention of the Air Brake Association.

and on rear end on ascending grade. Under no circumstances should the automatic brakes be depended upon to hold the train while standing.

Liability of wheels sliding is greatest when starting after a short stop, when retaining valves are in use, and sufficient time should be allowed for the retainers to reduce the pressure before attempting to start. Train men should inspect from the ground for wheels sliding; hence, the necessity for the engineman to keep the speed low.

Short movements with long heavy trains should be avoided, but if necessary, a sufficient number of hand brakes must be applied throughout the train to control the slack.

The report was signed by: C. H. Rawlings, chairman; J. E. Fitzgerald, L. S. Ayer and Charles T. Goodwin.

DISCUSSION

On some roads retainers are tested when cars are on the repair track. The weight type of pressure retainer unseats at times due to jarring and pressure is lost. Many cars now in service have very low braking power and maintenance and also manipulation must be of the best. Some special cars used on heavy grades have been braked at 114 per cent on 60-lb. cylinder pressure with good results. The empty and load brake has facilitated the handling of large ore cars on heavy grades.

STEEL PASSENGER TRAIN EQUIPMENT

The Special Committee on Relations of Railway Operation to Legislation has issued bulletin No. 93, which shows that on January 1, 1909, there were in service only 629 all-steel passenger cars and 673 passenger cars with steel underframes, while on January 1, 1917, the number of all-steel cars was 15,757, and the number of cars with steel underframes increased during the same time to 6,386.

The statistics show that the construction of wooden passenger cars has practically ceased and the wooden cars still in service are being rapidly retired. The number of wooden cars in service January 1, 1912, was 48,126, but on January 1, 1917, the number was only 39,169. During the calendar year 1916 alone 2,213 wooden passenger cars were removed from service. The replacement of wooden equipment with steel can not be regarded as a profitable undertaking, but only as a measure of safety. The first cost of steel cars is higher and the available data, though meager, indicates that

Acquired in—	Total number	Percentages		
		Steel	Steel underframe	Wood
1909.....	1,880	26.0 per cent	22.6 per cent	51.4 per cent
1910.....	3,638	55.4 per cent	14.8 per cent	29.8 per cent
1911.....	3,756	59.0 per cent	20.3 per cent	20.7 per cent
1912.....	2,660	68.7 per cent	20.9 per cent	10.4 per cent
1913.....	3,350	63.0 per cent	20.4 per cent	6.6 per cent
1914.....	4,495	74.6 per cent	22.9 per cent	4.5 per cent
1915.....	1,696	73.7 per cent	20.1 per cent	6.2 per cent
1916.....	1,445	92.5 per cent	7.3 per cent	0.2 per cent
January 1, 1917 (under construction).....	1,759	82.5 per cent	16.9 per cent	0.6 per cent

* This figure includes wooden cars reconstructed with steel underframes.

the cost of maintenance is considerably greater than for wooden cars. In its last annual report the Interstate Commerce Commission recommended "that the use of steel cars in passenger train service be required and that the use in passenger trains of wooden cars between or in front of steel cars be prohibited." In view of the fact that of the 1,445 passenger train cars built during the year 1916 only three, or 0.2 of 1 per cent of the total number, were of wood, any legislation of that sort seems quite unnecessary. It is interesting to note that only 7.3 per cent of the cars built in 1916 were of steel underframe construction, as compared with 92.5 per cent all-steel.

The number of cars of steel, steel underframe and wood acquired by the roads during the years 1909 to 1916 inclusive, is shown in the table above.

According to an act of Congress which was signed August 24, 1912, the railroads will not be allowed to use any full postal cars which are not of steel or steel underframe construction after July 1, 1917. The introduction of steel postal cars began before the passage of this act, however, as is shown by the following table:

Postal cars acquired in—	Steel	Steel Underframe	Wood
1909.....	52	70	5
1910.....	140	10	11
1911.....	286	8	11
1912.....	30	16	0
1913.....	101	18	0
1914.....	204	1	0
1915.....	19	3	0
1916.....	29	0	0

It is estimated that the steel passenger train equipment now in use on the railroads of this country has cost the roads \$325,000,000. That the expense of the change from wood to steel has been borne by the railroads is proven by the fact that between 1909 and 1915 (the last year for which figures are available) the revenue per passenger per mile increased only 0.057 cents or from 1.927 cents to 1.985 cents per mile. There are now in service approximately 36,169 wooden passenger train cars. The committee estimates the cost of replacing these cars with steel equipment as follows:

	Average		Amount
	Number	Cost	
Postal.....	237	\$19,600	\$4,503,600
Mail and baggage.....	2,251	17,500	39,392,500
Mail, baggage and passenger.....	547	17,500	9,572,500
Baggage and passenger.....	3,129	17,500	54,757,500
Baggage or express.....	6,608	14,800	97,798,840
Passenger.....	20,906	23,000	480,838,000
Parlor, sleeping, dining.....	4,432	37,000	163,984,000
Business.....	736	26,000	19,136,000
Motor.....	323	35,000	11,305,000
Total.....	39,169		\$881,287,340

The railroads will undoubtedly retire the wooden cars as rapidly as their earnings will permit. Assuming a value of \$4,000 for each car repaired under the classification of accounts of the Interstate Commerce Commission, replacing this equipment will necessitate a charge to operating expenses of \$156,676,000. At an annual rate of interest of five per cent, the annual charge on the investment required for this new equipment will be \$44,064,367.

TYPE OF PASSENGER TRAIN EQUIPMENT IN SERVICE

Sections	Number of roads	In service December 31, 1916		Under construction or contracted for but not yet received on December 31, 1916		
		Steel underframe		Steel underframe		
		Steel	Wood	Steel	Wood	
New England.....	643	344	4,056	49	3	
East.....	67	6,223	1,881	13,846	886	64
Southeast.....	83	548	603	4,212	235	2
Northwest.....	29	734	212	3,640	16	...
Southwest.....	49	678	452	2,876	40	...
West.....	52	3,652	1,491	8,922	103	42
Sleeping Car Co.'s.....	1	3,276	1,403	2,617	122	187
Total United States.....	294	15,754	6,386	39,169	1,451	298
		61,309		1,759		
Canada.....	8	168	385	4,750	51	...
		5,273		51		
Total U. S. and Canada.....	302	15,862	6,771	43,949	1,502	298
		66,582		1,810		

Classes of Equipment:

Postal.....	909	194	237	51	1	...
Mail and Baggage.....	851	454	2,251	117	4	2
Mail, Baggage and Passenger.....	46	57	547	5	2	1
Baggage and Passenger.....	691	204	3,129	103
Baggage or Express.....	2,029	1,485	6,608	324	60	1
Passenger.....	6,047	1,906	20,906	658	42	6
Parlor, Sleeping and Dining.....	4,095	1,829	4,432	182	188	...
Business.....	42	152	736	10	1	...
Motor.....	1,044	105	323	1
Total United States.....				61,309		1,759

Message:

United States.....	235,406
Canada.....	31,299
Total.....	266,705

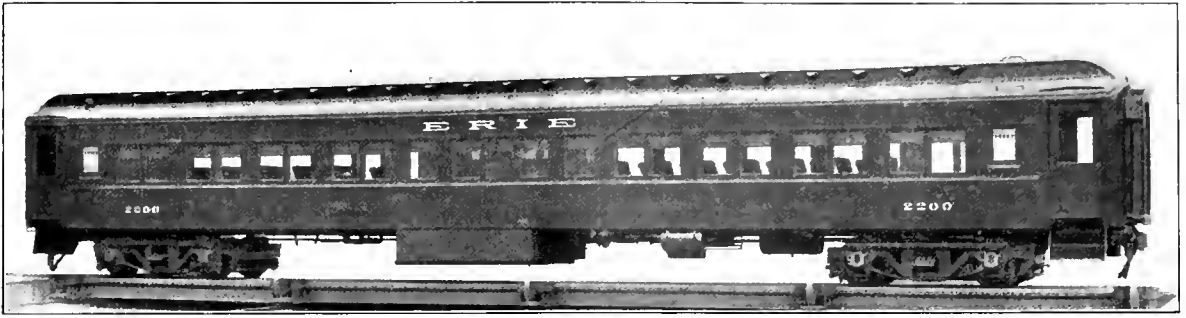

ERIE STEEL PASSENGER EQUIPMENT

For Main Line Service; Important Features Are
Light Weight and Strength of the Superstructure

AN order of five all-steel coaches and one all-steel baggage car has recently been placed in service by the Erie Railroad. These cars, which were built by the Pressed Steel Car Company from designs prepared by L. B. Stillwell, consulting engineer, New York, weigh materially less than the steel underframe equipment now used by the Erie in similar service, and are especially noteworthy because of the distribution of metal in the super-

amount of fuel used per car-mile with the lighter weight.

Aside from the economic advantages accruing from the light weight, the design of the new cars is of interest because of the unusual strength of the car body which is designed especially with reference to its ability to resist destruction in collision or derailment. This is accomplished by the introduction of two new members in the body end, viz., a collision diaphragm forming a ceiling above the saloon, lavatory and passageway between, and special door posts in the body end frame.

The collision diaphragm consists of a horizontal plate

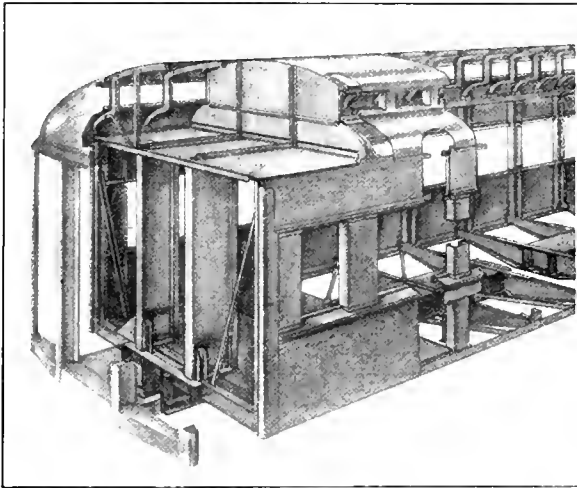

A Perspective View of the Anti-Collision Bulkhead Construction



Interior View Showing the Details of the Body and Underframe Construction

structure, which provides an unusually stiff construction throughout. The light weight of the cars was made possible by following the same system of high truss side frame design, differing only in detail, that was used in the all-steel suburban cars built for the Erie about two years ago, and described in the *Railway Age Gazette, Mechanical Edition*, for July, 1915, page 356.

This saving of weight is of importance not only in effecting a reduction in the first cost through the elimination of unnecessary steel, but also because of the possibility of changing from wood cars to all-steel cars in main line service, without taxing the capacity of existing passenger motive power. In many cases the advent of all-steel equipment has necessitated an increase in the size of locomotives used in through passenger service. A third, and no less important economy, will result from the reduction in the

girder having a 3-16 in. web member placed across the car from side plate to side plate, and extending lengthwise of the car from the door header into the body of the car about 5 ft. 6 in. This horizontal girder securely ties the side walls together at the ends of the car body, and it is expected that in collision the walls will thereby be drawn in to resist penetration, rather than be split apart to allow penetration. Also, this horizontal girder, being backed up by the high girder side frame and tied down by the door posts, is itself expected to offer great resistance to penetration.

The special body-end door posts are in the form of ver-

tical beams 21 in. deep, with 3-16 in. web and pressed steel flanges. They are framed into the underframe below and into the collision diaphragm above, with connections capable of developing the full strength of the beams.

The arrangement of the body door posts and the anti-telescoping tie member is clearly shown in the perspective drawing of the end construction of the car. The vestibules are of the usual construction and obviously are less capable of resisting a severe shock than is the heavy body end construction. Consequently, if the car is subjected to a violent collision shock, the vestibule structure may be expected to

or collision, but in themselves not infrequently increase the destruction of life and property because of the effect of their excessive weight. In case of collision the underframe of at least one car in a train is usually raised at one end above that of the adjoining car. When this occurs, the greater the weight and strength of the underframe as compared with that of the superstructure of the neighboring car, the more effective it becomes in destroying that superstructure.

The additional weight of material incorporated in the heavy body end structure is more than offset by the reduction in weight effected elsewhere in the design. The com-

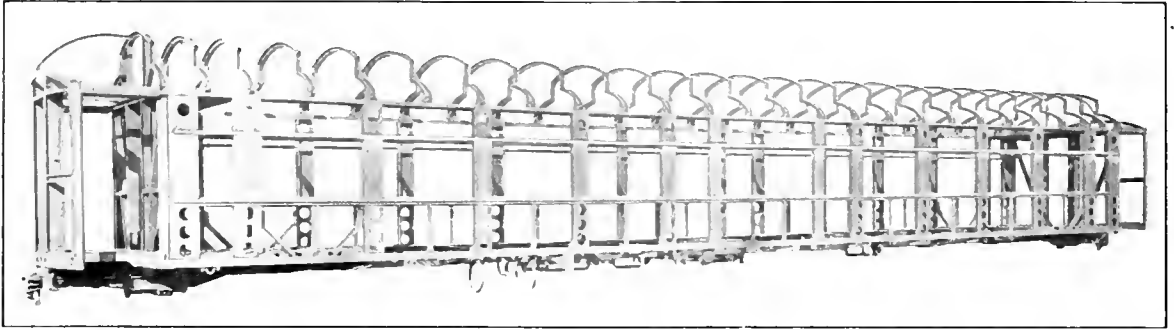

Side Elevation of the Steel Frame of the Erie Coaches

close up against the body of the car and in doing so somewhat cushion the force of the blow. The further progress of the colliding body will be greatly checked, if not arrested by the heavy body end construction. This should greatly reduce, if not eliminate that most common and most destructive form of collision—the splitting open and telescoping of one car by one of its neighbors or by a locomotive.

This design is the result of a careful study of the effects

plete weight of the coaches, including the four-wheel trucks, but excluding the lighting equipment, is 111,000 lb. each. The weight of the car body is such that it may be carried on four-wheel trucks with journal loads well within the limits prescribed by good operating practice.

The framing system of the through line cars is similar to that employed in the Erie suburban cars with the exception that the windows are rectangular, whereas those of the

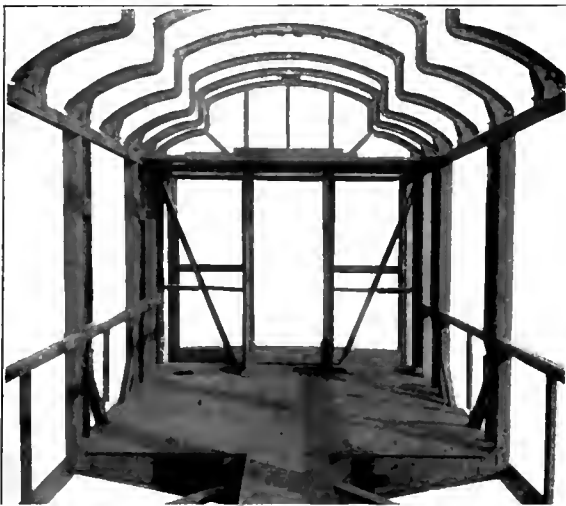

A View of the Framing at the End of the Car, Also Showing the Body Bolster and Underframe Stiffening Plate

of collisions and derailments upon cars, particularly those of all-steel construction, which has covered a period of six years. This study has been based upon personal inspection and examination of the photographic records of many accidents involving passenger equipment. As a result it is the conclusion of the designers that the heavy underframes so generally used in steel passenger train equipment not only afford little protection against damage to cars in derailment

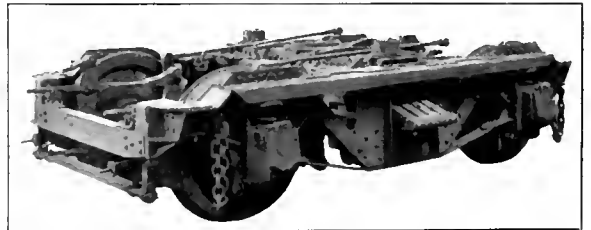

Four-Wheel Truck for Erie Through Line Coaches

suburban cars were of the Gothic form. In each case the vertical members are framed together into a girder, the depth of which is equal to the full height of the side walls, and which acts as a load carrying member. This not only produces a car structure free from appreciable deflection, but greatly increases the safety of the passenger space in case of accident.

The side frame of the car is in the form of a girder 7 ft. 7 in. high, with suitable openings for windows, and has for its bottom member the 4 in. by 3½ in. by 3-16 in. angle side sill, and for its top member the 3-16 in. pressed channel side plate, 5¼ in. wide. The side sheathing and letterboard are ½ in. plate, roller leveled. The main piers extend from sill to plate and are pressed steel channels with reentrant flanges. Main piers, except those at the smoking compartment in the middle of the car, are 12 in. wide by 47⁄8 in. deep, and are formed from various thicknesses of steel plate, as required by their respective locations in the car frame to develop the full depth of the side as a single girder. The piers are braced by the side sheathing and the belt rail below the windows, and by the letterboard and

upper belt rail above the windows. The lower belt rail is a channel-shaped pressing 3-16 in. thick and perforated to receive the main piers.

The center sills are composed of 12-in., 25-lb. channels, with a 3/8-in. top cover plate and 4 in. by 3 1/2 in. by 3/8 in. bottom flange angles, and have a total cross-sectional area of 27.915 sq. in. They are supported and alined by the high girder side frame through the body end sills, bolsters and cross bearers which are placed at every main pier, 5 ft. 11 in. between centers, thus eliminating all possibility of deflection in a vertical plane. For bracing the center sill against horizontal deflection, 12 diagonal braces are incorporated in the underframe, which, with the side sills and cross bearers, form a horizontal truss brace 9 ft. 9 1/2 in. wide. The diagonal braces are 4-in., 5.25-lb. channels. The cars are fitted with friction draft gear of the Miner A-3-P type and class B-10 friction buffers.

The double body bolsters are formed of 5-16-in. pressed diaphragms, 10-in. by 1 1/2-in. bottom cover plates, and a single top cover plate 1 1/4-in. thick, as shown in one of the photographs, forward of this cover plate is a 3-16-in. floor plate extending to the body end sill. This plate securely ties the side sills, end sills and center sills. The cross bearers are all formed of 3-16-in. pressed diaphragms,

shades are used. The power for lighting is furnished by a straight storage battery installation, consisting of a 16-cell, 1,200-ampere hour Wilson battery with lead lined cells. The capacity of this equipment is sufficient to furnish light for the round trip between Jersey City and Chicago without recharging.

The general features of the design of the truck are shown in one of the illustrations, and is similar to that used under the Erie all-steel suburban cars previously referred to, this design having proved very successful in service. The frame is of the riveted truss type and the spring arrangement is such as to secure a remarkably easy riding truck. The riding qualities are considered fully equal to those of the usual type of six-wheel truck. The trucks are equipped with the American Brake Company's clasp brake.

The general dimensions of the cars are given in the following table:

Length over vestibule end sills.....	78 ft.
Length over body end sills.....	70 ft.
Distance between truck centers.....	53 ft. 3 in.
Wheel base of trucks.....	8 ft.
Height of car over-all.....	14 ft. 3 in.
Height of car over sheathing.....	9 ft. 9 3/4 in.
Weight of car body.....	80,660 lb.
Weight of two trucks, complete.....	50,240 lb.
Weight of car without storage batteries.....	110,900 lb.
Storage batteries, boxes and hangers.....	8,760 lb.



Interior of the Erie Steel Coaches

with 3 1/2-in. by 1 1/4-in. top cover plates and 5 1/2-in. by 5-16-in. bottom cover plates.

The roof framing is shown in the two views of the interior of the car frame, and has been made to co-ordinate with the upper portion of the side walls in such a manner as to act effectively in combination with the collision diaphragm, to resist compression stresses and to protect the passenger space in case of overturning of the car through derailment. The roof sheets are 1-16-in. ingot iron, and the carlines are pressed channel, 1 1/8 in. thick. The clerestory is fitted with Ward ventilators.

The seating arrangement of the new cars conforms to that of other cars now in Erie through line service, a smoking compartment seating 12 passengers being placed in the middle of the car. The walls of this compartment are fitted with leaded glass windows and the seats are upholstered in leather. The seats in the rest of the car are upholstered in plush. Each end of the car is fitted with a saloon and lavatory. The seating capacity of the cars is 76, including the 12 seats in the smoking compartment.

The illumination of each car is obtained from ten incandescent lamps set on the center line of the ceiling. Safety Car Heating & Lighting Company fixtures with Holophane

SLACK ACTION IN LONG PASSENGER TRAINS*

Rough handling varying in degree of intensity is reported as occurring during ordinary service applications in handling long passenger trains. This condition is practically universal, although the frequency and severity in such cases vary under varying train conditions, brake conditions and methods of manipulation. The most severe shocks were encountered under low speeds and heavy brake applications.

In order to afford a basis from which the committee might analyze the varying conditions under which good and poor handling prevails, data was collected involving the principal elements to be considered.

Observations.—Some three thousand observations were reported on trains of from four to eighteen cars; however, for trains up to six and seven cars, little rough handling occurred during brake applications, and these not being due solely to slack action, but rather to sudden heavy increases of brake cylinder pressure at low speeds, which produced a high rate of retardation and sudden stops. Shocks involving slack action were confined to starting trains.

Number of Cars and Weight.—Reports received indicate that passenger trains of 14 to 15 cars are quite common in some localities, and that trains up to 18 and 20 cars have been handled successfully.

Table of make-up and weight of engines and cars:

General Make-up.....	Total Light Weight.
(a) Locomotive.....	195,000 to 508,000 pounds
(b) Passenger Cars.....	37,900 to 135,000 pounds
(c) Mail Cars.....	75,000 to 135,000 pounds
(d) Smoking Cars.....	120,000 to 139,000 pounds
(e) Chair Cars.....	95,000 to 140,000 pounds
(f) Dining Cars.....	110,000 to 170,000 pounds
(g) Club Cars.....	136,000 to 142,000 pounds
(h) Sleeping Cars.....	112,000 to 170,000 pounds

Braking Power in Proportion to Light Weight of Cars.—

Engine.	Tender.	Cars.
60 per cent on 50 lb.	80 per cent on 50 lb.	80 per cent on 50 lb.
75 per cent on 50 lb.	100 per cent on 50 lb.	95 per cent on 55 lb.
		87 1/2 per cent on 60 lb.
		90 per cent on 60 lb.
		91 per cent on 60 lb.
		95 per cent on 60 lb.
		100 per cent on 60 lb.
		113 per cent on 60 lb.
		85 per cent on 86 lb.
		90 per cent on 86 lb.

The general practice is to use 90 per cent braking power based on 60 lb. cylinder pressure, although several roads re-

*Abstract of a committee report presented at the 1917 convention of the Air Brake Association.

port the basis of 80 per cent on 50 lb. cylinder pressure, and 85 per cent on 86 lb. Pullman cars equipped with double LN brake at 80 per cent on 50 lb. pressure.

Approximate Average Load in Load Carrying Cars.—Baggage and mail cars are reported as carrying from 5,000 to 40,000 lb., a load of 20,000 to 30,000 lb. being quite common.

Brake Equipment.—PC, UC, PM, LN, J-6, S-1.

Slack Adjusters.—It is the general practice to equip all cars with slack adjusters, regardless of the type of brake.

Piston Travel.—Piston travel standing varies materially in different localities, as follows: Minimum, 5 in., $5\frac{1}{2}$ in., 6 in., $6\frac{1}{2}$ in., 7 in., $7\frac{1}{4}$ in., $7\frac{1}{2}$ in. Maximum, 7 in., $7\frac{1}{2}$ in., 8 in., 9 in.

Reports covering experiments with long piston travel, that is, 7 in. to $7\frac{1}{2}$ in., indicate that such is preferable to a shorter travel, and also indicate that there is a tendency to maintain the piston travel considerably longer than the $5\frac{1}{2}$ in. minimum so generally recommended. It is also stated that by changing 6 in. standing travel to 9 or 10 in. standing, all slack action was practically eliminated under the same method of braking, and that from the results obtained a $7\frac{1}{2}$ in. standing piston travel was adopted.

Direct or Graduated Release.—There seems to be considerable difference of opinion with reference to the use of graduated release with such brake equipment as contains this feature. Of 24 reports, 11 show the use of graduated release and 13 the use of direct release.

Single or Double Brakes.—The major portion of the equipment reported is equipped with single brakes; that is, with one service brake cylinder. However, where Pullman cars are operated, reports quite generally show such cars equipped with double service brake equipment.

Instructions for Brake Operation.—Almost without exception it is the practice to begin the brake application with light reductions, from 6 to 8 lb., although in some instances the range is from 6 to 10 lb. Generally any succeeding reduction following the initial reduction is left to the judgment of the engineer. In releasing the common practice is to use release position of the brake valve, either with direct or graduated release, although running position is used as standard on one railroad, with the graduated release.

The practice of applying the brake before closing the throttle is becoming quite general and is reported as preventing slack action. It is the general practice to stop with brakes applied on the second application, where the two application method is used, if the train consists of more than 9 cars.

Type of Draft Gear.—Friction gear is used quite extensively, and appears to be coming into general use. In some instances entire trains are equipped with friction gear, although the type of draft gear in general service necessitates operating trains of mixed spring and friction draft gear.

Average Slack Between Cars.—From $1\frac{1}{2}$ to 8 in. slack between cars has been noted in handling trains, the maximum occurring between the engine and first car. The average is about 2 in. per draft gear.

Strength of Draft Gear as Reflected by Failures.—It is evident from the investigation that draft gear generally is inadequate for pre-ent heavy passenger service, draft gear failures occurring universally in starting and stopping trains.

Type of Foundation Brake Gear.—While the single shoe type of brake gear is in use generally, the clasp type of brake gear is being gradually introduced throughout the country.

Pressures Carried.—Ninety and 110 lb. brake pipe pressure is the general standard, although in a few instances 70 and 100 lb. is the standard. The main reservoir pressure is generally controlled by a duplex compressor governor, set for 20 lb. excess in running position and 40 lb. excess pressure in lap position of the automatic brake valve.

Main Reservoir Capacity.—General practice is to use 50,000 to 60,000 cu. in. main reservoir capacity.

Slack Action.—Rough handling due to slack action both in starting and stopping trains is reported universally.

Proportion of Auxiliary Reservoirs to Brake Cylinders.—General practice is to use standard auxiliary reservoirs as specified by air brake companies for the various size brake cylinders, although it is found that auxiliary reservoirs much larger than the above are used.

It will be noted that the statements presented at the last convention with regard to rough handling of passenger trains throughout the country is confirmed; also that, in a measure, the causes as enumerated by them exist generally. However, the investigation has developed the fact that improvement is possible through instruction and reasonably close supervision with reference to brake manipulation and maintenance.

The investigation has also developed the fact that rough handling occurs due to methods of brake manipulation where modern brake gear and operating mechanism is in use.

In order to determine the point brought out at the last convention, with reference to maintaining the proper proportion of brake cylinder and auxiliary reservoir volumes as specified by the air brake companies, one railroad company provided an 18-car passenger train for test purposes. The brake equipment on the cars was modified so that the auxiliary reservoir volumes were of such proportions that brake cylinder pressure would be built up in proportion to the brake pipe reduction so that the action of the brakes would very closely resemble the proportions intended by the brake manufacturers. It is very clear from the above tests that notwithstanding the fact that the brake was designed to provide a slow and prolonged service stop, the tendency has been to so change its proportions that its ability to produce a gradual and smooth stop has been greatly reduced or entirely destroyed. The fact has been established that rough or unsatisfactory handling of passenger trains is universally prevalent; also that an attempt is being made to overcome this condition by prolonging the time in which the train is brought to a stop during service applications, by certain methods of manipulating the brake. It is also established that it is possible under such manipulation to provide satisfactory handling, so far as brake applications are concerned, with the addition of a slightly increased flexibility obtained by a modification in piston travel adjustment.

The report was signed by G. H. Wood, chairman; W. F. Peck, M. E. Hamilton, Mark Purcell, C. U. Joy, L. S. Ayer, T. F. Lyons, L. P. Streeter, M. S. Belk, W. J. Hatch, C. H. Rawlings, J. A. Burke, R. C. Burns and Wm. Spence.

DISCUSSION

The report of this committee was accepted without discussion and the committee was continued for another year. There was, however, a discussion of the paper on this subject by J. A. Burke and W. Hotzfield, which was presented last year (see *Railway Mechanical Engineer* of June, 1916, page 299) but held over for discussion this year. The main points brought out in this discussion are as follows:

Bad shocks are experienced at times with all types of equipment but with proper manipulation satisfactory control of trains can be secured. Among the causes of shocks are variations in the braking power due to lack of uniformity of piston travel, non-standard auxiliary reservoirs, or design of foundation brake gear, and the tilting of trucks equipped with the single shoe type of brake. It has been found best to make a light application before closing the throttle, making any further reduction required to secure the desired braking effect in one application. It is not advisable to use the two-application stop with long trains. The brake equipment should be modified so that it would be easier for the engineman to avoid shocks. Relatively long piston travel is an aid in securing this result. The standard sizes of auxiliary reservoirs should be adhered to. The adoption of the clasp brake will result in a great reduction of shocks.

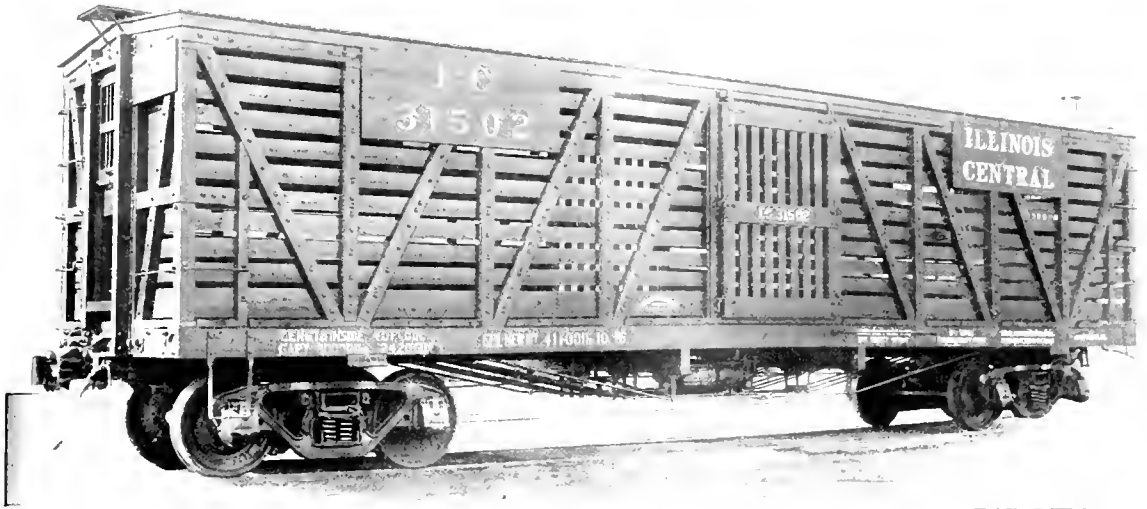

WOODEN STOCK CARS FOR THE I. C.

Cars Built Largely of Wood on Account of the High Price of Steel and Which Have Given Good Service

A SUCCESSFUL design of wooden car which was built to meet the present conditions is illustrated by the 300 stock cars which were delivered to the Illinois Central several months ago by the American Car & Foundry Company.

These cars, which were designed by the railroad company, are constructed largely of wood, but have cast steel bolsters, draft arms and striking plates, steel reinforced ends and steel carlines. They have been so satisfactory that it is planned to build another lot of similar design. The cars are of 80,000 lb. capacity and have an average light weight of 41,000 lb. They are 40 ft. long inside and

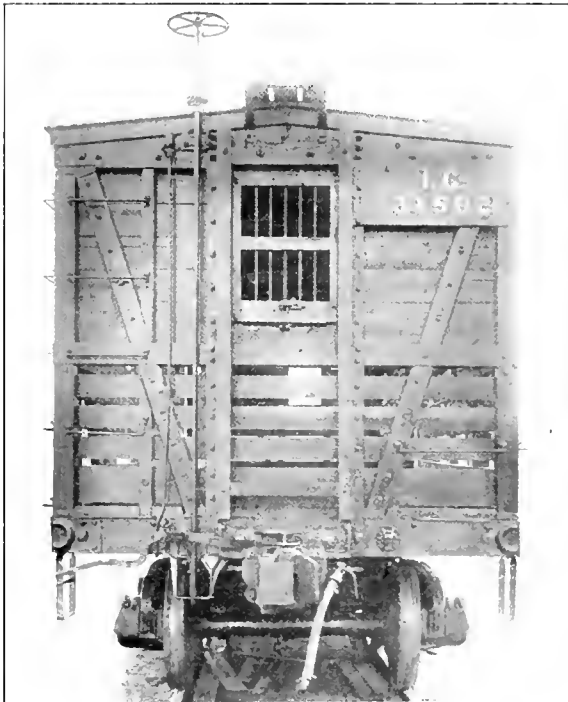

End View of Illinois Central Wooden Stock Car

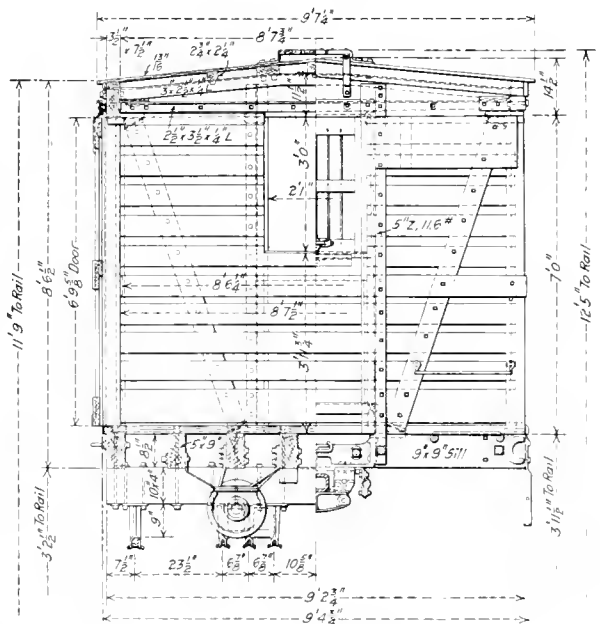

Half End View and Section of Illinois Central Stock Car

dry Company. These cars, which were designed by the railroad company, are constructed largely of wood, but have

40 ft. 10 in. over the end sills. The width between the belt rails is 8 ft. 6 1/4 in. and over the eaves 9 ft. 7 1/4 in.

The main draft members are made up of two 5-in. by 9-in. sills, to which are attached cast-steel draft arms, designed to meet M. C. B. requirements. Above the draft arms and

riveted to them is a cast steel striking casting. Two of the truss rods pass through the casting and the Z-bar end posts are riveted to it on either side. The double pocket coupler is fitted with one M. C. B. Class G draft spring and one 8-in. by 8-in. friction spring. The end framing is a combination of steel and wood types. On each side of the door openings at the end is placed a 5-in., 11.6-lb. Z-bar which is riveted to the striking casting and bolted to the end plate. Inside the Z-bars and bolted to them are two 5-in. by 3 $\frac{1}{4}$ -in. wood posts. The diagonal end braces are 5 in. by 3 $\frac{1}{4}$ in. and the ladder cripples are 3 in. by 3 in. The end belt rail is reinforced by a steel tie 5 in. wide and $\frac{3}{8}$ in. thick fastened to the Z-bar end posts and to the side belt rail. Steel corner plates are fitted at the intersections of the side plates and end plates and side sills and end sills. The end slats and belt rail are 1 $\frac{3}{4}$ in. thick.

The underframe is made up of eight 5-in. by 9-in. sills, with cast steel bolsters and 4-in. by 5-in. sub-sills under the draft sills. The end sills are 9 in. by 9 in. and the needle beams 4 in. by 10 in. Waterproofing is applied over the sills under the floor. There are eight 1 $\frac{1}{8}$ -in. truss rods with 1 $\frac{3}{8}$ -in. upset ends arranged in two groups of three near the center line and two single rods close to the side sills.

The upper framing, except the ends, has wooden posts. The corner posts are 5 in. by 5 in., the door posts 5 $\frac{1}{2}$ in. by

4 9/16 in. and the intermediate posts and king posts are 5 in. by 2 $\frac{1}{2}$ in. The posts fit into malleable iron pockets at both top and bottom and are rabbeted to receive the $\frac{3}{4}$ -in. vertical tie rods. The side plates are 7 $\frac{1}{2}$ in. by 3 $\frac{1}{2}$ in. mortised for the tenons of the end plates and tapered on the upper edge to conform with the roof purlines. The center belt rail is 1 $\frac{3}{4}$ in. by 5 $\frac{1}{2}$ in. and is located 2 ft. 10 $\frac{1}{4}$ in. from the floor. The bottom belt rail, or base board, is 1 $\frac{3}{4}$ in. by 9 in. set to give $\frac{3}{4}$ in. clear opening above the top of the floor. The side slats are 1 $\frac{1}{8}$ in. by 5 $\frac{1}{2}$ in. spaced with 2-in. openings between the slats. The belt rails and slats are bolted to the side posts and all inside edges are rounded. The flooring is 2 $\frac{1}{4}$ in. thick, butt edged. At the side door threshold a 2 $\frac{1}{2}$ -in. by 2 $\frac{1}{2}$ -in. by $\frac{1}{4}$ -in. steel angle is applied.

The roof is of the single board type 1 $\frac{3}{16}$ in. thick. The ridge pole and the four purlines are of wood supported on carlines of 3-in. by 2 $\frac{1}{2}$ -in. by $\frac{1}{4}$ -in. angles which are bolted to the side plates. Cast steel side frame trucks are used under these cars. The air brake is the New York Air Brake Company's schedule C F-C-10.

The Illinois Central is now planning to build several hundred stock cars in the company's shops which will be duplicates of the former order. There will also be built box cars which will be of similar construction but equipped with all-steel ends, steel roofs and metal-bound doors.



THE SAFETY APPLIANCE STANDARDS*

Necessity of Federal Control; Reasons for the Selection of Fixed Dimensions and Locations

BY HIRAM W. BELNAP
Chief of the Division of Safety, Interstate Commerce Commission

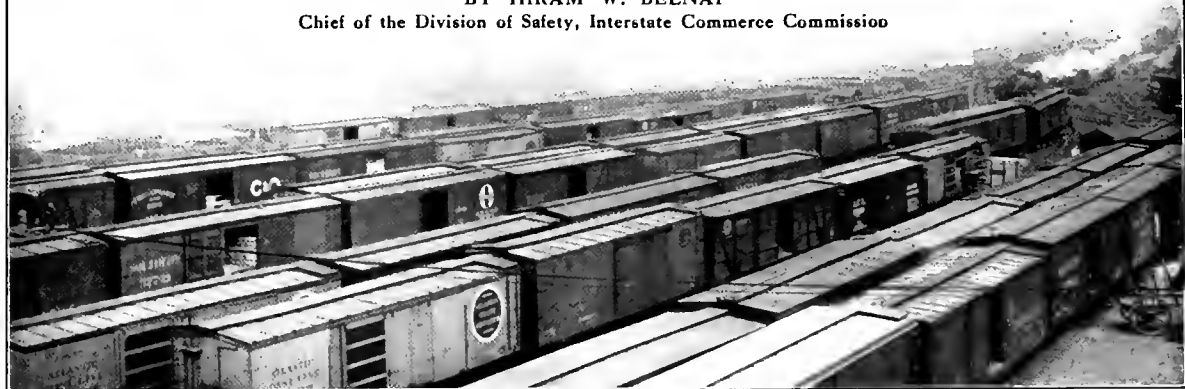

IN the early days of railroad operation the safety appliance equipment of cars on different railroads was arbitrarily fixed by different operating officers, and then, as now, opinions varied widely. In those days the interchange of cars was not thought of; and there was no necessity for any uniform standard.

As the carriers' business grew, however, the necessity of eliminating delay incidental to transfer became obvious, and when the cars of one railroad began to be delivered to other railroads one of the first lessons learned in this school of experience was the fact that better service could be given, repairs could be more promptly attended to, and a greater degree of safety for trainmen and switchmen could be provided by fixing standards for many of the appliances used on

cars. For the purpose of creating a satisfactory medium for a study of such problems, the Master Car Builders' Association, or rather the National Car Masters' Association, as it was first called, was organized. I shall endeavor to show how closely the recommended practices and safety standards of the Master Car Builders' Association have been followed in the safety appliance standards fixed by law and by the Interstate Commerce Commission's order.

The early records of the association are incomplete, but the minutes of the third annual meeting, held at Chicago, June 9, 1869, contain quite a full discussion concerning a resolution offered, fixing a standard height for bumpers. In this discussion it is said:

"Consequently, it is necessary, both for economy and safety to men in coupling, also for rapidity in making up

*From a paper read before the Cincinnati Railway Club, May 8, 1917.

trains, that the height of drawbars be as uniform as possible. Everyone familiar with the making up of trains knows that it is in consequence of the great difference in the height of buffers that so many of our men employed in coupling trains are injured and lives lost, because drawheads do not come in line, one being high and another low, thus driving by and crushing the man that is in performance of his duty, or maiming him, frequently, for life."

It will thus be seen that one of the very earliest matters discussed by the Master Car Builders' Association was standardization, dealing with a condition which at that time resulted in more accidents that occurred from any other one cause. Indeed, the record shows that the question of personal safety of employees received prominence in the discussions before there was any discussion concerning rules of interchange between carriers.

Eight years later the matter of a uniform and standard location for ladders was first discussed, and while the idea received support, there were differences of opinion as to whether the ladders should be placed on the sides or on the ends of the cars. This difference of opinion continued until 33 years later when the Interstate Commerce Commission settled the dispute by requiring both end and side ladders on all cars requiring ladders.

In 1879 the association adopted the recommendation that running boards on cars should not be less than 18 in. in width and project $5\frac{1}{2}$ in. beyond the end of the car, the projecting end to be supported by two metal braces; and that there should be two good, substantial steps of wrought iron of $1\frac{3}{4}$ -in. by $\frac{1}{2}$ -in. metal, fastened on each side sill at diagonal corners of the car; and, further, that each box and stock car should have two ladders of not less than five steps each, of $\frac{5}{8}$ -in. round iron, projecting $3\frac{1}{2}$ in. from the siding of the car, securely fastened to each end of diagonal corners, with a roof handhold directly over the ladder, the lower step of the ladder to be provided with a guard.

In 1885 a committee reported upon the comparative advantages in the construction of freight cars with or without end platforms, and laid the foundation of what is now covered in the Commission's order under the heading, "End Ladder Clearance."

Recognizing that in order to provide proper safety there should be a uniform location for hand brake shafts, a committee in 1875 recommended that the best possible position for brake shafts was the left-hand corner of the car as one stands on the track facing the end of the car. While no definite action was taken on this recommendation at that time, it was adopted in 1879. Regardless of this fact, however, thousands of cars were placed in service that did not comply with this recommendation. Thirty years later, in 1909, a committee submitted to the Master Car Builders' Association a report definitely fixing certain standards in the construction of the hand brake. This report was submitted by letter ballot to the membership to be adopted as recommended practice. The hand brake arrangement described in that report is the standard hand brake required by the Commission in its order issued two years later.

If there be any doubt in the mind of anyone as to the necessity of legislation definitely to fix and locate standard safety appliances, this study of the record of the Master Car Builders' Association appears to be convincing. The recommended practices and the standards fixed by that association, which are well recognized as the safest and best, but which were not mandatory, were deviated from in such a radical manner that it was only through the strong pressure of legislation that they could be made positive and permanent.

When the question of arranging for the number, dimensions, location and manner of application of the appliances required to be fixed by the Commission was taken up, the committee representing the Commission, in conference with

a committee designated by the president of the American Railway Association, was instructed to follow as closely as possible the M. C. B. standards and recommended practices concerning these appliances. In so far as it was possible to do so and provide the proper factor of safety, these instructions were strictly adhered to. In some of these regulations the dimensions or location of an appliance are fixed to the inch, and even to the fraction of an inch; and while this may seem upon superficial view to be arbitrary and unreasonable, the specified measurement in every instance is founded upon a good, substantial reason.

Merely uniformity is not alone the reason for the exact specification of measurements; the question of safety is also involved. But the measurements prescribed are also of incalculable practical advantage in enabling every railroad company to carry in stock appliances which, whenever repairs are necessary on any foreign car while on its line, will be found available.

There were two good reasons why the hand brake was definitely located on the left side of the car. A large majority of cars already had the hand brake on the left side, and the M. C. B. recommended practice called for the hand brake on the left side of the car. Uniformity of location was required so that the hand brake could be located by an employee with certainty even though he were working in great haste. Locating the hand brake definitely on one side of the car also removed the danger of an employee being fouled by the hand brake wheel on the adjoining car, which sometimes occurred where brake shafts were applied indiscriminately.

The order requires the hand brake and air brake to operate in harmony. It is a well known fact that if the hand and air brake do not work in harmony a dangerous condition exists because the air brakes may be applied suddenly while an employee is operating the hand brake. He is then in danger of being thrown from the top of the moving car, or in case a club is being used, of being struck in the side with sufficient force to break a rib. I have seen brakemen with their sides bruised and bleeding from being struck by their brake clubs when using the hand brakes to assist in holding trains on heavy grades.

Brake shaft size is fixed at not less than $1\frac{1}{4}$ in. in diameter. Brake shafts of smaller diameter were too often twisted off when brakemen attempted to stop heavy drafts of cars in hump yards where brake clubs were used in the ordinary performance of their work. The requirement that the brake shaft should be without weld is for the purpose of establishing with certainty as far as possible that the brake shaft is of clean, clear metal. Prior to the adoption of these standards inspection disclosed hand brakes with shafts broken at the weld. This led to the conclusion that it is not feasible in practice to determine merely by inspection whether or not a weld is a good one.

The requirement that the brake wheel shall not be less than 15 in., preferably 16 in., in diameter was adopted because it established a proper ratio in connection with the ratchet wheel, which was to have not less than 14, preferably 16, teeth. For every three inches the hand on the brake wheel moves, the ratchet wheel is moved forward one notch, thus furnishing the greatest degree of efficiency, and at the same time providing the greatest factor of safety for the employee manipulating the hand brake. If there were fewer notches in the ratchet wheel, the hand would travel much farther to reach a notch in the ratchet wheel, and in many instances efficiency of the hand brake would be impaired. The requirement that the brake wheel shall not have less than four inches clearance was for the purpose of providing sufficient room for an employee's hand when using the hand brake, as well as to correct an evil that was developing in equipping high-side steel gondola cars with brake wheels that barely cleared the tops of the ends of the cars, leaving

but little room between for the brakeman's hands and not enough for a brake club.

It may be interesting to know why the brake shaft was located not less than 17 in. nor more than 22 in. from the center of the car. The cars of greatest width at the time the Commission's order was under discussion were practically 10 ft. wide. One-half of this width left 5 ft. on each side from the center of the car. Beginning at the center of the car the first requirement to be met was that the running board must be not less than 18 in., preferably 20 in., in width. This took 10 in. of the five feet. If a 16-in brake wheel is used, one-half the wheel extending from the staff to the edge of the running board would require the staff to be 18 in. from the center of the car, and it was to prevent the location of the brake staff nearer the center that this minimum distance is prescribed, and under no circumstances can the brake wheel foul the running board. On many cars a brake-step board is used. To provide proper safety its minimum length should not be less than 28 in., and by restricting the location of the hand brake shaft to not more than 22 in. from the center of the car, the brake-step board extends beyond the brake shaft a sufficient distance to furnish secure footing to employees, and at the same time does not extend beyond the inside clearance of the end ladder. Inasmuch as the outside end of end ladders may be as far as eight inches from the side of the car, a minimum length of tread of 14 in. is established for end ladders for the reason that all cars were not of sufficient width to insure the use of a ladder with 16-in. treads. Following these standards, cars can be built so that the ladders, brake-step boards, hand brakes and running-boards will each furnish their full factor of safety without interference.

In order that the hand brake wheel might not encroach too far upon the end ladder clearance and thus be a menace to brakemen using end ladders, the order provides that the brake wheel shall not extend to within four inches of the vertical plane limiting this clearance. By such an application, protection is furnished employees when using the hand brake, and they are protected from being struck by any portion of an adjoining car.

All of the arrangements shown in the Commission's order relative to the method of attaching the brake wheel and the ratchet wheel to the brake shaft, the brake chain to the brake shaft drum, and other details of construction were adopted for the reason that, after having been carefully considered by the Master Car Builders' Association, they had been recommended as furnishing the proper factor of safety.

The safety appliance act specifies that all cars requiring secure running boards shall be so equipped. The Commission's order fixes their width at not less than 18 in., preferably 20 in., and requires that they shall run the full length of the car at the center of the roof. The width of running boards is practically the same that was established as early as 1879 as the proper and safe width for running boards by the Master Car Builders', and as the minimum that will furnish a proper and safe pathway for employees while passing over cars that many times are moving at high speed. In icy or frosty weather great danger exists by reason of employees slipping while trying to descend from the tops of cars with metal roofs, and to meet this condition the order requires on such cars latitudinal extensions of not less than 24 in., in width. Refrigerator cars are usually equipped with ice hatches at the corners, and if so equipped, do not require these latitudinal extensions, as the danger of slipping is not present. Running boards on some cars had trap-doors in them that were often left open; and then, too, employees were constantly being injured by falling from and being thrown from the tops of cars by reason of tripping over the nails and other insecure methods of fastening running boards. To remove these dangers the order states that while the running board may be made up of a number of pieces, it can not

be cut or hinged at any point and must be securely fastened with screws or bolts. Considerable difficulty was experienced in making it understood that the so-called drive-screws or fluted nails could not be used in place of screws or bolts for the purpose of securing running boards to saddle blocks. Experience has shown that such drive screws do not properly perform the work demanded and their use is clearly a violation of the standardization order of the Commission.

Recognizing the ever-present danger to employees in passing from car to car, special provision is made to extend the running board beyond the ends of some cars for the reason that unless this is done the distance would be entirely too great for the average man to step from one car to the next one; and at the same time in order to prevent the running board projecting so far beyond the end of the car as to strike adjoining cars, the order provides that the ends of running boards shall not be less than 6 in. nor more than 10 in., from the vertical plane from which end ladder clearance is reckoned. When running boards project more than four inches from the edge of roof of car they must be securely supported so that in case an employee should step on the extreme end no danger will be encountered by the breaking off of the end of the board.

Both observation and experience had shown that unless a proper sill step is furnished, men will step on the arch bars, oil boxes and brake beams, even clinging to the ends and sides of the cars, while doing switching. To furnish proper safety, sill steps of sufficient width of tread and close enough to the ground to be used conveniently, furnish the only means possible to prevent employees using other and more dangerous footholds in their work. A great many cars were already equipped with four sill steps and four ladders at the time the Commission's order was promulgated, and this condition was advanced as one of the reasons why all cars should be so equipped. It was finally determined that four sill steps were required on cars to furnish a proper degree of safety to men in switching. The M. C. B. recommendation as to cross-sectional area for sill steps and dimensions for ladder rungs was adopted for the reason that experience had demonstrated their safety.

The distance at which the sill step should be placed from the top of the rail, what should be the proper spacing of ladder treads and what distance should be maintained between the ends of cars was determined after interviewing and carefully measuring nearly 1,000 railroad men in different terminal yards. This scientific and practical method of determining how high sill steps should be from the top of the rail, what distance was necessary between the ends of the cars in order to provide proper safety to the men using end ladders, as well as to ascertain the proper spacing of ladder treads, was undertaken so as to establish beyond question just what dimensions were proper and should prevail. It was found by these measurements that a man's average perpendicular step was about 19 in. To prevent the application of ladder treads of uneven spacing that might be a menace and mislead employees using ladders, particularly at night, it was decided that the spacing of ladder treads should be uniform, a variation of no more than 2 in. being permitted. A maximum distance of 19 in. was fixed so that the average step a man may desire to make in ascending or descending a ladder could not be exceeded.

The question of end ladder clearance was determined after it had been found that the average measurement of a man from his hip to his knee was 22½ in. Cars were being built with end ladders that constituted a menace to employees required to use them, for the reason that the clearance space furnished at the end of each car in some instances did not exceed 8 in. or 9 in., and in some cases where cars had truss rods extending across the ends, even this slight free space was encroached upon. It can thus be seen that a fundamental safety requirement demands the end ladder clearance required on

every car. Safety for employees using end ladders requires a space between the ends of the cars greater than this average distance, so for this reason it was determined that when cars were coupled together the ends of the cars above the end sills should not be closer than 24 in. It was found that this could be provided in all classes of equipment by fixing the basic point from which to measure on a line in a vertical plane passing through the inside face of the knuckle when closed, with the coupler horn against the buffer block or end sill. This end ladder clearance is only required for 30 in. from the side of the car for the reason that that distance was found sufficient to cover the end ladder location on all classes of equipment.

If end ladders only were provided on cars a material element of danger would be present in using them when switching in yards and also on account of the closing in of cars at the corners when rounding curves. For every degree of curvature the cars at their corners close in .42 in., so that on 10 to 15-deg. curves, many of which exist in yards, the corners of the cars are from four to six inches closer together than when the cars are on straight track. To eliminate this danger side ladders, as well as end ladders are required. On the other hand, if only side ladders were provided on cars, there would be a material element of danger in using them on account of the close clearance of many bridges, tunnels, buildings, freight houses, and the extremely limited clearance between tracks, particularly in the eastern portion of the country, where the tracks were built when cars were much narrower than the present equipment. The end ladder furnishes protection when working in such places.

The proper location for side and end handholds was determined in the same manner as the location of sill steps, spacing of ladder treads, and end ladder clearances. Employees were interviewed and measured for the purpose of determining at what point it was best to place these safeguards, and it was found that by placing the side and end handholds not to exceed 30 in. above the center line of the coupler, the best possible location was provided. In order to prevent handholds being applied too far below this location and to establish practical uniformity, a variation of not to exceed six inches below this point was named as a limit. In addition, in order to provide proper safety for employees required to couple and uncouple air hose, it was found necessary to place handholds on the face of the end sills so that in case cars were suddenly or unexpectedly moved an employee might have a close and convenient handhold to grasp and thus protect himself from serious injury or possible loss of life.

On cars that have platform end sills an additional end handhold is required, placed not more than 60 in. above the platform end sill. This handhold serves as a protection to employees when crossing over cars on the end sills and its necessity is plainly apparent. The earliest recommendation covering handholds made by the Master Car Builders' Association provided that they must be two feet in length, but this dimension had been changed from time to time until handholds 12 in. in clear length were recognized as meeting safety requirements. When the question of definitely fixing the dimensions required by the safety appliance acts came up for discussion by the committee fixing the standards, it was very readily decided that no handhold would furnish the proper factor of safety to employees unless its clear length be at least 16 in. After consideration and further investigation of all classes of cars, a slight modification was permitted in the equipping of cars with certain end handholds 14 in. in length. This can be done only when the construction of the car renders it impossible to use 16 in. handholds.

The many types of couplers led to the use of several different kinds of uncoupling mechanisms. Uncoupling levers that were actually a menace to the employees required to use them were in use on some classes of equipment. A re-

cently made tabulation of all the cases that have been prosecuted under the safety appliance acts disclosed the interesting fact that approximately one-half were for inoperative and defective uncoupling mechanisms. The Commission's order does not require any particular type of uncoupling lever, but clearly states that the uncoupling levers may be either single or double and of any efficient design. They must extend a sufficient distance from the center of the car to insure that an employee using them shall not be between the ends of the cars while doing so, and if of the rocking type, safety requirements are only met when a lock or stop is used that will prevent the inside end from flying up and over in case of breakage, as accidents from this cause have frequently occurred.

In the early records of the Master Car Builders' Association are found many discussions relative to the use of lag screws and even nails in applying handholds, ladder treads and other appliances on cars. For many years it has been recognized as the best practice to use only bolts or rivets. The safety appliance acts required that the manner of application should be definitely fixed, and inasmuch as the greatest safety could only be furnished by the use of bolts or rivets, their use was required.

From the statistical reports of the Interstate Commerce Commission, figures covering two five-year periods have been taken and the results compared. These figures show average results for five years immediately preceding and for five years immediately following the issuance of the Commission's order of March 13, 1911, namely, 1906-1910 and 1911-1915. Five-year averages are taken for the reason that more uniform results are thus obtained than could be secured by comparing the figures for single years:

	Average for 1906-1910	Average for 1911-1915	Increase, per cent
Locomotives in service....	55,990	63,365	13
Cars in service.....	2,165,059	2,439,862	13
Cars per train.....	27.2	31.3	15
Tons per train.....	359.3	432.3	20
Tons hauled one mile.....	228,936,078,705	276,882,678,387	21
Employees in train service	294,915	310,590	5

In the first five-year period there were 1,219 employees killed and 15,910 injured while engaged in coupling and uncoupling cars. In the second period the number killed was reduced to 857, a reduction of 30 per cent, and the number injured fell to 14,245, a reduction of 10 per cent. In accidents to employees due to falling from cars and getting on and off cars the results were not so favorable. While the number killed fell from 3,247 to 2,537, a total of 710, or 22 per cent, the number of employees injured increased from 59,006 to 68,179, giving a total increase of 9,173, or 16 per cent.

These figures are significant only as indicating a tendency, and I do not want to be understood as claiming that all the improvement shown is due to the Commission's order. That is perhaps the determining or controlling factor, and because of its existence other factors of safety have been brought into play. It is clear, however, that the tendency is toward greater safety, and while giving full credit to other factors, we are justified in concluding that the laws, through the Interstate Commerce Commission's methods of administering them, are substantially accomplishing the purpose of their enactment.

For many years the Interstate Commerce Commission has distributed thousands of copies of the safety appliance acts and the Commission's orders issued pursuant thereto, and arrangements have been made so that they may be secured in any number at the cost of publication from the Superintendent of Documents, Government Printing Office, Washington, D. C. These pamphlets should be placed in the hands of all employees charged with any duty in maintaining these safeguards if full compliance with all the requirements of the safety appliance acts is to be expected.



SHOP PRACTICE



DRIVING BOX SPRING SEAT MILLING MACHINE

BY F. W. SEELERT

The photograph shows a simple shop-made milling machine which is used to replace the usual hand chisel and hammer method of finishing the spring seat pockets in the top of locomotive driving boxes.

The frame of the machine, as shown in the photograph, is made up of a number of cast iron parts which were ob-

by means of the clamp nut *D*. The handwheel *E* operates a clamp which closes up against the face of the driving box and holds it securely in position. At *F* are shown two end mills of the type used in the miller. The spindle is operated by means of an air motor, which is held from turning by a vertical arm bolted to the cross slide.

The average time required to finish the two pockets in one driving box by the old method of hand chisel and hammer, was from one to 2½ hours. This milling machine has reduced the time to from 25 minutes to 40 minutes and a much better job is obtained. The machine as shown in the photograph takes boxes up to 12 in. wide. Its total weight is 420 lb.

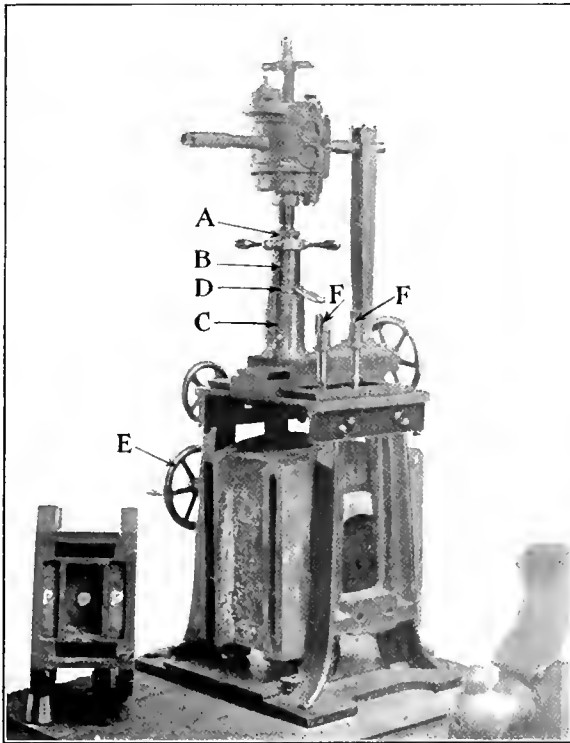

Improvised Miller for Finishing Driving Box Spring Seat Pockets

tained from a scrapped machine tool. Where material of this kind of a suitable nature is not available, a few pieces of heavy boiler plate and structural shapes could be used to equal advantage. On top of the frame is mounted a compound slide, the spindle carrier being rigidly attached to the cross slide.

The spindle of the machine is shown at *A*. It is mounted on ball bearings in the adjusting sleeve *B*, which is threaded on the outside and screws into the spindle carrier *C*. This provides a simple means of vertical adjustment for the cutter spindle, which may be locked in position when the location of the spindle for the desired depth of cut has been obtained,

MILLING MACHINE PRACTICE IN RAILWAY SHOPS

BY C. A. SHAFFER

General Inspector of Tools, Illinois Central, Chicago, Ill.

From a general viewpoint it does not appear that milling machine practice in some railroad shops has been given the attention or consideration that this particular method of machining merits. While there are some progressive shop men who have gone into the details of this class of work and made use of advanced tools and ideas concerning their application and have obtained very good results, there are many places where the field for improvement along this line is large.

The average railroad shop of fair size has in its machine tool equipment, one or more of the horizontal knee type milling machines. They are usually found in the tool room and are used for fluting reamers and taps or machining the shanks of such tools, also cutting shaft keyways and other miscellaneous jobs. In the main shops of large roads will also be found the larger horizontal millers commonly used for surfacing and fluting locomotive rods, machining shoes and wedges, eccentrics, etc., while the heavier vertical type machine is engaged on profiling and other irregular surface work or perhaps milling port openings in valve chamber bushings. There is no question but that modern high duty machines permit of doing more and perhaps better work, but these would be of little use if they were not equipped with the proper cutting tools and in the case of milling machines, regardless of the type, design or age, it is essential that good cutters be used in order to obtain the best results therefrom.

The modern type of milling cutters as now used, in most up-to-date shops, differ considerably from those generally in use but a few years ago, both in design and material. The old style carbon steel cutter with many teeth, narrowly spaced, had to give way to the high speed cutter having few wide spaced teeth. It is hard to realize the advantages these new types of cutters have over the old style until a comparison has been made of the work each will do. The wide spacing permits larger and stronger teeth and better clearance and escape for good large chips, consequently greater feeds can be used. It also lessens the amount of grinding

necessary and the tendency to heat the cutter and work while in operation. It was noticeable, that very soon after the introduction of these coarse tooth type cutters, the leading manufacturers accepted the advanced design and are now showing them in their catalogs. In many of these new design cutters, considerable attention has been given to the spiral and for the various classes of work care should be taken to secure the proper lead, pitch and form of teeth for such cutters.

In the last few years nearly all milling cutters for rapid heavy duty work have been made of high speed steel, the small sizes being cut from solid stock and the large ones usually built with bodies of cheaper material and inserted high speed steel teeth. There is no question but that high speed steel is the proper material for such tools and will continue to be used by exacting mechanics even at the present high price. The necessity for economy in this line however, has caused wonderful development in the design and construction of inserted tooth cutters to fully meet the requirements and which are equal in performance to those made from the solid material.

One of the greatest factors for efficiency in milling is proper lubrication of the cutters. Without some good means of cooling, it is impossible to get near the maximum amount of work out of any design of cutters for the limit of speed is reached when the cutter burns. Therefore, in order to prevent destruction of the tool and to get the most out of the cutters it is necessary that they be kept cool. This is accomplished by the proper application of lubricants and it has been demonstrated that the nature of the lubricant is of minor importance so long as a sufficient quantity is provided. One of the prominent milling machine manufacturers after making exhaustive experiments along this line has developed a very complete system of cutter lubrication, which is featured in connection with its make of machines, special appliances being furnished for the equipment when required. This system provides for a liberal stream of fluid, which is forced upon the cutter through a hood, keeping the cutter cool and also serving to wash away the chips, which adds to the life of the cutter.

The possibilities of milling with helical cutters are very great and many shops are employing this method for cutting blocks from the solid in steel or iron, where formerly the job was done by drilling holes to release the block and then finishing to size on the slotter or shaper. Where proper equipment is used for such work the time is greatly in favor of the milling process and the increasing amount of work being done in this manner bears evidence of the fact. One particularly small job of this character which may be interesting is the milling of keyways in piston rods or cross heads instead of drilling, chipping and filing them. This job may be done on a knee type milling machine but there are some good small portable devices which were recently brought out by the use of which a considerable saving may be effected. A high speed three-tooth helical cutter is used and if driven to capacity will cut keyways in piston rods in from 12 to 30 minutes each, depending upon the size and nature of the material. These rod keyways when drilled and chipped by hand usually take from three to five times longer than when they are done by the milling process.

There are other well known operations in railroad shop work which it is believed could be handled with more economy and satisfaction if a little preliminary time was given to the study and working out of the proper equipment and way to do the job. If one is interested, though doubtful, about some particular operation, which may be done by the milling process, a blue print or a sample of work might be sent to a good manufacturer for a guaranteed time and cost estimate of the job. This may save a lot of experimenting and the machine tool makers will be glad to tell what it will cost and how it can be done.

It is always well to remember the following as essential to good results on the milling machine:

Keep the machine in good condition at all times.

Use arbors of as large diameter as possible to prevent chattering and springing away from the work.

If a rigid intermediate support can be used with a bearing close to the cutter, it will be helpful on heavy duty work.

Use high speed coarse tooth cutters of a design to suit the work and make them produce results by keeping them cool by lubrication when cutting steel. Increase the feed in proportion to the speed of the cutter to the limit of finish required.

Good cutters will produce more work and stay sharp longer when used under these conditions.

RECLAIMING AIR PUMP PACKING GLAND RINGS

BY WILLIAM K. CLEARY

Air Brake Foreman, Boston & Maine, Lyndonville, Vt.

When air pump packing gland rings become enlarged by wear, they must be renewed or the pump cylinders will be worn unevenly and piston packing will require frequent replacement.

In order to avoid scrapping the packing gland rings, the following method of repairing them has been adopted by the writer. The old rings are first bored out to an inside diameter of 1 5/8 in. and then three grooves are turned on the inside of the ring, each 1/16 in. deep. Two grooves are then cut longitudinally to the same depth. The rings are then placed flange down, on a smooth surface and a taper plug placed in the center of the bore to form an easily removed

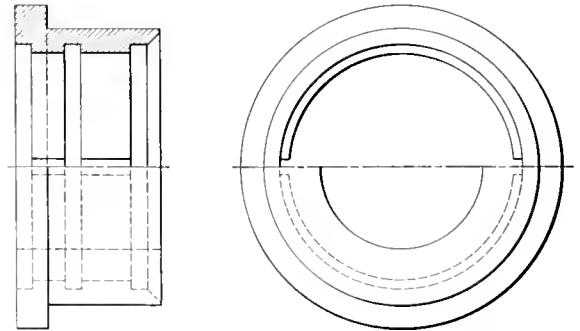

A Packing Gland Ring Bored Out for Babbitting

mandrel, about which is poured a babbitt composed of 80 per cent lead and 20 per cent antimony. The babbitt is then finished to the proper size and the ring is ready for application. The grooves hold it securely.

Packing gland rings have been repaired by this method for about two years. Engines making 50,000 miles have come in with piston rods worn only .002 in. with the surface polished to a perfect gloss. The cost of the repairs is between six and seven cents per ring, which effects a saving of about 20 cents per ring as compared with the scrapping of the old rings and the application of new ones. Whenever the repaired rings become worn, it is only necessary to melt out the old babbitt and reline them to continue them in service.

INCREASED USE OF FUEL OIL.—According to statistics issued by the United States Geological Survey, 5,477,951 barrels, or 15 per cent more fuel oil was used in 1916 than in 1915. The average distance covered by a locomotive per barrel of fuel oil consumed was 3.33 miles.

ROD WORK ON THE CHESAPEAKE & OHIO

Second Prize Article in the Rod Job Competition. Organization and Methods for Handling Rods Described

BY H. M. BROWN

Shop Superintendent, Chesapeake & Ohio, Huntington, W. Va.

THE Huntington shops of the Chesapeake & Ohio are well equipped to handle rod work. The machines are so located that a progressive system of operation is obtained, no delay being encountered in passing the rods from one machine to another until they have been completed. This enables the work to be done at a lower cost than if

separate, so that two machinists are enabled to work on each side of the bench. Below the benches are drawers and suitable cupboards to take care of the tools of the machinists,

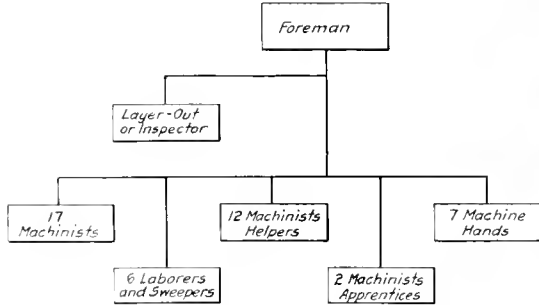

Fig. 1—Organization of the Rod Gang

the machines were placed indiscriminately throughout the shop as the rods do not have to be handled as much. The machine tools employed in the rod work are of the latest design and are particularly adapted to this work.

The organization of the force for handling this work is shown in Fig. 1, and the arrangement of the machine tools

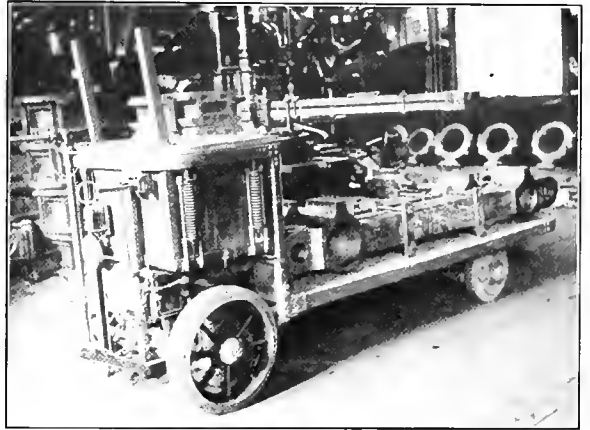

Fig. 3—Motor Truck for Carrying Rods About the Shop

as well as parts for rods that are undergoing repairs. The cleaned and stripped rods, as well as new rods are stored on benches directly behind the lathes used for turning the bush-

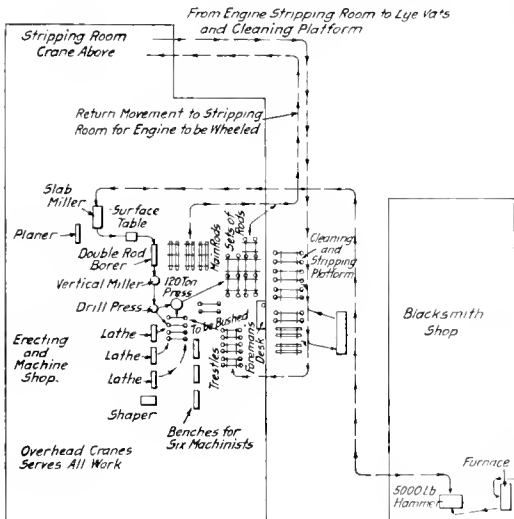

Fig. 2—Arrangement of Machine Tools

is shown in Fig. 2. The path followed by the new and old rods as they pass through the shops is indicated by the arrows. The new rods start from the billet pile just outside the smith shop, and end at the stripping room, where they are placed on the locomotives. The old rods start and end at the stripping room as shown. They are cleaned in a lye vat, of course, before they go into the shop.

The benches are arranged longitudinally and are made

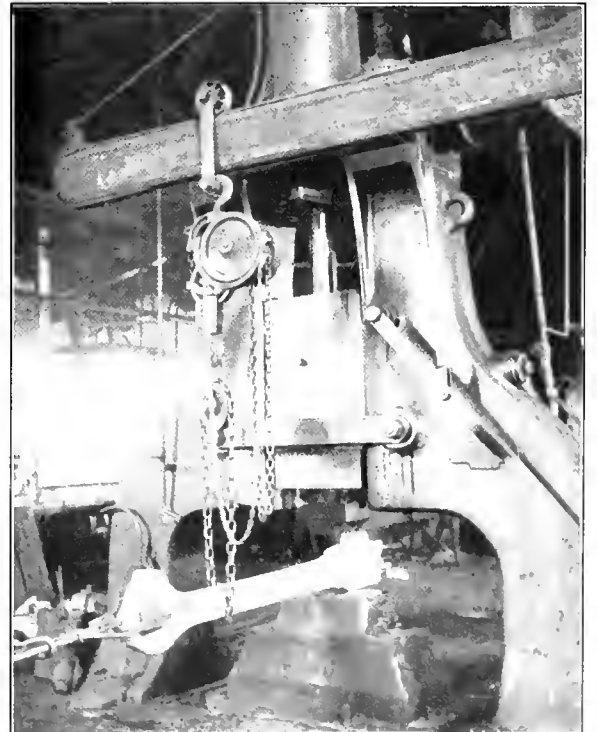

Fig. 4—Forging the Rods Under the Steam Hammer

ings and the shaper for machining front and back end main rods. The cleaned and stripped rods, as well as new rods, are stored on benches directly behind. On all repair work the size of the pins is obtained by the mechanic, who calipers all axles for turning. He delivers the sizes of the

to easily control the temperature and maintain it at a more uniform degree than when either coal or oil is used. The billets are brought to the proper temperature slowly, but at a sufficient speed so that at no time will the billets slough. The proper temperature is determined by a colored glass scale supplied by the United States Bureau of Standards.

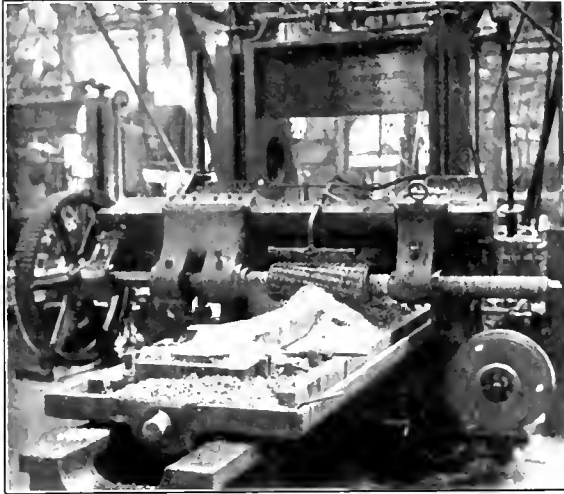

Fig. 5—Finishing the Sides of a Rod on a Slab Milling Machine

axles to the machinist on the boring mill, and the sizes of the pins are delivered to the machinists on the lathes. With this method it is not necessary for these mechanics to lose any time whatever in getting sizes.

A motor truck, shown in Fig. 2, is used for carrying the rods from one shop to another and between the machines, where it is necessary. This truck is capable of carrying two tons and gives excellent service with little expense and practically no delay.

The new rods are made directly from billets which are



Fig. 7—Milling the Ends of the Rods

The billets are then forged to a template under a steam hammer as shown in Fig. 4. The actual time from the receipt of the billet at the blacksmith shop until it is forged to shape is eight hours. After the rods have been forged

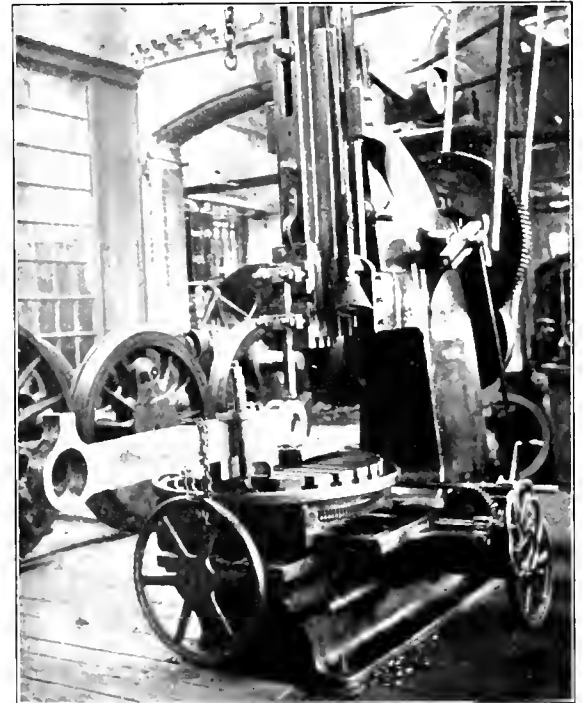

Fig. 8—Slotting the Rods for the Knuckle Joint Connection

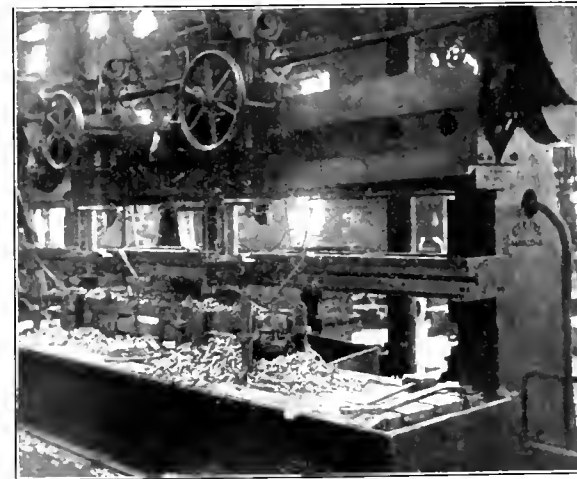

Fig. 6—Boring the Rods on a Double Spindle Boring Machine

purchased in the open market under physical and chemical specifications made by the railroad company. As an order is placed the blacksmith shop foreman selects the proper sized billets. The billets are taken from the pile to the forging furnace by the electric truck. The furnaces in which the rods are heated uses gas which makes it possible

they are set aside and just before the shop closes at night, they are put back into the furnace and allowed to anneal with the cooling of the furnace and in this way relieving all

hammer strain. They are removed from the furnace the following morning and delivered to the machine shop by

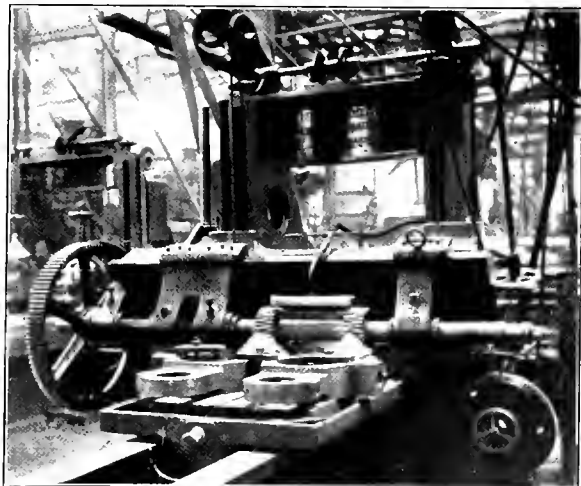

Fig. 9—Fluting the Main Rods

the electric truck. They are allowed to cool throughout the day and night, not being machined until the next morning.

The first machine work to be done is to mill the sides of

the rod. This is done on a slab milling machine as shown in Fig. 5. Both the center and ends are milled. On account of the grease cups which are forged on the rods, it is impossible to get more than one rod on this particular machine, except when the rods are being fluted, where it is possible to allow the grease cup to extend over the side of the machine. After the rods have been milled to size, they are paired and laid off according to a template. From there they pass to the double spindle rod boring machine shown in Fig. 6, the paired rods being bored for the brass fit and the knuckle pin bushing. An adjustable boring tool is used for boring the holes in the rod.

After the rods have been bored, the oil cups and knuckle pin oil cups are drilled, faced and tapped, a skip thread tap being used for this purpose. The ends of the rods are milled in pairs as shown in Fig. 7. The jaw in the end of the side rod for the knuckle connection is made on a slotter as shown in Fig. 8. Fig. 9 shows the method of forming the channels in the rods on the same slab milling machine shown in Fig. 5.

The actual cost of labor and material for finishing a pair of middle connection rods complete for a heavy Pacific type locomotive is \$156.77. The front end and back end of the side rods are handled in pairs in the same manner as described above with the middle connection rods. The cost of manufacturing from the billet to the finished main rod is \$254.57, while the complete cost for a complete set of rods on a heavy Consolidation locomotive is \$624.88, including the brasses.



INTERESTING BACK SHOP PERFORMANCE

Consolidation Locomotive Given General Repairs and External Boiler Inspection in 33 Hours on the D. & H.

THE Delaware & Hudson, at Colonie, N. Y., made an interesting performance a short time ago in putting a locomotive of the Consolidation type through the shop for general repairs in 33 hours. It was one of a class that was in considerable demand, and in this particular case it was desired to turn the engine out with the least possible delay. In addition to the usual general overhauling, the

locomotive was due for its five-year external boiler inspection as required by the Federal government; this requires the complete removal of the lagging.

The locomotive is used in freight service on the Pennsylvania division and is of the following general dimensions:

	<i>General</i>
Gage	4 ft. 8 1/2 in.
Service	Freight

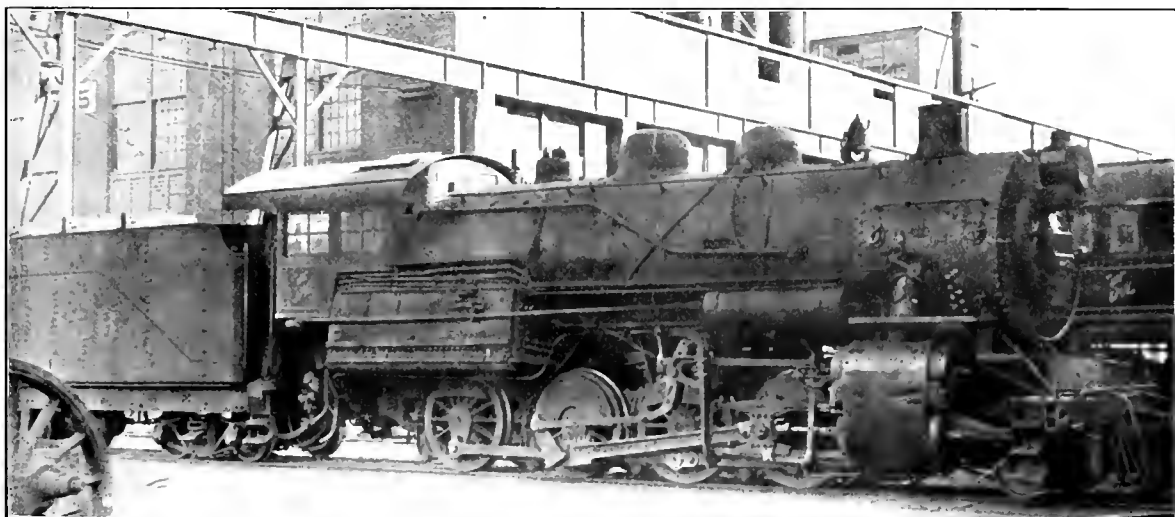

Fig. 1—Photograph of the Locomotive Before the Work Was Begun—7 a. m. Monday

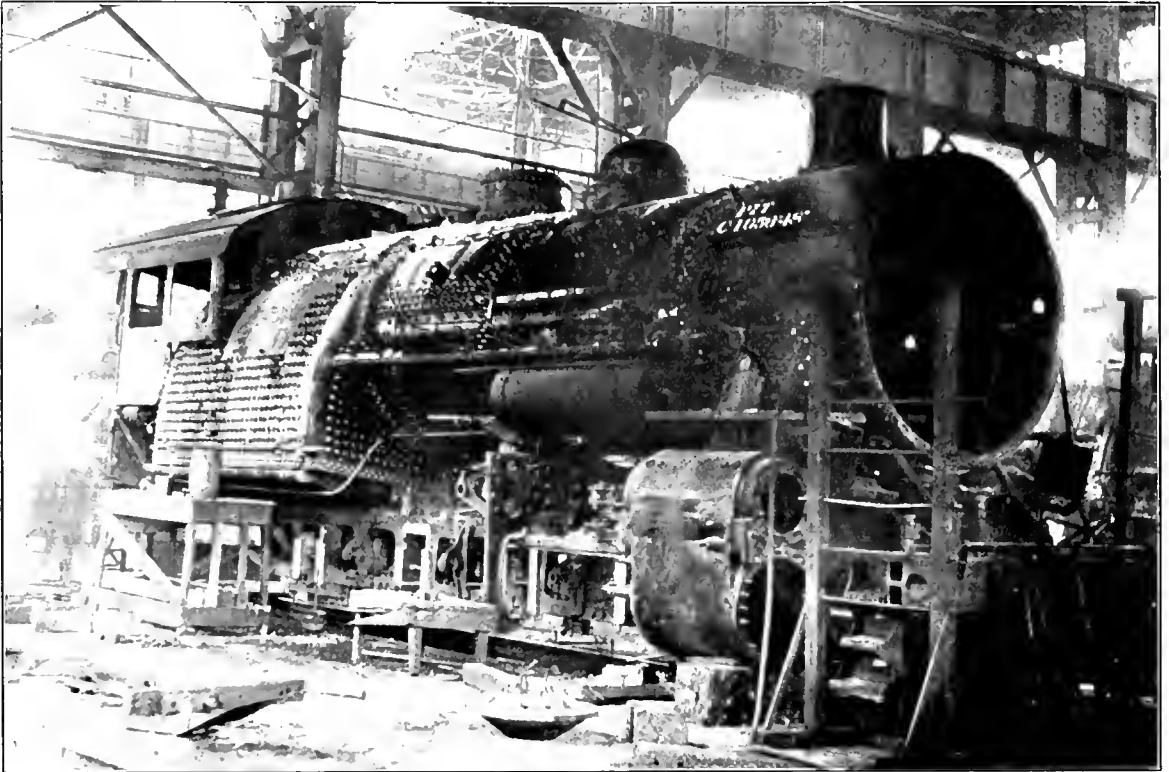

Fig. 2.—Photograph of the Locomotive Two Hours after the Work was Begun.

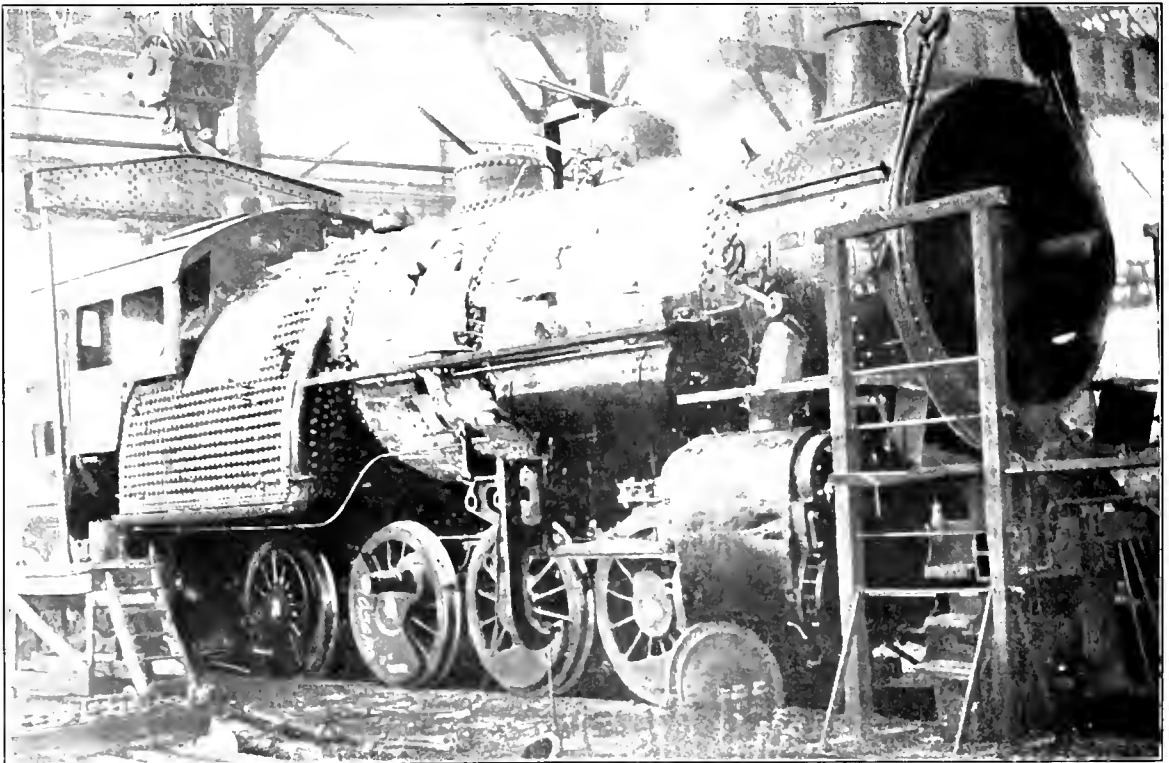

Fig. 3.—Part of the Lagging Applied and the Engine Wheeled at 1 P. M. Monday.

Fuel	Anthracite
Tractive effort	56,900 lb.
Weight in working order	257,050 lb.
Weight on drivers	234,550 lb.
Weight on leading truck	25,500 lb.
Weight of engine and tender in working order	389,417 lb.
Wheel base, driving	17 ft.
Wheel base, total	26 ft. 1 in.
Wheel base, engine and tender	63 ft. 1 1/2 in.

Cylinders

Kind	Simple
Diameter and stroke	28 in. by 30 in.

Wheels

Driving, diameter over tires	57 in.
Driving journals, main, diameter and length	4 1/4 in. by 17 in.
Driving journals, others, diameter and length	4 in. by 13 in.
Engine truck wheels, diameter	30 in.

Boiler

Style	Wootten
Working pressure	200 lb. per sq. in.
Outside diameter of first ring	82 in.
Firebox, length and width	126 1/2 in. by 114 in.
Tubes, number and outside diameter	275—2 in.
Flues, number	38
Tubes and flues, length	14 ft. 6 in.
Grate area	100 sq. ft.

The locomotive was received at the shop cold on a Monday at 7:00 a. m., as shown in Fig. 1, the photograph being

been removed, the locomotive was completely stripped, the lagging and jacket were removed entirely, the wheels were dropped, the superheater units removed and the boiler was ready for the first test. The valves were also out, the bottom guide bar removed and new shoes and wedges were applied ready to be laid out. Immediately after the superheater units were removed, the work of removing the large superheater flues was begun. The locomotives in the district in which this locomotive operates usually have but very little difficulty with scale in the boiler, but on this particular engine the superheater flues were so scaled that it took until 6:55 p. m. to remove the entire thirty-eight.

The third picture was taken at 1:00 p. m. on the same day, and is shown in Fig. 3. It will be observed that the boiler has part of the lagging applied. The spring rigging was also reapplied. The boiler had been given its test and the wheels applied. The wheels were placed under the engine during the noon hour at a time when the least disturbance would be caused to the rest of the workmen and

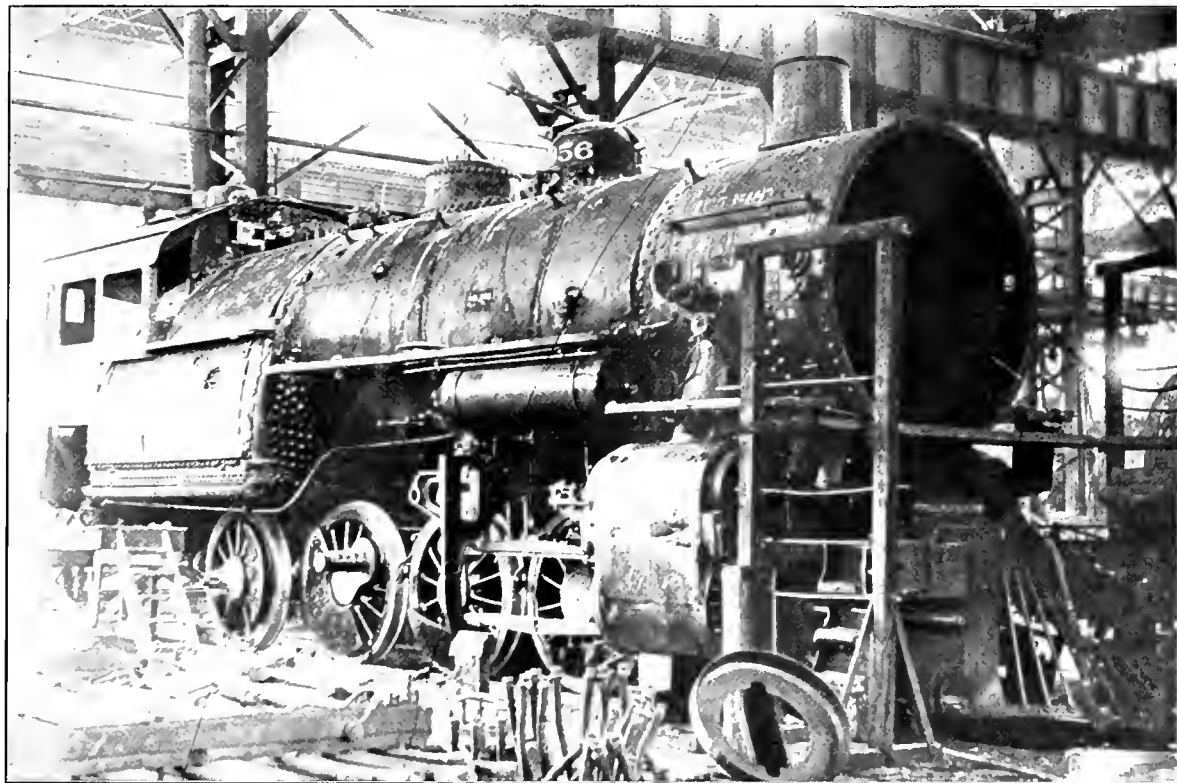

Fig. 4—The Locomotive at 5 P. M. Monday

taken on the wash track. The following is a schedule of the principal work that was to be done on it:

- Full jacket and lagging removal
- Tate caps removed of which there were between 1,200 and 1,300
- Superheater flues removed
- Small tubes rolled and propped
- New shoes and wedges
- New driving brasses
- Tires turned
- Lower guides planed and ground
- Crosshead rebabbitted
- New rod brasses
- Main and side rods and drawbar annealed
- Air brake equipment overhauled
- Throttle ground

The next picture of the locomotive was taken at 9:00 a. m. of the same day, and is shown in Fig. 2. Between seven and nine o'clock the boiler front and the netting had

the crane could be spared best. This work is usually done by the night shift. The practice at this shop is to provide a full set of spring rigging for application to the locomotives as they pass through the shop.

The locomotive as it appeared at 5:00 p. m. on this same day is shown in Fig. 4. The lower guides are back in their place, having been planed and ground, the lagging has been applied and the jacket is in place. The heads of the Tate staybolts have been removed and replaced, and all the staybolts examined. As stated above, the flues were removed at 6:55 p. m. The new ones were applied complete in 1 hour and 25 minutes after the old ones had been removed. During the night the superheater ball joints were ground and units replaced. The front end netting was put in position, the side rods were hung and a large amount of the piping

was reapplied. The crosshead and cylinder heads were applied. The appearance of the engine at 7:00 a. m. on Tuesday is shown in Fig. 5.

The rest of the work was done between 7:00 a. m., when

etc. The valves were squared by moving the locomotive by a smaller engine. The boiler was washed out and was filled with hot water and fired up in about 30 minutes. The engine was in the hands of transportation department at

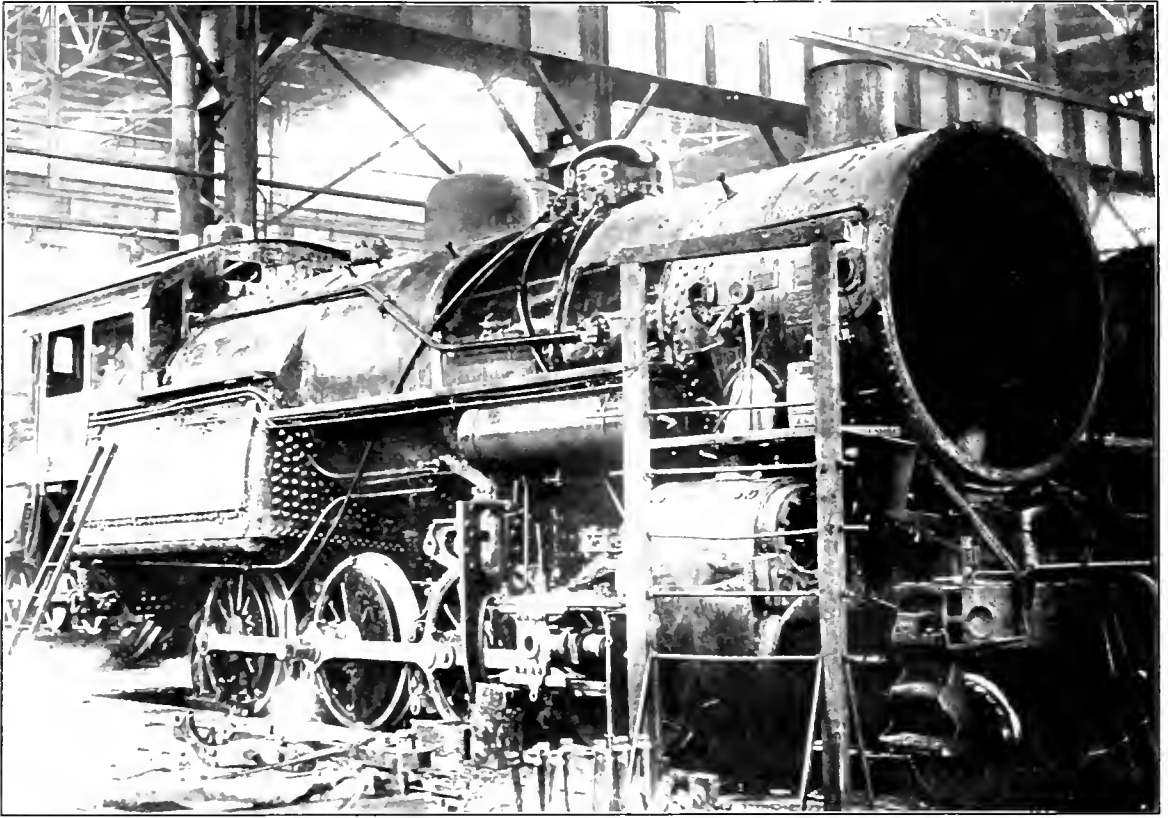

Fig. 5—The Locomotive as it Appeared at 7 A. M. on Tuesday.

the day force again took the engine, and 12:30, at noon, when it was finished complete, fired up for the testing crew. As will be seen from a close examination of Fig. 5, the work

4:00 p. m. on Tuesday, just 33 hours after it was received at the shops. The photograph shown in Fig. 6 was taken when it left the shop. The regular shop forces were used on this

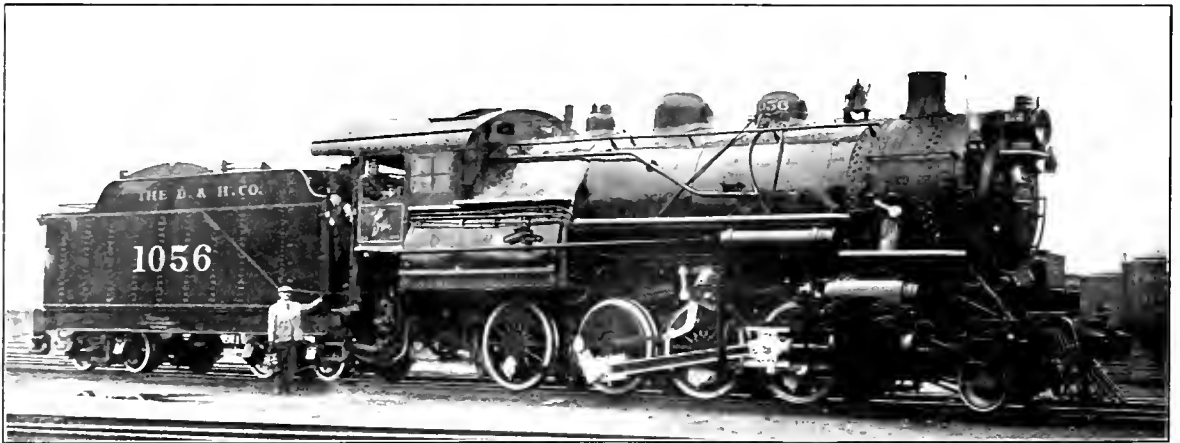

Fig. 6—Locomotive Ready for the Transportation Department at 4 P. M. Tuesday.

done during this period consisted of applying the main rods, applying the motion work, crank pins, extension piston rods, crossheads and guides, cab fittings, brake connections, pops,

engine and a little overtime was paid to get the engine out as soon as possible, but with the night force, which is common to this shop, very little overtime was required.

The practice at this shop is to have as much of the material as possible ready for a locomotive before it comes to the shop. An advance report is submitted for every locomotive so that the material will be ready for application. The shoes and wedges and the spring rigging are made up in advance from new material so that they can be applied immediately. A shop schedule system is used in this shop. The performance described above is a very special case, as it was desired to release the engine as promptly as possible. Preparing material for application in advance has helped a number of shops on other roads to considerably cut down the time that locomotives are in the shop.

HANDLING ROD REPAIRS*

BY JAMES GRANT
Great Northern, St. Paul, Minn.

The rod department of the Dale Street shops, St. Paul, of the Great Northern, is located in a building entirely separate from the machine and erecting shop. It adjoins the wheel or stripping shop, and a gang of machinists consisting of four bench hands, five machine hands, one machinist apprentice and one helper constitutes the force. One

one Lodge & Shipley engine lathe with a 24-in. swing and a 10-ft. bed, and one 50-ton hydraulic press. These machines enable the rod gang to do practically all its own machine work, thus making it an independent unit from the machine shop.

Locomotives coming to these shops for repairs are first stripped in the wheel or stripping shop. The rods are then cleaned and trucked into the rod shop, where they are stamped for identification and examined for any defects. It is a standing practice on this road to anneal all rods when an engine goes through the shops, so after all the brasses and bushings have been removed, the rods are trucked to a large annealing furnace located in the boiler shop, which also adjoins the rod shop.

After being annealed the rods are brought back to the rod shop for repairs. If a rod brass strap is found to be worn above the standard size, it is taken to the blacksmith shop and closed just enough so that it can be machined again to the standard dimensions. This practice always keeps the straps to a standard opening, so that when a brass is to be replaced outside the main shop, a new one can be readily obtained through the storehouse properly machined and practically ready to apply. This is a great help at small

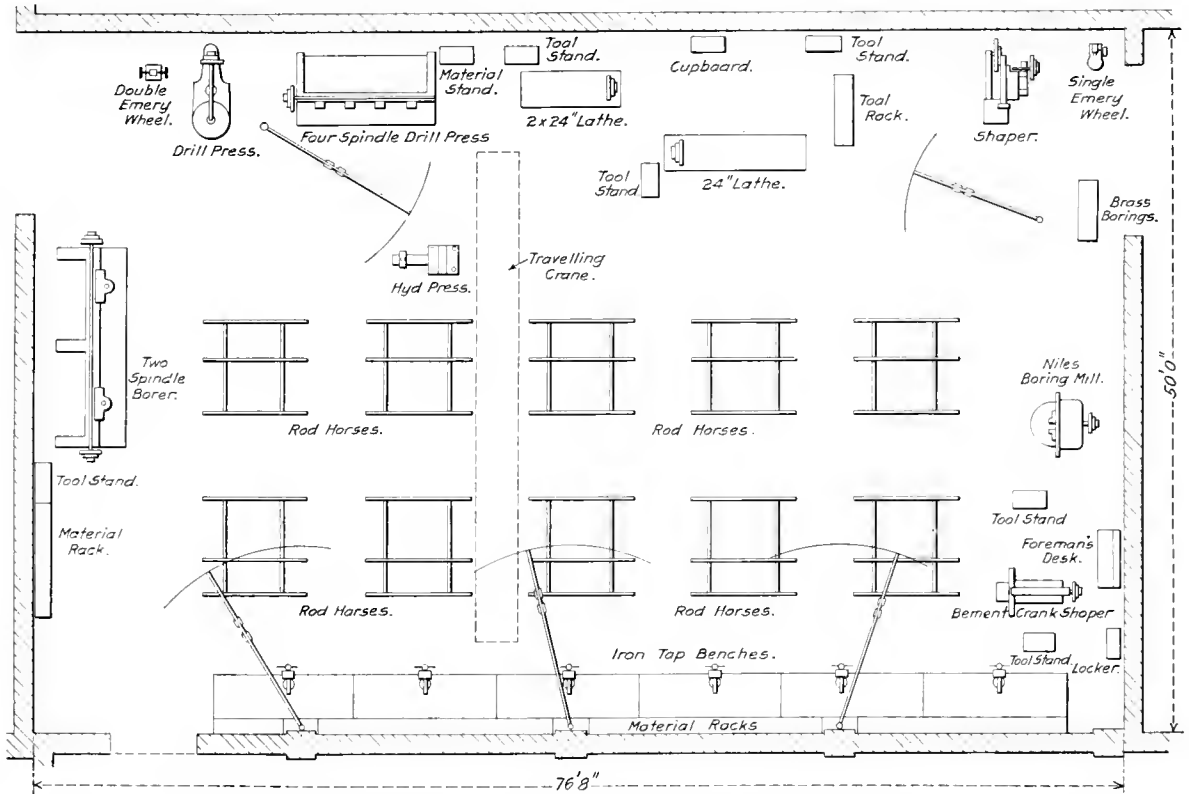

Arrangement of Machine Tools for Rod Work at the Dale Street, St. Paul, Shops of the Great Northern

of these machinists supervises the work and is called the "leading hand." These shops turn out an average of 35 locomotives per month, and this gang handles the rods for all of them.

The following machines are located in the rod shop: One Newton 2-spindle rod boring machine, one 20-in. by 2½-in. double emery wheel, one 42-in. Niles vertical boring mill with two heads on the cross rail, one 26-in. Morton draw cut shaper, one 2-in. by 24-in. Jones & Lamson turret lathe, one 13-in. column shaper, one 4-spindle drill press,

roundhouses, which have not got the machine facilities. Many roads just fit the brasses to suit the straps irrespective of whether the strap fit is worn to larger than the standard dimensions. In this case, when a brass is changed, it is often found necessary to insert a liner in order to keep the brasses tight in the strap. All rods are very carefully examined after annealing for any signs of cracks or warping.

All machine work pertaining to rod overhauling is done in the rod department, with the exception of making the crosshead pins. This work is taken care of in the machine

* Awarded third prize in the Rod Job Competition which closed May 1.

shop. If it is found necessary to true up the knuckle pin or bushing holes, this work is done in the rod boring machine, and special care is taken to always keep exact centers. Rod bolts are all machined in the Jones and Lamson turret lathe, and all bushings are machined in the vertical boring mill working both heads, turning and boring the bushing at the same time. The bushings are pressed in by hydraulic pressure.

The first operation in machining the brasses is to take a cut from both halves. They are then sweated together in order to facilitate machining. The strap fits are made on the draw cut shaper. The brasses are then fitted in the strap, which is bolted on its own rod, and securely keyed in position. The operation of boring and facing is then performed on the rod boring machine and is completed with one setting. This is considered to be the only perfect way to bore brasses, as it eliminates any danger of a twist and keeps the bore at each end of the rod in perfect alinement. The front and back end main rod brasses are handled the same way.

No brasses are scrapped if they are found still to be in condition for further service. Sometimes all that is needed is to take up a little lateral, which is done by riveting on a brass liner. This reduces them enough to allow for re-boring. They are always put in the rod and bored and faced on the rod boring machine. It is quite a common habit for machinists to scrap all brasses and order an entire new set every time an engine goes to the shop, thereby, entailing a lot of unnecessary expense. The leading hand in this department examines all old brasses and determines if it will be profitable to use them again.

When all the machine work has been done and the bolts and wedges have been properly fitted, the whole set is put together with knuckle pins applied and are carefully trammed. If a rod is found to be long or short, this defect is remedied before leaving the department. Every rod must tram to gage, and the length over the entire set must be exactly to standard dimensions. After carefully checking the rods, they are then taken down and are ready to apply to the locomotive. The rods are applied by the gangs on the erecting floor, as the rod men never leave their own department. All crank pin sizes are brought to them, and everything is worked to gage as near as possible. A keeper screw is applied in all rods to prevent the bushing from turning in the event that it works loose, thus always ensuring lubrication from the grease cup.

All the grease cups are carefully gone over and overhauled by the rod department also, and care is taken to see that proper grease channels are made in order to lubricate the crank pins.

When the rods are all set up to standard lengths it is unnecessary to trouble with "spotting" and "plumbing" the crank pins when the rods are applied, and they can be slipped on in most any position. If they don't connect then the locomotive is either out of tram or there is something wrong with the pins.

New rods for the entire system are also handled by this department. The machine work on new rods is done in the machine shop, where the slab and vertical millers are located, but all laying out, fitting up, and boring brasses and bushings for these rods is done in this department.

While the foregoing methods may not be the least expensive for handling rods, it is considered to be one of the most thorough and practicable. Rod trouble is one of the smallest sources of worry on this road, and care in overhauling them certainly is a decided factor towards eliminating these troubles.

LIBERTY LOAN SUBSCRIPTION.—In the recent drive for the purchase of Liberty bonds, 73 per cent of the men in the Colonie shops of the Delaware & Hudson subscribed.

RECLAIMING CAST IRON WHEELS

Chilled iron wheels with slid flat spots are now being reclaimed with success on one of the large western roads by grinding the tread of the wheel until the flat spot is ground out. During the past year the price of chilled iron wheels has advanced approximately 80 per cent and the differential per pair of wheels is now more than \$6. As the cost of grinding is less than 60 cents a pair the method effects a very large saving.

Before the practice of grinding car wheels was adopted an investigation was made to determine the average depth of chill in the wheels. The inspection showed that it varied widely and instructions were issued that the wheels made by certain manufacturers were not to be ground as it was found that the depth of chill was not great enough to permit it. At the present time system wheels with flat spots up to $3\frac{1}{2}$ in. in length are ground, and wheels of foreign roads with flat spots up to 3 in. in length. The longest flat spots are ground out of the wheels which are comparatively new and of the smaller tape sizes, since the small wheels always have the greatest depth of chill. The average chill of a good quality wheel is usually about $\frac{1}{2}$ in. and since a flat spot $3\frac{1}{2}$ in. long represents a depression of only .095 in. from the normal contour of the wheel it will be seen that a considerable depth of chilled metal remains after grinding. It has been found difficult to determine the original tape size, since the painted marks are often obliterated and at the present time all wheels for this road are cast with five projections and the tape size is shown by chipping off some of them.

No wheels having shelled out spots or with tread which has been brake burnt are reclaimed. Wheels which are suitable for grinding are shipped to the nearer of the two points on the system where the grinding machines are located and after being ground are placed under system cars at those points. In order that the performance of the wheels may be watched after grinding the place where the work is done and the date are stamped on the plate of the wheel. From one to two hundred pairs of wheels are reclaimed every month and the records show that a very good performance is secured from them after grinding. Since each pair is exactly mated and there is no eccentricity in the wheels which have been ground the tendency toward flange wear is less than in the case of new wheels.

The cost of reclaiming wheels by this method is in detail as follows:

Interest, depreciation and repairs to machines, per pair.....	5 cents
Power per pair, at $1\frac{1}{2}$ cents per K.W. hour.....	15 cents
Grinding wheels, per pair.....	12 cents
Labor and pro rata, per pair.....	25½ cents
Total	57½ cents

The life of the abrasive wheels used on this work varies somewhat. The number of wheels which each one grinds ranges from 100 to 175, the average being about 125. Since car wheel grinders are located at only two points on the system it is necessary to ship wheels which are to be reground greater distances than those which are renewed. No reference to this extra cost has been made above as it is offset by the fact that when the wheels are reground it is not necessary to press them off the axles and rebore and remount them, as is the case when new or other wheels are applied.

FLAWLESS AND HOMOGENOUS STEEL CASTING.—A 60-in. rotor weighing 10,000 lb., which was recently installed in a large ocean-going yacht as part of a Sperry gyroscopic stabilizer, was made of cast steel. So perfectly was the steel cast that after machining it was found that no balancing was required.

EMERGENCY INJECTOR REPAIRS

BY F. W. BENTLEY

Not long ago the steam valve and priming nozzle of a No. 11 Nathan non-lifting injector was found to be broken on a locomotive which was about to leave the roundhouse at a small engine terminal where no spare parts were available for making the repairs.

The size of the steam opening through the nozzle and valve

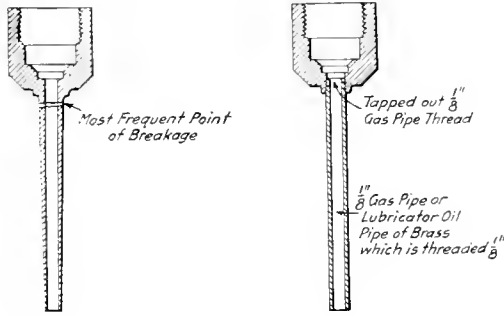

Method of Making Emergency Repairs to an Injector Priming Nozzle

is such that the hole may very readily be tapped with a 1/8-in. pipe tap. A piece of 1/8-in. brass oil pipe from an

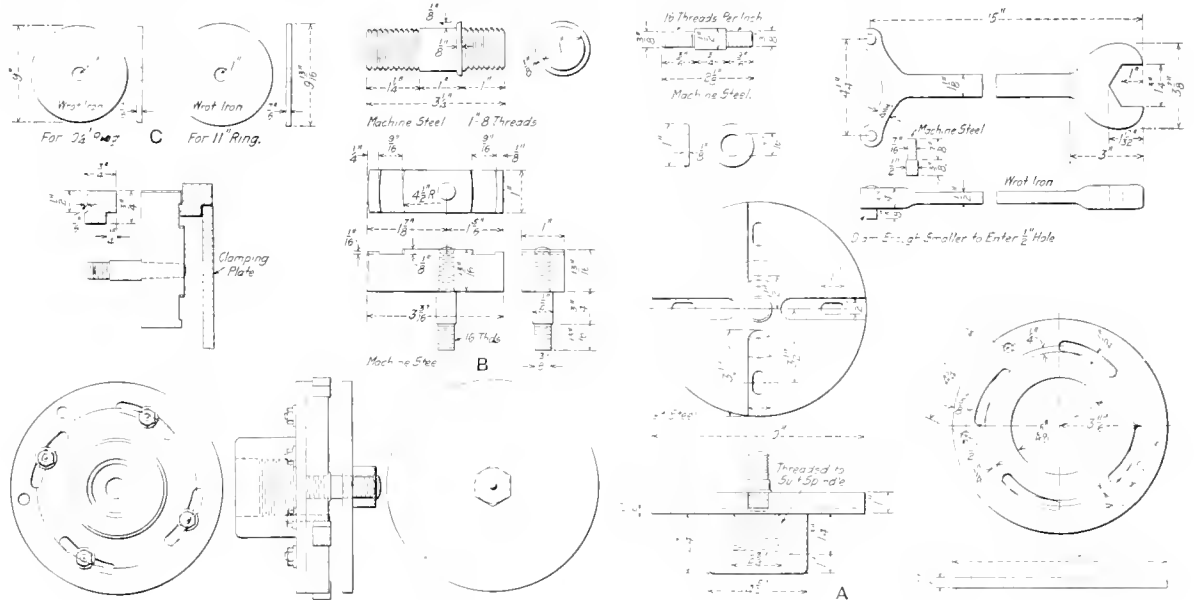

Details of the Packing Ring Chuck

CHUCK FOR FINISHING PISTON VALVE PACKING RINGS

The drawing shows the details of a chuck which was designed by T. B. Baldwin, superintendent of shops, New York, Chicago and St. Louis, at Conneaut, Ohio, for finishing piston valve packing rings with diameters 10 1/4 in. and 11 in. The rings are first roughed out and sawed before being finished in the chuck.

The base of the chuck is shown at A and may be designed to fit any lathe spindle. It is provided with four radial slots through the bottom of each of which is an oblong hole 1 1/2 in. wide by 1 in. long. A stud is tapped into the center of the plate. The clamping jaws are shown at B. These are placed in the slots in the chuck's base with the 1/2-in. studs passing through the holes in the bottom of the slots and are held in place by nuts on the end of the studs. The adjustment of the jaws is effected by means by a 11 16-in. steel disk, having four eccentric slots through its base. This is placed against the back side of the base plate with the jaw studs extending through the eccentric slots. The adjustment is obtained by turning the plate about the spindle boss on the back of the base of the chuck, two 5/8-in. holes in the plate being provided to fit a spanner wrench shown in the drawing. With the ring in place in the jaws, as shown in the sectional sketch, the clamping plate A is placed over the stud in the center of the base and after the ring has been tightly closed by closing in the clamping jaws, the plate is

emergency lubricator was cut to length and after tapping out the body of the broken valve was screwed firmly in place. Although a new part was ordered, the improvised nozzle end is still in service and is performing very satisfactorily. The repairs were made in a very few minutes with tools that are almost universally available. At small points where the stock of repair parts is necessarily small, this method of repairing these broken parts is entirely satisfactory for use in emergency.

THE CEMENT GUN.—It is reported that the cement gun has been used with very satisfactory results for the application of a cement lining 1 3/4 in. thick to the interiors of five large steel stacks built for the Ford Motor Company.

drawn down tight with the nut on the spindle stud. After the jaws have been properly adjusted, the nuts on the back of the adjusting disk are drawn up tight.

CANADIAN RAILWAY FUEL.—It is expected that the coal bill of the Canadian railways will show an increase of more than \$8,000,000 this year. One purchasing agent is quoted as saying that the increase in the price of railway coal will range from 75 to 150 per cent over last year's price. In addition, the Canadian lines must carry a burden in the form of a 7 1/2 per cent duty on the coal imported. A very large proportion of the coal used on the Canadian railways must be bought from the United States.—*The Engineer (London).*



DUPLEX LOCOMOTIVE STOKER

A new type of mechanical stoker which is designed to extend the field in which such devices can be used has been placed on the market by the Locomotive Stoker Company, Pittsburgh, Pa. This stoker, which is known as the

The Duplex Type D stoker consists of a conveyor and crushing system, an elevating system and a distributing system, the entire mechanism being driven by a simple reversing engine. The travel of the coal through the stoker is as follows: The shoveling sheet is provided with an opening 18 in. wide extending from the coal gates to the slope sheet of the tender. The opening is covered by slides, each measuring about 20 in. in length. After passing through this opening to the trough beneath, the coal is conveyed by the conveyor screw through the crusher, where it is forced



Cab View of a Locomotive Equipped with the Duplex Stoker

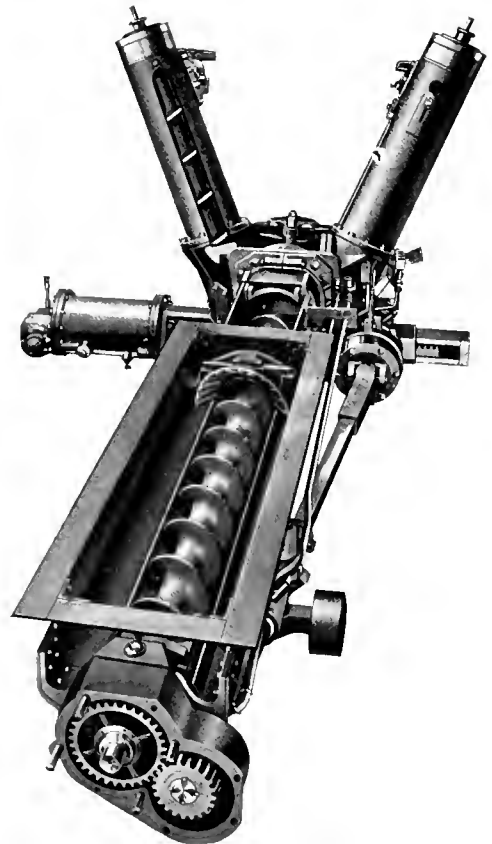

Assembled View of the Duplex Locomotive Stoker Detached from the Locomotive

"Duplex Type D," includes many features of the Street Type C stoker, and, in addition, has a crusher which will handle lump coal, thus doing away with the necessity of specially prepared coal for stoker engines. It is claimed that the crusher will handle the hardest of hand fired coal, reducing it to the proper size before delivering it to the fire-box. It will also handle slack coal as well as lump. The stoker occupies little space in the cab and is practically noiseless. Like the Street, it does not take up any of the grate area, nor does it obstruct the fire-door.

against the crusher plate by the screw and broken to a suitable size. The coal is then carried to the transfer hopper, where it is divided equally or unequally according to the position of the dividing rib between the two elevators. In

the elevator casings are screws which raise the coal and allow it to drop into tubes which are fitted into elbows and extend through holes in the backhead on each side of the fire-door. Constant steam jets in the elbows blow the coal through the tubes and distributors located on the inside of the fire-box deflect and spread the coal over the entire surface of the fire.

The conveyor consists of a wrought steel trough in which is a cast steel screw and a crushing plate. The screw is driven by gears at the rear end of the conveyor trough through a driving shaft secured along the outside of the trough on the right. The trough is supported under the shovel plate by two angles riveted on each side of the conveyor conduit which forms bearings for rollers fitted on the arms of the conveyor slide support. This support is permanently secured to the bottom of the trough about 3 ft. from its rear end, thus providing flexibility to take care of the movement between the engine and tender. The lower angle bearings extend almost to the front of the tender and form a track on which the trough rolls when being removed from the tender. The conveyor unit moves with the engine, merely resting on the angle bearings in the tender, but when the engine and tender are parted it can be uncoupled from the transfer hopper and left with the tender. An angle ring fits into and around the top of the trough, preventing dust from blowing into the tender tank and coal from rolling over the sides of the trough.

The conveyor driving shaft is in two parts; a gear shaft, which is connected to the conveyor drive gear, and a flexible connection by which it is joined to the conveyor drive and

efficient firing, and go on to the transfer hopper. The conveyor is flexibly attached to the hopper by means of a ball joint permanently riveted to the trough and fitting into clamps bolted to the back of the transfer hopper.

The transfer hopper is a large casting secured to the engine frame beneath the cab deck. The rack housing is bolted to the front bottom portion of the hopper and the elevator cas-

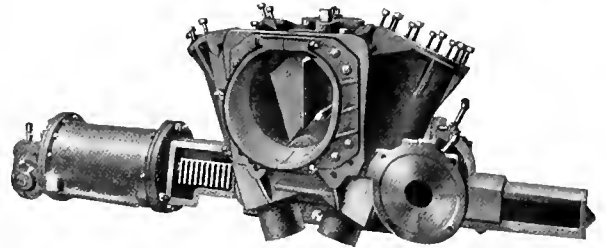

Driving Mechanism of the Duplex Locomotive Stoker Showing the Vance for Distributing the Coal to the Vertical Screws

ings are bolted to the top. At the bottom are bearings for the right and left elevator driving shafts. Secured to the front on a pivot inside the hopper, and dividing the coal coming through the front trough opening, is a dividing rib which can be operated through an opening in the cab deck. By turning this rib to the left or right the supply of coal to either side may be controlled.

There are two elevators raising the coal to the distribu-

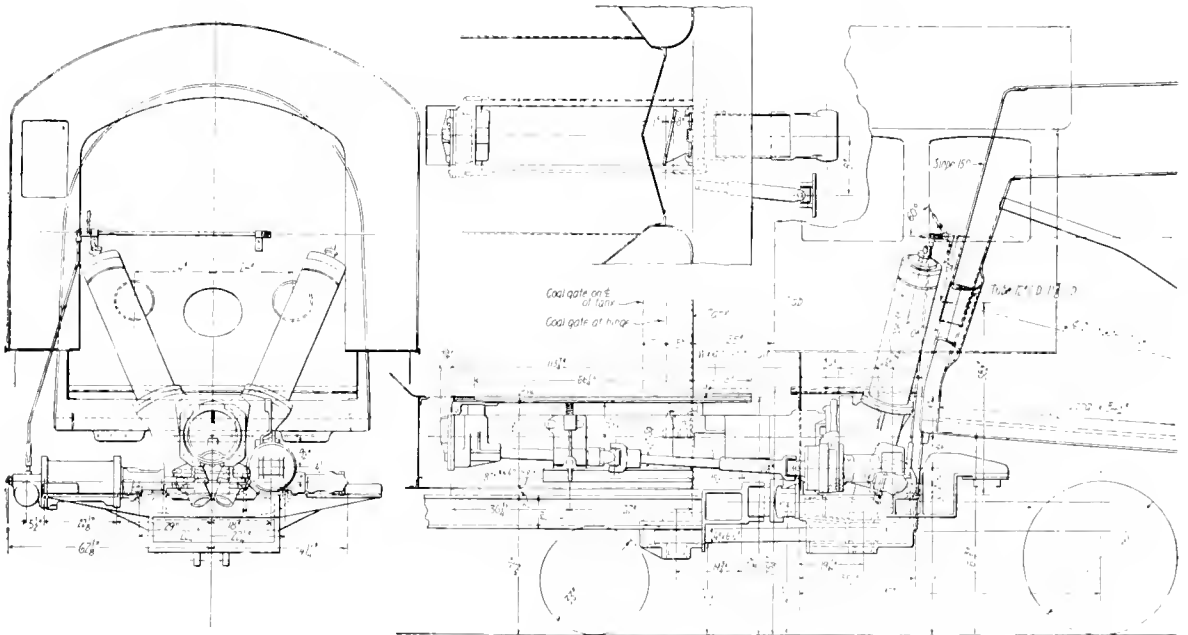

Arrangement of the Duplex Stoker as Applied to a Locomotive

reverse shaft. The flexible connection consists of a sleeve and a shaft with universal joints. The square shaft fits loosely into the sleeve, thus furnishing the flexibility in the conveyor shaft made necessary by the movement between the engine and tender. The crusher is at the front end of the opening in the tender deck, and consists of a heavy plate with projections, set in a slide in the trough. The smaller sizes of coal are carried through without crushing or breaking, but the larger lumps are forced against the crusher plate by the conveyor screws and are broken to the proper size for

tors, one on each side of the fire-door. The elevator driving shafts extend from a bearing in the bottom of the transfer hopper through the top of the elevator casing and reverse. On the bottom of the shaft is a gear which meshes with the vertical teeth of the rack which drives the shaft. The elevator drive and reverse mechanism is on the same principle as the conveyor drive and reverse, which will be described later, but has two sets of pawls and springs. It has three positions, drive or normal position, in which the elevator raises the coal; neutral position, with the elevator screw

stationary; and reverse, with the screw reversing and allowing the coal to return to the transfer hopper.

The spreading of the coal in the firebox is accomplished by means of the two firing points at the openings through the backhead of the boiler. The fire-door is left undisturbed so that it can be used for hand firing at the roundhouse and on sidings or when drifting. Two elbows, in which firing nozzles are secured, are bolted to the elevator casing. Distributors and tubes combined are attached to these elbows, the tube extending through the openings in the backhead and the distributor, being on the inside of the firebox. The distributor tubes serve as a firing plate and the coal is blown through the tubes on to the underside of the distributor by jets of steam admitted to the firing nozzle. An intermittent action is secured through a constant steam jet and the stopping of coal elevation during the return stroke of the driving engine piston and rack. Peep holes are provided through which the coal supply and the condition of the fire can be observed.

The driving engine consist of a cylinder of 11-in. bore and 17½-in. stroke with a hollow piston rod and reverse head. The pressure of the steam used by the engine varies from 8 to 80 lb., according to the quality and size of the coal. The pressure is indicated by a special steam gage on the backhead of the locomotive. In normal operation the piston has a power stroke in one direction only, when the piston is traveling toward the center line of the locomotive and the entire stoker mechanism is in normal operation. On the return stroke of the piston the conveying mechanism is normally stationary, but when any of the screws are reversed by means of the reverse mechanism, the return stroke of the piston becomes temporarily a power stroke. The operation of the cylinders is controlled by a reverse head almost identical with the reverse used on the Westinghouse 11-in. air compressor.

The piston rod in the engine cylinder is screwed into a rack which operates the main driving gears. The stroke of the engine is cushioned at either end by steam. In case the stoker becomes clogged or it is desired to reverse it for any reason it can be done by moving the operating rod located on the backhead of the boiler. The return of the operating rod handle to the central position causes the driving engine to resume its normal operation.

The inner cylinder head is cast integral with the housing for the rack. This is a steel forging with teeth cut in the horizontal side which meshes with and drives the conveyor shaft and reverse gear. Another bar of forged steel riveted to this main rod in which teeth are cut in the back space meshes with and drives the shaft on the lower end of the two elevator screw shafts. Removable covers makes the rack accessible at all points.

The conveyor drive and reverse connects the universal joint with the driving rack. Near the front end of the drive shaft is secured the main gear which meshes with the horizontal rack. The drive and reverse body is fitted on a bearing on the shaft next to the ratchet, which is keyed and pressed on the extreme rear of the shaft. On the other side of the drive and reverse body head a joint jaw is cast which connects by a pin with a block in the front universal joint of the flexible connection. A shifter on the drive and reverse body controls the shifting fingers which are set between the three sets of pawls. A shifter lever controls this conveyor drive and reverse which has three positions, drive or normal position, with the stoker running; neutral, with the conveyor screw stationary while the stoker is in motion; and reverse, with the conveyor screw reversing and pulling back the coal instead of letting it go forward. The conveyor drive and reverse units are protected by cast iron casings.

The pressure of steam on the steam jet under working conditions varies from 10 to 25 lb. The distribution is

regulated by varying the pressure, which is indicated by a steam gage on the backhead of the boiler, and also by changing the position of the dividing rib. The amount of coal fed can be regulated by varying the speed of the engine. Stokers of this type have been operating successfully for several months and a large number have already been ordered for application to locomotives now being constructed.

BLUE SIGNAL SAFETY DEVICE

The importance of the blue flag, which is used to protect the workmen while repairing cars, should never be underestimated. Any disregard of this signal is liable to cause injury and sometimes death to the men who find it necessary to go under the cars to make the required repairs. The arrangement ordinarily used for protecting such cars consists of a blue flag which is more or less carefully stuck into a tie or into the ground. Often this signal is either knocked down by the wind or by some careless employee, thus offering no protection to the string of cars on which the work is being done. In winter it is difficult to place it in position so that it will remain fixed. Sometimes switchmen will take a chance, remove the flag and place a car on the repair track.



Blue Signal Safety Device Being Applied

This, of course, is contrary to the rules and should never be allowed.

In order to provide a signal which will give ample and positive protection, the Acar Manufacturing Company, 30 Church Street, New York, has recently placed on the market a signal standard which cannot be removed except by the proper authorized person. As shown in the illustration, this blue flag standard is clamped and locked to the rail and can only be removed by the man who carries the key for the lock and when once put in position, it will remain in place. The clamp which fits over the rail is made to fit the shape of the rail and can be applied to rail sections weighing from 56 to 100 lb. The arms of the clamp are riveted together and telescoped in the body of the standard which is a piece of pipe. The upper part of these arms extend out through a slot

in the pipe and the arms are of such shape that as the standard is raised they will open the clamp. As the standard is lowered the clamp grips the rail and holds the standard in an upright position. The eye in the upper end of the arm which extends out through the slot in the pipe will then line up with an eye in the lug on the pipe body so that the standard may be locked in position.

Any kind of a target may be used in the standard. The one shown in the illustration is painted blue with the words "Car Inspector" lettered on it. A hook is provided for a lantern when the standard is used at night. This device is



Blue Signal Safety Device Set in Position

made of substantial material and can be used for a variety of other purposes, such as marking train tracks in passenger stations, protecting team tracks and in any other places where cars are spotted and are not to be disturbed.

MURRAY KEY ATTACHMENT

A new design of draft gear key attachment has been placed on the market by the Keyoke Railway Equipment Company, Chicago, Ill. The device consists of two slotted links outside the draft sills at each end of which are placed draft keys of the usual standard dimensions. The front draft key passes through the coupler and draft lugs while the rear key passes through a key housing which fits in a recess in the rear integral draft lug casting. The slots in the front draft lug castings are of such a length that when the limit of capacity of the draft gear is reached the front key takes a bearing on the lug. This relieves the side links and draft keys of all stresses in excess of the cushioning capacity of the gear. It is intended that a coupler with extensions at the rear of the key slot be used with this device, thus changing the stresses on the front key from bending to compression when the key comes in contact with the front draft lugs.

The rear draft key has a bearing in the key housing for the full distance between the draft sills, which reduces the force tending to bend the key. Sufficient clearance is allowed in the slots in the draft lugs and links so that when

the draft gear is closed under compression there are no stresses on any of these members. The draft keys and side links are made of rolled steel, while the front and back draft lugs and key housing are of cast steel.

The following advantages are claimed for this type of

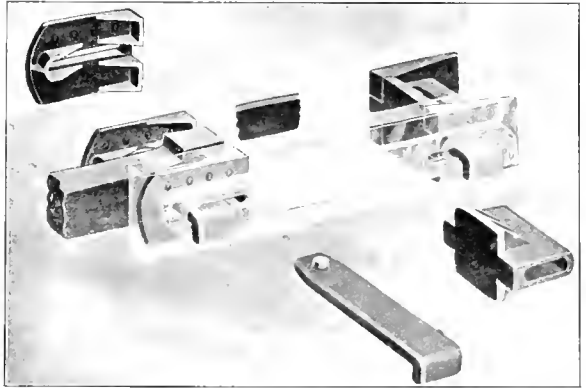

New Design of Keyoke Draft Gear Attachment

construction: It eliminates the bending of draft keys. It permits of using all the space between the draft sills for draft gear. It provides for tying the draft sills together at the rear of the draft gear where buffing shocks are transmitted to the underframe. It facilitates the application of either the draft gear or the key attachment and makes it possible to remove or replace either without disturbing the other. It permits of quick removal or replacement of the coupler. This attachment can be designed to accommodate any type of friction draft gear which is placed wholly between the sills.

POSITIVE LOCKING POWER REVERSE GEAR

During the 1916 conventions of the Master Mechanics' and Master Car Builders' Associations at Atlantic City, a power reverse gear provided with a positive friction lock was exhibited by the Pittsburgh Locomotive Power Reverse Gear Company, Pittsburgh, Pa., and a description of the gear was published on page 1440 of the June 19, 1916, issue of the *Daily Railway Age Gazette*. Since that time the operating mechanism of the gear has been materially altered in order to simplify the cab equipment.

In the original design the movement of the rotary valve, which controls the admission and exhaust of air from the operating cylinder and lock chamber, was controlled by an arrangement of two sliding bars placed in the cab. To the upper bar was attached the operating handle. On the upper face of the lower bar were provided two rollers which worked in a double offset longitudinal slot in the upper bar, causing a lateral movement of the lower bar when the upper bar was moved longitudinally. The lateral movement of the lower bar actuated the rotary valve. The lapping of the valve, which automatically released the air pressure from the operating cylinder and admitted pressure to the chamber above the locking diaphragm was brought about by the longitudinal movement of the lower bar through its connection with the crosshead on the operating piston rod, the normal relation of the upper and lower bar being thus restored.

The cab arrangement with this construction was awkward because of the length required for the moving bars and their guides. Without changing the functions of the gear, the double bar operating mechanism has been substituted by a

rack and pinion lapping device placed below the cab floor, while the graduating valve is directly operated by means of a rotary handle and circular toothed quadrant in the cab. This provides a cab equipment which is compact, and which is no more difficult to operate than the automatic brake valve.

By referring to the sectional view of the operating valve in the accompanying drawing it will be seen that the moving parts are two rotary disks. The main valve *P* on its upper face is seated against the valve chamber cap. The upper end of the hollow stem of this valve carries the toothed pinion *Q* and this meshes with the rack *J*, the connection of which with the crosshead of the operating piston is clearly shown in the drawing. The ports in the upper face of the main valve are so arranged that registration is maintained throughout a complete revolution. The lower,

This lug operates in a short recess in the upper face of the pinion and limits the extent to which the graduating valve may be moved ahead of the main valve. Under normal conditions, with air pressure available, the movement of the piston in the operating cylinder promptly follows that of the graduating valve and reverse lever, which may thus be moved quickly from any position in the quadrant to any other desired. Should an attempt be made to move the engine in the roundhouse before the pump is started, however, no movement of the piston will follow the operation of the reverse lever in the cab and this condition is immediately brought to the attention of the hostler or engineman by his inability to move the reverse lever beyond the comparatively narrow limits of the recess in the face of the pinion. The position of the reverse lever is thus an indication of the position of the link in the block whether pres-

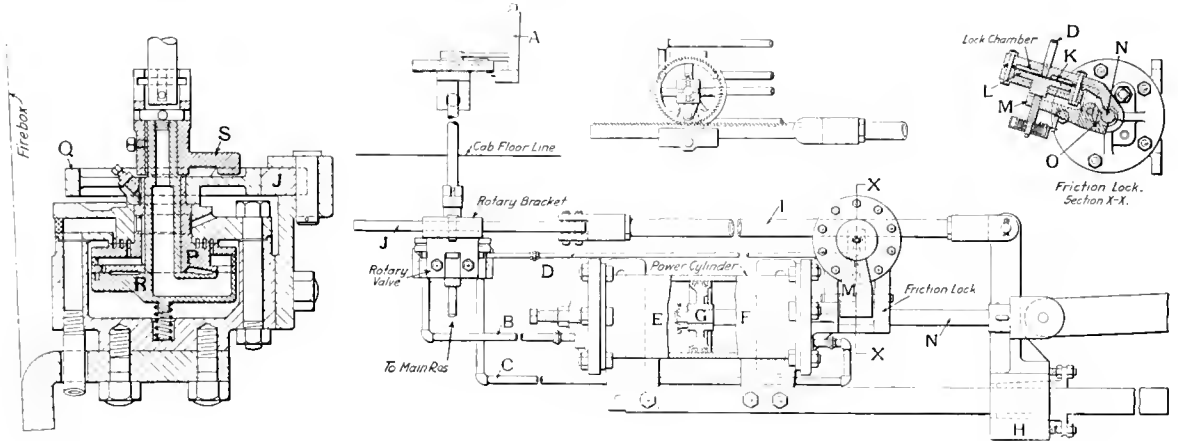

General Arrangement and Sectional Elevation of the Rotary Valve of the Snyder Power Reverse Gear

or graduating valve *K*, is seated against the lower face of the main valve. The graduating valve stem passes up through the hollow stem of the main valve and is attached at its upper end to the reverse lever *A* through an operating shaft and the coupling sleeve *S*.

The normal relation of the graduating valve and main valve is such that the ports leading to the two ends of the operating cylinder are both connected to the atmosphere, while the locking diaphragm is in direct communication with the source of pressure. Any movement of the reverse lever *A* and graduating valve immediately releases the pressure in the lock chamber to the atmosphere and admits pressure either to the rear or forward end of the operating cylinder, depending upon whether the reverse lever is moved forward or backward. The resulting movement of the operating piston causes a corresponding movement through the rack and pinion of the main valve which is thus caused to follow the movement of the graduating valve. The two valves assume their normal or neutral position relative to each other immediately after the movement of the reverse lever ceases, air pressure then being released from the operating cylinder to the atmosphere and admitted to the lock chamber.

It is evident that the position of the block in the link is determined solely by the position of the reverse lever and is unaffected by the condition of the operating piston rings and piston rod packing or by the condition of the valve itself. Leakage can only increase the air consumption during the short periods that the parts are actually in motion.

It will be noted that the connecting sleeve which joins the operating rod to the graduating valve stem, is provided with an arm on the end of which is a downward projecting lug.

sure is available to operate the gear or not and it is impossible to move the reverse lever from one position to another only to find after the engine has been started that the position of the link blocks has been changed.

The locking device on the new gear remains essentially the same as that which was previously described. Although designed primarily for operation with air pressure, this reverse gear may be arranged for operation with steam.

PORTABLE COLUMN BORING BAR

The illustration shows a small portable column boring bar which has recently been designed by the Pedrick Tool & Machine Company, Philadelphia, Pa. As shown, the column of the machine is mounted on a base for use on a floor plate, but for boring or drilling parallel holes in large pieces, the column may be mounted on a long bed, the axis of which is placed at right angle to the center line of the bar. In the design of this tool, effort has been directed toward securing the greatest possible simplicity. While this in a measure limits the range of its usefulness in comparison with larger and more expensive standard floor boring machines, it is the belief that under many conditions this is not of sufficient importance to overcome the advantages which simplicity affords.

The bar is driven through a train of powerful compound gearing by an electric motor which is mounted on brackets supported from the gear housing. Connection from the motor to the gearing train is made through a second system of gearing which is carried on a movable arm. The speed of the bar is changed by using different sizes of gears on this arm. The compound gears are also arranged to be

driven directly from the primary pinion shaft or through the intermediate gear shaft, a change of driving speed also being effected in this manner. The bar is provided with a new constant feed arrangement having three changes which are available for either direction of operation.

The design of the boring bar differs materially from the usual practice, the arrangement being such that the bar may be used either fixed or traveling and changed from one method of operation to the other almost instantly. As is the case with the standard portable boring bar manufactured by the same company, a square thread feed screw is contained in a groove in the bar of this machine. The screw is supported in bronze bearings of special design to take the thrust and a cutter head engaging the feed screw

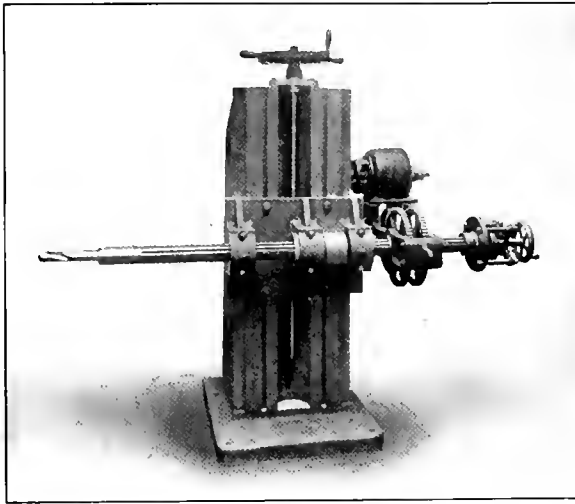

Portable Column Boring Bar of Simple Design

by a half-nut, travels along the bar. When used in this manner with the bar fixed, the outer end is supported by a column of conventional design with a movable bearing to facilitate the proper adjustment of the bar. When possible to use the tool in this manner, the advantages are clearly apparent as the bar does not have to be twice the length of the work, and the work is placed close to the main bearing where the bar is rigidly supported. With the bar fixed the capacity of the machine ranges from bores of 3½ in. to 24 in. diameter.

Conditions are often encountered which call for the use of a bar capable of boring long holes of small diameter. Heretofore it has been impossible with this type of bar, to bore holes through which the bar itself could not be passed, and as the smallest practicable diameter of bar is fixed by the necessity of providing a feed screw of reasonable strength, a considerable range of the smaller bores is thus unprovided for. In order that work of this kind may be handled, the bar has been designed to travel, just as would the spindle of a drill press or boring machine. In the end of the bar is a Morse taper socket for the insertion of drills or auxiliary bars. Where used for boring out small bearings an auxiliary bar with a fixed tool, properly supported at the outer end, may be used, the travel of the tool being effected by the travel of the main bar.

The bar has a vertical adjustment on the column ranging from 14½ in. to 56½ in. above the floor plate, thus providing a vertical travel of the saddle on the column of 42 in. The travel of the cutter head on the bar is 48 in. while the travel of the bar itself is 54 in. for the 3½ in. bar, these dimensions being respectively 52 in. and 45 in. for the 4 in. and 4½ in. bars. The net weight of the column

with base plate is 2,900 lb., while the machine complete, mounted on a bed, ranges from 4,200 to 4,500 lb., depending on the size of the bar. A motor of 1½ hp. rating is required for the 3½ in. bar; a 2 hp. motor is required for the two larger bars.

CRANK PIN INSPECTION GAGE

The government rules for the inspection of locomotives increase the cost of inspecting engines and require considerable time, particularly when the monthly inspection is made. To reduce the delay incident to the inspection of main and side rod bearings, P. J. Colligan, master mechanic of the Rock Island at Chicago, has devised an ingenious method, the main features of which are now protected by patent. Mr. Colligan's invention covers crank pin collars with holes cored or drilled opposite the edge of the pin, making it possible to insert a gage or feeler between the pin and the bushing to determine the amount of wear. A special gage is provided which has sections of the proper thickness for main rods or side rods of either road or yard engines. It is only necessary to select the proper feeler for the pin which is being inspected and insert it through the hole in the collar which shows the greatest opening. If the gage will pass between the brass and the pin, the limit of wear has been reached. This gage is shown in the illustration. As will be seen, it also provides a means of determining what the allowable limit has been reached on crossheads and one section serves as a staybolt gage.

This method of inspection possesses numerous advantages. It saves the time consumed in removing and replacing col-

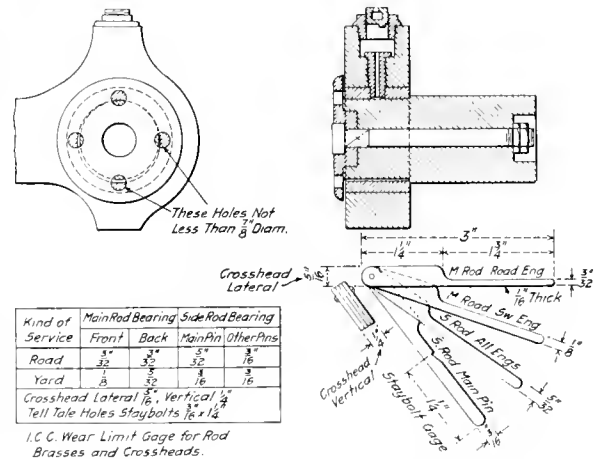

Colligan Crank Pin Collar and Inspection Gauge

lars and reduces the chances of collars becoming loose due to their being improperly re-applied. In some cases the wear of bushings is determined by raising the rod with a bar and measuring the amount of movement. This method is inaccurate, as oftentimes there is a considerable thickness of grease between the surfaces, or the rods are held rigidly by the crank pins. Neither of these factors interferes with the use of the gage devised by Mr. Colligan. The holes in the crankpin collars make it easy for the engineer to locate a "pound" in the rods and thus save unnecessary labor in the roundhouse. It can also be used to tell when a sufficient amount of grease has been fed to the bearings.

The expense of drilling holes in the collars is small and for new work or renewals the opening can be cored. This arrangement has been applied to a large number of engines. The Jerome-Edwards Metallic Packing Company, Chicago, is handling the sale of this device.

Railway Mechanical Engineer

(Formerly the RAILWAY AGE GAZETTE, MECHANICAL EDITION
with which the AMERICAN ENGINEER was incorporated)

PUBLISHED ON THE FIRST THURSDAY OF EVERY MONTH BY THE
SIMMONS-BOARDMAN PUBLISHING COMPANY

EDWARD A. SIMMONS, *President* L. B. SHERMAN, *Vice-President*
HENRY LEE, *Vice-President and Treasurer* M. H. WIDM, *Secretary*
WOODWORTH BUILDING, NEW YORK, N. Y.
F. H. THOMPSON, *Business Manager*, CHICAGO

Chicago: Transportation Bldg. Cleveland: Citizens' Bldg.
Washington: Home Life Bldg.
London: Queen Anne's Chambers, Westminster.

ROY V. WRIGHT, *Editor*
R. E. THAYER, *Managing Editor*
C. B. PECK, *Associate Editor* A. F. STUBBS, *Associate Editor*

Entered at the Post Office at New York, N. Y., as mail matter of the
second class.

Both houses of Congress have now passed the bill increasing the membership of the Interstate Commerce Commission, but with differences which will necessitate reference to a conference committee.

Three of the all-steel cars authorized some time ago by Congress for the mine-safety service of the Bureau of Mines have just been delivered, and will take the place of three of the old cars which have been in operation since 1910. These cars are to be located at Reno, Nev.; Raton, N. Mex., and Butte, Mont.

The Interstate Commerce Commission has begun the work of moving from its present quarters, scattered through four different buildings in Washington, to its new office building at Eighteenth street and Pennsylvania avenue, where all of its departments will have modern and commodious quarters under one roof.

The Executive Committee of the National Defense Committee of the American Railway Association has notified the railroads of the country that the Secretary of War has approved the suggestion of the committee that the holding of conventions which stimulate passenger travel be discouraged, at least until the railroads are more nearly able to handle the freight business that is being offered.

The Railway Fuel Company, with capital stock of \$10,000, has been organized at Birmingham, Ala., and has acquired coal lands to the extent of 2,000 acres or more, in Walker county, Alabama. The president and other officers of the company are officers of the Southern Railway Company, and it is said that the purpose is to furnish coal for use in the locomotives and in the shops of that railroad.

Charles Gates Dawes, president of the Central Trust Company, Chicago, has been recommended for the position of lieutenant-colonel in the seventh regiment of the railway contingent of nine regiments being organized by S. M. Felton, president of the Chicago Great Western. If his commission is approved, Mr. Dawes will be assigned to duty at Atlanta, Ga., where the seventh railway regiment is now being recruited.

The Interstate Commerce Commission has announced a postponement of the effective date of its locomotive headlight order issued last December. The commission's requirements as to headlights will apply to all locomotives constructed after October 1, 1917, instead of July 1, and for locomotives con-

structed prior to that date the changes required are to be made the first time they are shopped for general or heavy repairs after October 1, but all locomotives are to be equipped by July 1, 1920.

Subscriptions, including the eight daily editions of the *Railway Age Gazette* published in June in connection with the annual conventions of the Master Car Builders' and American Railway Master Mechanics' Associations, payable in advance and postage free: United States, Canada and Mexico, \$2.00 a year; Foreign Countries (excepting daily editions), \$3.00 a year; Single Copy, 25 cents.

WE GUARANTEE, that of this issue 9,100 copies were printed; that of these 9,100 copies 7,998 were mailed to regular paid subscribers, 118 were provided for counter and news companies' sales, 291 were mailed to advertisers, 189 were mailed to exchanges and correspondents, and 504 were provided for new subscriptions, samples, copies lost in the mail and office use; that the total copies printed this year to date were 63,747, an average of 9,106 copies a month.

The RAILWAY MECHANICAL ENGINEER is a member of the Associated Business Papers (A. B. P.) and the Audit Bureau of Circulations (A. B. C.).

In the discussion of the emergency shipping fleet section of the Deficiency Appropriation bill in the Senate on May 10, Senator Hoke Smith, of Georgia, proposed an amendment to the bill, which authorized the purchase of ships for carrying freight, appropriating \$100,000,000 for the purchase of freight cars. The amendment would reduce to that extent the appropriation for an emergency merchant fleet. The amendment provided that the cars shall be used by railroad companies under such terms and for such compensation as may be approved by the President.

The Southern Pacific recently compiled statistics showing comparative prices of railway materials in May, 1915, and May, 1917. Prices of locomotives have increased approximately 75 per cent, the price of the Pacific type, for instance, advancing from \$27,000 to \$47,290. Passenger cars have increased 50 per cent in cost, the price of a steel chair car in 1915 being \$12,500 as compared with \$18,750 in 1917. Various types of freight cars have increased from 60 to 85 per cent in price. Steel underframe box cars which cost \$1,255 in 1915 now command a price of \$2,010.

Senator Pomerene has introduced in Congress a joint resolution, S. J. Res. 77, to provide for the regulation of the production, sale and distribution of coal during the war. The resolution authorizes the President to fix the prices of coal, and to regulate the methods of sale, routes of transportation, and apportionment of coal among merchants and consumers, either directly or through the Federal Trade Commission, or such other agency as he may designate, for the period of the war or for such time as he may consider necessary. If a coal mine operator or dealer conducts his business in a manner prejudicial to the public interest, the President is authorized to take over the business.

Increased Pay for Shop Men

The Louisville & Nashville has made a general increase in the pay of shop men, said to affect 8,000 men; and for most of these men the workday has been reduced from nine hours to eight hours. The pay of machinists and boiler-makers has been increased from 42 cents an hour to 48 cents.

The Nashville, Chattanooga & St. Louis has increased the pay of shopmen on a basis substantially the same as that which has been announced by the Louisville & Nashville.

The Chicago, Milwaukee & St. Paul has granted to its machinists, to the number of about 2,000, an increase in pay of 8½ cents an hour, effective from May 1.

It is announced at Paducah, Ky., that the shopmen of the Illinois Central, and also those of the Vazoo & Mississippi Valley, have received an advance in pay amounting to 1½ cents an hour.

The Canadian Northern has increased the pay of shopmen throughout the company's lines. It is said that the rates on all divisions, from Lake Superior to the Pacific Coast, are now uniform, the increases west of Winnipeg being less than those east of that point.

The Canadian Pacific has advanced the pay of shopmen 6 cents an hour, the increase being granted to all employees belonging to the federated unions. According to a statement in a Montreal paper, several hundred women are included in this advance. This road increased the pay of trainmen last month.

MEETINGS AND CONVENTIONS

International Railroad Master Blacksmiths' Association.—At a meeting of the executive committee of the International Railroad Master Blacksmiths' Association held in Chicago on May 26, it was voted to postpone for one year the annual meeting of the association, which was to have been held in August at Chicago.

American Railway Tool Foremen's Association.—At a joint meeting of the officers and executive committees of the American Railway Tool Foremen's Association and the Supply Association held at the Hotel Sherman, Chicago, June 2, 1917, it was unanimously voted that the ninth annual convention of the association should be postponed for one year. The American Railway Tool Foremen's Association and the Supply Association jointly donated the sum of \$50 to the American Red Cross. The secretary-treasurer has been instructed to publish the 1917 Year Book as heretofore.

The following list gives names of secretaries, dates of next or regular meetings and places of meeting of mechanical associations:
AIR BRAKE ASSOCIATION.—F. M. Nellis, Room 3014, 165 Broadway, New York City.

AMERICAN RAILROAD MASTER TINNERS', COPPERSMITHS' AND PIPEFITTERS' ASSOCIATION.—O. E. Schlink, 485 W. Fifth St., Peru, Ind. Convention postponed.

AMERICAN RAILWAY MASTER MECHANICS' ASSOCIATION.—J. W. Taylor, Karpen Bldg., Chicago. Convention postponed.

AMERICAN RAILWAY TOOL FOREMEN'S ASSOCIATION.—R. D. Fletcher, Belt Railway, Chicago. Convention postponed.

AMERICAN SOCIETY FOR TESTING MATERIALS.—Prof. E. Marburg, University of Pennsylvania, Philadelphia, Pa.

AMERICAN SOCIETY OF MECHANICAL ENGINEERS.—Calvin W. Rice, 29 W. Thirty-ninth St., New York.

ASSOCIATION OF RAILWAY ELECTRICAL ENGINEERS.—Joseph A. Andreacetti, C. & N. W., Room 411, C. & N. W. Station, Chicago.

CAR FOREMEN'S ASSOCIATION OF CHICAGO.—Aaron Kline, 841 Lawlor Ave., Chicago. Second Monday in month, except June, July and August, Hotel La Salle, Chicago.

CHIEF INTERCHANGE CAR INSPECTORS' AND CAR FOREMEN'S ASSOCIATION.—W. R. McMunn, New York Central, Albany, N. Y. Convention postponed.

INTERNATIONAL RAILROAD MASTER BLACKSMITHS' ASSOCIATION.—A. L. Woodworth, C. H. & D., Lima, Ohio. Convention postponed.

INTERNATIONAL RAILWAY FUEL ASSOCIATION.—J. G. Crawford, 547 W. Jackson Blvd., Chicago.

INTERNATIONAL RAILWAY GENERAL FOREMEN'S ASSOCIATION.—William Hall, 1126 W. Broadway, Winona, Minn. Convention postponed.

MASTER BOILERMAKERS' ASSOCIATION.—Harry D. Vought, 95 Liberty St., New York. Convention postponed.

MASTER CAR BUILDERS' ASSOCIATION.—J. W. Taylor, Karpen Bldg., Chicago. Convention postponed.

MASTER CAR AND LOCOMOTIVE PAINTERS' ASSOCIATION OF U. S. AND CANADA.—A. P. Baber, B. & M., Reading, Mass. Convention, September 11, 1917, Hotel La Salle, Chicago.

NIAGARA FRONTIER CAR MEN'S ASSOCIATION.—E. N. Frankenberger, 623 Brisbane Bldg., Buffalo, N. Y. Meetings, third Wednesday in month, New York Telephone Bldg., Buffalo, N. Y.

RAILWAY STOREKEEPERS' ASSOCIATION.—J. P. Murphy, Box C, Collinwood, Ohio. Convention postponed.

TRAVELING ENGINEERS' ASSOCIATION.—W. O. Thompson, N. Y. C. R. R., Cleveland, Ohio.

PERSONAL MENTION

GENERAL

G. H. BISSING, superintendent of motive power and equipment of the Mexico Northwestern, has been promoted to general superintendent in charge of the transportation, maintenance of way and mechanical departments, with office at Ciudad Juarez, Chihuahua, Mexico. The position of superintendent of motive power and equipment has been abolished.

E. B. HALL, assistant to the general superintendent of motive power of the Chicago & North Western at Chicago, Ill., has been appointed acting assistant superintendent at Milwaukee, Wis., succeeding P. Campbell, granted leave of absence.

WILLIAM SCHLAFOL, general mechanical superintendent of the Erie, is now located at Meadville, Pa. The headquarters of both the mechanical and stores departments have been removed from New York to Meadville.

CARL SCHOLZ, manager of the mining and fuel department of the Chicago, Rock Island & Pacific at Chicago, has been appointed mining engineer of the Chicago, Burlington &



Carl Scholz

Quincy, with the same headquarters. Mr. Scholz was born at Slawentzitz, Germany, on July 2, 1872. He was educated in mining engineering at the Royal Gymnasium at Beuthen, Germany, and came to the United States in 1889. From 1891 to 1895, he was mining engineer for the Mount Carbon Company, Powellton, Va. From the latter date until 1901, he was part owner and manager of the Thomas Scholz Company, the

Superior Coal & Lumber Company, and the Railway Extension Company, of Mammoth, W. Va., the Riverside Coal Company, of Riverside, W. Va., and the Carbon & Coke Company, Carbon, W. Va. In August, 1902, he became connected with the mining department of the Chicago, Rock Island & Pacific, and later was manager of the mining and fuel department, at the same time being president of the Rock Island Coal Mining Company and the Coal Valley Mining Company and director of the Improved Combustion Company and of the Crawford County Mining Company. He has been president of the American Mining Congress for three terms, and in 1910 was sent to Europe by the United States Bureau of Mines to investigate and report on mining conditions. As mining engineer of the Burlington he will have charge of the development of the southern Illinois coal properties of that road.

MASTER MECHANICS AND ROAD FOREMEN OF ENGINES

A. E. DALES, heretofore division master mechanic of the Canadian Pacific at Edmonton, Alta., has been appointed division master mechanic at Calgary, Alta.

G. H. LIKERT, general foreman of the locomotive department of the Chicago, Rock Island & Pacific, at Horton,

Kans., has been appointed master mechanic of the Colorado and Nebraska divisions, with headquarters at Goodland, Kans., succeeding M. B. McPartland, resigned.

F. WILLIAMS has been appointed superintendent and master mechanic of the Gulf, Florida & Alabama, with headquarters at Pensacola, Fla. He succeeds J. P. Lynahan, superintendent, and B. Dotson, master mechanic, resigned.

W. H. WORIMAN, formerly division master mechanic of the Canadian Pacific at Calgary, Alta., has been appointed division master mechanic and trainmaster at Cranbrook, B. C., succeeding G. Moth.

CAR DEPARTMENT

P. S. WALTER has been appointed general car inspector of the Pennsylvania Lines West of Pittsburgh, Southwest system, with office at Columbus, Ohio, succeeding Charles F. Thiele, promoted.

SHOP AND ENGINEHOUSE

L. F. VON BLUCHER, roundhouse foreman of the Gulf, Colorado & Santa Fe at Galveston, Tex., has been recommended for first lieutenant in the Third Reserve Engineers.

S. HAYWARD, heretofore locomotive foreman of the Canadian Pacific at Swift Current, Sask., has been appointed locomotive foreman at North Bend, B. C., succeeding John MacRae, transferred.

JOHN MACRAE, formerly locomotive foreman of the Canadian Pacific at North Bend, B. C., has been appointed locomotive foreman at Swift Current, Sask., succeeding S. Hayward, transferred.

STEPHEN E. MUELLER, general foreman of the locomotive department of the Chicago, Rock Island and Pacific at Cedar Rapids, Ia., has been recommended for first lieutenant in the Third Reserve Engineers.

F. P. NASH, general foreman of shops of the Illinois Central at Palestine, Ill., has been recommended for a commission as first lieutenant in the Illinois Central company of the Chicago railway regiment, the Third Reserve Engineers.

E. P. POOLE, supervisor of tool equipment and piecework of the Baltimore & Ohio at Baltimore, Md., has been promoted to assistant superintendent of the Mt. Clare (Baltimore) shops.

J. S. TEMPLE has been appointed supervisor of tool equipment and piecework of the Baltimore & Ohio, with headquarters at Baltimore, Md., succeeding E. P. Poole, promoted. Mr. Temple has been for some time in the department, having supervision over tool equipment and piecework.

PURCHASING AND STOREKEEPING

BENJAMIN S. HINCKLEY, purchasing agent of the Boston & Maine at Boston, Mass., resigned on July 1 to go into other business. Mr. Hinckley has been in railroad service since August 1, 1899, and has been purchasing agent of the Boston & Maine since July, 1911.

W. J. HINER, assistant purchasing agent of the Cleveland, Cincinnati, Chicago & St. Louis, has been appointed purchasing agent at Cincinnati, Ohio, succeeding George Tozzer, retired.

A. W. MUNSTER, general storekeeper of the Boston & Maine, at Boston, Mass., has been appointed purchasing agent, succeeding B. S. Hinckley, resigned.

COMMISSION APPOINTMENT

CHARLES A. NELSON, heretofore with the Delaware & Hudson Company, has been appointed junior railway mechanical engineer in the division of valuation of the Interstate Commerce Commission, Eastern district, with office at Washington, D. C.

SUPPLY TRADE NOTES

Jack Coughlin, treasurer of the Railway Motor Company of America, died at his home in Chicago on June 7.

The Mahr Manufacturing Company, Minneapolis, Minn., has opened an office at 120 Liberty street, New York, in charge of J. R. Matthews.

The New York offices of the General Electric Company were moved on June 16 from 30 Church street to the Equitable building, 120 Broadway. The entire twentieth floor of the building will be occupied by the company.

The Barco Brass & Joint Company, Chicago, announces that on July 1 the name of the company was changed to Barco Manufacturing Company.

W. P. Steele has been appointed western representative of the American Locomotive Company, with headquarters in the McCormick building, Chicago.

James H. Slawson, sales agent of the National Malleable Castings Company at Chicago, has been elected vice-president of the Joliet Railway Supply Company, with headquarters



J. H. Slawson

at Chicago. Mr. Slawson was born at Cleveland, Ohio, and entered railway service in 1890 with the Lake Shore & Michigan Southern in the same city. He was successively employed in the office of the assistant general freight agent, in the revision department, the tariff bureau, the auditing department and the office of the chief engineer. In 1902 he was employed by the National Malleable Castings Company at the Sharon (Pa.) plant with special railroad

duties. He was later made chief clerk, following which he was promoted to local treasurer in charge of the business affairs of the Sharon plant, and in 1912 was transferred to Chicago as sales agent. The Joliet Railway Supply Company, of which he becomes vice-president, is a subsidiary of the Northwestern Malleable Iron Company of Milwaukee, Wis.

The Illinois Steel Company, Chicago, announces the appointment of C. H. Rhodes, of the Canadian Steel Company, as purchasing agent, succeeding J. C. Hoot.

J. A. Meaden, vice-president of Paul Dickinson, Inc., Chicago, has resigned to become sales manager of the Automatic Screw Machine Products Company, Chicago.

Brown & Company, Inc., Pittsburgh, Pa., makers of fine irons and steels, has changed the location of its New York office from 50 Church street to Room 2038, Grand Central Terminal.

W. L. Garland, sales representative of the Safety Car Heating & Lighting Company at Philadelphia, Pa., has also been appointed representative of the Vapor Car Heating Company, Inc.

The Steel Car Company, Cleveland, Ohio, has placed a new plant in operation for the repair of wooden cars. The

company is planning to put up another building for the repair of steel cars.

W. W. Hall, formerly Pittsburgh sales manager of the Republic Iron & Steel Company, has been appointed assistant general manager of the Columbia Steel & Shafting Company, Pittsburgh, Pa.

H. F. Bigler, Jr., has been transferred to the railway department of the A. M. Byers Company, Pittsburgh, Pa., and from now on will devote all of his time to railway work, assisting S. P. Broome.

Karl W. Bock, formerly secretary and assistant to the vice-president of the Union Pacific Coal Company, Omaha, Neb., has been appointed manager of the Walter A. Zelnicker Supply Company, St. Louis, Mo.

The Lincoln Electric Company, Cleveland, Ohio, announces that it has appointed as its Indianapolis representative the Ross Power Equipment Company, 617 Merchants' Bank building, Indianapolis, Ind.

J. W. Bettendorf, president and treasurer and J. H. Bendixen, second vice-president and sales manager of the Bettendorf Company, will assume the duties of Robert Parks, who has resigned as general manager.

H. G. Doran & Co., Peoples Gas building, Chicago, has been incorporated to buy and sell mechanical and other devices, with a capitalization of \$10,000. Harry G. Doran is president and A. D. Cloud, secretary.

The H. W. Johns-Manville Company has moved its Pittsburgh showrooms to new and larger quarters, and sales offices were opened on the ground floor of the Westinghouse building, corner of Ninth street and Pennsylvania avenue.

Charles H. McCormick, for a number of years connected with the Standard Heat & Ventilation Company, has been appointed special sales agent for the National Railway Appliance Company, at 50 East Forty-second street, New York.

Walter H. Bentley, vice-president of Mudge & Co., Chicago, has been elected president of the Locomotive Specialty Company, Railway Exchange building, Chicago, general distributors of the Ripken main rod arm and other railway specialties.

The Ryan Car Company has started to employ women workers in its works at Hegewisch, Ill., in order to overcome the shortage of labor. On June 25 five women were put to work doing light manual labor such as handling lumber, sorting light material, etc.

Robert Parks, general manager of the Bettendorf Company, Bettendorf, Iowa, has resigned to become connected with the Canadian Car & Foundry Company. It is reported that the Canadian Car & Foundry Company will open their Ft. William (Ont.) plant shortly.

The Dakin Emergency Safety Brake Company, Indianapolis, Ind., has been incorporated with a capital stock of \$50,000, to manufacture safety brakes and other devices. G. E. Dakin, M. A. Dakin and Samuel Dakin, all of Stanton, Mich., are directors of the corporation.

The American Steel Export Company, New York, announces the appointment of Charles S. Vought as assistant general manager of sales. Mr. Vought was formerly one of the managers of the order department of the Cambria Steel Company, and has been associated with the American Steel Export Company for some time.

Ralph E. Graves, Pittsburgh representative of the Cleveland Punch & Shear Works Company, Cleveland, Ohio, has been placed in charge of the new office opened by that concern in the McCormick building, Chicago, and will have charge of the middle western territory. T. J. McNamara succeeds Mr. Graves as manager of the Pittsburgh office.

Locomotive Stoker Company

The Locomotive Stoker Company announces the appointments of W. G. Clark as general sales manager, with headquarters at Pittsburgh; F. L. Wassell as Western sales manager, with headquarters

in the Railway Exchange building, Chicago, and O. B. Capps as eastern sales manager, with headquarters at 50 Church street, New York.

W. G. Clark, prior to his appointment as general sales manager, held the position of western manager of the company. He graduated from Columbia University in 1899 and at once entered the mechanical engineering department of the Metropolitan Street

Railway Company in New York. In 1902, he became connected with the Westinghouse interests by entering the engineering department of the Westinghouse Electric & Manufacturing Company at East Pittsburgh. He then went to the Westinghouse Air Brake Company as inspector, and later was representative at St. Louis, Mo. In 1905, he was appointed western manager of Westinghouse, Church Kerr & Co., which position he left to become western manager of the Locomotive Stoker Company, with headquarters at Chicago.

F. L. Wassell, who has been appointed western sales manager, was formerly secretary of the company. Mr. Wassell became associated with the Westinghouse interests in 1910, when he entered the employ of the Westinghouse Air Brake Company at Wilmerding, Pa., as private secretary. He later became assistant secretary of this company. In 1913 he was made secretary of the Locomotive Stoker Company, but it was not until the summer of 1916 that he became actively connected with the Stoker company as its secretary at Pittsburgh.

O. B. Capps, who has been appointed to the position of eastern sales manager, was formerly eastern representative. Mr. Capps started work in the mechanical engineering department of the American Locomotive Company at Schenectady, N. Y.



W. G. Clark



F. L. Wassell



O. B. Capps

In 1909, he left the Locomotive company to enter the employ of the Locomotive Stoker Company as mechanical expert at Schenectady. In the summer of 1915, he took up the sales work as eastern representative, with headquarters at 50 Church street, New York City, which position he now leaves to become eastern sales manager, as above noted.

C. A. Newman, formerly manager of sales promotion for Henion & Hubbell, Chicago, wholesalers in power pumps, mining and mill supplies, has been made sales manager of the Boiler-Kote Company, with general sales offices in the Fisher building, Chicago.

The Walter A. Zelnicker Supply Company, St. Louis, and allied companies have secured the services of Charles H. Trapp, who is to act as confidential secretary to Mr. Zelnicker, the president. Mr. Trapp was associated with James Stewart & Co. in St. Louis, Denver and Idaho, and lately with Terrell Croft, consulting electrical engineer, St. Louis.

Carl B. Woodworth, general foreman of the Mt. Clare shops of the Baltimore & Ohio, has been appointed a member of the staff of traveling engineers of the American Arch Company. Mr. Woodworth was born in Fort Wayne, Ind., on December 16, 1883. He was educated in the public schools and served a machinist apprenticeship in the Wabash shops in that city. In 1907 he graduated from the mechanical engineering course of Purdue University and then entered the service of the Baltimore & Ohio at Garrett, Ind., as machinist. Subsequently he was appointed roundhouse foreman at Parkersburg, W. Va., motive power inspector at Loraine, Ohio, and acting master mechanic at Benwood, W. Va. He has also served as chief inspector at the Baldwin Locomotive Works and supervisor of shop practice at the Mt. Clare shops.

New Officers of the Westinghouse Electric & Manufacturing Company

At the meeting of the board of directors of the Westinghouse Electric & Manufacturing Company, held at New York on June 20, the board, in addition to declaring a regular quarterly dividend of 1 $\frac{3}{4}$ per cent on both preferred and common stock, also declared an extra dividend of $\frac{1}{2}$ of 1 per cent on both common and preferred stock, amounting to \$375,000, for the benefit of the Red Cross.

The following officers were elected: Guy E. Tripp, chairman of the board; E. M. Herr, president; L. A. Osborne, Charles A. Terry, H. P. Davis, H. D. Shute, H. T. Herr, and Walter Cary, vice-presidents; T. P. Gaylord, acting vice-president; James C. Bennett, controller and secretary; Warren H. Jones, assistant secretary; H. F. Baetz, treasurer and assistant secretary; S. H. Anderson, assistant treasurer and assistant secretary; L. W. Lyons, assistant treasurer; F. E. Craig, auditor; W. B. Covil, Jr., and W. J. Patterson, assistant auditors.

Henry D. Shute, who has been promoted from treasurer to vice-president of the Westinghouse Electric & Manufacturing Company, has been associated with the company since 1893. Mr. Shute was born in Somerville, Mass. He graduated in electrical engi-

neering at the Massachusetts Institute of Technology in 1892. He later spent some time studying in Germany at the School of Mines in Clausthal, and also at the Technical School in Dresden. Mr. Shute has had a wide experience in the Westinghouse company. His first two years were spent in the testing department, and later he was engaged on erection and laboratory work. He subsequently became associated with L. B. Stillwell. For a short time afterwards he was an assistant foreman of the experimental department of the Niagara Falls Power Works. Later he was transferred to the engineering department, where he designed alternating current apparatus, being prominently identified with the steam railroad electrification work

done by the Westinghouse company. After five years' service with the company, Mr. Shute took up work in the sales department, in which he remained until 1908 when he was made assistant to the vice-president, L. A. Osborne, which position he filled until 1910, when he was elected acting vice-president. In 1914, Mr. Shute was made treasurer of the company, succeeding T. W. Siemon.

Herbert Thacker Herr, who has been elected a vice-president of the Westinghouse Electric & Manufacturing Company, has been identified with the Westinghouse Machine Company since 1908, filling, respectively, the positions of general manager, second vice-president and general manager, and, finally, vice-president and general manager and a director of the company. Mr. Herr was born in Denver, Colo., and received his education in the public schools of Denver and at Yale University. After leaving college he became identified with the following railroads, in various capacities: Chicago & North Western, Denver & Rio Grande, Chicago, Great Western, Atchison, Topeka & Santa Fe, and the Norfolk & Western. In 1906 Mr. Herr was made general superintendent of the Denver & Rio Grande, and two years later retired from the railway field to become vice-president and general manager of the Duquesne Mining & Reduction Company, at Duquesne, Ariz., where he remained until he moved to Pittsburgh. Mr. Herr is officially connected with a number of other industrial and financial institutions, being a director of the Pittsburgh Meter Company, vice-president and director of the Westinghouse Air Spring Company, the Westinghouse Gear & Dynamometer Company, and the Rodman Chemical Company.

Walter Cary, who has been elected a vice-president of the Westinghouse Electric & Manufacturing Company, was since



H. T. Herr



H. D. Shute



Walter Cary

1904 associated with the Westinghouse Lamp Company, filling for the greater part of the time the positions of vice-president and general manager. Mr. Cary was born in Milwaukee, Wis., and received his education in the schools of that city, and at Harvard University. After leaving college he became associated with the Gibbs Electric Company, of Milwaukee, as secretary, and in 1889 he, with some other local men, formed the Milwaukee Electric Company, manufacturers of dynamos and motors, becoming its vice-president and in 1902 its president. Mr. Cary is well known throughout the electrical industry on account of his activities in the field of incandescent lighting.

H. F. Baetz, who has been elected treasurer of the Westinghouse Electric & Manufacturing Company, was born and raised in Pittsburgh, and educated in the schools of that city, graduating from Allegheny High School in the class of 1887. On the date of his election as treasurer, Mr. Baetz had just completed to a day 30 years of service with the Westinghouse Electric & Manufacturing Company. Mr. Baetz began his business career as a timekeeper in the Garrison plant of the Westinghouse Electric & Manufacturing Company, and after only one year of service, and at the age of 18, he was made paymaster of the company. Two years later he was transferred to the accounting department, where he worked until 1899, when he was made acting assistant treasurer. In 1902 Mr. Baetz was elected assistant treasurer of the company.

Tuco Products Corporation

The Tuco Products Corporation has recently been organized under the laws of New York, with a capital of \$500,000, and has purchased the entire business of the Transportation Utilities Company, of New York, and the Magnesite Products Company, of San Francisco. The former company has been engaged in business with the railroads for more than ten years, handling the "Tuco" brand of insulation and preservation; National car roofing; National and Universal trap doors; Imperial and Universal car screens; Eclipse deck sash ratchets; Perfection sash balances, and Kicker and Wedge locks for trap doors; Flexolith composition flooring; Resisto insulation; Tucolith plastic car flooring; Tucork insulation; Brown weatherstrips; the North Pole drinking fountain; pulverized magnesite and chloride magnesium. The Magnesite Products Company has been established for several years, manufacturing "Klingstone" flooring, magnesite, stucco, plaster and paint.



H. F. Baetz

Magnesite is one of the principal materials used in the manufacture of Tucolith plaster car floorings, and the only known suitable supply (low in lime content) heretofore came from the Balkan states. That source being shut off by the war, forced the company to make a search for the right raw material, and after exhaustive laboratory tests and resulting negotiations, the consolidation mentioned was effected, which assures a convenient and apparently unlimited supply. It also makes possible an expansion of the business, by which it is planned to deal with the application of stucco to old wooden passenger stations. There will also be added a complete line of fire-proof wall board, plaster and paints. Arrangements have practically been made for 16 branch agencies to handle the business in different sections of the United States and Canada.

David H. McConnell has been elected chairman of the board. Mr. McConnell has been identified with many large business interests in which his financial genius and business foresight have been a factor in their success. He is at the present time at the head of a large manufacturing business which employs thousands of agents, and is also a director in a number of railway supply companies.

David W. Pye, president of the corporation, is well known in the railway supply field. For 21 years he was connected with the Safety Car Heating & Lighting Company, which company he joined on September 1, 1889, as assistant to the treasurer. Later he was made purchasing agent, and still later made assistant to the president, then second vice-president, and finally vice-president. In 1910 he left that company to become president of the United States Light & Heating Company, and two years later was elected president of the Transportation Utilities Company. Mr. Pye has spent his entire business career of 27 years with large concerns specializing on railway requirements.

Garrett Burgert, vice-president and treasurer, was for 27 years with the Ramapo Iron Works, for the first 10 years as superintendent, and the remaining 17 years as sales manager. He was then elected president of the Metal Plated Car & Lumber Company, in which capacity he served for eight years, or until 1912, when that company was absorbed by the Transportation Utilities Company. He was then made secretary, and in 1916 was elected vice-president.

Harold B. Chamberlain will have direct charge of the railroad sales department. After Mr. Chamberlain left college he spent several years in the mechanical and car departments of the Baltimore & Ohio. He left railway service to accept an appointment in the mechanical department of the Safety Car Heating & Lighting Company. Later he went with the Transportation Utilities Company, and after several months in the plant was assigned to the selling staff.

W. V. V. Clarke has been appointed engineer of plants. Mr. Clarke, a Cornell graduate, has been especially educated in engineering and chemistry. He has for the last few years had charge of certain gas interests in Brooklyn, and will have direct charge of the San Francisco, Chicago and New York plants.



D. W. Pye

Thomas Berry, one of the founders of the firm of Berry Brothers, varnish manufacturers, Detroit, Mich., died at his home in that city on May 24. Mr. Berry was born in Sussex, England on February 7, 1829, and came to Detroit in 1856 with his two brothers, with whom he established the firm which bears his name, in 1858. He maintained an active interest in the business until shortly before his death.

L. H. Mesker, formerly sales manager of the Kearney & Trecker Company of Milwaukee, Wis., is now associated with the sales department of the Cleveland Milling Machine Company of Cleveland, Ohio. Mr. Mesker has had wide experience in machine tool sales having been connected with the Mott-Merryweather Company of Cleveland, and Manning, Maxwell & Moore, at St. Louis, Mo., and Cleveland.

CATALOGUES

OFFSET BORING HEAD.—Catalogue F, issued by the Marvin & Casler Company, Canastota, N. Y., describes and illustrates the Casler offset boring head.

TOOLS.—Tool book No. 13, recently issued by the Goodell-Pratt Company, Greenfield, Mass., is a 432-page booklet descriptive of the company's line of tools of all kinds.

HEATING APPLIANCES.—A booklet issued by the Gold Car Heating & Lighting Company, New York, describes that company's thermostatic heat regulating system for public buildings, etc.

PUSH BUTTON SPECIALTIES for small power and light wiring and remote control switches for industrial motors are described in catalogue No. 8, issued by the Cutler-Hammer Manufacturing Company, Milwaukee, Wis.

SANITARY FIXTURES FOR RAILWAY CARS.—Catalogue No. 213, recently issued by the Dayton Manufacturing Company, Dayton, Ohio, is descriptive of the line of Dayton closets, washstands, water coolers, etc., for railway passenger cars.

METAL HOSE.—A booklet recently issued by the Pennsylvania Flexible Metallic Tubing Company, Philadelphia, illustrates and describes the company's Penflex metal hose. Several pages of the book are devoted to the use of the hose by railways.

OXY-ILLUMINATING GAS APPARATUS.—Bulletin 101, issued by the Bradford-Ackermann Corporation, New York, is a four-page folder illustrating and describing the "Astra" oxy-illuminating low pressure gas apparatus designed for lead burning purposes.

VISES AND ANVILS.—The Columbian Hardware Company, Cleveland, Ohio, has issued a catalogue showing its line of vises and anvils. The booklet in its 36 pages contains illustrations of the vises, remarks as to the uses for which they are intended, and lists of sizes and prices.

RIVET CUTTING GUN.—The Rivet Cutting Gun Company, Cincinnati, Ohio, has issued a catalogue describing its so-called rivet cutting gun, a pneumatic tool for cutting rivets. The booklet contains a number of illustrations of the gun in use in cutting rivets on freight cars, etc.

DIRECT CURRENT MOTORS from 1½ hp. to 40 hp. are described and listed in Bulletin No. 1000 of the Eck Dynamo & Motor Company, Belleville, N. J. The motors included are known as type D, have commutating poles, are ventilated by internal fans and are equipped with self-aligning ball bearings.

BALL BEARINGS IN MACHINE TOOLS.—This is the title of a very attractive booklet which has been issued by the Hess-Bright Manufacturing Company, Philadelphia. The booklet describes the annular type of ball bearing, and shows its advantages over earlier types. There are several illustrations of the bearings and machines on which they are used.

BOILER METAL TREATMENT.—The Perolin Railway Service Company, St. Louis, Mo., has recently issued an eight-page pamphlet outlining the service it renders in connection with the treatment of locomotive boilers with Perolin. The pamphlet describes the action of Perolin in removing scale from locomotive boilers and protecting the metal after the scale has been removed.

FLUE WELDING APPARATUS.—The Draper Manufacturing Company, Port Huron, Mich., has issued a booklet descriptive of its pneumatic flue welder for scarfing, welding and

swedging boiler tubes, its pneumatic tube welding machines for welding and swedging locomotive superheater tubes, its flue reclaiming attachments, and its ball finishing tools for repairing superheater units.

TOOL GRINDER.—Catalogue K-4, recently issued by the Gisholt Machine Company, Madison, Wis., describes and illustrates the Gisholt universal tool grinder. The booklet shows the advantages obtained by using the grinder and by keeping tool-post tools in a conveniently located tool room. Several of its pages show how tools are ground by the Gisholt method and a description is given of the grinders themselves.

FREIGHT CAR APPLIANCES.—Catalogues Nos. 10, 20 and 30, issued by the Wine Railway Appliance Company, Toledo, Ohio, deal respectively with that company's steel ladders, car ventilating shutters and the Wine self-centering roller side bearing. Each booklet is well illustrated with views of the appliances, plans showing their installation and views of cars on which they have been applied.

COMMONWEALTH DEVICES.—The open hearth cast steel devices manufactured by the Commonwealth Steel Company, St. Louis, Mo., are described in a pamphlet which the company has recently issued. The booklet illustrates and describes the trucks, underframes, bolsters, draft gear, etc., which the company manufactures. Scattered throughout the booklet are illustrations showing scenes at the company's plants and processes in the manufacture of steel castings.

THE BEST WAY OUT.—The Cleveland Twist Drill Company recently put on the market its Ezy-out screw extractors for removing broken set or cap screws, studs, staybolts, etc. The extractors have met with such success that the company has now also put on the market three other sets, in addition to the No. 17 set which was sold originally. These four sets, including 12 sizes of extractors, are described in a folder "The Best Way Out," recently issued by the company.

RIVETING MACHINES.—The John F. Allen Company, 372 Gerard avenue, New York, has recently issued a very complete catalogue showing its portable pneumatic compression and hammer riveting machines. The machines described in the catalogue consist of jaw riveters with 8, 10 and 12 in. cylinders, varying in weight from 775 lb. to 5,200 lb., compression lever riveters, lattice column riveters, alligator riveters, hammer riveters and belt-driven jaw riveter. A complete list of the different parts of these riveting machines is also included in the catalogue.

WOOD BLOCK FLOORS.—The Ayer & Lord Tie Company, Chicago, has issued a 24 page booklet illustrating and describing its interior wood block floors. This book describes the history of wood blocks for floors and pavements; their advantages for interior use from the standpoint of sanitation, comfort, cleanliness and general efficiency; and contains an exposition of the material and workmanship necessary for good results and a list of industrial and commercial structures for which these floors are applicable. The booklet is well illustrated by photographs.

PIPE THREADING AND CUTTING MACHINES.—The Landis Machine Company, Inc., Waynesboro, Pa., has recently issued Catalogue No. 23 illustrating its pipe and nipple threading machines, pipe threading and cutting machines and chaser grinder. This catalogue contains 45 pages, giving detailed descriptions of these machines together with the size and manner in which they should be ordered. A complete description of the Landis chaser is given and instructions for the application of them to the Landis holder. The descriptions of the pipe threading and cutting machines are given with specifications for the different types, including those with the mechanical speed change and those operated by the variable speed motor. Similar information is given regarding the pipe and nipple machines.

Railway Mechanical Engineer

Volume 91

August, 1917

No. 8

CONTENTS

EDITORIALS:

Everyone Can Help Win the War.....	421
Mechanical Association Year Books.....	421
Transporting Material in Shops.....	422
Better Operation of Locomotives.....	422
Car Men and the Car Shortage.....	422
Fuel Department Organization.....	422
Need for the Utilization of Scrap.....	423
Keeping the Valuation Up-to-Date.....	423
False Economy in Locomotive Repairs.....	423

COMMUNICATIONS:

A Foreman's Plea.....	424
Tobesura Weno "Back on the Job".....	424
Tools for the Workmen.....	424

GENERAL:

Modern British Tank Locomotives.....	425
Car and Locomotive Prices.....	430
D. & R. G. Santa Fe Type Locomotives.....	431
Rock Island Fuel Department.....	434
Method of Increasing Air Capacity on Double Headed Trains.....	435

CAR DEPARTMENT:

Strengthening Wooden Furniture Cars.....	437
Brake Cylinder Pressure Regulator.....	438
French Box Cars Built in America.....	439
Draft Arm of Rolled Steel.....	442
Safe Life of Air Brake Hose.....	443
Side Bearing Location.....	445
Mechanics of the Chilled Iron Wheel.....	446
Cut Journal—Owner's Defect.....	447
Safety Hanger for Brake Rigging.....	448

SHOP PRACTICE:

Handling Rods at Macren Shops.....	449
Hand Tools and Safety First.....	450
Conserve Material.....	451
Automatic Oil Filter.....	451
A Handy Staybolt Chuck.....	452
Machining Car Wheels and Axles.....	453
Exploded Reamer.....	454
Pneumatic Shearing Machine.....	455
Cutting Holes in Side Rods with Oxy-Acetylene.....	455
And Then the Worm Turned.....	456
Repairing Main and Side Rods.....	457
Jig for Reboring Compound Air Compressor Cylinders.....	458
Ball Bearing Pipe Center.....	459
Flat Punch for Ajax Bolt Machine.....	459
Alligator Power Shears.....	460
Norton Jack Truck.....	460

NEW DEVICES:

Apron for Heavy Duty Lathes.....	461
Vestibule Trap Door Lock.....	461
New Ajax Forging Machine.....	462
Water Gage Glass Guard.....	462
Thread Lead Indicator.....	463
Jig for Use in Upsetting Axles and Drawbars.....	463
Insulation for Passenger Car Floors.....	464
Special Tip for Cutting Rivet Heads by the Oxy-Acetylene Process.....	464
Kerosene Engine for McKeen Motor Cars.....	465

GENERAL NEWS:

Notes.....	466
Meetings and Conventions.....	467
Personal Mention.....	468
New Shops.....	469
Supply Trade Notes.....	470
Catalogues.....	472

Everyone Can Help Win the War

In spite of the greatly increased traffic which the railroads have had to handle in recent months, the car shortage is not nearly so severe as it was, although it is many times greater than it ever has been at this time of the year. Undoubtedly traffic conditions will be far more severe in the coming months because of the large amount of material that will have to be handled in connection with the encampments for the men who are now being conscripted, and the large amount of material that will have to be shipped abroad to our army in France and to our allies. Our success in the war is dependent in a very large degree upon the successful operation of our transportation systems and nothing should be left undone to maintain the equipment in the best of condition and prepare during the coming months for the unfavorable weather conditions which will have to be overcome during the winter. The remarkable success that the railroads have already had is largely due to the loyalty and patriotic spirit of the officers and employees and the general co-operation which has been extended to the railroads on the part of the public and the government in helping to secure better car loading. Railway employees must not neglect to do their full duty in seeing that the best possible service is secured from the equipment and that it is maintained in such condition that it will be able successfully to stand the heavy service to which it will be subjected not only during the coming winter but during the duration of the war—and

this promises to be not a matter of months but possibly of years. In a large measure the war has resolved itself into a business proposition and those who can contribute toward the better upkeep and operation of the railroads' transportation systems and the various industries are as important in the interest of a successful outcome as the men who will have to shoulder guns and fight in the trenches.

Mechanical Association Year Books

Practically every one of the railway mechanical associations have voted to postpone indefinitely their 1917 conventions. This was done because it was felt that the men could not be spared from their work. It is, of course, to be regretted that there will be no opportunity for the practical men to get together and discuss problems which are of so great importance at the present time. This can in a large measure, however, be obviated if every association will proceed as is its custom to publish a year book or official proceedings, including the papers that would have been presented at the convention. The General Foremen's Association has planned to publish its advance copies, in accordance with its past practice, and send them to the various members of the association with the request that each member study the papers carefully and send to the secretary written discussions concerning them. This plan could well be followed by other associations. After a definite date for the closing of the discussions, sufficient ma-

terial should be in the hands of the secretary to warrant the publication of the regular official proceedings. In this way the members of the association will have an opportunity of obtaining the ideas of others on important problems.

Every member of the associations which intend to follow this practice, should consider it his patriotic and individual duty carefully to study the various subjects and send to the secretary his best thoughts and information regarding them.

Transporting Material in Shops

The scarcity of labor makes it necessary to study closely the merits of any device that may be introduced into railroad shops with a view to conserving time and human energy. During the past few years a number of railroads have used electrically operated trucks for transporting material in and about shops with great success. The ease and rapidity with which these can cover the ground and negotiate sharp curves and the saving which they make possible in the number of laborers required about the shop are of extreme importance at this time. If necessary, a boy can operate them; in one railway storehouse in Canada a woman was observed in charge of one of these trucks. In a great many instances, and particularly in storehouses, trucks so arranged that the bodies can be elevated can be used to great advantage with special platforms. Material can be piled on these platforms and the body of the truck can be run under them, the platforms elevated and transported to another part of the shop, leaving the truck free to be used for other purposes while the platforms are being loaded and unloaded.

Better Operation of Locomotives

Never has such a heavy and prolonged stress been placed on the locomotives of this country, and the end of this abnormal situation is not in sight. It will last at least until the end of the war, and it is becoming more and more recognized that this may be a matter of years. The power must not be allowed to fail no matter how great this stress may become or how severe the coming winter may be; and it is vital also that the fuel which is used be conserved to as great an extent as possible. Every officer and employee in the operating and mechanical departments can do his share in helping to operate with the greatest possible economy and efficiency; but a specially heavy responsibility rests upon the shoulders of officers such as traveling engineers, road foremen of engines, traveling firemen, and those having similar duties. The men on the locomotive must be fully educated in the proper performance of their duties and as to the extreme importance of the transportation systems in winning the war. This can best be accomplished by personal contact and by showing the men in detail exactly how they can better their performance. The weakest spots in the force should be tackled first and simple methods must be adopted to let the men realize that their good and their bad points are recognized. Good performance should be commended and poor performance patiently studied so that the best means may be found to improve it. The traveling supervisors of locomotive operation and the engineers and firemen should also realize that the easiest way of overcoming trouble is by preventing it. A little energy exerted when defects first appear will often prevent heavy expense and holding the engine out of service later. Co-operate also with the engine house foreman and help him; do not criticise and approach him in a fault-finding spirit. His job is no easy one at any time and, particularly at the present time, it is no bed of roses. With more work and responsibility than he has ever had before, he is confronted with all sorts of labor and material troubles. Stand back of him with your help and influence; do not

heckle or hamper him. In so doing you will be rendering a real patriotic service to your fellows and your country.

Car Men and the Car Shortage

The Railway War Board a few months ago issued a strong appeal to the railroads to reduce the car shortage by loading cars to their capacity and by keeping to a minimum the number of cars undergoing repairs in shops. This appeal has been admirably answered and despite the abnormal business the railroads have been making a better showing. The work of the car foremen and car inspectors will have a direct bearing on how successfully the railroads meet the nation's needs. They are the men on the firing line who must challenge the enemy "defect." As the United States has joined the Allies in Europe and offered of her resources that the war might be won, so must the car repair forces ally themselves to the general cause of more cars and safe cars and "give to foreign cars, while on its line, the same care * * * * that it gives to its own cars." Never before did M. C. B. Rule 1 mean as much as it means today. There are no "home cars." There are no "foreign cars." There are "our country's cars."

On June 1 the net car shortage was 105,000 and although this was a decrease of 30 per cent under the shortage on May 1, it was 1,300 per cent greater than the largest previous shortage reported for the same month. The demands for equipment are unprecedented and with the heavy burden of military traffic in the late summer and fall the demands will be greater. The backbone of the railroads is equipment. The cars must be safe to operate; they must be strong enough to carry their full burden and there must be enough of them. The men in the trenches on the battlefield are offering their lives for their country. The men in the trenches of the railroad field can show their patriotism and valor by sticking to their jobs and putting the best they have into making the equipment serve its purpose, do its duty and carry supplies to those who are giving their lives.

Fuel Department Organization

Elsewhere in this issue is published a description of the fuel department organization of the Rock Island which is of particular interest in that the officers of the department rank as general officers and the department has full control of the purchase, inspection, distribution, handling and consumption of the fuel. It brings all fuel matters under one central head, that head having sufficient power to insure the different problems that arise in fuel matters being solved to the best interests of the railroad. Generally speaking, fuel has been considered largely a mechanical department matter. It is a fact that the mechanical department is responsible for the consumption of the fuel; it is supposed to get the most it can out of each pound of fuel and for this reason is supposed to make any savings in fuel that may be made. There is no question that the mechanical department can by proper instruction of its engine crews and by keeping the steaming qualities of its locomotives up to standard, keep the fuel bill down, but beyond that its hands are tied.

There is a great deal more to the fuel problem than burning the fuel. While large economies can be made by proper methods of firing and by good locomotive design, there are great possibilities for economies in the purchase, distribution and handling of the fuel. It should, therefore, be apparent that by bringing these matters under one head better all-around results will be obtained. It is far easier to convince an officer who is responsible for all fuel matters that certain grades of coal should be used on certain divisions than to convince an officer who is only responsible for the money spent for fuel. It is also easier to co-ordinate all the various problems entering into decreased fuel bills by

holding one department responsible than by having the responsibility spread over various departments.

**Need for the
Utilization
of Scrap**

For several years past much interest has been shown in the reclamation of scrap and many railroads have gradually built up extensive plants for the repairing and reworking of the numerous classes of material which accumulate at the scrap yards. During this development attention has been directed in these columns to the danger of overzealousness in reclaiming scrap material. Because of a lack of an adequate system of accounts, figures for the cost of reclaimed material often have been inaccurate and have led to the extensive use of material which could have been purchased new in the open market to better advantage. This situation, however, has been remedied in a large measure by the introduction of better accounting methods and more careful supervision of the work of scrap reclamation, and at the present time the great need is for a more extensive use of reclaimed material than has ever before been attempted. Owing to the unusual demand for iron and steel products of all kinds, much difficulty is being experienced and will continue to be experienced in securing necessary materials for use in maintaining both cars and locomotives, in quantities sufficient to meet the demand. Wherever such material may be secured from the scrap yard, its use may be of considerable advantage in assuring a continuous and adequate supply of certain classes of material, irrespective of the cost of working it over in the reclamation plants. However, with many of the materials involved showing increases in price during the past two years of anywhere from 100 per cent to 300 and 400 per cent, no fear need be felt as to the financial justification of such a policy.

No matter how extensively reclaimed material may be used, there are always large quantities of material passing through the scrap yard which must be sold. The prospects are that during the coming winter the demand for many classes of scrap material will be unusual because of the inability to secure an adequate supply of ore from the Lake Superior mines before lake navigation closes. The railroads being among the large sources of scrap supply may, therefore, perform an important service by seeing to it that all useless material is collected and sent to the scrap yard, where it may be available for the market as the need arises.

**Keeping the
Valuation
Up-to-Date**

The problem of devising a method of keeping the valuation of shop equipment and rolling stock up-to-date is one which is troubling the mechanical departments of the roads that have completed the valuation. It is extremely difficult to secure enough clerks to do the work properly, yet it is essential that the valuation be kept up-to-date in order that it shall never be necessary to duplicate what has already been done. The methods followed by the roads in the past in keeping a record of charges to capital account will not satisfy the requirements of the Interstate Commerce Commission. In the majority of cases where past records have been checked in connection with the valuation work it has been shown that the systems formerly in use did not result in the proper charges being made. Many items properly chargeable to capital account have been charged to maintenance of equipment. It is to the interest of the roads to keep the charges properly distributed and a careful check of any new system which is adopted should be made to see that it actually does insure correct distribution.

The charges for new shop equipment and rolling stock can usually be handled with comparatively little trouble, but the accounting system often fails to secure the proper division between the charges for repairs and those for additions and betterments to equipment. In handling these accounts

it is often necessary to depart from the usual practice and provide some definite check on the work.

On one road a special arrangement has been made which it is believed will insure the correct separation of charges without making it necessary to employ a man to check the individual items. A record of the cost of making an addition or betterment to a single locomotive or car is carefully checked. The cost of this single operation and the amount chargeable to capital account are recorded as standard charges. The work done in the shops is not separated between the accounts at the time it is done but a record is kept of the number of cars or locomotives to which each addition or betterment is applied. At the end of the month the total charges to capital account are computed from the records of additions and betterments and the unit costs. The sum thus secured deducted from the total charges gives the amount to be charged to maintenance of equipment. A scheme of this sort could be used in nearly any shop with but slight expense and the results should be better than are obtained where charges are apportioned by the workmen or by shop clerks.

**False Economy
in Locomotive
Repairs**

The present scarcity of skilled railway mechanics creates a strong temptation to slight repair work in the shops in order to secure greater output. It seems necessary at this time to sound a warning regarding some of the short cuts that are now being put into practice. One of these methods of speeding up work which can hardly be called new but is now being used more extensively than heretofore is setting valves without putting rollers under the main wheels. There is no question that such procedure saves time but when locomotives are repaired they should be put into condition to operate at their maximum efficiency and this object is not secured unless the valves are set accurately.

The proportions of the valve gear which give the best results in locomotive service have been determined by careful experiment. If valves are set without determining any of the events and merely equalizing the travel, the benefits of correct design are lost. The slight amount saved in the shop by reducing the work involved in setting the valves is offset many times by the cost of the extra fuel consumed by locomotives which do not have the proper steam distribution. It may be argued the enginemen can determine by the sound of the exhaust whether the valves are set properly. At best, this is merely a check on the point of cut-off and is useful only in showing whether an equal distribution of power for each stroke is secured. It gives no indication as to the lead or the point at which cut-off takes place. Furthermore, locomotives equipped with superheaters are usually worked at such long cut-offs that irregularities cannot be determined by the sound.

Quite as bad as inaccurate methods of setting valves is the practice of deviating from standard dimensions at the whim of the valve setter or the enginemen. At one of the shops on an eastern road the man who was employed as valve setter had his own theories regarding the proper proportions for the valve motion. He maintained that plenty of lead made a smart engine, consequently he set the valves on all locomotives with $\frac{3}{8}$ in. more lead than was specified in the standard instructions. This man had considerable prestige as a valve setter among the shop men and no one saw fit to insist that he adhere to the standard. If the effect of his practice on the fuel consumption of the locomotives had been apparent the valve setter would no doubt have seen the error of his policy.

It is unfortunate that railroads so seldom apply indicators to locomotives in order to determine the actual steam distribution. It seems probable that if indicator cards were taken periodically a marked gain in fuel economy would result. Unfortunately the roads are not in a position to put such a method into practice, particularly at this time. Every shop can, however, do its part to insure that fuel will be used economically by adhering to standards and by seeing that the valve motion is put in the best of condition.

COMMUNICATIONS

A FOREMAN'S PLEA

THE WEST.

TO THE EDITOR:

Can your journal not use its influence against the shabby treatment that some railways accord their foremen in the matter of wage adjustments?

We see our men given increases in pay when conditions justify, but the foreman's wages are stationary, except for those on the hourly rate, who are legislated for by the labor organizations. Such grievances are the making of advocates of government ownership. As matters are now we seem to have no system of compensation, but the matter is left to the personal preferences or friendship of some person higher up.

A FOREMAN.

TOBESURA WENO "BACK ON THE JOB"

(With Apologies to Wallace Irwin.)

CHICAGO, Ill.

Dear Editor:

Since previous epistle, I am completely exonerate, restore to job with salute, profound assurance of faith my loyalty, honor and ability. Kind friends in office of Chief also present me with Iron Cross decorate with ribbons, although I are little worry about elaborate excuse for not displaying appropriate inscription. Friends say it constitute treason to U. S. A. to give real Iron Cross so substitute one made in America are present. In fact, accurate picture my decoration shown in Crane catalog page 593.

My dealing with you are also excuse as Hon. Members of Congress declare that press must be free in glorious republic, that it shall not be gag like Russian vodka or Berliner Zeig-fest.

On assuming job, I receive S. O. S. summons from secretary of Lodge 41,144 to help save overwork brothers. He advise engines all shot to pieces, round-house foreman won't

do work and trainmaster working everybody to death so can't make garden and reduce high cost to live. I report on job Monday a. m. and immediately place five engine on Form 5 roll of honor relating following history on each:

Engine 421-R. drive flange 1-11/16 in. big wide gash in mud ring corner which are leaking and wearing hole in ashpan.

Engine 468.—Hole in stack which are also not sitting up straight, 6-in. flat spot on tender chafering iron, draw-pin have 3/8-in. slot wore up and down, angle bar in right back corner firebox instead of grate which are missing.

Engine 394.—Right side-bearing tank gone entire, cistern leaning on one side instead of both making dangerous condition, brake beam safety hanger bracket bolt thread strip and tap lost off.

Engine 381.—Lubricator dirty, water glass lime up so unintelligent to read, gage cock leaking on top stuck below, engineer seat box cushion spring resolutioniency missing and front cab window too dirty for vision.

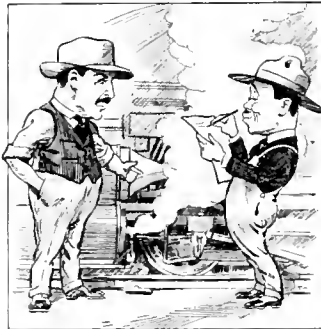

"It are not New Packing Imperial Government Desire to Inflict but Tight Joint."

Engine 413.—Reverse rod come back hard go ahead easy which make engineer lay off for lambago in back, two flues plug, patch leaking fierce, packing gone both piston rod and headlight insufficient in mean spherical candlepower.

I hope this report satisfy brother Secretary, but not so—he say mm won't do work and should come back tomorrow unexpected. I return as he require and first thing see whole front engine 413 envelope in steam. I commence to inscribe Form 5 when mm appear in excitement. He say wait and confiscate wandering machinist. We take stuffer box and cup out and he point triumphant to brand new packing. I reply it are not new packing imperial government desire to inflict on railroad but tight joint. He remark solo voice it can't be done. I resume writing while mm inquire uneasy about course. I converse gently explaining that rod wore 1/32 in. in hollow which require turning down and respectively make such recommendation on Form 5 which I hand out polite all the time grieving inward.

I are unable to see brother Secretary again, but hope he become satisfy over this cup-de-tete.

Yours truly, TOBESURA WENO.

TOOLS FOR THE WORKMEN

PARIS, France.

TO THE EDITOR:

Having worked for many years in the shops of American railroads and thus being acquainted with the methods followed in supplying the workmen with the necessary working tools, I am taking this opportunity of telling how the French railroads handle this matter for the purpose of showing, what was in my case, a delightful contrast.

When I obtained work as a machinist in the shops of a French railway I was given a locker and a large tool drawer, both equipped with good locks. Then I went to the tool room and obtained a good number of files and chisels, center punch, hammer, goggles, two large cloths (used instead of waste and exchanged for fresh ones once a week), a pound of soft soap to wash with, and a list of all the things that were given to me. This list was to show what I was responsible for and, should I resign, the tools would be checked against it and any missing would have to be paid for. The tool room was splendidly equipped with everything a machinist could possible want and all tools were kept in first class shape. The best thing of all was the fact that no one did any stealing of tools and the consequence was much smoother working, less delay and less disputes. This also applied to locomotives—there was no robbing of one locomotive to supply the needs of another. A large bench was provided for the various parts removed from a locomotive and it was rare to find anything missing when the time came to put them back. The helpers received the same equipment as the machinists.

One good feature is that each gang foreman has his own supply of standard studs, bolts, nuts, washers and cotter pins, with the result that these things could be obtained quickly. The gang foreman is always sure to have the unused ones picked up to return to his cupboard. With the usual American system, the workman usually gets an order for more than he wants, so as to be on the safe side, then has to go perhaps a hundred yards or more to the storeroom to get the material and any nuts, etc., that are left over are usually swept up with the rubbish.

W. G. LONDON.

NORMAL WORLD PRODUCTION OF COAL.—A compilation made by the National City Bank gives the coal production of the world, during the recent normal years, as 1,500,000,000 tons, 38 per cent of which was produced in this country, 21 per cent in Great Britain and 20 per cent in Germany. Great Britain has exported 75,000,000 tons in normal years, the amount in 1916 having been reduced about half. The United States exported 31,000,000 tons in 1916.



Passenger Tank Locomotive, London & North Western

MODERN BRITISH TANK LOCOMOTIVES

Large Numbers of These Engines Are Used to Move Both Passenger and Goods Local Traffic

BY E. C. POULTNEY

Mem. Am. Soc. M. E.; A. M. I. M. E.

ALL the railways in Great Britain use considerable numbers of tank engines for local passenger and goods traffic and the tabulated statements of dimensions accompanying this article gives particulars of the wheel arrangements mostly favored at the present time, together with the principal dimensions of a number of modern engines. The most usual type of tank engine for passenger service till recently has been the 2-4-2 type, and large numbers are still to be found on most lines. Possibly the most notable example of this type of engine were those built by J. A. F. Aspinall for the Lancashire & Yorkshire, which line probably operates more passenger trains by tank engines than any other railway in England. Of the passenger train mileage on this road 56 per cent is operated by tank locomotives. These engines were the first to be built by Mr. Aspinall and were the first Lancashire & Yorkshire engines to be fitted with Joy's valve motion, which has been the standard on this line ever since. They had inside cylinders 18 in. by 26 in., 5 ft. 8 in. four-coupled wheels, leading and trailing radial axles, 1,216 sq. ft. of heating surface and a steam pressure of 160 lb. At the time of their introduction they were among the most powerful tank engines in Britain and did excellent work on a road running through a thickly populated country. Several of them have been rebuilt and fitted with the Belpair boilers, Schmidt superheaters and 20½-in. cylinders. So far as short distance goods traffic is concerned, the type of engine most used is the 0-6-2 design and nearly all railways have numbers of these engines. In general, they are not particularly large as a big boiler together with side tanks of ample water capacity cannot be carried on eight wheels, and a total heating surface of 1,300 sq. ft. and 18-in. cylinders marks the limit that can be reached with this wheel arrangement; hence, the 2-6-2, 4-6-0 and 4-6-2 types are finding favor, these designs being used for both passenger and goods traffic. Generally, the details of design follow the practice of the particular railway on which the engines operate, standard parts being used as much as possible. Superheaters are much used and where track troughs are available, water scoops are provided, so

arranged that they may be used when the engine is traveling either funnel or bunker first. So far as yard service is concerned, many lines use eight coupled engines either of the 0-8-0 or 4-8-0 type, the later design having been recently introduced on the North Eastern Railway, but it safely can be said that most of the shunting service is still performed by engines of the 0-6-0 or 0-6-2 type.

There are several different designs of radial axle box in use for supporting the front and rear ends of tank engines. The type used on the London & North Western, Lancashire and Yorkshire and some other lines, is what is known as the Webb pattern. In this design the axle box is made of cast iron and extends across the full width of the engine. The axle boxes are fitted with bearings in the usual way and the connecting piece between the boxes proper is of an inverted U section, wide enough to span the axle. The axle box works in curved pressed steel guides ⅞ in. in thickness bolted to the main framing of the engine. The box is kept central when on a straight track by two right and left hand coiled springs between the main frames under the axle and within the framing of the guides. The movement is limited to 1¼ in. in either direction. The weight on each journal is taken by laminated springs placed above the axle in the usual manner. A pin extends downward from the spring buckle to the top of the axle box; a suitable sliding piece fixed at the end of the pin slides on a flat surface on the top of the box whenever it is deflected in either direction.

Another form of radial box much used consists of two axle boxes made of cast iron of ordinary construction connected together transversely by two steel plates disposed on either side of the axle. The radial motion of the arrangement is obtained by allowing it to swing about a centre pin suitably placed on the longitudinal centre line of the engine to which it is attached by radius rods formed somewhat like a Y, the extremities of the equal legs being attached to each axle box and the single end being suitably formed for working around the center pin. Strong coiled centering springs are mounted on a transverse piece fitted

between the main framing of the engine and an attachment on the radial box. The axle boxes do not work in the usual horn blocks as the radius rods hold them in position and there is sufficient play in the radius rod where it is attached to the centre pin to permit of the rise and fall of the axle boxes due to inequalities in the road. The springs are of the laminated type mounted above the boxes and a pin extends from the buckle and bears on a flat plate sliding on the top of each box.

The latest practice on the Great Western, Great Central

its upper surface spherical and machined all over rests on the cross stretcher casting, a suitable rectangular extension on its lower surface fitting into the rectangular cavity in the stretcher casting. Under the inside cylinders is the center casting on which the bogie turns; this center fits into the intermediate casting just described. In the rectangular cavity of the bogie frame stretcher at each side of the rectangular extension on the intermediate casting are disposed coiled compression springs. They hold the bogie central but allow for a limited lateral movement, the turning or



Great Central Passenger Tank Locomotive

and Great Northern is similar to American practice in the design of two-wheeled trucks, the radial movement being controlled by radius rods working from a fixed centre and the centering being done by swinging links. Where four-wheeled "bogies" or trucks are used, they are, in general, similar to those used for tender engines. The London & North Western standard bogie provides for a circular turning movement round a centre and for a lateral movement, which takes place between curved guides, the control of which is effected, by means of coiled springs. The most

circular motion being obtained by means of the center just described. Suitable oil grooves are cut in the working surfaces and lubricators are provided for supplying oil. This bogie is the kind most favored and is known as the Adams bogie. It is a strong construction and results in a steady running bogie. More recently some designers have made use of the American swinging link arrangement for taking care of the lateral motion, but this arrangement is exceptional.

Some engineers employ side bolsters for the bogies, this

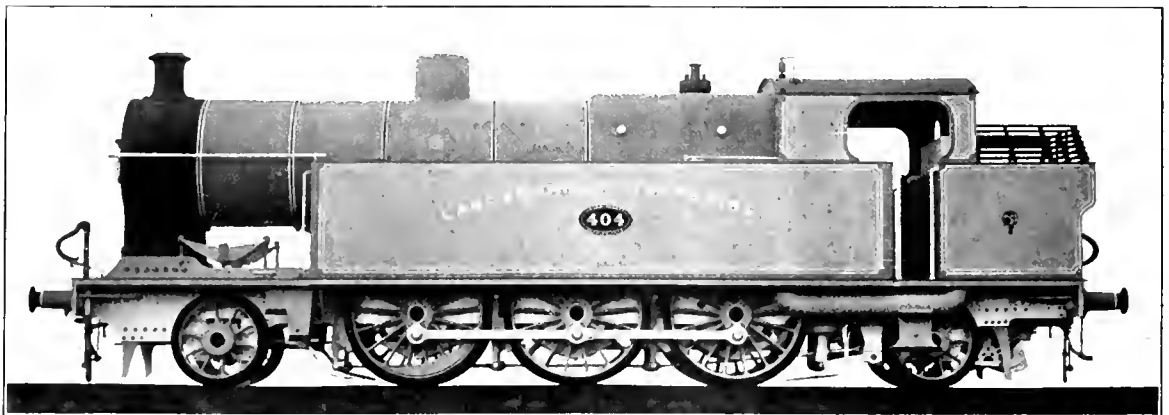

Tank Locomotive for Passenger Service, Lancashire & Yorkshire

usual form of bogie is arranged so that lateral movement between the truck and the center pin take place in a straight path at right angles to the longitudinal center line of the bogie. The bogie is built up of two side plate frames held by a central casting the upper part of which has a machined surface. This casting is divided transversely by a rectangular cavity which extends nearly the full width between the bogie framing. A casting having

practice being much used on the Great Western Railway. The new "Baltic" type tank locomotives in service on the Brighton Line have side bolsters fitted to the four-wheeled bogies.

A number of noteworthy examples of tank engines of modern design are referred to in the table and illustrations. Some of these engines are quite exceptional, particularly the 4-6-4 locomotives for the London, Brighton & South

DIMENSIONS AND PROPORTIONS OF MODERN BRITISH TANK LOCOMOTIVES

Railway	London & No. Western		Great Central		Lancashire & Yorkshire		North Eastern		Great Western		London, Brighton & So. Coast		North British		London and So. Western		Midland		
	4-4-2	4-6-2	4-6-2	2-6-4	2-4-2	2-6-2	4-4-4	4-8-4	4-6-2	4-4-2	2-6-2	2-8-0	4-4-2	4-6-2	4-6-2	4-4-2	4-4-2	4-6-2	
Type	10 by 26	20 by 26	20 by 26	20 by 26	18 by 26	19 by 26	18 by 26	18 by 26	18 by 30	18 x 30	21 by 26	21 by 26	18 by 26	18 by 26	18 by 26	18 by 26	18 by 26	18 by 26	
Cylinders, number	6	5	5	5	5	5	5	5	5	5	5	5	5	5	5	5	5	5	
Cylinders, size, inches	5' 8"	5' 8"	5' 8"	5' 8"	5' 8"	5' 8"	5' 8"	5' 8"	5' 8"	5' 8"	5' 8"	5' 8"	5' 8"	5' 8"	5' 8"	5' 8"	5' 8"	5' 8"	
Combined wheels, dia.	37 1/2	37 1/2	37 1/2	37 1/2	37 1/2	37 1/2	37 1/2	37 1/2	37 1/2	37 1/2	37 1/2	37 1/2	37 1/2	37 1/2	37 1/2	37 1/2	37 1/2	37 1/2	
Steam pressure, lb. per sq. in.	17 1/2	17 1/2	160	180	160	180	160	175	195	195	180	200	160	170	170	175	150	175	
Heating surface—																			
Firebox, sq. ft.	1,778	947.4	1,204	1,390	1,108.73	1,877	934	1,169	907	907	1,228	850	850	1,324	1,214	1,067	1,206	1,206	
Superheater, sq. ft.	161	338.0	341	357	407.68	161	124	141	155	155	185	405	405	382	341	341	341	341	
Total, sq. ft.	1,939	1,333.6	1,649	1,851	1,216.41	2,038	1,058	1,310	1,062	1,062	1,413	1,255	1,255	1,606	1,555	1,408	1,547	1,547	
Total equivalent, sq. ft.	317	1,437.7	1,756	2,003	1,467	2,206	1,182	1,450	1,218	1,218	1,598	1,660	1,660	2,021	1,914	1,767	1,888	1,888	
Grate area, sq. ft.	173.5	231.9	21	26	18.75	26	23	23	23	20.5	20.5	24	24	26.7	26.7	20.3	21.1	21.1	
Maximum tractive effort	17,510	21,600	21,600	21,600	18,800	21,800	33,800	35,800	35,800	31,500	31,500	19,580	19,580	20,800	24,300	17,000	16,600	16,600	
Weight on coupled axles	4,707	5,500	4,700	5,000	4,700	5,000	5,400	5,800	5,800	5,200	5,200	5,280	5,280	5,280	6,120	4,900	4,800	4,800	
Water capacity, gal.	1,702	1,700	2,280	3,000	1,300	2,800	2,000	2,000	2,000	2,000	1,800	2,100	2,100	2,300	2,700	1,900	1,300	1,300	
Banker coal capacity, tons	2.5	3.0	4.0	4.0	3.75	4.0	4.35	5.0	3.0	3.0	3.0	3.0	3.0	3.0	3.0	3.0	3.5	3.5	
Weight on coupled axles, lb.	88,480	98,560	77,831	118,007	89,640	124,544	82,880	121,672	156,800	156,800	85,130	135,440	136,665	118,360	118,360	90,000	119,164	119,164	
Weight, total in working trim, lb.	167,440	173,480	191,640	212,800	131,377	173,628	189,610	195,276	168,000	169,130	174,260	163,730	163,730	163,730	163,730	154,056	154,056	154,056	
Superheating surface as a per centage of the total	8.5	25.3	21.2	20.5	15.2	7.7	9.2	11.4	15.2	15.2	12.8	21.3	21.3	18.5	18.5	23.4	23.4	23.4	
Cylinder vol. per mile divided by heating surface, actual	2.33	4.18	3.32	3.74	2.49	4.26	6.41	5.17	4.31	4.28	4.28	4.13	4.13	2.83	2.83	3.41	3.41	3.41	
Heating surface, equiv.	201	253	260	266	242	246	365	372	334	337	337	221	221	210	210	270	270	270	
Grate area	5.12	4.30	5.6	7.3	4.6	5.5	4.3	4.3	3.48	4.15	4.97	4.35	4.35	6.03	6.03	6.77	6.77	6.77	
Wt. on coupled wheels divided by total engine weight divided by heating surface, actual	86.4	139.3	116.1	114.2	108.0	85.0	142.3	141.0	118.5	138.5	139.0	127.8	127.8	103.4	106.0	118.0	102.0	122.0	
Heating surface, equiv.	118.5	118.5	109.0	105.6	105.6	129.3	129.3	129.3	128.8	129.5	104.1	114.0	114.0	95.0	97.0	118.0	102.0	122.0	
Weight on coupled axles as a percentage of the total engine weight	89.0	57.2	63.3	63.5	58.2	68.0	47.5	72.7	63.7	49.3	71.6	90	52.6	64.7	57.8	74.5	53.0	73.5	

* Equivalent heating surface is obtained by adding a value equal to 1.5 times the superheating surface to the total evaporative heating surface.

† Mean pressure assumed to be equal to 85 per cent of the boiler working pressure.

Coast, which have a maximum tractive effort of 24,250 lb. and weigh 220,000 lb. in working trim.

The London & North Western uses two types of tank engines for passenger traffic. The 4-4-2 engines are generally similar to the 4-4-0 express engines in use on the line except that the coupled wheels are 6 ft. 3 in. in diameter instead of 6 ft. 9 in. The cylinders are between the frames and have their valve chests on the top, the two cylinders complete with steam chests being one casting, which is usual practice in British design. Joy valve motion and semi-balanced flat valves are used, and the crank axle is built up and has a central bearing in accordance with Crewe practice. Four coil springs take the weight on each journal of the coupled axles and laminated springs take the weight on the trailing radial axle box and on the bogie wheels. The vacuum brake apparatus is used, the equipment consisting of a large ejector for creating the vacuum and an air pump for maintaining it while the train is in motion. The engines are doing excellent work in the London, Birmingham and in the Manchester districts. The most recent engines introduced have six coupled wheels, a leading bogie and trailing wheels with radial axle boxes at the trailing end under the bunker. These engines have the first Belpair boilers to be applied by the London & North Western and are also fitted with Schmidt superheaters. In general, they are designed in accordance with modern Crewe practice. The fittings include a mechanical lubricator for the valves and pistons taking its motion from one of the cross heads. The back plate of the boiler is covered; this is not usual.

On the Great Central Railway several classes of tank engines are in use and the latest designs represent very powerful engines. The 4-6-2 engines are used for passenger service and the 2-6-4 type are intended for heavy coal traffic, but are fitted with the vacuum brake apparatus and are thus available for passenger traffic if required. The 4-6-2 engine has inside cylinders and 10-in. piston slide valves on the top of the cylinders, which are operated by the ordinary link motion through the medium of rockers. The engine has a Belpair boiler with a 21-element superheater of the Robinson type. The lubricating of the valves and pistons is done by a mechanical lubricator driven from one of the cross heads and having eight feeds. The 2-6-4 engines are fitted with boilers which duplicate with those of the large 4-4-0 express engines recently described. The cylinders are between the frames and the piston valves are driven through rockers by the ordinary link motion. The connecting rods are milled out to an I section and the big ends are formed by slotting out the end of the rods and fitting in brasses which are held in position by a cap held by two 2 1/4-in. bolts. A steam brake applies blocks to the coupled wheels and two blocks to each of the wheels of the four-wheeled bogie. The brake on the bogie is applied by two steam cylinders, placed one on each side between the wheels. Each cylinder has two pistons and the brakes are applied by admitting steam between them, a suitable spring arrangement being provided for releasing the brake blocks.

The Lancashire & Yorkshire, besides using the 2-4-2 engines, already mentioned, have in service a number of large 2-6-2 engines, one of which is illustrated. The engines at the time of their introduction were the largest tank engines running in the country. These engines have inside cylinders, with their valve chests above. Semi-balance flat valves are used, driven by the Joy valve motion. The leading coupled axle is the crank axle and is of the built-up type. The leading and trailing ends are carried by radial axles. The water scoop is operated by a vacuum cylinder very like those used for the brake equipment.

Several classes of tank engines are employed on the North Eastern Railway both with two and three cylinders. The

latest type has three cylinders, and particulars of these will be found in the table of dimensions. The passenger engines are of the 4-4-4 type. The three cylinders, together with their valve chests, are cast in one piece. The leading axle is the crank axle and the crank pins are 120 deg. apart. Three sets of link motion, the reversing of which is done by a steam gear, operate the piston valves direct, giving outside

The 4-8-0 engine is for yard work and is similar in the arrangement of its motion to the passenger engines except that the valve for the centre cylinder is driven through a rocking lever, which, as the valves have end admission, necessitates the use of crossed rods. The same arrangement is used on the 4-6-2 engines. In each case the leading coupled axle is the crank axle. For yard work and general



Three-Cylinder Tank Locomotive for Passenger Service, North Eastern Railway

admission. The valve for the centre cylinder is on the top with its axis inclined downwards to the centre of the crank axle. The valve chests for the outside cylinders are inside the frames at the side of their respective cylinders. The two four-wheel bogies are alike. Each journal is provided with two coil springs taking the weight through cross beams spanning the axle boxes. The leading springs of the

service of an intermittent nature three-cylinder engines seem to offer distinct advantages. They are less complicated than four-crank arrangement and the writer favors their more general adoption, either with simple or with compound cylinders.

The 0-6-4 engines used by the Midland were introduced to take the place of 0-4-4 locomotives originally used. They



Great Western 2-6-2 Passenger Tank Locomotive

leading bogie and the trailing springs of the rear bogie are made more resilient than the other bogie springs and it is claimed that this arrangement enables the engine to travel over the road more easily. The engines are fitted with the Westinghouse brake equipment which works the brake on the engine as well as the train.

are doing excellent work, especially in the Birmingham and Manchester districts. In the Manchester district they handle trains which load up to 200 tons behind the engine over ruling grades of 1 in 100 to 1 in 130 at 31 miles per hour, including stops. About Birmingham they haul 130-ton trains over grades of 1 in 75 to 1 in 165, at 35 miles per hour,

including stops. The cylinders are between the frames and have flat valves working in chests between the cylinders and operated by the ordinary link gear. A steam brake and steam sanding gear is provided. The wheel splashers and the motion plates are formed from pressed steel, a most unusual practice.

On the Great Western several types of tank engines are in use, the most modern of which are illustrated. The 4-4-2 engine is for passenger traffic, as is also the 2-6-2 engine. These engines follow closely the standard practice of the road in all particulars.* The Belpair boiler with tapered barrel will be noticed, also the cast saddle on which rests the smoke box. The 2-8-0 engines are used for heavy coal and other traffic, and so far as the writer is aware, are the only tank engines of their type in Britain. The coupled wheel base is 20 ft. and in order to ease the locomotive when passing around curves, the trailing wheels are allowed one inch side play on each side of the engine. The knuckle joints in the coupling rods are fitted with spherical bearings.

The greatest development in tank locomotive design has, undoubtedly, taken place on the London, Brighton & South Coast and recent engines are enumerated in the table in the order of their appearance. The 4-4-2 engines were introduced some years ago and showed that still larger engines might be utilized with the result that the 4-6-2 type appeared.

on the bogie wheels through the medium of cross beams spanning the axle boxes. Both the front and rear bogies are identical.

The cylinders are fitted with a special design of automatic by-pass and air valves. The device consists of two small cylindrical castings, one placed inside and concentric with the other. The inner chamber is fitted with a small piston, the upper side of which bears against the rounded end of the stem of a small disc valve which seats on a port in the main cylinder barrel. The under side of the piston is connected by a small pipe to the main steam chests. The outer castings of the two valves required for each cylinder are connected by a suitable pipe and at the bottom of the outer casting is fitted a small disc valve which opens inward and is supported by a light coil spring. On steam being admitted to the main steam chests, the small pistons hold the relief valves to their seats. When, however, steam is shut off, these valves fall and thus establish connection between the two ends of the cylinder. Should there be a tendency to form a vacuum, the valve at the bottom of the outer casing allows air to enter freely.

The reversing of the engine is effected by a screw and wheel gear. The screw passes through a cylinder supported on trunnions and containing a piston and hollow piston rod engaging with the main screw. Air from the Westinghouse brake system is admitted to the front side of this

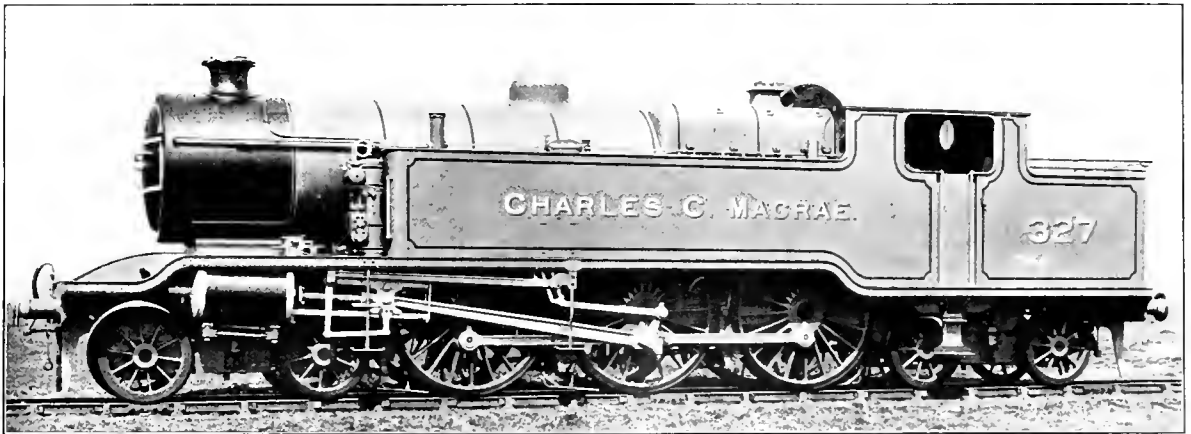

Tank Locomotive for Express Passenger Service, London, Brighton & South Coast

This differs mainly in the location of the cylinders which were inside in the 4-4-2 engine and outside in the 4-6-2 design; both have Schmidt superheaters, piston valves and link motion. The 4-6-2 engines have now been followed by 4-6-4 engines, which are the largest engines of their kind in Britain.

The present engines have been built at Brighton by L. Billington for working express trains between London and Brighton and London and Portsmouth. The boilers have Belpair fire boxes and Schmidt superheaters of 21 elements. The cylinders are outside and drive on to the second coupled axle. Walschaert valve motion is used, working piston valves in valve chests between the frames. The motion is transferred by means of rocking shafts having a short lever at each end and on the same side of the centre line. The feed water in the tanks is heated by part of the exhaust steam. A Wier feed pump is placed on the left-hand side of the engine in front of the side tank, and a hot water Gresham & Craven injector is mounted on the fire box back plate. Two coil springs to each axle box take the weight on the coupled axles and two coil springs to each axle box take the weight

piston, so that in moving it forward to raise the connecting links, the driver is assisted by the air pressure. The gear is held in the required position by a clamp on the reversing shaft, also operated by air pressure. A small handle working a three-way cock is mounted in a convenient position near the reversing wheel for controlling the air supply to the reversing cylinder or to the clamping cylinder, as desired. In its central position the cock puts both these cylinders in communication with the atmosphere, in the second position air is admitted to the clamping cylinder to hold the gear and in the third position air is exhausted from the clamp cylinder, thus freeing the gear and at the same time air is admitted to the reversing cylinder to assist in raising the links.

The North British and the London & South Western engines, referred to in the table, are not large engines. They are, however, in point of power, representative of many tank locomotives running on other lines. The London & South Western engine has inside cylinders with valves and motion similar to the North British engine. It has, however, a built-up crank axle, having the crank webs extended to form balance weights and no balance weights are placed in the wheel centres. This engine is fitted with a feed water

* For more details of Great Western practice, see the *Railway Mechanical Engineer* for November, 1916, page 552, and December, 1916, page 621.

heating arrangement consisting of a number of tubes placed in the side tanks through which is conveyed part of the exhaust steam, the water thus heated is delivered by a duplex steam pump placed under the running board between the trailing coupled axle and the leading bogie wheels. The pump is direct acting, and has two steam cylinders $4\frac{1}{2}$ in. by $8\frac{1}{2}$ in. and two water cylinders each $3\frac{1}{2}$ in. by $8\frac{1}{2}$ in. The heating surface in the tanks is 234 sq. ft. No injectors are used. It may be mentioned that the subject of feed water heating has received considerable attention in Britain and exhaust steam injectors designed to handle hot water are being used to a considerable extent on many railways with good results. The engine has a steam reversing gear consisting of steam and water cylinders, the latter being used to hold the gear.

The table of dimensions is self explanatory, and a study of it will bring out the characteristic features of British tank locomotive proportions. It will be noticed that in most

CAR AND LOCOMOTIVE PRICES

Figures given by the Interstate Commerce Commission in the appendix to its decision in the Fifteen Per Cent case show increases of from 50 to 150 per cent in the prices of cars and locomotives in 12 months' time. Furthermore, prices have increased about 30 per cent since the first of the year and are still on the upward trend.

A year or two ago a freight car cost about \$1,000 to \$1,500. The Pennsylvania in February paid \$3,742 for a 70-ton hopper car and \$3,555 for an all-steel box car. The Pennsylvania, according to President Rea, wanted to buy 5,000 coal cars. At \$3,742 each the road's reasons for omitting to provide itself with this equipment are apparent.

The railroads of this country up to about the first of June were buying locomotives on a large scale, 1,933 engines in the first five months of 1917 as compared with 1,563 in the same period of 1916. They had to pay as high as \$60,-

CAR AND LOCOMOTIVE PRICES THIS YEAR AND LAST

CARS—		1916		1917		
Road	Type	Price	Date of Order	Price	Date of Order	
Chesapeake & Ohio	Hopper	\$949		\$1,531	October, 1916	
Chicago, Burlington & Quincy	Box	808	Feb. or July, 1915	1,540	November, 1916	
	Gondola	1,637	March, 1915	1,891	November, 1916	
Illinois Central		1,682		2,600		
Northern Pacific	Refrigerator	1,559	(1913)	2,475	January, 1917	
	Gondola	1,042	(1913)	2,175	January, 1917	
Last lots purchased in 1913						
Pennsylvania Lines East	Steel coal	1,466	January, 1916	3,742	February, 1917	
	Steel box	1,500	January, 1916	3,555	February, 1917	
Southern Pacific	Tank	1,468	March, 1916	2,807	February, 1917	
	Gondola	1,295	February, 1916	1,919	February, 1917	
	Combination baggage and mail	9,786	February, 1916	12,319	March, 1917	
Western Maryland	Coal	1,035	October, 1915	1,529	October, 1916	
LOCOMOTIVES—		1916		1917		
Road	Type	Weight	Price	Date of Order	Price	Date of Order
Chesapeake & Ohio	2-6-6-2	435,000	\$31,019	October, 1915	\$48,139	June, 1916
Chicago, Burlington & Quincy	Santa Fe	367,850	26,518	March, 1915	46,450	November, 1916
	Mikado		22,017	March, 1915	42,505	November, 1916
Chicago, Indianapolis & Louisville	Santa Fe	350,000	31,300	March, 1916	59,000	
Delaware & Hudson			Price of a locomotive 25 per cent larger than former ones is 200 per cent higher.			
Illinois Central	Mikado	278,000	22,205	February, 1915	41,661	February, 1917
	6-wheel switching	170,000	12,400	January, 1915	26,756	February, 1917
	Pacific	278,000	27,818	February, 1916	42,935	February, 1917
New York, Chicago & St. Louis	Switching	173,500	19,250	March, 1916	23,375	November, 1916
Norfolk & Western			43,360		77,500	
Quotation not accepted and none bought.						
Northern Pacific	Mallet	456,000	42,025	(1913)	61,200	January, 1917
	Mikado	320,000	27,977	(1913)	42,700	January, 1917
	Mikado	320,000			61,950	April, 1917
Pennsylvania Lines East	Mikado		39,000	Jan. or May, 1916	63,000	February, 1917
Pere Marquette	Santa Fe	320,000	Not shown		56,250	April, 1917
	8-wheel switching	204,000	Not shown		38,900	April, 1917
Southern Railway	Santa Fe	370,000	\$38,400	April, 1916	73,850	May, 1917
	8-wheel switching		25,483		35,850	May, 1917
Toledo, St. Louis & Western	Consolidation	193,000	19,453	December, 1915	24,316	
Union Pacific	6-wheel switching	156,000	14,913	January, 1916	26,780	March, 1917
Western Maryland	2-8-2	495,000	37,276	June, 1915	66,531	October, 1916

NOTE—The figures in the foregoing table were compiled as follows: The name of the road, the prices given and the type of locomotive or car are given in appendices 3 and 5 of the Interstate Commerce Commission's report in the Fifteen Per Cent Case. The dates of the orders, the weights of the locomotives, etc., have been supplied from the records of the Railway Age Gazette.

cases cylinders are much larger in proportion to boiler heating surface than is usual practice with tender engines. This is due to the fact that high power is not required to be developed for long periods of time with engines of this type; it is also due in part to the fact that boiler weight has to be kept down owing to the water tanks being carried on the engine framing. The factor of adhesion is also higher in engines of this type than is usual with tender engines. This feature is of value when making rapid starts, which are necessary in local passenger service and in shunting operations.

The photographs from which the illustrations have been prepared are all by Mr. F. Moore, Finsbury Circus, London, E. C.

000 for Mikado or Santa Fe locomotives, \$35,000 for eight-wheel switching locomotives and \$25,000 for six-wheel switching locomotives. The Norfolk & Western had a chance in May to buy some big Mallet locomotives; but the price asked was too much. The road is now building the locomotives in its own shops. Two other roads are reported to have paid over \$100,000 for Mallet locomotives. The table shows concrete examples of the increase in prices.

SHORTAGE OF SHIPPING IN AUSTRALIA.—During the year ending June 30, 1916, there was a falling off of 83,000 tons of freight on the railways of Western Australia, owing to one million bags of wheat having had to remain stacked in the country districts, owing to the scarcity of shipping.

D. & R. G. SANTA FE TYPE LOCOMOTIVES

Heaviest Non-Articulated Locomotives Ever Built; a New Design of an Automatic Drifting Valve is Used

ABOUT six months ago the Denver & Rio Grande received from the American Locomotive Company ten locomotives of the 2-10-2 type which weigh 428,500 lb. and have a tractive effort of 81,200 lb. Of these, five are being used between Denver and Salida, Col., on through freight trains and five are being used between Minturn and Tennessee Pass, Col., which is at the top of the grade between Minturn and Malta, as helpers. There are many heavy grades and sharp curves. On the line between Denver and Salida the maximum grade is 1.42 per cent with 6-deg. curves, not compensated, and at one point there is a 12-deg. 30-min. curve. Between Minturn and Tennessee Pass the maximum grade is 3 per cent and the westbound track has a maximum curvature of 16-deg. Since the rigid wheel base of these locomotives is only 16 ft. 6 in., no difficulty is experienced in operating on these sharp curves. These locomotives were not designed for helper service, the Mallet type being regularly used for that purpose. Owing to the demands of traffic it was found necessary to use a larger number of helper locomotives and the 2-10-2 type was chosen as best fitted for the work.

In the district between Denver and Salida the traffic

Equivalent heating sur- face	7,362 sq. ft.	3,036 sq. ft.	6,622 sq. ft.
Grate area	88 sq. ft.	49 sq. ft.	80 sq. ft.

In order to make it possible for these locomotives to take 10-deg. curves without trouble, the tires on the first, the main and the last pairs of drivers were set $5\frac{3}{8}$ in. apart. On the second and fourth pairs, the tires are set $5\frac{3}{8}$ in. apart. Lateral flexibility in the driving wheel base is secured by the use of the Woodward floating front driving axle. The front truck has 6 $\frac{1}{2}$ -in. swing either side of the center and the trailing truck 4 $\frac{3}{4}$ in.

The boiler has been carefully designed to secure high capacity. It is of the conical type, being 96 in. in diameter at the first ring. An auxiliary dome is provided to carry the safety valves and the whistle. The firebox is fitted with a combustion chamber 50 in. long and has a Security brick arch. The locomotives have Schmidt superheaters and are fired by Street stokers. There are two blow-off cocks on each side of the firebox and one is placed in the front course of the boiler.

The frames are of cast steel, with a top rail 6 in. by 7 in. increasing to 6 in. by 9 in. over the driving boxes. The front frame rails are 6 in. by 13 in. The Commonwealth

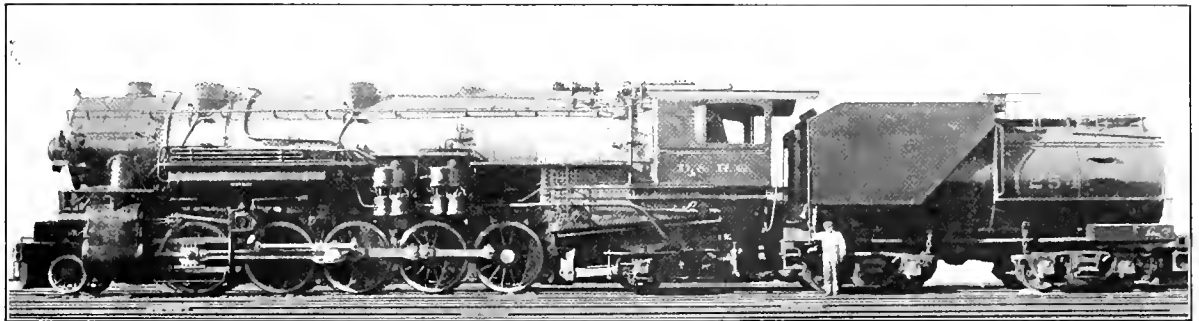

The Heaviest Non-Articulated Locomotive in the World—Denver & Rio Grande

amounts to approximately 80,000,000 ton-miles per month. About 25 locomotives are required to handle this tonnage. In January, 1917, when the consolidation type was being used, the gross tons of freight per locomotive-mile in this district averaged 942. In March, with five of the 2-10-2 type locomotives in service, the average tonnage was 1,068, an increase of 13.4 per cent. While the traffic increased 1.2 per cent as compared with January, 1917, the train-miles decreased 7 per cent and the locomotive-miles decreased 11 per cent.

A tabular comparison of these locomotives with the Consolidation and Mallet types, which are used in the same district, is given below:

Type	2-10-2 Through Freight and Helper	2-8-0 Through Freight	2-8-2 Helper
Tractive effort	81,200 lb.	44,000 lb.	95,600 lb.
Weight in working order	428,500 lb.	220,400 lb.	458,000 lb.
Weight on drivers	337,500 lb.	194,100 lb.	394,000 lb.
Weight of engine and tender	624,900 lb.	378,100 lb.	620,200 lb.
Wheel base, driving	22 ft. 6 in.	15 ft. 8 in.	40 ft. 8 $\frac{1}{2}$ in.
Wheel base, rigid	16 ft. 6 in.	15 ft. 8 in.	15 ft. 0 in.
Wheel base, engine and tender	76 ft. 9 $\frac{1}{2}$ in.	59 ft. 5 $\frac{1}{2}$ in.	91 ft. 3 $\frac{1}{2}$ in.
Cylinders	31 in. by 32 in.	23 in. by 28 in.	26 in. and 40 in. by 32 in.
Driving wheel diameter	63 in.	57 in.	57 in.
Boiler, working pressure	195 lb. per sq. in.	200 lb. per sq. in.	200 lb. per sq. in.
Heating surface, total	5,369 sq. ft.	3,026 sq. ft.	5,125 sq. ft.
Superheater heating sur- face	1,329 sq. ft.	998 sq. ft.

locomotive cradle is used. They have bushings of Hunt-Spiller gun iron, and the pistons are fitted with bull rings of the same material. The piston valves are 16 in. in diameter.

A new device which has been applied to these locomotives is the Vincent drifting valve. This consists of a valve attached on the end of the main valve stem and working in a chamber extending out from the valve head. This chamber is connected to the boiler through an automatic shut-off valve. It is connected to the steam pipe through a check valve.

The operation of the drifting valve is as follows: When the main throttle is opened, superheated steam from the header passes through the pipe shown in the drawing at *T* to the differential valve *B* and closes it against the boiler pressure. When the main throttle is closed, saturated steam from the boiler is admitted through the valve *A* to the differential valve *B*, and thence through a 1 $\frac{1}{4}$ -in. pipe *C* to the drifting valve connection *D* or *E*. It then passes into chamber *F*, through ports *G* into chamber *H*, and through ports *K* into chamber *L* or *M* according to the position of the valve *J*. When the position of the valve *J* is reversed, steam exhausts through the ports *K* and *N*, or *P*, into the chamber *Q*, and thence through the pipe *R* into the main steam pipe and steam chest. A check valve *S* prevents steam from

the main steam pipe entering the pipe R. Drain pipes are provided at the bottom of the chambers L and M.

The tires on all wheels of these locomotives are flanged. The axles are of carbon vanadium steel, the main axle having bearings 13 in. in diameter and 22 in. long, while the front bearings are 11 in. by 19 in. and all others 11 in. by 13 in. The main crank pins have 9 1/2-in. by 10-in. bearings for the main rods and 10 1/2-in. by 5 1/2-in. bearings for

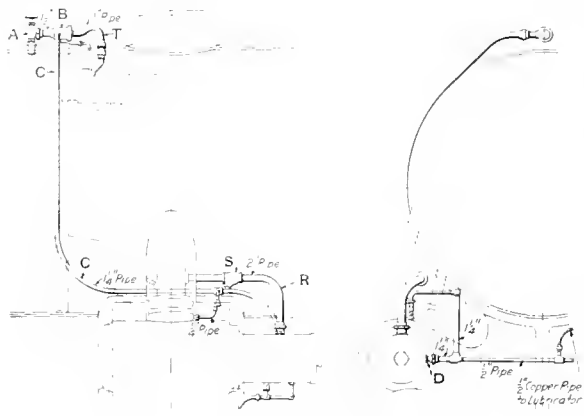

Arrangement of Piping, Vincent Drifting Valve

the side rods. The crank pins, side rods and piston rods are of Nikrome steel. The valve motion is of the Baker type controlled by the American Locomotive Company's power reversing gear.

The brake equipment is the Westinghouse E T, with two 8 1/2-in. air compressors. Two 14-in. by 12-in. brake cylinders attached to the frames behind the cylinders are provided for the first three pairs of drivers. The fulcrums for these cylinders are attached to the frames beneath the cylin-

The principal dimensions and ratios of these locomotives are as follows:

General Data	
Gage	4 ft. 8 1/2 in.
Service	Freight
Fuel	Bit. coal
Tractive effort	81,200 lb.
Weight in working order	428,500 lb.
Weight on drivers	137,500 lb.
Weight on leading truck	31,000 lb.
Weight on trailing truck	60,000 lb.
Weight of engine and tender in working order	624,900 lb.
Wheel base, driving	22 ft. 6 in.
Wheel base, total	41 ft. 5 in.
Wheel base, engine and tender	76 ft. 9 1/2 in.
Ratios	
Weight on drivers ÷ tractive effort	4.16
Total weight ÷ tractive effort	5.28
Tractive effort × diam. drivers ÷ equivalent heating surface*	694.9
Equivalent heating surface* ÷ grate area	83.66
Firebox heating surface ÷ equivalent heating surface*, per cent	5.00
Weight on drivers ÷ equivalent heating surface*	45.84
Total weight ÷ equivalent heating surface*	58.20
Volume both cylinders	27.95 cu. ft.
Equivalent heating surface* ÷ vol. cylinders	263.4
Grate area ÷ vol. cylinders	3.15
Cylinders	
Kind	Simple
Diameter and stroke	31 in. by 32 in.
Valves	
Kind	Piston
Diameter	16 in.
Greatest travel	6 3/4 in.
Outside lap	1 in.
Inside clearance	0 in.
Lead in full gear	3/16 in.
Wheels	
Driving, diameter over tires	63 in.
Driving, thickness of tires	3 1/2 in.
Driving journals, main, diameter and length	13 in. by 22 in.
Driving journals, front, diameter and length	11 in. by 19 in.
Driving journals, others, diameter and length	11 in. by 13 in.
Engine truck wheels, diameter	33 in.
Engine truck, journals	7 in. by 12 in.
Trailing truck wheels, diameter	42 in.
Trailing truck, journals	9 in. by 16 in.
Boiler	
Style	Conical
Working pressure	195 lb. per sq. in.
Outside diameter of first ring	96 in.
Firebox, length and width	132 in. by 96 1/2 in.
Firebox, water space	Front, 7 in.; sides and back, 6 in.
Tubes, number and outside diameter	252-2 1/2 in.
Flues, number and outside diameter	48-5 1/2 in.
Tubes and flues, length	23 ft. 0 in.
Heating surface, tubes and flues	5,001 sq. ft.
Heating surface, firebox	368 sq. ft. †
Heating surface, total	6,369 sq. ft.

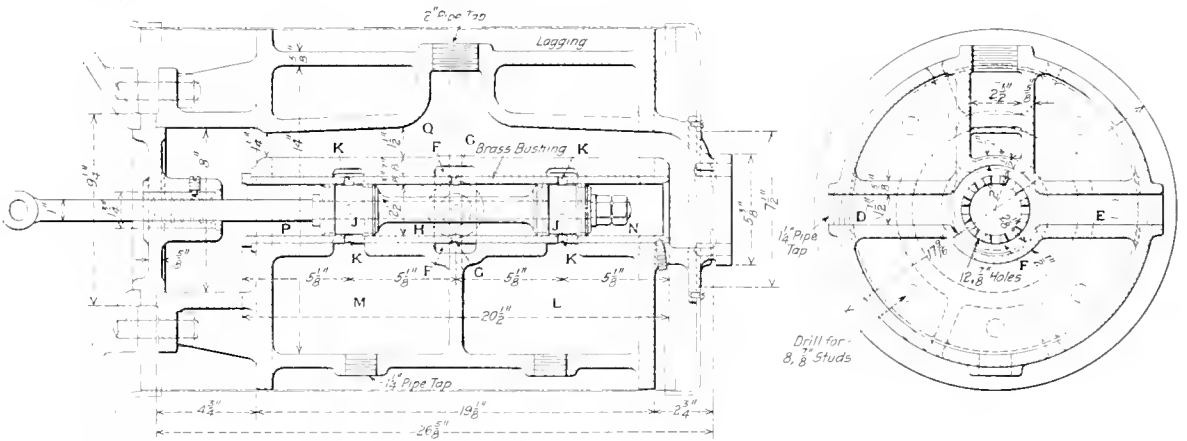

Details of the Vincent Drifting Valve for the D. & R. G. Locomotives

der saddles. The two rear pairs of drivers are braked by two 12-in. by 10-in. cylinders. The tender trucks are provided with clasp brakes.

Among the specialties applied to these locomotives are the Chambers throttle, Nathan non-lifting injectors, Woodward engine trucks, Cole trailing truck, Chicago flange lubricator and Economy radial buffer. The tenders are equipped with Miner friction draft gear, Barber side bearings and lateral rollers, the Lindstrom syphon tank valves and Davis cast steel wheels.

Superheater heating surface	1,320 sq. ft.
Equivalent heating surface*	7,362 sq. ft.
Grate area	88 sq. ft.
Tender	
Tank	Vanderbilt
Frame	Cast steel
Weight	196,400 lb.
Wheels, diameter	33 in.
Journals, diameter and length	6 in. by 11 in.
Water capacity	10,000 gal.
Coal capacity	21 tons

* Equivalent heating surface = total evaporative heating surface + 1.5 times the superheater surface.
 † Includes arch tube heating surface.
 ‡ Includes combustion chamber heating surface.

ROCK ISLAND FUEL DEPARTMENT

Reports to Chief Operating Officer; Controls the Purchase, Distribution and Consumption of All Fuel

THE fuel department of the Chicago, Rock Island & Pacific is unique in that the purchase of the fuel, its distribution, method of handling, and its consumption are in the hands of the mining and fuel department, the manager of which reports direct to the chief operating officer of the road. This brings under one head all questions pertaining to fuel and presents an opportunity for the obtaining of a true fuel economy, cost and consumption considered.

ORGANIZATION

The officers of this department rank as general officers and deal directly with the superintendents of the various divisions. Each superintendent is held responsible to this department for the proper handling and use of fuel. The manager of this department has the following assistants:

1. General superintendents of mines, who look after the operation of the company's coal mines.

2. A superintendent of fuel, who looks after the purchase of fuel, its distribution and handling.

3. A superintendent of fuel economy, who looks after the fuel economy work.

This article deals more particularly with the fuel purchased and no reference to the mining organization is therefore made.

To the superintendent of fuel report five inspectors who look after the preparation of coal and oil, and weights thereof; and the coal chute supervisor and his two inspectors, who look after the handling of coal at fuel stations.

To the superintendent of fuel economy report the engineer of fuel economy, who has a staff of six assistant engineers, and the inspector of stationary boiler plants.

Instructions regarding the use of fuel in locomotive service and at stationary plants emanate from the office of the mining and fuel department. They are sent to the division superintendents for distribution to the assistant engineers of fuel economy, the road foremen of equipment, stationary plant engineers, or whoever is affected by them. All questions which arise on the road concerning fuel are submitted through the various division superintendents to the Mining and Fuel Department.

The duties of the superintendent of fuel are the negotiation of contracts and the purchase of fuel, including coal for locomotives and stationary plants, coke, and oil, and such other special fuels as may be required. His staff looks after the inspection of the fuel, the checkweighing of cars, including surprise checkweighing tests to eliminate carelessness, deliberate or otherwise, one the part of the mine weighmaster.

The fuel inspectors advise the main office regularly as to labor matters and any unusual conditions existing at the mines which may in any way interfere with the prompt delivery of coal. Fuel inspectors also send in samples of coal from the various mines for laboratory test, so that from the information available the most suitable coals can always be selected for the respective requirements.

The duties of the coal chute supervisor are to look after the cost of handling fuel and the operations of the 157 chutes on the system. With his two inspectors he sees that the fuel is handled at the lowest possible cost, and where necessary he recommends changes which will reduce the cost, co-operating with the superintendents on their respective divisions.

The duties of the superintendent of fuel economy and his six assistants are to look after the economical use of fuel on

locomotives, which consists in the instruction of the engine crews in the best method of firing and the supervision of the condition of locomotives as far as they affect the consumption of fuel. This includes the inspection of engines at terminals to the extent that the boilers are properly cleaned inside and outside; that the required size of nozzle is maintained; that all packings are in a condition for best operation.

The fuel economy staff also holds general meetings at the larger centers, where by moving pictures and lantern slides the essential features of fuel economy are vividly brought to the attention of the men using the coal. These instructions include the prevention of obnoxious smoke and other features which are essential to the best results.

The duties of the supervisor of stationary plants are to look after the fuel consumption of the stationary plants and to generally supervise the steam generating plants used for the operation of shops, pumps and for heating. He sees that the boilers are fired in the proper manner and that boilers, steam and air pipes are maintained to prevent leaks which cause an increase in fuel consumption.

The entire staff co-operates in any method which may bring about the most economical results, and while certain assignments of duties are made, there is a general interchange of work on matters which bring about final results; in traveling over the system every employee is required constantly to keep fuel economy before him. The coal inspectors traveling from one mine to the other are required to travel on locomotives in order to note that tanks are not overloaded at fuel stations, which is the particular duty of the coal chute inspectors; in like manner the coal chute supervisors at terminals check the movement of coal cars, loaded and empty.

DISTRIBUTION

The Rock Island uses coal from approximately 70 coal mines. The most economical grade of coal is determined for each point on the system and daily schedules of delivery are drawn up each week in the general office, and the amount of coal to be delivered during the coming week is determined from the previous week's consumption. A coal report is made up in the office of each superintendent daily, the day ending at 6 p. m.; this is wired to the general office before 3 a. m. the next morning. The information conveyed in this report is as follows: Amount of coal in pockets at the coaling stations and on the chutes in cars; number of cars not placed at the chutes; amount of coal used at each station during the preceding 24 hours; number of cars in transit for this and other divisions and to what stations consigned; number of loaded cars with company coal waiting for train, including the stations at which the cars are held and to what station they are consigned; amount of coal received from each individual mine and from junction points; amount of company coal in cars billed from the mines and junction points and to what stations it is consigned; number of cars of company coal loaded at the local mines; number of empty cars delivered to the local mines for company coal; number of cars of company coal received from local junction points with other roads and the number of empty cars delivered to those points; amount of storage coal loaded or unloaded; together with the amount on the ground at the various stations; amount of fuel oil on hand in storage tanks and in cars, and the number in transit at each station. Also the number of gallons of fuel oil consumed during the preceding 24 hours.

This report gives the general office complete information regarding the amount of coal on hand at each station, shows the location of the cars in transit to other divisions and shows whether or not the mines are keeping up with their daily schedule of output.

Under normal conditions, about 1000 cars are required to keep the stations supplied, and this represents about 4 1/2 days' consumption for the system. In addition to this, about one day's supply is kept in the various chutes and fuel station bins. Particular attention is given to the proper utilization of cars, and box cars are frequently used even though the cost of handling is greater, to effect greater car efficiency. Self-cleaning cars are assigned to chutes equipped for mechanical handling, other cars were unloaded by hand.

Special efforts are made to prevent the mixing of coal and to furnish regularly the same grades of coal for use on a given territory.

LOCOMOTIVE PERFORMANCE

To this time no attempt has been made to check the individual performance of each engine crew, but collective statements showing the performance on each division, divided into freight, passenger and switch service are posted in the round houses which show the performance of each division compared with the same month of previous year and the loss or gain reduced to dollars and cents and the respective position which each division occupies toward the

individual performance record, which will be prepared in the office of each division superintendent immediately at the end of each run. The information as to the consumption of coal will be obtained from a slip made out by the engineers showing the amount of coal used on each trip. This fuel consumption slip is a part of the time check and will be handed in at the superintendent's office with the time slip so that the information will be promptly available and enable the immediate compilation of the performance of each engine. This method will obviate the necessity for coal tickets which are now used but from which no satisfactory reports can be compiled.

RESULTS

This organization has been in operation for about a year, and while this period is entirely too short to determine the full possibilities, it may nevertheless be of interest to point to the following comparisons:

For the year ended June 30, 1915, the amount expended for coal for all uses amounted to \$7,168,378.41, and for the year ended June 30, 1916, the corresponding amount was \$6,762,430.88, or a difference of \$405,947.53. This saving was made with an increase in 1000 ton-miles in freight service of 913,866. This indicates a saving of \$826,802.56. In other words, had as much work been done in 1915 as was done in 1916, the fuel bill for 1915 would have been 12.2 per cent greater than it was during the year 1916. It is safe to anticipate that the increased cost of coal due to higher wages calls for intensified work in the direction of fuel economy and that the use of improved mechanical appliances and better firing methods will result in a decided reduction in the quantities consumed, a situation most necessary in view of the rapidly climbing cost of coal.

METHOD OF INCREASING AIR CAPACITY ON DOUBLE HEADED TRAINS

BY E. F. GIVIN

Mechanical Engineer, Pittsburg, Shawmut & Northern

Double heading freight trains has made great reductions in the cost of operation per ton-mile, but at the same time has produced annoying delays, pump failures and breaks-in-two that in many cases can be traced directly to a too small air compressing plant in connection with the desire of the engineman to get over the road in the required time. With the increase in the number of cars in a train, is a corresponding increase in the train line leakage, a large percentage of which cannot be stopped by the train crew. Inasmuch as it is impracticable for both engineers on the locomotives to operate their brakes simultaneously, the air compressing plant of the leading locomotive must take care of the train, including the leakage, as best it can, while the compressing plant of the second locomotive is idle.

On the Pittsburg, Shawmut & Northern the large freight locomotives are equipped with either one No. 5 or two No. 6 New York air compressors, the main reservoirs having a capacity of from 50,000 to 70,000 cu. in. Theoretically this is sufficient to take care of an 80-car train and when on account of the extreme traffic conditions, it was attempted to double head trains, no excessive trouble was anticipated. It soon developed, however, that the capacity of the leading locomotive was not sufficient to produce the proper results and a prolonged car shortage has exaggerated these troubles. It became necessary to devise some means to allay, at least, part of the difficulty. To get the trains out of the yards at terminals it was necessary for the second locomotive to be cut in to assist in charging the train, but this led to various abuses by some venturesome engineers which were dangerous, and it was necessary to abandon the practice.

This made it necessary to either apply more air compressors and reservoirs to the locomotives or to devise some

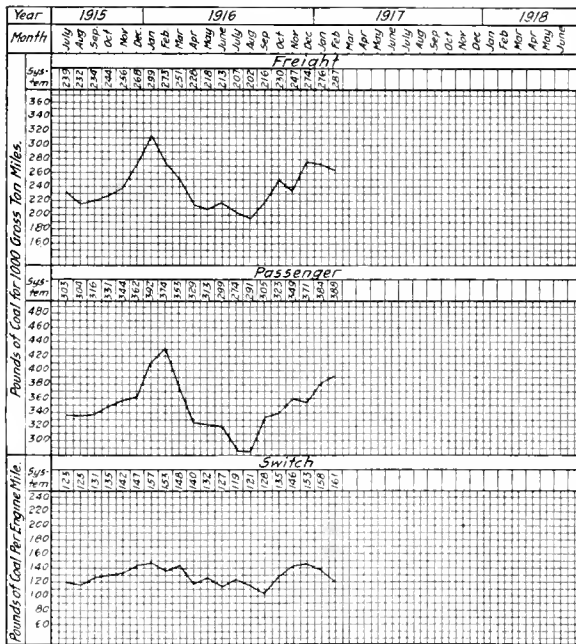

Chart Showing the Fuel Performance of an Individual Division

entire system. These statements are furnished in the shape of graphic charts and in tabulated figures as well. The engine crews are fully informed that these tables do not reflect conditions entirely within the control of the management. There are certain factors, such as the quality of coal available, type and size of engine used, grade conditions, and density, direction and distribution of traffic, which all have an important bearing on coal consumption, but inasmuch as some of these conditions are more or less permanent, any change of conditions is readily observed by the up or down grade lines on the graphic charts, and considerable competition has been developed in this direction.

It is contemplated in the very near future to adopt an

means by which the capacity of the second locomotive could be utilized. The plan developed was the application of a main reservoir line to each locomotive by which the pumps and main reservoirs of each locomotive could be coupled together, thus increasing the capacity directly in proportion to the number of locomotives coupled. Increasing the pump and main reservoir capacity was not feasible because:

First.—The first cost was prohibitive when considering that the main reservoir line could be applied to each locomotive for about \$25.

Second.—The design of the locomotives would not permit increasing the air producing plant and storage without seriously interfering with other apparatus and materially discommoding the making of running repairs to the locomotive.

Third.—To apply a second No. 5 pump to the locomotives having only one No. 5 pump would immediately produce trouble as the enginemen would show a preference for these locomotives.

Fourth.—As none of the freight locomotives have superheaters it appears to be inviting steam failures to increase the steam consumption by applying another pump, especially on locomotives that were not free steamers.

Fifth.—The air compressing plant on the second locomotive would still be idle.

The application of a main reservoir line appeared to present one very serious difficulty—the loosening of the main reservoir pressure should a hose burst. But investigation shows that this is more of a prejudice than an actual danger, as many passenger trains are operating with a 110 lb. train line pressure with the M. C. B. standard air hose between

Sixth.—Should the compressor fail on the leading locomotive it prevents having to change the second locomotive to the lead. The lead engineman has the use of the compressors on the second and any other locomotives coupled in on the head end of the train just the same as though they were on his own locomotive.

Seventh.—It gives the engineman much more confidence in his ability to handle the train successfully and increases his efficiency accordingly.

The method of piping followed in using this main reservoir line is shown in the illustration, a 1 $\frac{1}{4}$ -in. pipe being used. These lines are tapped into the main reservoir and extend to the forward end of the locomotive and to the rear of the tender on the left side. The air hose and angle cocks of these lines are painted red to indicate that they carry main reservoir pressure and to prevent the accidental coupling of them to the train line.

The special instructions issued by the road to those handling the locomotives equipped with the main reservoir line, cover the handling of the angle cocks when the engine is and is not being used with other locomotives. The men are cautioned against tampering with the governors, thus increasing the main reservoir pressure and particular attention is called to the necessity of frequently examining the main reservoir line hose for leaks or signs of distress, in order to prevent any failure in service. The instructions for coupling up the main reservoir line are as follows:

“When the main reservoir line hose have been coupled, the main reservoir pressure on both the lead and second locomotives must register the same before the angle cocks of

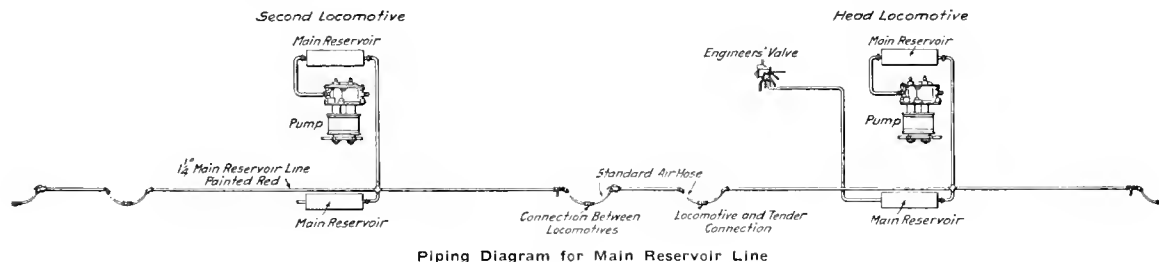

the cars. The M. C. B. standard air hose specifications require a 500 lb. hydraulic test pressure for a certain length of time without developing leaks or defects which convinced us that there was little likelihood of a failure from this source, although it was guarded against in the instructions as shown further on. As a matter of information we use the New York B3 HP locomotive equipment with the independent straight air valve and carry 90 or 110 lb. main reservoir pressure. The source of loosening the main reservoir pressure due to breaking off a pipe has always been present on a locomotive and has frequently occurred without any serious results, especially on locomotives with large pumps and main reservoir capacity.

The advantageous features developing from the use of the main reservoir line are as follows:

First.—Increasing the pump and main reservoir capacity in proportion to the number of locomotives added to the head end of the train.

Second.—It cut the time of charging trains at terminals or on the road in the same proportion.

Third.—It decreases the tendency of the brakes to drag and practically prevents breaks-in-two from the brakes not releasing promptly on the rear end.

Fourth.—It divides the service of the compressors cutting down the chances for compressor failures and decreases the wear and tear on the compressors.

Fifth.—It equalizes the steam consumption of the compressors tending to help a poor steaming locomotive.

the main reservoir line are opened between the locomotives. In other words, the main reservoir line pressure on both locomotives must be either zero, 90 lb., or 100 lb., and not zero on one locomotive and 90 lb. on the other; or 90 lb. on one locomotive and 110 lb. on the other.

“After the main reservoir line pressure on both locomotives register alike, one main reservoir line angle cock must be opened slowly to charge the air hose between the locomotives to main reservoir pressure and to prevent rupturing the hose; then the other angle cock opened.

“Before the main reservoir line is coupled up, the angle cock cutting out the brake valve on the second locomotive must be closed to prevent the second locomotive feeding the train line. The train line will be supplied and reduced by the engineman on the lead locomotive exclusively.”

The instructions covering the tests to be made on the main reservoir line are as follows:

“At shops or other points where the air on locomotives is tested, the main reservoir and train lines of two or more locomotives should be coupled up and each locomotive tested separately by cutting out the engineman’s brake valve on all the locomotives except the locomotive under test. The test should be made the same as if a single locomotive were being tested, but care should be exercised to observe that the brakes apply and release correctly, and that all the pumps are operating properly without shutting down before the proper main reservoir pressure is reached and maintained on all the locomotives.”

GAR DEPARTMENT

STRENGTHENING WOODEN FURNITURE CARS

In the strengthening and rebuilding of wooden furniture cars the Illinois Central has developed some interesting methods that have served their purpose admirably. The cars



Fig. 1—Distorted Running Board Due to Weakened Construction

were more or less old and range in outside length from 40 ft. 10 $\frac{5}{8}$ in. to 50 ft. 10 $\frac{5}{8}$ in. Being of wooden construction and of considerable length for such cars it was

found that the severe service to which freight cars are now subjected distorted them to the condition shown in Fig. 1. The cars being in otherwise good condition, a well developed plan of reinforcement was adopted.

The underframe was strengthened by the addition of two 8-in., 21 $\frac{1}{4}$ -lb. channel draft sills, with a $\frac{1}{4}$ -in. cover plate, extending for the full length of the cars. These sills were applied between the existing wooden center sills as shown in Fig. 2. The body bolsters and all other parts of the old equipment were retained. The needle beams were reinforced by 2 $\frac{1}{2}$ -in. by 2 $\frac{1}{2}$ -in. by $\frac{3}{8}$ -in. angles applied at the top, directly below the sills. In addition to this, diagonal braces were applied in the form of angles which extend from the ends of the needle beams back to the draft sills at the body bolsters. The floor was also strengthened by using 2 $\frac{1}{4}$ -in. flooring instead of 1 $\frac{3}{4}$ -in.

The sides and ends were strengthened by replacing the side posts with other posts 1 $\frac{3}{4}$ in. thicker. This necessitated bringing the posts outside the sheathing and this was done by rabbetting the post for $\frac{1}{2}$ in. on each side from the outside for the siding. This is clearly shown in section Y-Y in the end view shown in Fig. 3. This was supplemented by the addition of a $\frac{3}{4}$ -in. tie rod at each post extending through the sills and plates. The ends were reinforced further by diagonal strap braces 3 in. by $\frac{3}{8}$ in., extending from

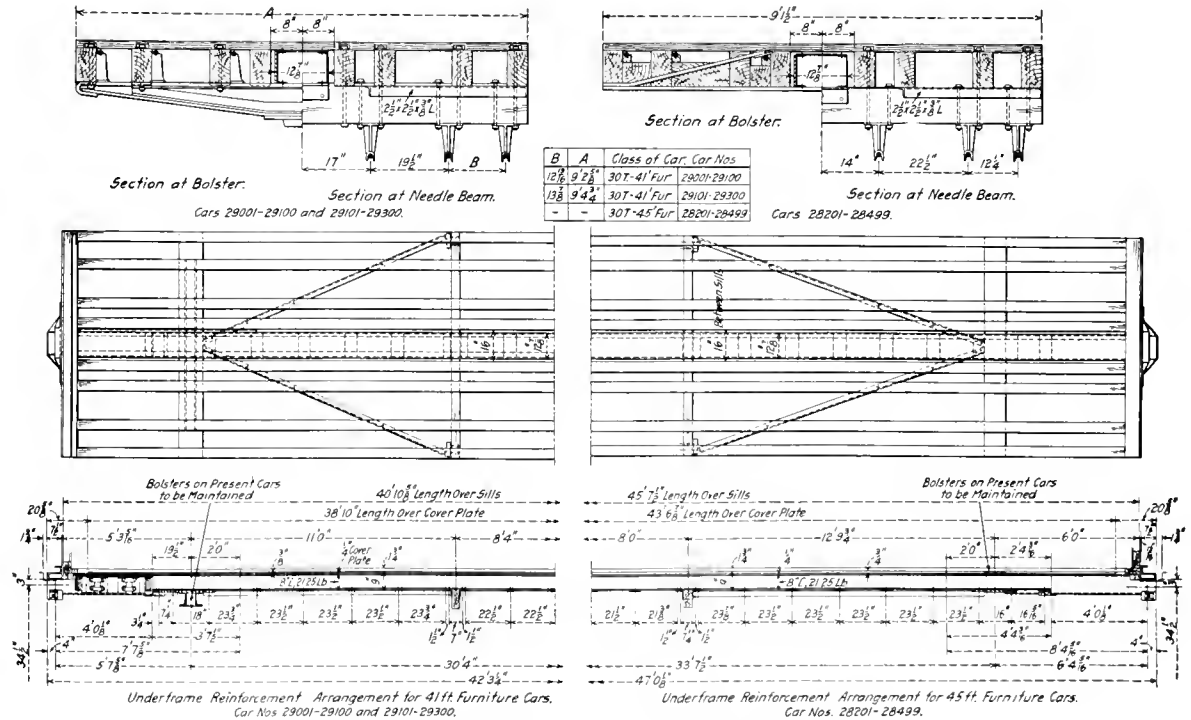

Fig. 2—Underframe Reinforcement for Long Wooden Furniture Cars

FRENCH BOX CARS BUILT IN AMERICA

Description of 24,800-lb. Capacity Box Cars Built for Du Nord and Paris, Lyons & Mediterranean

ON account of the war a large amount of railway equipment has been built in America. The freight cars built for the French railways have many interesting features in their construction. There were 4,000 built for the Paris, Lyons & Mediterranean and 1,300 for the Chemin de Fere du Nord. These cars were built by the National Steel Car Company, Ltd., Hamilton, Ontario.

P. L. & M. FREIGHT CARS

The cars built for the Paris, Lyons & Mediterranean were standard equipment, being well adapted to general service. They are sufficiently well ventilated for hauling cattle, horses or men and are equally as well equipped for hauling loose or sacked grains, baled hay, munitions and almost any other kind of miscellaneous military equipment. They are shown

extend between the pedestal sills and to which they are connected by rolled steel angle connections and top gusset plates of flat steel. Underneath these gussets and riveted to them and to the cross sills and the pedestal sills, are cast steel brackets for the suspension spring.

The draft sills, or draft gear guides consist of four 2 $\frac{3}{8}$ -in. by 2 $\frac{3}{8}$ -in. by 5/16-in. rolled steel angles at each end of the car extending between and passing to the end sill and cross sill nearest the end of the car. The top draft sills are riveted permanently to the end and cross sills, but the bottom ones are bolted in place and can be taken down for the removal of the draft gear. Between the draft sills at each end of the car is a steel casting, the back end of which is bolted to the cross sill and serves as a stop for the draft spring when the buffers are under compression. A single

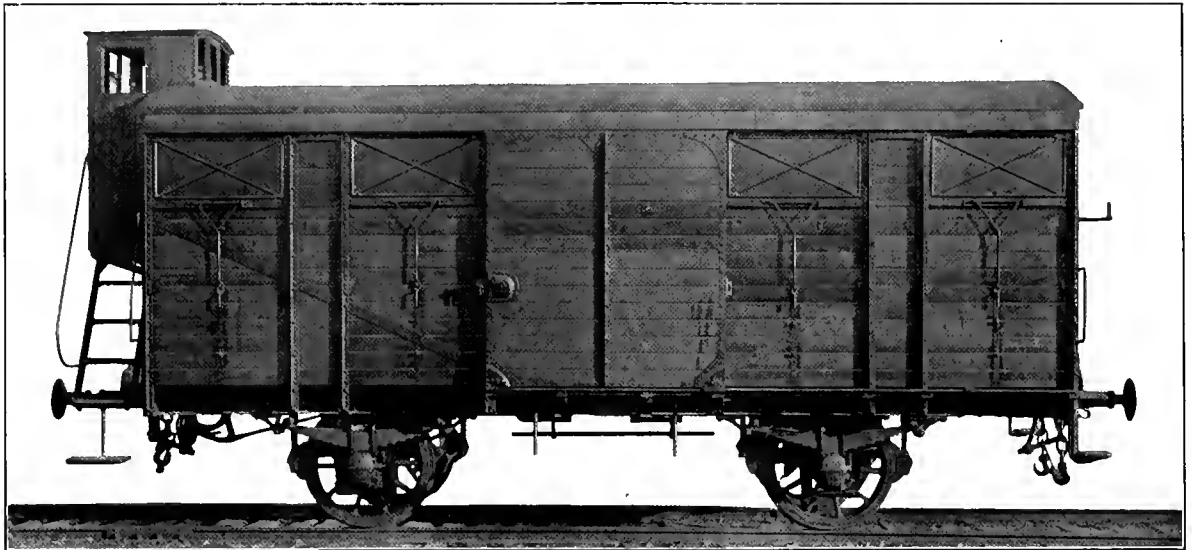

Fig. 1.—Box Cars Built for the Paris, Lyons & Mediterranean With Brakeman's Box or Guerite

in Figs. 1 and 2. The principal dimensions of these cars are as follows:

Gage	4 ft. 8 $\frac{1}{2}$ in.
Length over end sills	23 ft. 9 $\frac{7}{8}$ in.
Wheel base	12 ft. 3 $\frac{5}{8}$ in.
Length inside	23 ft. 7 $\frac{1}{2}$ in.
Height from rail to top of floor	4 ft. 5 $\frac{1}{2}$ in.
Height from rail over body roof	12 ft. 2 $\frac{1}{4}$ in.
Height from rail over guerite roof	13 ft. 0 $\frac{1}{2}$ in.
Width of car body inside	8 ft. 7 $\frac{1}{2}$ in.
Width over floor at door opening	9 ft. 1 $\frac{3}{8}$ in.
Width of door opening	5 ft. 6 $\frac{3}{4}$ in.
Approximate weight of car	24,500 lb.

Underframe.—The underframe of these cars is of all-steel construction, all sills being made of rolled steel shape. The pedestals for the wheels are sheared from steel plate 2 $\frac{3}{32}$ in. thick. These are riveted directly to the pedestal sills. These sills are 10 in., 21.8 lb. rolled steel ship channels, extending the full length of the car between end sills to which they are connected by rolled steel angle corner connections and top and bottom cover plates. The end sills are of the same rolled section as the pedestal sills and extend across the car past the pedestal sills to the side sill line, where they support the side sills and corner posts. There are four cross sills per car, of 7-in., 12.25-lb. rolled steel channels which

7-in., 15-lb. rolled steel I-beam forms the center sill and extends between the cross sills through the three intermediate spaces. They are connected to the cross sills by rolled steel angle connections and flat plate top gussets. On the center and draft sills and extending the full length of the underframe is bolted an oak nailing strip for the floor.

One large semi-elliptic spring extends almost entirely across the underframe at each end and serves both for the buffers and draft gear. These springs are supported by and slide between the draft sills, and the center spring band is a drop forging with a jaw at the front in which the forged draw hook anchors or pivots. Heavy forged buffers of the mushroom type are mounted in cast steel guides near each end of the end sills and their long forged stems extend through the end sills and cast steel inner guide and terminate in cast iron brackets fitting over the ends of the draft springs. When the draw hooks are pulled forward the inner guides for buffer stems act as stops for the ends of the springs; and when the buffers are compressed, the steel castings mentioned above act as stops behind centers of springs.

The side sills from the door opening to the ends of the car are of 3 $\frac{1}{4}$ -in. by 2-in. by 5, 16-in. rolled steel angles and

those across the door openings are of the same section with short legs sheared to $1\frac{5}{8}$ inches. The side sills are supported at the ends by the end sills to which they are riveted

Running Gear.—Two thousand cars are equipped with solid forged steel wheels, 40 9 16 inches in diameter, and two thousand with steel-tired wheels, having cast steel cen-

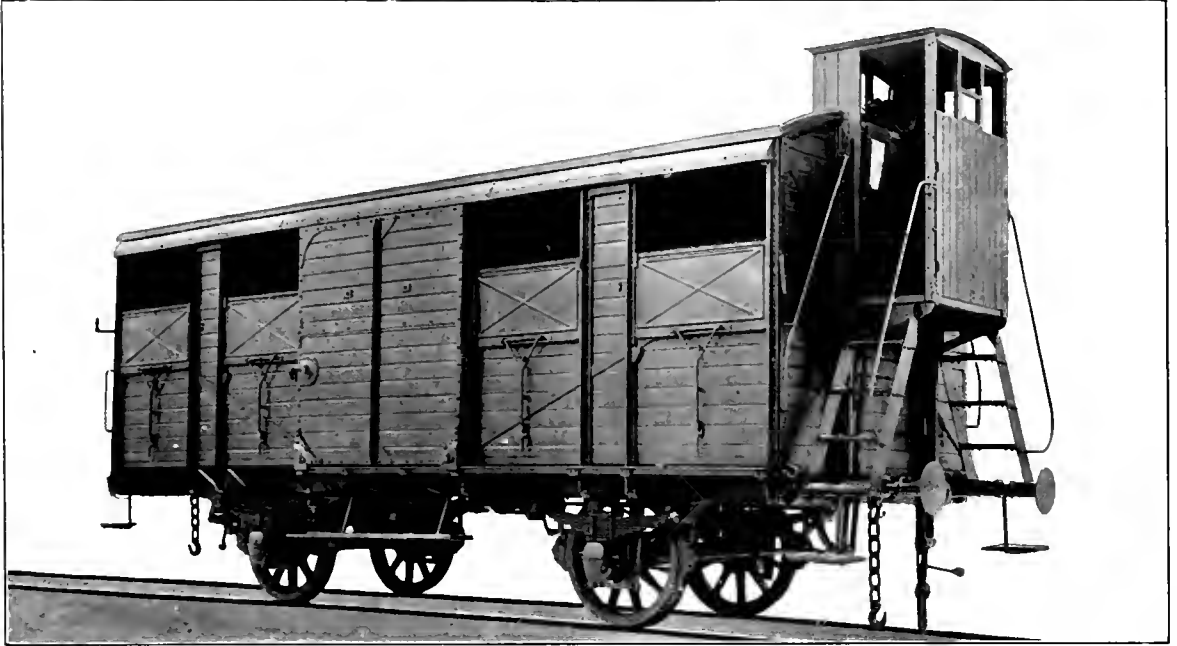

Fig. 2—View of the P. L. & M. Box Car, Showing Dropdoors in the Sides Open

and at intermediate points by braces of flat steel bars extending to the pedestal sills. The floor of the car is made of $1\frac{3}{8}$ inches thick, yellow pine or oak boards with 3 16-in. cracks

ters. The built-up wheels have tires $2\frac{1}{8}$ inches thick and steel retaining rings. The axles are of forged steel, rough-turned and annealed. The journals are $5\frac{1}{8}$ in. by $10\frac{1}{4}$ in.

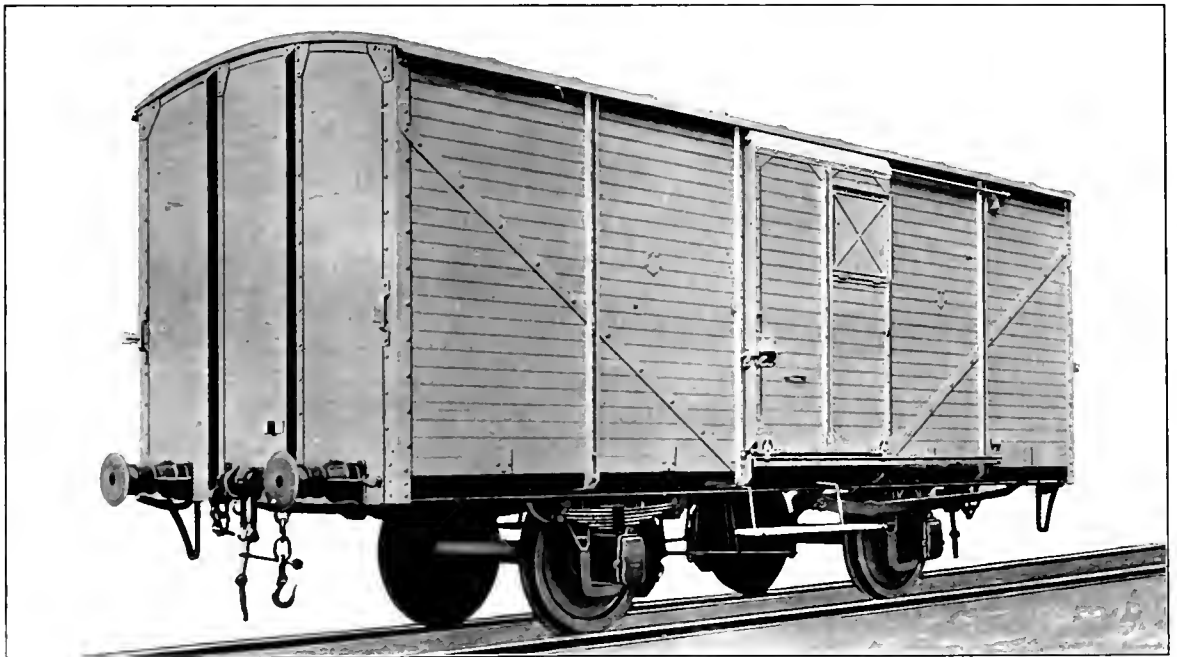

Fig. 3—Box Car of the Plain Type for Du Nord Railway

between, except over the draft gears at each end where ingot iron tongue strips are inserted.

The journal boxes are of malleable iron, being cast in two iron tongue strips are inserted.

There are no journal bearing wedges, but the solid brass bearing fits the inside contour of the top of the box. The dust guards are in two pieces, being parted on the horizontal center line of the axle and having springs at the top and bottom which keep the joints closed. The dust guards are made of two thicknesses of heavy sole leather with canvass between and the edges bound in sheet steel. Oil is poured into the boxes through spots cast on the lower halves and is fed to the journals through large wicks. The suspension springs are of the semi-elliptic type seated on the journal boxes and connecting to cast steel brackets on the pedestal sills by pins and forged links.

Brakes.—The car is equipped with clasp brakes, cast iron shoes and National Steel Car Company's patented trussed beams. The brakes are operated from the guerite by a vertical hand wheel, which is bevel geared to the vertical screw shaft. The screw shaft nut is connected through forged links to a bell crank just under the end sill, and this bell crank actuates the main brake connecting rod.

The total pressure on the brake shoes with a stated force

bers. The upper door guide on the door is a 2-in. by 1½-in. by 5/16-in. rolled steel angle extending the full width of the door and riveted to the top of the door frame. The above guide slides between two rolled steel angles, which are supported on cast steel brackets on the side of the car.

The door is fastened by an outside drop forged hook which drops into a cast steel keeper in the door post. The hook can also be operated from the inside by a cast iron handle. The door is stopped at the back by a malleable hook which wedges into a stop on the door post and forces the door close in toward the body of the car. The shutters are of pressed steel, sliding in grooves on side posts, and they are operated by pivoted handles which drop down within reach of the operator when standing on the ground. The height of the shutter can be regulated by three forged pegs in the side washer plates which fit in a slot in the shutter handle.

The side door posts are 3-in. by 3-in. by 3/8-in. rolled steel angles and the intermediate side posts are 3-in. by 2½-in. by 5/16-in. steel tees. The corner posts are made up of one 3-in. by 2½-in. by 5/16-in. tee and one 2½-in. by 1¾-in. by

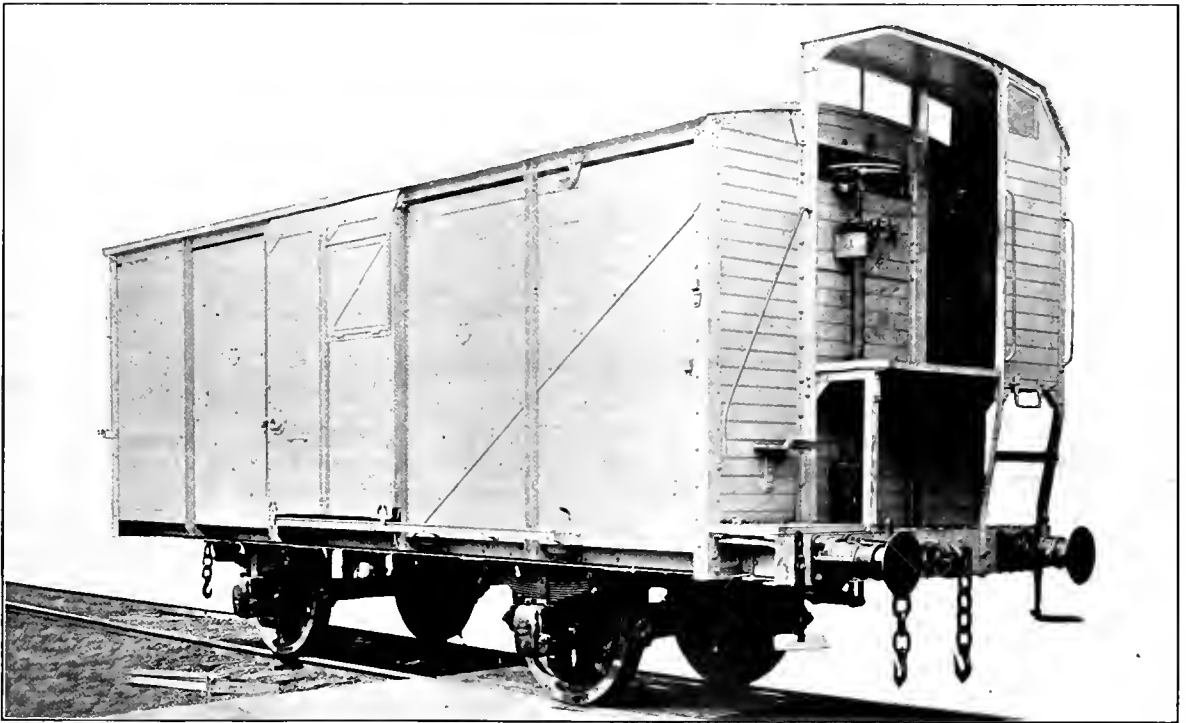

Fig. 4—Du Nord Railway Box Car With the Guerite

applied at the brake wheel must equal 70 per cent. of the loaded weight of the car. This is very greatly in excess of braking power as applied on cars in America, which is calculated on the basis of the light weight of the car.

Side and End Framing.—Each side of the car has one sliding door mounted on bottom rollers with a rolled steel angle track and four shutters. The door frames are of 2¼-in. by 1¾-in. rolled steel angles welded in the corners. The outside flange of the angle is exposed with wood sheathing fitted to the inside of the frame. A vertical tee of 3-in. by 2½-in. by 6.1-lb. rolled steel section forms a center brace on the outside of the door, and all corners are securely tied with flat steel gussets. The bottom corner gussets are pressed to form the outside half of the roller sheave and track guide. Horizontally across the center of the door frame and on the outside is riveted a flat steel bar which ties the side mem-

5/16-in. angle on the outside at each corner and one 2¼-in. by 1½-in. by 3/16-in. rolled angle on the inside of the sheathing. Side diagonal braces of 3½-in. by 5/16-in. steel plates run from the foot of the door posts to join the corner posts just below the bottom of the shutter openings. The side plates are 2½-in. by 1¾-in. by 5/16-in. rolled steel angles extending the full length of the car and are gusseted to the end plates and steel carlines. They are reinforced above the door with 5/16-in. by 57.8-in. plate. The end plates are of the same section as the side plates. The end posts are deformed I-beams, which extend from the bottom of the end sills to the steel end plates. The spacing of the end posts of the guerite end of the car is wider than at the plain end, and to them is riveted the pressed steel cantilever which supports the guerite frame. Two end diagonals of 3½-in. by 5/16-in. flat steel bars cross at each end of the car

on the outside of the sheathing. The feet of these diagonals are blanked out of plates and welded to the bars, being illustrative of standards of work on European freight cars. The side and end boards are ship lapped fir. The thickness of the boards for a distance of $37\frac{1}{2}$ in. above the floor line is 1 3/16 in.; above that point they are 7/8 in. thick.

Roof.—Tongued and grooved roof boards 9/16 in. thick are screwed directly to the wood carlines and end plates. Four of the wood carlines bolt to steel carlines formed by bending 2-in. by 1 1/2-in. by 1/4-in. rolled steel angles. The wooden end plates rest on and bolt to the steel end plates. On top of and bolted to the rolled angle side plate is a yellow pine side plate of substantial section, into which is dove-tailed the ends of all wooden carlines. This side plate is under-cut for the full length to receive the top edge of a door hood or eave strip of No. 16 galvanized steel about 8 in. wide. This forms an effective roof projection across door and shutter openings.

Guerite.—The construction of this cab is most elaborate and expensive, and it is hard for Americans to see the necessity for any such quarters for a brakeman. The guerite is framed of oak with tongued and grooved sheathing, drop sash in front and hinged sash in the rear just over the body roof, glazed doors and upholstered seats. There are two pivoted seats to each guerite and they are counter balanced with heavy castings which swing the seats up and out of the way when unoccupied. All of the framing, sashes and doors are mortised and tenoned and glued together. Steel framed stairs with forged hand rails on either side afford access to the guerite.

NORD RAILWAY OF FRANCE CARS

During the winter of 1915 and 1916 the same company built 1,300 four-wheel, steel frame freight cars of the same capacity and of similar size for the British War Office for use in France. The cars were built to the du Nord Railway of France drawings. Twelve hundred of these cars were of the plain type, as shown in Fig. 3, and the remaining hundred were equipped with the guerite, or brakeman's box, as shown in Fig. 4.

The cars shown in Fig. 3 are equipped with foot lever brakes located at diagonally opposite sides and breaking on two wheels per car. The guerite type cars are equipped with a screw brake and brake beam very similar to American railroad practice. In service a train is made up of one car of the guerite type to ten or twelve of the plain cars. The brake on the guerite type of car is of the screw type and very powerful. It is designed to exert a force through the brake shoes on the wheels of approximately 70 per cent of the gross weight of the car, that is, including the load. The foot levers on the plain type of cars are seldom used on the road. They are used mostly in the yards. This brake will be noticed in the lower left hand corner of Fig. 3, and it is applied by the brakeman running alongside of the car and dropping the foot lever from its safety catch. To apply the brake, the brakeman stands on the end of this lever, which projects beyond the end of the car.

There is a ratchet device very similar to that used in American practice, used on the screw brake of the guerite type of car. It has a helical spring applied to the brake mast, the function of which is to unwind the brake automatically upon the release of the ratchet. This ratchet dog is usually operated from the brakemen's cab, but it is also arranged to be released from the inside of the car by a conductor's cord, extending through the end of the car and attached to the dog.

The superstructure of these cars consists of a steel frame with 1-in. tongue and groove single lining. The cleats shown on the side of the car in Fig. 3, are riveted to the side sill midway between each side post to prevent the bottom post from bulging when carrying grain, etc. The small plate in the center of the panel on either side of the side doors is provided to secure a staple for hitching cattle when the cars are used in such service.

The roof of these cars is made up of angle carlines covered with roof board, on the top of which are applied flat galvanized steel roof sheets running crosswise of the car and butting over the center of each angle carline. This joint is laid in thick lead paint, on top of which is applied the wooden roof cleats, which are securely bolted through the roof board to the carlines. The underframe is of all-steel construction.

The material on these cars conforms to the best American railroad practice, the British War Department having specified, in nearly all cases, the Canadian Pacific Railway's standard material specifications. The inspection of the work during the process of manufacture was carried on by the Grand Trunk Railway System. These cars were shipped from the works of the National Steel Car Company knocked down and were erected in France. They were painted with colors suitable to produce a khaki effect when the final coat was applied "somewhere in France."

DRAFT ARM OF ROLLED STEEL

More than a year ago the E. J. & E. designed a draft arm made of plate and structural shapes for reinforcing some of the company's wooden box cars of 80,000 lb. capacity. A large number of these draft arms have been constructed at the company's shops at Joliet and applied to cars as they came in for repairs. In the design care was taken to provide ample sectional area over the bolster and extreme stiffness between the bolster and the draft gear.

The section extending over the bolster is made of a 1/2-in. steel plate 26 in. wide at the bolster and tapering behind the draft lugs to a width of 19 in. Two 8-in., 16-lb. channels are riveted to this plate, with the flanges turned outward. The draft lug castings, for double spring gear are riveted to the backs of the channels. Behind the lug

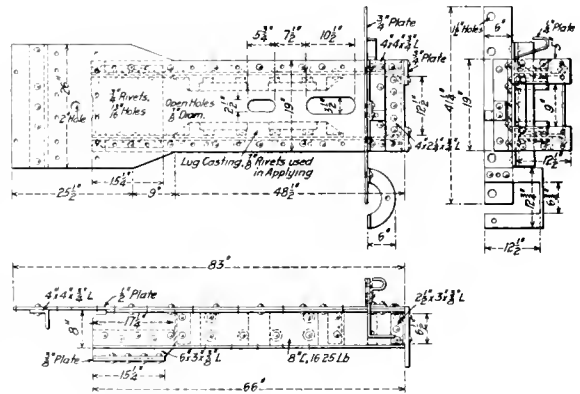

Rolled Steel Draft Arm for the E. J. & E.

castings the channels are reinforced with 6-in. by 3-in. by 3/8-in. angles riveted to the inside faces, with the flanges extending outwardly. The angles are connected by a 3/8-in. plate riveted to the bottom flanges which stiffens the member at this point and also keeps the channels from spreading.

A 4-in. by 4-in. by 3/4-in. channel is riveted to the upper side of the draft plate outside the end sill and carries a 3/4-in. by 6-in. plate extending across the end sill. Four of the truss rods pass through this plate. Across the end of the channels is fastened a 4-in. by 2 1/4-in. by 3/4-in. angle with the longer leg horizontal which acts as a striking block. A short section of 2 1/2-in. by 3-in. by 3/8-in. angles is riveted to the end of each channel between the flanges and 3/4-in. by 5-in. plates are riveted to these angles to support the carrier iron.

SAFE LIFE OF AIR BRAKE HOSE*

There are many angles to the question of the safe life of an air brake hose, but, generally speaking, the life is what we make it. From our researches we are led to the belief that the greater portion of air hose failures is due to the destructive practice of pulling them apart, "cornering" cars while switching, couplers passing, etc. While all railroad companies have in their standard code of rules one prohibiting the pulling apart of air hose, this rule is not generally enforced, and hose are therefore subjected to abuses which shorten their life materially. In order to determine the average safe life of an air hose in actual service; or, in other words, the time that should be allowed to elapse after hose are put into service before they are removed thereby anticipating possible hose failures, inspections and records were made of a total number of 2,500 hose that were removed on account of being burst, and also inspections of 5,000 hose which were still in service. As there is such variation evidenced in the number of months' average service as between various groups of hose examined, the record of the burst hose is given in the several groups in which the examinations were made.

Number of Hose Examined.	Total Number Months in Service.	Average Life of Each Hose in Months.
446	13,333	29.8
79	2,075	27.3
370	11,358	30.4
28	694	24.4
6	426	71.0
63	2,025	32.1
61	1,812	29.7
393	11,842	30.1
528	13,728	26.0
49	582	32.0
25	994	36.0
17	459	27.0
2	213	106.0
100	2,550	25.5
100	2,725	27.25
100	2,950	29.5
133	3,990	30.0
Total 2,500	Total 71,566	Average 28.6

The hose examined while still in service showed the following average life:

Number of Hose Examined.	Total Number Months in Service.	Average Life in Months.
200	6,500	32.5
382	5,730	15.0
470	9,644	20.5
402	7,280	17.85
55	1,765	32.1
404	8,988	22.2
500	13,800	27.6
500	11,250	22.5
500	9,615	19.2
500	7,705	15.4
100	1,955	19.5
152	2,475	16.3
100	1,730	17.3
200	5,120	25.6
200	5,644	28.2
235	4,879	20.7
100	2,361	23.6
Total 5,000	Total 106,441	Average 21.3

Study of the data in regard to burst hose shows a very wide variation in the term of service, the minimum being 24.4 months, and the maximum 106 months. This latter was for only two hose. It will be noted that in spite of the fact that some few hose gave a very long term of service, the general average life of burst hose examined was but 28.6 months.

In regard to the hose still in service which were examined and which are also shown in groups, it will be noted that the average life of the various groups, as well as the general average of the whole number, is low as compared with the average life of those burst.

A comparison of the general averages as between those burst and those in service shows that the hose examined in service should continue so for 7.3 months longer.

It is the opinion of the committee that abuses to which hose are subjected, including failure to uncouple the hose

by hand, are responsible for most of the damage that causes hose failures. In order to prove this statement 500 burst hose were examined for the purpose of recording the point of rupture. Of these, 245 or 49 per cent burst at the nipple end; 102, or 24 per cent, burst at the coupling end; 153, or 30.6 per cent, burst elsewhere in the hose body. Of the above number, 150 or 30 per cent, burst on the protected, or under side; 135, or 27 per cent burst on the front, or upper side, and 215, or 43 per cent, burst either on the gasket side or on the side in line with the back of coupling. Of the 245 hose which burst at the nipple end, 132, or 50 per cent, were bruised, or kinked as a result of being pulled apart repeatedly.

Examination was also made at one terminal of 16,272 hose which passed through in six days, and the following data was collected: In service less than two years, 11,790, or 72.5 per cent. In service two to three years, 3,433 or 21.09 per cent. In service over three years 1,049, or 6.4 per cent. The foregoing would indicate that not 50 per cent of the hose survived the two year limit and only 6 per cent survived the three year limit.

There was also a record kept in one big yard of the number of hose burst while getting out trains, and a record of the total number of cars handled was kept for the purpose of determining about what percentage of hose could be expected to burst in ordinary traffic. The record showed as follows: Total number of cars handled in thirty days, 568,000; total number of hose handled in thirty days, 568,000; number of hose burst during thirty days, 282; percentage burst of all hose handled 0.05; average life of the hose burst, 29.9 months.

We also made observation of the abuse, other than pulling apart, to which hose are subjected in switching. The record for one month made by one observer in only one terminal shows 148 hose ruined by cars "cornering" or couplers passing, which caused the hose to be broken or cut off from the brake pipe.

In the 148 cases observed, 30 angle cocks and brake pipe nipples were broken. In all cases the hose was absolutely ruined, and this before the trains were made up. When we consider that such abuses are of daily occurrence in many busy yards, the resultant damage to air hose may be imagined.

Except in comparatively new hose, less than eighteen months in service, the cover cracks gave little indication of the real condition or probable durability of the hose. That is to say, there were as many burst when slightly cracked as there were when badly cracked. The lesson to be drawn from this is that the surface cracks in the hose depend greatly on the ageing qualities of the material supplied by different manufacturers, but does not serve to give a reliable indication of the real condition of the interior fabric.

What may result from hose bursting in a moving train is problematical, but to say the least, the damage, delay, and expense usually involved would pay for the hose itself many times over. It would, therefore, seem a matter of economy to remove hose that have been in service 28 months, even though test may not show them to be porous, because the foregoing data indicates that the average hose is liable to failure at any time after that length of service. We believe that if each hose made the same car mileage in the 28 months, they would all be in such a condition that failure might be expected at any time.

Removal of air hose at the time limit mentioned would increase the number of hose purchased and, therefore, the total cost for hose; hence, any economy effected would not be apparent in the purchasing and stores account, but would be reflected in the maintenance of equipment account, and in the earning capacity of the various units of equipment.

The question might be asked: Why is the average life of hose not more than twenty-eight months? The answer is:

First: Because of the rigors of the service. This involves

* Abstract of a committee report presented at the 1917 convention of the Air Brake Association.

exposure to the elements detrimental to the materials of which the hose is constructed.

Second: Pulling hose apart instead of uncoupling by hand, "cornering" cars, etc., which has such a destructive effect on the inner lining of the hose, this lining being really the life of the hose itself.

Third, and last but not by no means least: the specifications under which some of the hose are manufactured. This is not intended as a reflection on the specifications and tests, but we have information from one of the large manufacturers that to follow specifications to the strict letter would result in a hose of inferior quality at times and the manufacturer, therefore, in order to give a reasonable term of service, must use his best judgment in modifying the specifications in certain particulars.

The hose made to specification are not guaranteed for a definite term of service, and so long as the test specimens pass the required tests, there is nothing else demanded of the manufacturer. However, the materials may not at times be those that will age the best.

Another question might be asked: What can be done to increase the life of the hose?

First: With hose of the present manufacture begin the life saving in the hose mounting room. The nipple ends should be rounded off smooth. The hose clamps used in mounting should be flexible and should not be used after they have elongated sufficiently to allow the shoulders to come together when clamping the hose. Particular care should be exercised in mounting hose to see that the lining is not damaged.

Second: Every effort should be made to stop the abuse of hose while switching and have the hose parted by hand.

Third: Hose should be purchased from manufacturers whose product gives the best general results; and in order to give an idea of how far reaching this may be, the following data of the life of a number of hose of different makes is offered.

The name of the manufacturer is unnecessary, because any air brake man or engineer of tests can in a very few days obtain the same data on his own lines. The table follows:

Manufacturer.	Number of Hose Inspected.	Average Life in Months.
1	150	28
2	150	31
3	150	32.8
4	150	22.07
5	150	35.5
6	150	26.7
7	100	21.8
8	100	28.1
9	100	34.8

All of the above were removed from service on account of bursting, and it will be seen at a glance that the different lengths of service as between the lowest and highest is about thirteen months, or about 56 per cent greater than term of service from the hose of one manufacturer than that of a certain other manufacturer. This is a question that is worthy of deep consideration when we understand that one of our foremost railroad companies purchased as many as 700,000 hose in one year.

The committee feels that we should not close the paper without bringing to your attention the possibilities of a properly made braided hose as compared to a wrapped hose, and furnishing some comparisons with reference particularly to their ability to pass the M. C. B. test, and for that reason we will give a brief resume of the requirements of the tests and the ability of the braided hose to pass it.

Tensile Test.—This test cannot be satisfactorily made owing to the practical impossibility of detaching tube and cover from hose body.

Stretching Test.—This test cannot be satisfactorily made. The stocks would pass the 1913 M. C. B. Specifications but it is impossible to detach tube and cover in condition to give proper test specimen.

Porosity Test.—Test showed porosity practically nil. Hose practically all rubber in one homogeneous mass. Absorption test showed that hose totally immersed in water for one week absorbed 0.8 per cent moisture only.

Bursting Test.—Average bursting pressure 1,400 lb. Expansion at 1,000 lb. pressure 3/16 in. in circumference. Elongation practically nil. Special abrasion resisting cover used of tensile strength about the same as 1913 M. C. B. Specification. There can be no ply separation in this hose.

Friction Test.—Test cannot be made satisfactorily on account of the practical impossibility of detaching tube from cover.

Reference to the foregoing will show that the braided hose was able to pass every test to which it could be subjected, and as the price of braided hose was only slightly greater than that of wrapped hose, at the time the test was made, the braided hose should be tested out in actual service, and the matter of using it instead of wrapped hose is one well worthy of consideration.

We were not able to obtain any reliable data to show whether the burst hose examined was removed from passenger or freight equipment. However, hose in passenger service cannot be expected to last much, if any, longer, than those in freight service, for while they are not usually subjected to such rough treatment as are the freight hose, they are generally operated with higher pressures, and make so much more mileage than do freight car hose that in the ordinary course of events they could not be expected to outlive the latter.

It is a noteworthy fact that comparatively few of the hose inspected were removed on account of being porous, which indicates that this feature of hose failure is not receiving the attention it should, and your committee believes that if more testing with soapsuds was done on the repair tracks, considerable economy would result by the removal of porous hose, because they are responsible for much of the delay occasioned in getting out trains and for much of the damage incurred while braking moving trains.

The trouble experienced and damage resulting from trying to handle the brakes on leaky trains is so well known to all here present that comment is unnecessary.

The committee hopes the matter will prove sufficiently interesting so that all concerned will make a campaign to increase the life of the air hose.

The report was signed by M. E. Hamilton, chairman; Jos. W. Walker, M. S. Belk and George W. Noland.

DISCUSSION

The stresses in the hose when they are allowed to uncouple are quite high, especially with hose couplings which do not conform to the standard custom. The practice of uncoupling by hand has caused a marked reduction in the consumption of hose. Removing hose at regular intervals and testing with soapsuds when cars are on repair tracks resulted in eliminating failures. The use of hose protectors is not advisable but hose should be mounted carefully. It was suggested that it might be well to change the angle at which hose are hung so that they will be bent less when coupled.

The association voted to recommend to the M. C. B. Association that a rule be provided that air brake hose, as at present manufactured, be removed 30 months after date of manufacture.

BRITISH STEEL IMPORTS.—The extent to which Great Britain has been increasing her output of steel products is reflected in the February, 1917, statistics of steel imports. The imports of iron and steel amounted to 27,428 tons as compared with 76,125 tons in February, 1916, and a monthly average for the year of 72,740 tons. Iron ore imports were considerably greater than for the same month a year ago, the amount being 507,560 tons this year and 403,973 tons last year.

SIDE BEARING LOCATION*

BY LEWIS K. SILLCOX
Mechanical Engineer, Illinois Central

One of the refinements in the design of the average freight truck which seems to seldom receive definite attention and from the tendency of practice followed in certain sections of the country, it would appear as being entirely misunderstood, is the matter of the proper location of side bearings. The real truth of the matter has been forced on some roads through their experience with the derailment of locomotive tenders and it is made a live issue in this class of equipment principally because there is more liability for obtaining a higher center of gravity than is possible in the case of the

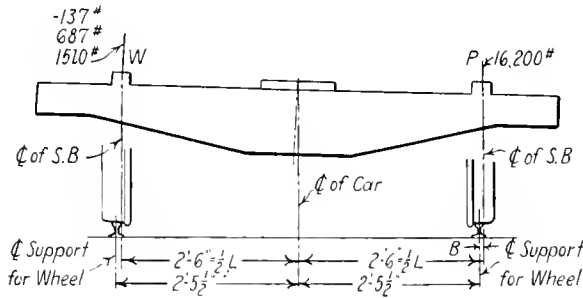

Fig. 1

usual freight car; the high center of gravity causing a great tendency for the equipment to roll dangerously. There is, generally speaking, only one remedy for such cases and that is to decrease the distance between the centers of the side bearings and this has been successful in eliminating the difficulty mentioned in most cases.

Deraillments occurring in the case of freight equipment cars are so few considering the total number of cars handled that we are often led to believe that the location of the side bearings has nothing to do with the case. The raised outer rail of curved track is illustrative of track out of line, especially with respect to slow moving equipment. The same conditions may prevail at any point where the relative ele-

acts vertically to prevent the wheel climbing the rail. This resultant is influenced very materially by the distance from center to center of the side bearings. In order to appreciate this, we will consider the centers of the side bearings directly over the centers of the rails. In the case of a curve where the outer rail is elevated the inner side bearing is thrown over towards the outside of the rail. But this inner bearing is carrying the load and with its center approaching a point outside of the rail, it naturally follows that none of the weight of the car body is carried by the opposite wheels and therefore, no assistance is rendered these wheels in bringing them to bear on the rail. Fig. 1 shows this condition.

Assuming W' equal to the weight on the left side bearing, P (16,200 lb.) equal to the weight on the right side bearing, B , the distance between the center line of the right side bearing and the point of bearing of the wheel on the rail, and L equal to the distance between the center lines of the rails, we have, under the above conditions, the following:

$$\frac{W}{P} = \frac{B}{L} \text{ or } \frac{W}{16,200} = \frac{0.5}{59} \text{ or } W = 135 \text{ lb.}$$

Now if the side bearings were spaced 54 in. center to center B would equal $29.5 - 27. = 2.5$ and

$$\frac{W}{P} = \frac{B}{L} \text{ or } \frac{W}{16,200} = \frac{2.5}{59} \text{ or } W = 687 \text{ lb.}$$

Still again with side bearing 48 in. apart B would be $29.5 - 24 = 5.5$ and

$$\frac{W}{P} = \frac{B}{L} \text{ or } \frac{W}{16,200} = \frac{5.5}{59} \text{ or } W = 1510 \text{ lb.}$$

From the above, it is evident that in order to obtain any

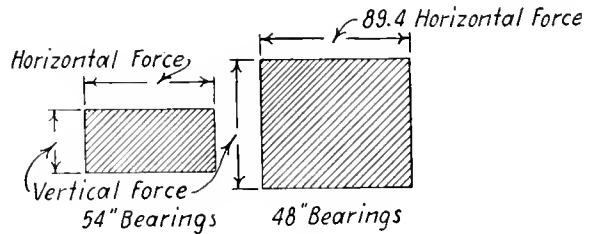

Fig. 3

pressure on the guiding wheel in the case of cars engaging curves with elevated rails, or rough track where the surface of the rails is not uniform, it is first necessary to have the working position of the side bearing inside the line of support or rail.

In order to obtain a practical idea of the problem under discussion a 40-ton car was selected and weighed on a section of scale track having a 2-in. elevation, this height being considered as representing the full compression of the springs with the initial side bearing clearance added; thus throwing the load off the center and entirely on the side bearing. The results obtained were as follows:

With side bearings spaced 60 in. center to center the weight registered was 3,100 lb. With side bearings spaced 48 in. center to center the load registered on scales was approximately 5,000 lb.

The light weight of the car was 45,000 lb. with trucks registering 6,300 lb. each and the car body 32,400 lb. Being a car of rigid construction, it was possible for the diagonally opposite side bearings to carry the entire load, 16,200 lb. going to each. The difference in the amount of weight transfer, as between the car with 60 in. and 48 in. spread of side bearings, amounted to:

$$5,000 \text{ lb.} - 3,100 \text{ lb.} = 1,900 \text{ lb., or } \frac{1,900}{16,200} = 12 \text{ per cent.}$$

When the car is standing normally on level track, we should expect to carry the total light weight of the body on

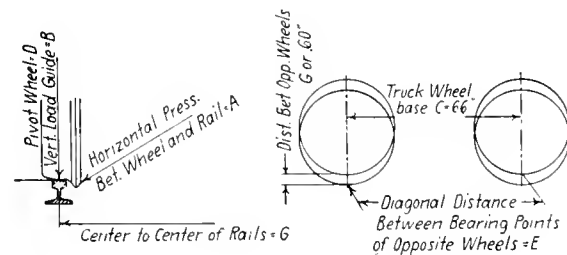

Fig. 2

vation of the rails is not uniform, because of soft spots in the track or improper ballasting.

The discussion of conditions, so far, brings up the study of the subject with respect to how far it is possible to transfer the loading to one side of the truck and still not reach the danger point, there not being enough load on the opposite side to hold the forward wheel to the rail when negotiating a curve, the forward wheel acting as a guiding element for the whole truck.

The load placed upon the guiding wheel to hold it down is in proportion to the total load carried by the wheel, which

* From a paper presented before the Car Foremen's Association of Chicago.

the truck center plates and there is a distance of approximately 30 in. from the middle of the center plate to the center of the rail or support. At a distance 6 in. in along the bolster from the side bearing it was possible to transfer 12 per cent of the total load to the other wheel, or 2 per cent for every inch the side bearing was moved in toward the center. This rate of increase would probably be steadily maintained until the large bearing of the center plate equalized the loading, as in most cases it acts for a distance of about 5 in. all around the center.

Referring to Fig. 2 the following is assumed:

- A = Horizontal pressure between the wheel and the rail.
- B = Vertical load of the wheel on the rail.
- C = Wheel base = 66 in.
- D = Weight on pivot wheel.
- E = Distance between the bearing points of diagonally opposite wheels on the rails = 89.4 in.
- F = Adhesion between wheel and rail = 21 per cent of the load.
- G = Center to center of rails = 4 ft. 8½ in. + ½ in. + 3 in. = 60 in.

As stated above there is no transfer of load from the inside bearing to the outside bearing when the bearings are 60 in. apart and that there is 2 per cent of the load transferred for every inch the side bearings are moved towards the center. With a car weighing (light) 45,000 lb., of which 12,600 lb. is the weight of the trucks and 32,400 lb. the weight of the body, we have for 54-in. side bearing spread

$$\frac{32,400}{2} \times .06 = 972 \text{ lb.}$$

of the weight of the car body going to the guiding wheels. For the 48-in. spread of side bearings we have

$$\frac{32,400}{2} \times .12 = 1,944 \text{ lb.}$$

of the weight of the car body going to the guiding wheels. This is based on results obtained from the actual tests mentioned above. Therefore, the weight on the pivot wheel D (Fig. 2) for the 60-in spread of side bearings* is

$$\frac{45,000}{2} \div 2 = 11,250 \text{ lb.}$$

For the 54-in. spread of side bearing spread this weight will be

$$11,250 - 972 = 10,278 \text{ lb.}$$

and for the 48-in. side bearing spread this weight will be

$$11,250 - 1,944 = 9,306 \text{ lb.}$$

The horizontal force acting at the guiding wheel with the 54-in. spacing is equal to:

$$F \left(B + \frac{(D \times C) + (B \times G)}{E} \right) = 0.21$$

$$\left(972 + \frac{(10,278 \times 66) + (972 \times 60)}{89.4} \right) = 1,935 \text{ lb.}$$

The horizontal force acting at the guiding wheel with the 54-in. spacing is equal to:

$$0.21 \left(1,944 + \frac{(9,306 \times 66) + (1,944 \times 60)}{89.4} \right) = 2,125 \text{ lb.}$$

The graphical chart (Fig. 3) shows how the forces were practically balanced with a spacing of 48 in. in centers.

From the above comparison, it may be noted that by moving the side bearing only 3 in. in on each side of the car here considered (i. e. 54-in. to 48-in. centers) it is possible practically to equalize the vertical and horizontal forces.

The preceding figures have simply dealt with the light car body and trucks without load. As the vertical forces increase, it will be noted that a tendency prevails to accentuate the horizontal forces acting between the rail and the wheel flange, causing them to be more severe. As long as the capacity of the springs is not exceeded, they will prevent the side bearings from carrying the total load, a considerable proportion will be carried by the center plate and consequently distributed to the wheels on the far side of the truck. The great tendency, however, for most loaded cars, especially

those having a high center of gravity, is to lurch towards the inner side of the curve, or the side where a low spot in the track occurs, and unless the forces acting at the side bearings are so applied as to prevent the guiding wheel from being relieved of sufficient loading to allow it to nose over the rail, great risk of derailment obtains.

Side bearing travel can be approximately calculated as follows: Multiply the distance in feet from center to center of trucks by the distance in inches from the center of the truck to the center of the side bearing, then divide this product by the radius in feet of the curve.

MECHANICS OF THE CHILLED IRON WHEEL*

Chilled iron possesses inherent qualities which are not found in other metals and its principal characteristics are its ability to carry any load that can be supported by the steel rail without crushing or flowing.

The mechanics of the chilled wheel have never been investigated except in a very superficial way. The fundamental properties of chilled iron, such as specific gravity, modulus of elasticity for varying tensile strengths, action under repeated stresses, relation of operating conditions to temperature stresses, etc., are not established. If the properties of chilled iron were fully understood and properly used in the wheel, a large return on the meager expenditure for investigation would flow in upon the manufacturers in the way of increased profits and to the railroads in the way of reduced costs.

The loads carried by the wheels and rails have been constantly increasing and the question now arises—are we nearing the limit for wheel loads? If so, what is the determining factor? What margin still remains for further increases, in bearing power of the metal of wheel and rail, in flange strength, in web and hub? These are the questions we propose to answer by considering each part of the wheel separately.

Bearing Power.—The bearing power of iron or steel is largely controlled by the carbon content and naturally since the tread of the cast iron wheel contains 3½ per cent of carbon it has a much greater bearing power than the rail which contains less than one per cent of carbon. A 33-in. chilled iron wheel will not perceptibly flatten under a load of 250,000 lb., which is 8 or 10 times the present maximum wheel load. Chilled iron wheels are in common use carrying 100,000 lb. or more under large cranes, unloading bridges, transfer tables, hydraulic locks, etc. To carry these loads wide special flat-top rails are necessary.

The ordinary railroad rail with a 12-in. top radius will develop a permanent set when the indentation of the wheel into the rail amounts to .007 in. If we assume that the maximum load carried in rapidly moving service should not cause when at rest an indentation greater than one-half this amount, the limiting loads from the rail standpoint are readily calculated by the formula $L = 1,500,000 d \sqrt{D}$ in which L equals load, d equals indentation into the rail and D equals diameter of the wheels. In this formula the pressure per square inch over the area of contact between wheel and rail is taken at 100,000 lb. per sq. inch. The limiting loads for various diameters of wheels are:

42 in. wheels.....	34,000 lb.	33 in. wheels.....	30,200 lb.
36 in. wheels.....	31,500 lb.	30 in. wheels.....	28,800 lb.

As far as the bearing power of chilled iron is concerned there is no indication of nearing the wheel load limit.

The Flange.—The pressure which the flange must resist in guiding the truck around curves is equal to ¾ the wheel load, provided the track is perfect and the cars are in good

*The light weight of the entire car was used in the above instead of considering the light weight of the car body and the trucks separately, to make the problem simpler.

* Abstract of a joint address delivered before the Railway Club of Pittsburgh by George W. Lyndon, president, and F. K. Vial, consulting engineer, representing the Association of Manufacturers of Chilled Iron Wheels.

condition. The pressure is not influenced by the degree of curve, velocity, centrifugal force or obliquity of traction, but an allowance must be made for impacts originating from irregularities in track and locked side bearings and center plates, which added to the curve pressure will make the total maximum lateral pressure against the flange $1\frac{1}{2}$ times the wheel load, or 18,000 lb. for the 30-ton car and 46,500 lb. for the 85-ton car.

It is unreasonable to suppose that a flange designed for an 18,000 lb. pressure will have the same factor of safety for 46,500 lb. pressure, in fact the thickness of flange was developed when flange pressure did not exceed 8,000 lb. It is just as necessary to increase the flange section as to increase all other sections of the wheel, when increased duty is imposed. Notwithstanding the fact that the Master Car Builders' Association in its latest report stated that no increased flange width was necessary, this matter is by no means settled as far as other associations are concerned, and a movement is again started to determine whether the hundreds of thousands of flanges that are now in use (which are wider than the present M. C. B. standard flange) are not entirely in harmony with present track standards.

When this question is answered, we will have an opportunity to present to the Master Car Builders' Association a flange with a factor of safety proportional to the load carried, which is not a difficult proposition and which from an engineering standpoint is demanded.

Stresses Within the Plate or Web.—The University of Illinois has undertaken a thorough analysis of the properties of chilled iron and of the stresses within the wheel originating from all conditions that can arise in service as far as they can be duplicated in the laboratory. These items include specific gravity, co-efficient of expansion by heat, modulus of elasticity, tensile and compressive strengths, stresses in the wheel originating from pressing on the axle, from vertical load, from side pressure on the flange, and from difference in temperature between the tread and the plate. Tests are also to be made to discover the probable difference in temperature between the tread and the plate for continuous application of various brake shoe pressures at various velocities. An indication of the magnitude of the stresses within the wheel already has been determined as follows:

From pressing on an axle having a 7-in. wheel fit at 60-tons pressure, 18,000 lb. compression per square inch is developed in the single plate; the greatest tensile stress is in the hub. If the machine work is fairly well done these stresses are symmetrical, but if the wheel is irregularly machined, the stresses will be bunched and necessarily greater than normal, being at times sufficient to burst the hub. Under a vertical load of 200,000 lb. the maximum compressive stress occurs on the radial line between the rail and the hub amounting to about 18,000 lb. in the 725 lb. M. C. B. wheel; the tensile stresses in the tangential direction are about 12,000 lb. These stresses alternate at each revolution of the wheel. The maximum stresses are in the front plate. In the back plate the load stresses are practically nil.

The stresses from vertical load within the limits of railway practice are practically negligible.

The greatest stresses, and therefore the most important are the temperature stresses; for example, a 625 lb. wheel was placed in a brake shoe testing machine and operated at various velocities under a continuous shoe pressure of 1,500 lb.; this corresponds to the retardation required for a 50-ton car on a 3 per cent grade when operated at 5 m. p. h. and on a 2 per cent grade when operated at 50 m. p. h. Thermo-couples were placed $\frac{1}{2}$ in. under the surface of the tread, under the rim, at the plate intersection and in the hub. These couples were connected by brushes to a collector ring insulated from the axle so that temperatures could be taken from any part of the wheel at any time without stopping the machine. After running the equivalent of 25

miles, the maximum stresses developed near the intersection of plates were found to be:

5 miles per hour.....	10,000 lb. per sq. in.
10 miles per hour.....	12,000 lb. per sq. in.
20 miles per hour.....	15,000 lb. per sq. in.
30 miles per hour.....	18,000 lb. per sq. in.
40 miles per hour.....	21,000 lb. per sq. in.
50 miles per hour.....	24,000 lb. per sq. in.

Since the above is a greater retardation than is required for controlling 30-ton cars it is evident that if the shoe pressure could be made uniform on all wheels of the train there would be no over-heating of wheels but there are so many opportunities for irregularities in service that at least 200 per cent above the theoretical retardation required must be taken into consideration when designing wheels. The text also indicates the great benefit of thermal or cooling stations. Making standards for the car wheel without reference to fundamental principles is absolutely unjustifiable.

We may say frankly that the work which has been done for the past eight years by our association, in conjunction with committees and other associations with which we have had to deal, has not yielded us material results; nevertheless we have gone along in our work, firmly believing that we were on the right track and that sooner or later our recommendations would be endorsed.

CUT JOURNAL—OWNER'S DEFECT*

BY F. H. HANSON

Assistant Master Car Builder, New York Central, Cleveland, Ohio

We all know the question of hot boxes and cut journals is one that is at the present time giving the railroads throughout the country an unusual amount of worry on account of the enormous amount of business they are handling. Every effort possible is being put forth by some roads to overcome this trouble by using the best steel axles, journal bearings, etc., that can be procured; also by giving special attention to truck defects, endeavoring to put the wheels and axles, journals, journal boxes and contained parts in the best of condition. Some roads have installed a system of periodical repacking of boxes on their cars at which time all journal bearings and journal bearing keys are removed and examined, journal boxes cleaned, dust guards and journals examined, and any of these parts that are found defective sufficient to be condemned are replaced. The boxes are then repacked with fresh packing. The cost of repacking varies from \$2.14 to \$3.58 per car, according to the capacity.

While it is the opinion of some that the majority of our hot boxes are caused by the so-called lack of attention on the part of the handling line, I cannot agree that this is the case. I do claim, however, that if the proper attention is given to the packing of boxes it will avoid some of our hot box troubles. On the other hand, I claim that the majority of our hot boxes and cut journals are caused by mechanical defects that cannot be detected with the naked eye at the time of application or by ordinary inspection, but after being put in service, they develop, resulting in hot boxes. Some of these defects are cracked brasses, loose lining, shell back brasses which crush when under load, pitted bearing surfaces caused by improper pouring of the brass and babbitt composition, filled brasses, malleable iron skeleton back keys, etc.

We have found when filled brasses and skeleton back keys are used (which is quite frequent) that these keys work into the roof of the journal box and in some cases become locked, crowding the journal bearing to the collar of the journal producing abnormal end wear and often a hot box. This working into the top of the journal box or wearing away of the top lugs is sufficient cause for the scrapping of one or both parts, and if not done will soon cause a hot box.

In addition to these defects that cannot be detected by ordinary inspection there are many others that are contribut-

* From a discussion before the Niagara Frontier Car Men's Association.

ing factors towards hot boxes. Some of the most important of these are broken or defective boxes allowing the oil to leak out, box lids and dust guards missing or defective, broken truck bolsters and spring planks, side bearings with insufficient clearance which prevents the alinement of the truck thus causing undue strain on the bearings, rough castings such as truck side frames and journal boxes not properly machined causing the boxes to tilt, journals not properly finished on new equipment, etc. It is a well known fact that defective journals unless running hot cannot be detected in interchange. Also it is known that journal bearings that are rejected at the manufacturers by our material inspectors for minor defects and non-gauging are purchased and used by certain railroads and private car lines.

In order to know the true condition of the bearings in some of our cars, we had a record taken of the different defects found when examining the bearings while cars were undergoing repairs, and out of a total of 5,668 bearings examined, 116 or 2 per cent were defective, due to the following defects: Uneven bearings caused by defective arch bars or truck sides, end wear, due to trucks being out of alinement (in some cases the end wear was so great as to greatly reduce the area of the bearing surface), babbitt worn thin and cracked with pieces becoming loose and dislocated.

This seems to show clearly some of the defects that do actually exist which cannot be detected by ordinary inspection, but which will soon cause a hot box and perhaps a cut journal, and when this does occur it should be properly chargeable to the car owner. This, I claim, also shows the necessity of removing and examining these parts at certain intervals, which is not being done by some car owners.

To verify this, we recently had the packing removed from about 200 foreign cars and found 28 cars with the packing in very bad condition, and which might be termed as worn out. Out of the 28 cars 9 were private lines cars, which had recently been given a general overhauling as follows: One in December, 1916, and eight in January, 1917.

These conditions plainly show no attention, whatever, had been given to the condition of the boxes on these nine cars when they were in the shops for repairs. Is it not fair to assume that if cut journals were at this time a car owner's defect that the trucks under these nine cars would have been given the necessary attention by the owners when giving the cars general repairs? The packing at least would have been given the necessary attention. The old saying of "An ounce of prevention is worth a pound of cure" applies as fully in such cases as any that could be cited.

Again, some car owners are still using wrought iron axles, and it is claimed to be almost impossible to manufacture wrought iron axles that are free from seams owing to the character of the scrap iron used in them. It has also been stated that in Europe, where the low carbon steel axle is used, they seldom have a hot journal, and consequently it seems to be the opinion of some axle manufacturers that the softer texture of steel would tend to reduce the liability of hot journals. All of which goes to show that the majority of hot boxes are caused by some mechanical defect or combination of defects.

One of the important decisions made by the M. C. B. Arbitration Committee is its interpretation of Rule 85, as shown in M. C. B. Circular 20, making the car owner responsible for a cut axle caused by a brake chain or brake rod bearing on the axle. If a defect of this kind that is plainly visible and might be attributed to the carelessness or neglect of the handling line in not properly adjusting the brake rods, brake chain, etc., has been placed among the car owners' defects, surely the time has come for the cut journal caused by concealed mechanical defects to also be made an owner's responsibility.

Consider the case of a car received at an interchange point with no evidence of any defect. Suppose the boxes

of this car are given attention and the brasses and keys from all outward appearances are in good condition. The packing is thoroughly stirred and additional packing or oil is added, if needed. The car goes forward, but after running a few miles a hot box develops, and on examining the brass and journal it is found that a new brass is needed, which is applied, and a bill rendered against the car owner, which is proper. Carry this case a little further, and suppose, on examining the journal, it is found to be cut. Then, according to the present M. C. B. rules this pair of wheels must be removed, the journal turned up and replaced or another pair of wheels applied in their stead at the cost of the handling line.

With all fairness to both the car owner and the handling line—is it fair to penalize the handling line in such cases? Surely it cannot be attributed to lack of attention on the part of the handling line, and if not, it certainly should be an owner's defect. When it is made an owner's defect, I claim we will soon see an improvement in the condition of the boxes, for the owners will then pay some attention to these conditions, knowing that any trouble they can prevent due to hot boxes while car is on foreign line will prevent a bill from being rendered against them. I further contend that this will work out to the best interests of both the owner and handling line. The time has passed for us to say that the majority of our hot boxes could be prevented by the exercise of proper care by the handling line.

SAFETY HANGER FOR BRAKE RIGGING

The Elgin, Joliet & Eastern has applied to a large number of its cars a simple and effective form of brake rigging safety hanger. It is shown attached to a truck in the illustration. The safety hanger is made of $\frac{3}{8}$ -in. plate, fitted over the flange of the spring plank and having a hole through which the bottom brake rod passes. While the design shows the device applied to a truck having a spring plank composed

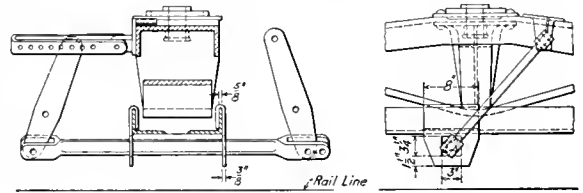

Brake Rigging Safety Hanger

of two angle irons, a similar arrangement can be used on trucks having spring planks of other types. The feature of this type of safety hanger which makes its use particularly advantageous is the fact that it affords protection to the brake rigging from practically all failures. Whether the failure is due to a bottom rod breaking, pins working out or the brake hangers giving way, the safety hanger keeps the rigging from dropping and being torn off or causing a derailment.

TECHNICAL PROPRIETY IN ENGINEERING SOCIETIES.—However laudable may be the desire to maintain the proceedings of our great engineering societies on a high plane of technical propriety, it cannot be denied, even though it has been ignored in the past, that the engineer is everywhere confronted in his work by the all-important question of costs and balance sheets, and himself is usually under the necessity of earning a livelihood by his profession. Hence, an ostrich-like pretense that trade and finance have no concern for him is mere affectation, and we are glad to see that both the civil and electrical engineers have begun, somewhat shyly it may be, but effectively, to recognize their responsibilities in this connection.—*The Electrical Review* (London.)



SHOP PRACTICE



HANDLING RODS AT MACON SHOPS*

BY C. L. DICKERT
Superintendent of Shops, Central of Georgia, Macon, Ga.

When locomotives are stripped all rods, brasses, etc., are sent to the cleaning vat for cleaning, being handled from the engine to the vat by an overhead traveling crane. The cleaning vat is located at the end of the erecting shop. All parts that are to be cleaned are placed in a basket large enough to hold all parts from one locomotive. This basket is placed in the vat in the afternoon and allowed to soak over night. The first thing the next morning the basket is removed and

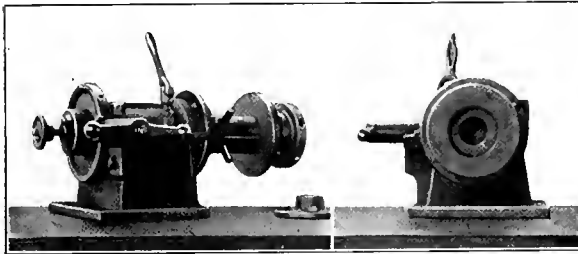

Chuck for Slotting the Strap Fit in the Main Rod Brasses

placed on the floor and the parts are washed with clear water. The rods are then delivered by a special gang of laborers to the rod gang, where they are thoroughly inspected for cracks, worn eyes, worn or cracked straps. If the rods or straps are bent they are sent to the smith shop for straightening. If the straps are worn they are sent to the smith shop to be closed and they are re-slotted when heavy enough to be reworked. When they are cracked or are too light new straps are made. We do not weld cracks in the rods or straps. Where the rod eyes or knuckle pin holes are worn they are carried to a horizontal boring bar by a traveling crane, and the rod eyes are bored true and the knuckle pin holes are reamed.

Before the rods are removed from the pins, when stripping the locomotive, the foreman or some competent man determines whether or not the bushings need renewing. If all or part of the bushings are good, the foreman notifies the leading man in the rod gang. This eliminates the necessity of the rod gang men calipering the pins to see whether or not the bushings need renewing. Frequently rod bushings are applied in the roundhouse just before the locomotive goes to the back shop and do not need renewing. When the collars are removed from the crank pins, it takes but a few minutes to inspect the bushings. When new bushings or main rod brasses are needed, a storehouse ticket is issued giving the pattern number of the brass. This ticket is placed in a ticket receiving box, several of which are conveniently located throughout the shops. Messenger boys from the store department visit these ticket boxes every twenty-five minutes during the day, gathering up tickets and

taking them to the store house. The store house force fills the orders and delivers them promptly to the department ordering the material. If the material wanted is not on hand the store house clerk writes on the ticket "Not on hand" and returns it to the foreman issuing the ticket.

All rod, knuckle bushings and main rod brasses are turned and bored on a Bullard boring mill. We find that the work can be done much quicker on this machine than on an engine lathe. The main rod brasses are machined for the strap fit on a Dill slotter, special chucks for the brasses being fitted to the slotter. Better time is made on this machine than can be made on a shaper. All rod strap bolts up to and including $1\frac{1}{2}$ in. by 16 in. are turned on a Lassiter four-spindle bolt turning machine, and are carried in the store stock. When bolts are needed for a set of rods, they are cut to length on a bolt altering machine and threaded in a bolt cutter.

All knuckle and wrist pin blanks are made on a 6-in. Pond turret lathe and carried in stock. When they are needed they are threaded and cut to length in the turret lathe, leaving only the bearing and fits to be made. Knuckle pins for all classes of locomotives have a taper for the fits of $1\frac{1}{4}$ in. in 12 in.; the wrist pins have a taper of $\frac{5}{8}$ in. in 12 in. Having one taper for the fits on all classes of locomotives makes less work for the tool room in the maintenance and manufacture of reamers. The rod keys are forged on a drop hammer. The rod wedges are made of cast steel. The rod wedge bolts are made on a turret lathe and are carried in store stock.

The rods are forged from the best hammered iron and

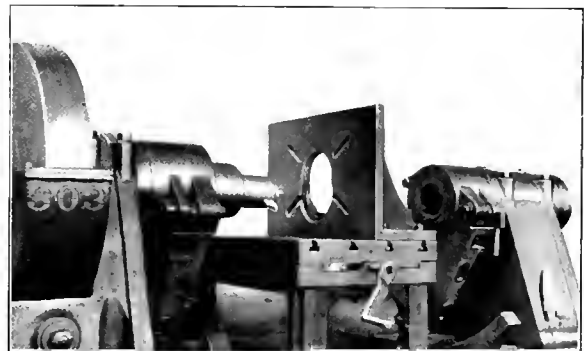

Adjustable Chuck for Boring Rod Eyes

are planed and channeled on a slab milling machine. The ends are finished on a vertical miller, the knuckle jaws being milled on a No. 5 Ingersoll milling machine. The rod eyes are bored on a Newton cylinder boring bar, a special chuck being made to fit the machine for this class of work. All grease cups are made solid on the rods when they are forged. The cups are drilled and tapped on a heavy drill press. Grease plugs are made of malleable iron;

* Entered in the Rod Job Competition.

they are machined in quantities and carried in store stock being drawn when needed.

The machines in the rod group consists of one 18-in. engine lathe, one shaper, one boring mill, one power press, one cold saw, one drill press, one sensitive drill press, one disc grinder, one swing grinder, one slab miller, one vertical miller, two face plates and two work benches. All holes are reamed with an air motor. The rod group is served by the shop traveling crane and one jib crane. All rods are lifted with cranes and handled between departments with the Hunt system of industrial tracks. Thus the least possible amount of labor is required to handle the rods from the time they are removed from the locomotive until they are applied. When the rods are finished they are delivered to the erecting shop by the department doing the work. This method of handling simplifies deliveries, as each department keeps the work moving and enables the foremen to keep their departments clean.

HAND TOOLS AND SAFETY FIRST*

There are still many operations that require the use of hand tools in a machine shop. Among these are filing, chipping, benchwork in general, and blacksmithing. The thought of danger is specially associated with moving machines, but although these do cause a great many accidents, a surprisingly large proportion of the injuries received in machine shops results from the use of hand tools.

The possibilities of accidents in connection with machines are easily apparent. The swift, untiring motion, and the grinding, clattering, and whirring sounds, suggest relentless force; and while machines are in motion, contact of any portion of the human anatomy with certain parts of the machines almost inevitably results in personal injury. Carelessness may or may not be an important factor in an accident of this kind.

Hand tools, however, are apparently quite harmless; yet (as stated above) they cause many accidents, and nearly all such accidents may be fairly attributed to personal carelessness or neglect. Mis-handling tools, neglecting to keep them in good condition, and leaving them about in dangerous places, are forms of carelessness that cause trouble sooner or later.

Suppose a machinist is about to file a piece of work in a lathe. Handles come off from files quite frequently, and they are not always easily found when wanted. In the hypothetical case that we have in mind, the machinist starts to work with a file that is minus a handle. When working close to the lathe dog the end of the file is struck by the dog and the pointed tang is forced backward into the man's hand or wrist, or possibly into his abdomen if he is standing directly in line with the file. A similar accident may occur while working at the bench if the file breaks, or if it slips in the workman's hands, although the results are usually less serious in a case of this kind. *Never use a file without a handle.*

A painful accident sometimes occurs when a workman, in attempting to drive a file more firmly into its handle, grasps the tool by the handle instead of by the metal part. A heavy file will sometimes drop out in a case of this kind, remaining balanced in a vertical position on the bench for a moment, so that the man's hand or wrist comes down violently upon the sharp tang. *In tightening a file by pounding on the bench, always grasp it by the metal part, instead of by the handle.* Some shops use safety handles of special design. In one form a hardened steel nut with sharp threads is inserted in the handle, and the handle is twisted on with considerable force. The sharp threads of the nut then cut into the tang and hold it securely in place.

Another man may be setting up a large nut with an open-

end wrench that is a trifle too large for the nut, or the jaws of which have been battered or twisted out of shape by mistreatment. In either case the wrench is likely to slip off the nut, and the workman's knuckles may come in contact with some hard object and be cut and bruised, even if nothing more serious occurs. *Use a wrench that is in good condition and of the proper size.*

Workmen often use monkey-wrenches for hammering, and thus damage the jaws or the adjusting screws, so that when the wrenches are put to their proper use the jaws slip around the nuts and more knuckles are bruised and require attention. *Never hammer with a monkey-wrench.*

Similar bruises often result from applying monkey-wrenches improperly. If the wrench is used in the position shown in Fig. 1, for tightening a nut, the jaws are likely to spread and to slip off the nut when force is exerted upon the wrench handle. The correct method is shown in Fig. 2. When the wrench is used in this way the pull on the handle tends to tighten the jaws, and thus causes them to grip the nut more firmly. As an additional precaution, avoid using a monkey-wrench as a substitute for a socket wrench, whenever possible.

A chipper who fails to wear goggles and to provide a needed screen to protect other persons against flying chips

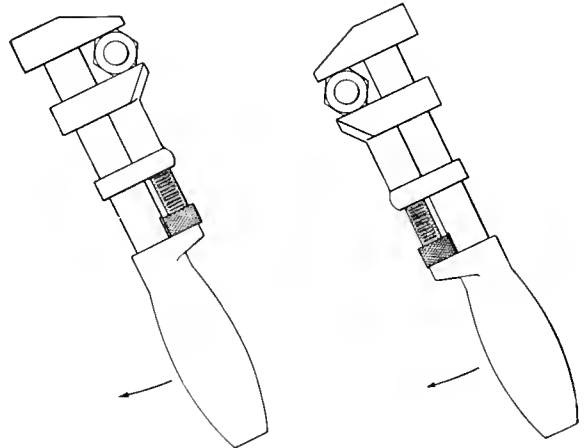

Fig. 1—Wrong Way

Fig. 2—Right Way

from his work, has only himself to blame if the chips strike his own eyes, or those of some other person, and cause painful injuries.

The danger associated with the use of punches, cold-chisels, hand drills, and other similar tools, when the heads are worn, burred, or "mushroomed," has been pointed out by nearly every writer on safety topics. Men continue to use these defective tools, however, and, as a result, from time to time flying burrs or spalls that break off inflict cuts and bruises on the arms or faces of the users, or of persons near by. When the flying fragments of metal strike the eye, the result is likely to be a permanent injury or even a total loss of sight. Furthermore, when the tool being struck has a burred head, the hammer is more likely to slip off and injure the hand that is holding the tool. *Have chisels and other similar tools dressed whenever the heads are burred.*

No workman should knowingly use a sledge hammer that is loose on its handle or that has a split handle, nor any other defective tool. If the tools are the individual property of the workman, he should inspect them frequently and have them put in good condition before using them; and if they belong to his employer he should notify the foreman if they are defective, and insist on having safe implements. A good plan is to have all hand tools, and particularly such

* Taken from The Travelers Standard for July.

tools as sledges and others with wooden handles, kept in the tool room, to be checked out only when needed. In this way one man—the tool-room keeper—can be made responsible for seeing that no defective tool reaches the hands of a workman.

Tools left lying in passageways, and near the edges of platforms, benches, racks, and shelves, and on step-ladders, are potential accident producers. "A place for everything, and everything in its place" is the safe rule for sharp-edged, heavy, and otherwise dangerous tools.

Insecurely placed work—perhaps a heavy casting or forging—often falls from the bench, endangering the feet and limbs of the workman. Avoid this danger by keeping such objects in safe positions, and by properly supporting or securing them, whenever necessary.

Every machinist doubtless knows that striking tempered steel with a steel hammer or other steel or iron implement endangers the eyes, but every little while somebody tempts Providence by trying the experiment again.

When cutting a short piece from a rod or bar of metal with a sledge and a blacksmith's cutter, the short end, when severed, is likely to fly and injure someone, unless care is used to strike lightly when the rod is nearly cut through. The smith also knows (or should know) that to avoid flying pieces he must stand at one side when doing this work.

Broken and bent tongs and tongs that do not fit the work are unsafe. Repair all broken tongs at once, or put them in a safe place where they will not be used. Don't hang hot tongs in the rack, because someone may grasp them with the intention of using them, and be severely burned.

Contrary to safe practice, pieces of hot metal are often left lying about on anvils, benches, and other places, and these may burn any person who attempts to pick them up. Mark hot pieces in some unmistakable way, so that burns from this cause will be avoided.

Finally, there is the ever-present danger of infection that is associated with even the slightest wound or abrasion of the skin. Such injuries are daily occurrences in machine shops, and are often considered too trivial to require attention. Nevertheless, they frequently lead to serious cases of blood poisoning.

The lesson that we desire to teach and to emphasize in this article is "Exercise greater care in the use of hand tools." Forget the *apparent* harmlessness of these implements, and remember the capacity that they have to cause suffering, when mishandled or when used carelessly or negligently.

CONSERVE MATERIAL

The Seaboard Air Line in its Store Department Bulletin for July has made a very strong appeal for the conservation of material. It applies so aptly to all railway shops that it is reproduced, in part, below:

"Do you find the prices being lowered on any articles you may buy for your personal use? On the other hand, they are being constantly increased.

"The Seaboard is feeling this same condition, and the dollar it spends for material and labor does not go any farther than your dollar. On the other hand, many of our employees have received increases in wages, whereas the railroad must shoulder these increases in labor and material and operate on the same rates. In the face of such conditions, we must economize in the use of material in every way.

"We can all do more than we have done. It has been necessary on account of enormous increases in the price of material to conserve it in every way. Practically every item of material which we use can in some state be used for war purposes. It is now a patriotic duty of every employee to conserve iron, steel, lumber and other material, so that any excess may be available for war purposes—*do your bit.*

"There is a serious shortage of steel products. The Government has served notice on mill owners with reference to the steel output for building ships. We can not expect the deliveries which we have had in the past, and prices have already increased over 400 per cent. As is the case with many other items, bar iron and sheet steel should only be used when absolutely necessary. Save the stocks of iron and steel by using second-hand and scrap.

"Every mechanic, foreman and employee should devise methods of saving material. We must admit that we can make savings, and savings are being made in many ways by a thorough investigation. Every officer and employee should do his full duty to conserve the use of material and only make a requisition for material when a full knowledge of conditions warrants the money being spent. As recently stated in a circular by President Harahan, 'Every requisition for material and supplies should be scrutinized with the greatest care, and full knowledge of conditions which exist. By close co-ordination and discouraging calls for hundreds of small items of material and supplies, we can greatly reduce our purchases without impairing maintenance and operation of the railroad.'

"Following are prices of material January 1, 1915-1916-1917. We cannot reduce the price. The only way to make a saving is by reducing the use, and properly protecting material after purchase. Save your material.

	1915	1916	1917
Axles, Driving	(lb.) \$0.03	\$0.04½	\$0.06½
Brass Castings	(lb.) .12	.14	.29
Brooms	(each) .25	.28	.57
Coke	(ton) 3.65	3.76	7.00
Chain	(cwt.) 2.44	3.65	5.65
Castings, Malleable	(lb.) .03½	.04½	.06½
Castings, Steel	(lb.) .03½	.04	.09
Couplers	(each) 9.00	9.80	14.75
Gasoline	(gallon) .09	.13½	.19
Iron, Bar	(cwt.) 1.15	1.76	3.27
Iron, Galvanized Sheet	(cwt.) 1.94	4.44	7.25
Nails	(cwt.) 1.65	1.95	3.25
Nuts, Hex. 7/8 in.	(cwt.) 7.86	12.96	26.10
Nuts, Square	(cwt.) 3.92	6.08	10.25
Pins, Knuckle	(each) .17	.25	.42
Rivets	(cwt.) 2.00	2.52	4.24
Roofs, Car	(each) 24.00	26.00	44.21
Siding	(1,000 ft.) 12.50	14.00	18.50
Steel, Firebox	(cwt.) 1.74	1.90	4.57
Steel, High Speed	(lb.) .35	2.50	2.55
Stiles, Boiler	(ft.) .07½	.11	.21
Tires, 6 in. Flange 65 in.	(set) 238.46	248.21	475.64
Wheels, Rolled Steel, 36 in.	(each) 22.84	23.04	37.58
Waste, Wool	(lb.) .05½	.06	.11
Waste, Cotton	(lb.) .04½	.05½	.10

AUTOMATIC OIL FILTER

BY E. A. M.

An arrangement for filtering and reclaiming the oil from stationary engines, machines, pumps, air compressors, etc., which has been giving excellent service during the past two years, is shown in the illustration. This arrangement is designed to work automatically; the oil from the power units flows to the filter by gravity and a pump which is operated by a float returns the oil from the filter to the storage tank from which it is used again. Its use has clearly demonstrated its practicability and since it was designed five others have been built.

The filter consists of four tanks of 21½ in. in diameter. The oil is received in a small tank of 12 in. in diameter which is located in the tank at the left of the illustration. This small tank is 25½ in. high, extending 1 in. above the top of the large tank in which it is located. The bottom of this small tank is a brass screen of fine mesh on which is placed a layer of felt and above that a little wool waste. The oil from the power units is filtered through this material to remove the dirt. It passes on to an inverted, corrugated umbrella-shaped pan which tends to break the oil away from the water. The oil rises to the top of the tank and the water passes to the bottom. When the oil reaches a level of 35 in. in this tank, it passes out through a 1-in. pipe to a similar corrugated umbrella pan in the second tank. The water

passing out through the bottom of the tank through the 2-in. water line, passes up through a riser to a height $\frac{1}{4}$ in. below that of the oil. The water drains off through the 2-in. water pipe shown to the sewer.

The water and the oil in the second tank become further separated, the oil rises to a height of $3\frac{3}{4}$ in. when it passes

A HANDY STAYBOLT CHUCK

A chuck for turning staybolts when applying in the fire box sheets which does away with the necessity of squaring the ends is shown below. The driver, which is made of tool steel, turns readily in the recess in the body of the chuck. It

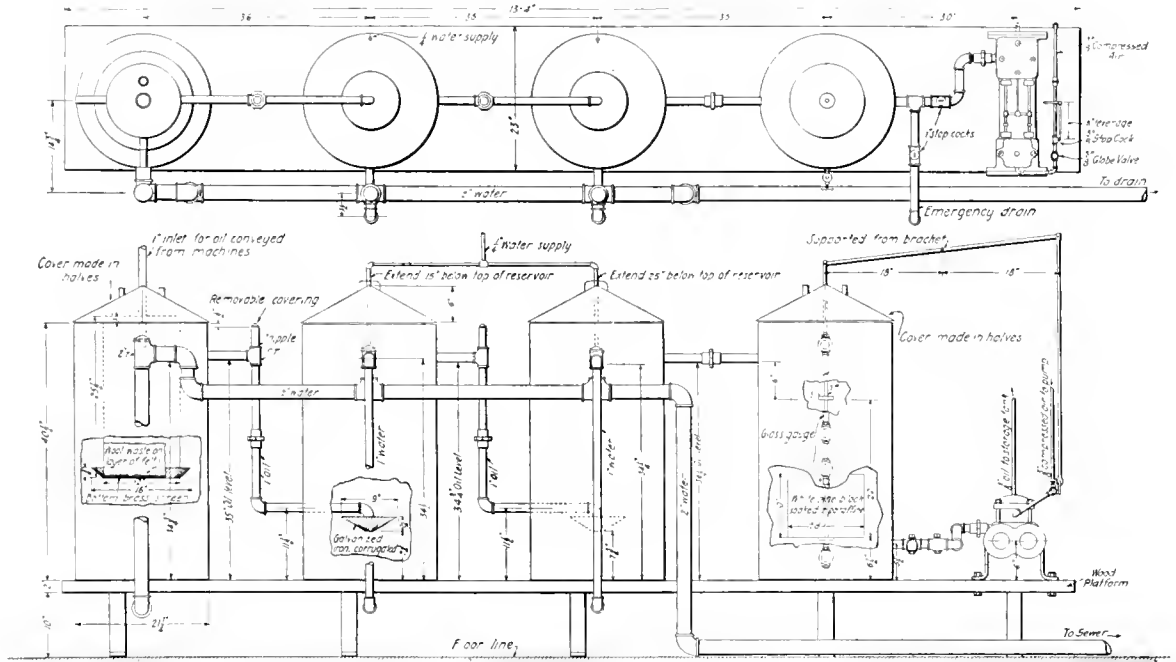

Arrangement of an Automatic Oil Filter

over into the third tank. Similarly, the water this time passing up through a 1-in. pipe to a level of $3\frac{1}{2}$ in., or $\frac{1}{4}$ in. below the level of the oil, passes off to the sewer through the 2-in. water pipe. The same process is carried through in the third tank. Inasmuch as but little water is obtained from the oil in the second and third tanks, a small amount of water through a $\frac{1}{4}$ -in. water supply is admitted to these tanks at a point 15 in. below the top of the reservoir to assist in operating the system. By the time the oil reaches the fourth tank it is in first-class condition. From there it is pumped to an elevated storage tank for distribution. The pump is automatically operated by a white pine block soaked in paraffine which is 12 in. in diameter and 10 in. high. This block rises with the oil until it strikes a washer forged on the rod on which the block slides. The buoyancy of the block is sufficient to work levers starting the pump. A similar washer at the bottom of this rod catches the float as it lowers to the bottom of the tank and shuts off the pump. There is a difference of $\frac{1}{4}$ in. in the oil level in the different tanks except between the third and fourth. This insures a positive flow of oil between them.

SAFETY FIRST.—The Great Western Railway (England) statistics as to accidents to its employees showed, up to 1913, an almost invariable tendency to increase. In 1914, however, this tendency was arrested, and, whereas in 1913 the increase was 11.2 per cent, in 1914 it was converted into a decrease of 3.7 per cent, and in 1915 and 1916 to further decreases of 16.2 and 10.9 per cent, respectively. It is claimed that this improvement may be associated with the initiation in 1913 of the "Safety First" movement.—*The Engineer (London).*

is held in place by the knurled cap. The chuck is slipped over the head of the staybolt and the driver engages as soon as the motor turns. When the bolt has been screwed in the proper distance the chuck is disengaged by turning in the opposite direction for a short distance.

In operating the staybolt chuck it may be used most conveniently with a reversing motor, although it can be

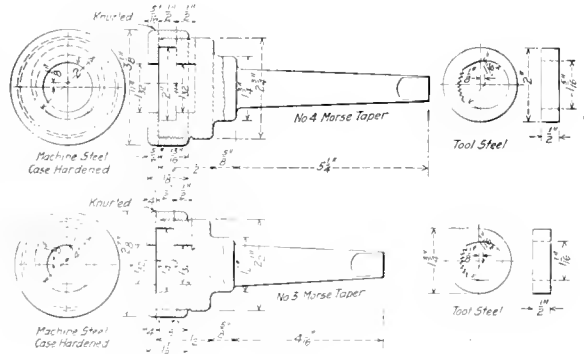

Chuck for Turning Staybolts With Ends Not Squared

removed without difficulty when a non-reversing motor is used by turning backwards by hand about a quarter turn. The drawing shows two sizes, the recesses in the bodies of which are $1\frac{3}{4}$ in. and 2 in. in diameter, respectively. These have been found to have a wide enough range to take care of all the sizes of staybolts commonly used.

MACHINING CAR WHEELS AND AXLES

Benefits Derived by Greater Precision in This Work; Methods Followed by a Large Railroad Described

CONSIDERING the heavy character of the work done in machining car wheels and axles and the number of tons of metal handled per day, the short time taken to machine each wheel or axle and the fact that this work is performed in many small shops where expert supervision cannot be expected, the number of delays to train movements from defective workmanship on this part of the equipment is surprisingly small and speaks well for the conscientious care given this subject. Recent improvements in the performance of this class of work have been made possible by the use of recording pressure gages on wheel mounting presses that make a graphic record of the pressure at which wheels are pressed onto the axles, by more substantial lathes and boring machines and last, but not least, the use of micrometer calipers to check the work. This work appears crude to persons accustomed to machine manufacture. However, the work as performed in the average shop stands the test in actual running conditions and to go to greater refinements would only add to expense without compensating benefits.

A description of the method followed in one of the leading railway shops follows:

CAR AXLES

Car axles are generally turned on special center-drive double end axle lathes of heavy construction on which both ends of the axle are turned at the same time. A series of tests were conducted to ascertain the proper cutting speed and feeds best adapted for this work, for which purpose a variable speed motor was belted to the lathe. This test indicated that the best all around results can be obtained when running about 45 r. p. m. on the larger axles, such as 5-in. by 9-in. journals and feeding about 1/16 in. per turn. This gives a cutting speed between 80 and 90 ft. per minute on the 7-in. wheel seat. With good average high speed steel and a liberal supply of water or cutting compound applied to the point of the tool, the tool would hold its edge for several axles. Higher cutting speeds while possible with good steel had a tendency to cause the axle to chatter and were not recommended for practice. This comparatively high cutting speed and feed of about 1/16 in. per revolution produced a fairly smooth surface that would meet the requirements for wheel seats and also the journals were turned smooth enough for average burnishing.

Considerable controversy has been indulged in concerning slow cutting speeds and coarse feeds versus fast cutting speeds and fine feeds. With the average workman grinding and setting his tools, there is no question but that on the average a smoother job could be produced with the high speeds and fine feeds, and as a result the lathes were speeded up to about 45 r. p. m. An axle wheel seat turned with a 1/16-in. feed will permit re-mounting three or four times without re-turning the axle, whereas with a coarser feed and deeper humps and hollows, the humps are pushed off more when mounting and dismounting and call for more frequent turning.

After the turning operation, which is going on at each end of the axle at the same time, the journals are rolled or burnished. This operation is now quite common. The burnish wheel which is about 4 in. in diameter is made of carbon steel, hardened and carefully ground on the periphery and in the hole, one edge of the wheel being made convex to about 1/16 in. less in radius than the fillet on the axle. The other surface of the wheel is straight. This burnish

wheel is mounted in a forked holder that is secured in tool posts, the burnish wheel revolving freely on a shaft passing through the fork. By pressing the burnish wheel against the axle and feeding the carriage back and forth, the journal becomes very smooth and a surface that gives satisfactory service is formed. Care must be taken to set the burnish wheel true with the axle to prevent rolling a shallow thread on the journal. The fillets are finished by feeding the carriage by hand so as to roll the entire fillet.

As a further refinement, journals are finished with emery cloth fitting in a soft wood block concaved to the radius of the journal. The wood block is forced against the journal by the tool post and is fed back and forth, the emery cloth being well oiled to prevent the emery lodging in the axle. Afterwards the journals are carefully wiped to remove all loose emery.

The method outlined above produces a very satisfactory journal. A simple test for determining the high and low spots on a journal is to lightly rub a new hand emery or oilstone lengthwise of the journal and note the marks on the surface. A truly turned or ground journal will show almost a continuous line from end to end. Poorer work produces only a few spots.

In order to insure good workmanship it is essential that all axles be properly measured or calipered, both to check the workman and to insure that lathes are in a proper state of repair. The micrometer caliper is now very extensively used for this purpose and where used has invariably raised the standard of workmanship, lessened failures and has become very popular with the workman, so much so that it would be difficult to make them go back to the machinist calipers for measuring the work. When turning wheel seats to fit wheels, or boring wheels to suit axles with calipers, the workman must set one set of calipers to another set and make allowance for the amount the axles should be larger than the wheel bore. This at best can only be an approximation and requires a man of considerable experience to insure proper dimensions and wheel fits. With the micrometer caliper the axle diameter and wheel bore can be measured exactly, so that the amount the axle is larger than the wheel bore is known to one or two thousandths of an inch. Practice has clearly demonstrated that measurements can be made more quickly by a micrometer than by machinists' calipers and all wheel shops making use of other than micrometer calipers should carefully consider their use. The question of educating men to their use at first appears a bugbear, but experience has shown that this was only a "bugbear" for the men soon come to prefer the micrometers.

It is good practice to measure each wheel seat at each end and in the middle with the micrometer calipers. A wheel seat should not vary in diameter more than .004 in. for use in cast iron wheels and less for steel wheels, a greater taper being liable to start a crack in the wheel or cause it to come loose. This may be obtained without delaying the output. When these micrometer measurements are taken, the average diameter should be chalked on the axle for the benefit of the workman mounting the wheels, as will be explained later. The above limit of .004 in. can readily be obtained with lathes in a fair state of repair. Unfortunately, the wear on axle lathes is large, especially on account of the burnish wheel which naturally throws a heavy strain on the shears of the lathe and causes them to wear over the space the carriage travels. This wear can to a certain extent be equalized by shifting the tailstock, thus making

the error the same at each end. A lathe on which wheel seats are turned at either end which has become so worn that a taper in excess of .004 in. is obtained throughout a cut should be repaired, as a greater taper is liable to cause a loose or cracked wheel.

Lathe centers should be kept in proper shape and should be ground to an angle of 60 deg. or to a standard center gage. It is essential that all railway shops maintain this angle. Car axles go from one road or shop to another for repairs and the general appearance of the centers in many axles indicates that the question of lathe centers has not been given enough attention. Unfortunately double end lathes have two dead centers, therefore, the centers cannot be ground in place by portable center grinders. Therefore, other methods should be followed such as grinding them in tool room grinders, etc. It should be remembered by all who turn axles that an axle being turned on poor, rough, or improper shaped lathe centers may ruin the centers in the axle and cause it to run out of true when being returned, thus making it necessary to turn off an excessive amount of metal to true it up.

WHEEL BORING

Wheels are generally bored on special wheel boring mills having massive chucks for the clamping wheels. The adjustable boring bar having a micrometer dial for setting the cutters to various diameters is now becoming quite popular and possesses many advantages. Where the ram travel will admit, double cutter bars are used, having one set of cutters near the end of the bar and the second set some seven or eight inches above. With the latter, the lower cutters are used for roughing and the upper cutters for finishing. By this method one set of cutters can be kept sharp for the finishing cut. It is generally the custom to insert a tool at the extreme upper end for slightly counterboring the wheel, which is helpful when mounting.

When axles have been measured with micrometers as described above, a memorandum is made of the axle wheel seat sizes and posted on the boring mill. The boring mill operator then bores the wheels a certain amount smaller than the diameter of the wheel seats. For steel wheels this averaging about .001 in. for each inch diameter and some .002 in. for cast iron wheels.

When rough boring, the cutters are set about .04 in. small by the micrometer dial on the bar for the average machine. For a mill in a good state of repair and where the bar is very rigid this can be reduced. It is essential, however, that the finishing cutters remove enough metal to true up all surfaces of the hole. After the roughing cut is taken, the finish cutters are set to the exact diameter required and the finish bore is taken, after which the hole is measured, and, if correct, the size is chalked on the wheel. When mounting a wheel on an axle the micrometer sizes chalked on the axle and the wheel indicate the wheel for each wheel seat. With fair adjustable boring bars having micrometer dials, an average workman will bore 90 per cent of the wheels to within .001 in. of the size called for.

The methods explained above have many advantages over the older methods where solid cutters were used in the boring bars and where it was necessary to turn each wheel seat to a certain diameter to fit the wheel bore. When turning new axles it requires a high grade workman to turn each wheel seat to an exact size, say to a limit of .001 in. It is more economical to turn axles to a limit of say .010 in. over or under size, as this can be done easily and a larger output will be obtained from the axle lathes. The wheels can then be bored to suit with the aid of the adjustable boring bars. The operation of setting the cutter in boring bars is confined to turning the setting screw and micrometer dial to the required figure.

For repaired axles it is essential that the smallest amount

of metal be turned from the axle in order to prolong its life, the practice being to simply true up the axles without regard to size, and bore the wheels to suit. With the adjustable boring bar and micrometer measurements this can be done without any delay to the output. When considering the fact that the average axle can only be reduced in diameter about $\frac{1}{4}$ in. it is true economy not to turn away more metal than necessary. With axles at normal price, each .001 in. diameter is worth about four cents. Just now the cost is very much in excess of the above.

GRINDING AXLES

The question of grinding car axles has been discussed pro and con by makers of grinding machines and railway people and has gone so far that the Norton Grinding Company made a special grinding machine for this purpose. This machine employed a grinding wheel with an 8-in. face. This was fed directly onto the journal or wheel seat and had no lateral motion. Where the journal was longer than the face of the wheel, the grinding wheel was shifted by a hand control wheel, similar to the usual plan on grinding machines. The wheel was then fed in a second time and the axle ground until the second cut was equal to the first. This could be readily ascertained by sparks being thrown from the surface previously ground. On the completed surface it was impossible to detect the line between the two surfaces ground. The fillet was provided for by rounding the corner of the grinding wheel to the same radius as the fillet. This was done by a radius turning diamond holder and was made in a very short time. It would appear difficult to maintain a true surface on a grinding wheel having an 8-in. face; however, with the modern grinding wheel methods of manufacture, it was found that the face would remain true for several axles and that the time required to true wheel with a diamond was not a serious consideration.

The future of the grinding machine for car axles is hard to predict. Without a doubt the average work turned out is better than by present methods. But the present methods appear to meet the requirements. For new axles it is not practical to grind to the finish size without previous turning to about 1:32 in. above size. This will require the axles being handled twice. For repaired axles, grinding apparently has the advantage that a smaller amount of metal will be removed from the axle. This may result in a saving that will make grinding very attractive.

EXPLODED REAMER

Engineering of London in its June 22 issue prints an interesting letter from Conrad F. Mendham regarding the explosion of a 12-in. reamer of 1.840 in. diameter. The reamer was made for a special job and very carefully finished, but was found to be a trifle too small in boring its first and only hole. It was then repacked in the original oil paper, brown paper and corrugated strawboard in which it was received and placed in an empty drawer. Three weeks later the drawer was opened and the reamer was found in two pieces, lying about 3 ft. apart. A small third piece was found inside the package. Both the brown and oiled paper were badly torn and in the case of the latter a large portion was reduced to pieces about $\frac{1}{4}$ -in. square. The steel was of good quality and the fracture shows a clean, new, honest break, resembling the feather figure usually seen in ice blocks. The area of the fracture was 24 sq. in. Mr. Mendham states, "Without taking into consideration the greatly increased tensile strength due to hardening, the internal stresses tending to burst the bar may easily have been over 1,000 tons. It is curious that this tool, made for boring out mold shapes for forming up high explosive material, should have itself exploded before doing any useful work."

bushing shown in the illustration at *A* is placed in the hole, being held in position by the collar *B*, secured by a set-screw. The swivel *C* is then slipped into the bushing *A* and the guide *D* is placed through the hole in *C* with the offset downward, and held in position by the set-screw in *C*. The fork *E* is placed on the end of the guide, extending upwards. The torch is set in position with the tip extending downward through the hole in the end of the guide, and

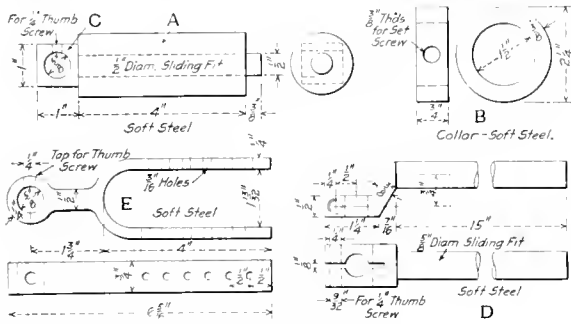

Device for Grinding an Oxy-Acetylene Torch When Cutting on a Circle

clamped by a thumbscrew. The handle is supported by a pin placed through a hole in the fork *E*.

The guide is adjusted to cut about three-eighths inch inside the marked line, and the cut is started at the three-fourths inch hole. The holes are finished as is usual on the horizontal boring machine. This device has been found to save considerable time as compared with the method of boring the holes on a drill press.

AND THEN THE WORM TURNED

BY HARVEY DEWITT WOLCOMB

"And finally," continued the young man, "you recognize the fact that when you buy any piece of material from a private firm, you certainly must pay them a profit on the article. But with my system, I propose to save that profit for your company by manufacturing right in your own shops. No doubt, you have some machines at the various shops on your road which can be spared, in fact, I feel there are some machines which are not in use at all, and by moving this machinery to some one point, you have the beginning of a manufacturing plant which means the saving of thousands of dollars to your company. By manufacturing yourself, you save the delay in purchasing in the open market, you save the profit made by the private concerns, and you place your production on a basis where your own shop management is responsible for the output. They can handle the supervision of the plant at no added cost to you, and the only increased cost of which you would be aware is my salary."

The general manager looked at the young man who sat opposite him in his office, with a look of admiration for the very able manner in which he had just presented his case. The G. M. was known from one end of the road to the other as a "war horse" of the old school, and it was understood that any one who could slip anything by the "Old Man" was certainly pretty slick. He was raised in the school of railroading where the man who held the important and dignified position of general manager was looked upon as almost equal to the Supreme Being. When any man entered his august presence it was with a very profound feeling of his own insignificance; thus all the "Old Man" had to do was to roar and the subject in his presence either swallowed his tongue or had a case of heart failure, and there was no further argument. But here was a young man who appar-

ently knew what he was talking about, for he had his facts and figures all arranged to a nicety, and did not hesitate at any of the questions the "Old Man" fired at him, so he must certainly be able to deliver the goods. The arguments he presented were very plausible and convincing, and for once the "Old Man" was nearly caught. As he turned the matter over in his mind, however, he began to wonder why his own mechanical officers had never proposed such a plan. He felt that his mechanical department included some of the brightest men in the field, and in the past they had always seemed to be up to date—in fact, had made several records in economical management which he had been justly proud of. There must be a loophole somewhere, and he decided not to take any action without first giving his own men a chance.

Turning to the young man who had been patiently waiting his decision, the G. M. said that while the plan just presented looked very good, it would be necessary to look into the matter very carefully before signing a contract, and thus closed the conference.

Thus was laid the foundation for the "turning of the worm." As is usually the case, John Gillen, machine shop foreman at Grants, the largest shop on the system, was one of those overworked, underpaid mechanics, who are really responsible for the good, everyday records in shop production, but for whom very little consideration is ever shown.

Shortly after the above conference was held, the general foreman asked Gillen one day how much he could save if he had some more machines. Instantly, John had visions of at last receiving the few new machines for which he had been plugging for the last three years, and mentally began to rearrange his shop to receive them, and to select the work he would assign to them. His vision was soon shattered when the general foreman told him of the plan of which he had just heard. "Somebody has been stuffing the 'Old Man' on the manufacturing idea," said the general foreman, "and he has about made up his mind to try the scheme at this shop by gathering up all the old cast-off machines along the line and putting them in the right wing of your machine shop so that you can look after the work."

"Don't fool yourself about anybody stuffing the G. M.," said Gillen, "he knows better than to try any idea like that. Didn't he tell you himself that for any railroad to run their own foundry was a waste of money, and isn't that just as much a manufacturing proposition as making up parts in our machine shop? I suppose some 'bug' has discovered that we are not efficient and wants to practice on us. Now, if you really want to save some money for this company, just make up a requisition for that new radial drill and those two planers I need, and I will show you how to save on our every-day jobs. Why, I haven't a single tool in the shop that has been built since we adopted high-speed tool steel."

"Yes, I know," quickly replied the general foreman, who knew what to expect when Gillen got started on his hard luck story about the kind of machine tools he had to get along with. So he beat a hasty retreat while the way was yet open.

Now, under a gruff exterior, the general manager always respected and appreciated true loyalty on the part of his employees, and he had often been much annoyed and not a little hurt, when approaching an employee whom he knew to be a good man, to have him slip through a door or around an engine in order not to have to pass him. Whenever he visited Grants shops, he always liked to go over the place alone in the morning, before the day's work had begun.

Not long after the idea of establishing a manufacturing department had been suggested to the general manager he came face to face with John Gillen, while making one of his early morning visits to the Grants shops. Much to his surprise John did not try to dodge him, but came straight

up to him as if he intended to start the conversation. In the past the general manager always had literally to corner John before he could hold him long enough to get anything out of him. "Mr. Allen," began John, "I have been working for you a good many years, and have never had any reason to think that I have not made good, and yet, every time I want simply to move a machine the matter has to be taken up before a committee, none of whom knows as much about what I need as I do. I am the man on the ground all the time and can study my conditions better than some one who comes here only occasionally. A person speaks with authority because of his ability. His ability is recognized because of his records, and I guess I have been with you long enough to establish records to prove my value to your company. The other day I made a request to turn a lathe to a slightly different angle because the light shone on the workman's eyes. I simply wanted to move the machine a little to improve conditions for the operator, and in turn increase the amount of work he could turn out. But what happened? The committee came over to investigate the need of the change, and because it happened to be a cloudy day they turned my request down as unnecessary. The reports which I make deal with conditions, not theories, and I only want a chance to prove to you that the best investments are made on knowledge acquired by thorough experience.

"And I don't get any better results when I ask for the new machine tools, which we need so badly at Grants. How long would you keep your train dispatchers if they put one of our big 'hogs' on a two-car train, and then expected one of our little eight-wheelers to haul a long, heavy freight train over the road? That is just what I have to do every day here in our machine shop. I use old, antiquated machinery, which was built before some of our locomotives were; in many cases I have to handle a small job on some big awkward machine, simply because I haven't any machine of the right size to use. You have purchased heavier locomotives and immediately arranged to lay heavier steel and strengthen bridges on which to run these big engines, but here in the shop, you have given us more powerful tool steel and expect us to get out the full amount of work it is capable of doing by using it in the same old light machines. You wouldn't place one of these old boilers, such as were built 20 years ago, on a modern locomotive, because it couldn't make enough steam, yet you expect us to keep up with our work, which is always growing heavier and larger in amount with our old equipment.

"Well, John," replied the G. M., for once in his life at a loss for an argument with which to silence Gillen effectively, "just what do you want?"

Although Gillen was so nervous that his knees were shaking, he came right back at the G. M.

"To begin with," he replied, "I want a planer that will take a cut at least one and one-half inches deep with a one-eighth inch feed, and will wade right through the cut without a whimper. We have one planer here that will stand all we can give it, but I have so much work for it that it never gets a chance to breathe. We need new lathes, a new drill press and some grinders." John got so wrapped up in his pet subject that he forgot himself entirely and asked for enough machines to equip his entire shop. Finally, he reached the point where he was unable to think of anything he had left unprovided for, and stopped for breath.

"Now, see here," replied the G. M., "one trouble with you fellows is that when you ask for anything, you ask for so much that you are way out of reason. I feel confident you need some new machines, yet from your own account I am unable to say just how many. But I am going to leave the matter entirely in your hands, and I want you to go over the ground carefully, make up a list of just what you need and I will arrange with your master mechanic to order what you say is actually required."

"Remember," continued the G. M., "this is a matter entirely between you and me. I will answer for any request you may care to make, and I am depending on you to be absolutely fair in what you ask for. While the railroad would like to give you an entire new plant here, you want to remember there are other fellows who are probably just as bad off as you are. Don't forget to say just what make of machine you want, for I intend to see you through this deal, if it is the last thing I do." Before John could say another word, the G. M. moved off, leaving him to wake up to a realization that the G. M. was human, after all, and open to a reasonable business proposition from one of his own men.

Shortly after this, as the general manager O. K.'d a special requisition for machine tools, he could not help but recall his conversation with Gillen; and to identify this one requisition, should any question ever arise as to why the road should purchase a new planer, a new radial drill and two new lathes, he wrote up in one corner: "And then the worm turned."

REPAIRING MAIN AND SIDE RODS*

The operations in repairing rods are much less complicated than manufacturing new ones. First, it is necessary to mark and check them according to the number of the engine, clean each of them thoroughly, dismantle, straighten, re-fit, renew such parts as cannot be repaired and re-tram. Such as are not in accord with the original cards are altered to conform thereto.

Repairing is one branch of the business and manufacturing new rods is altogether another. A gang brought up

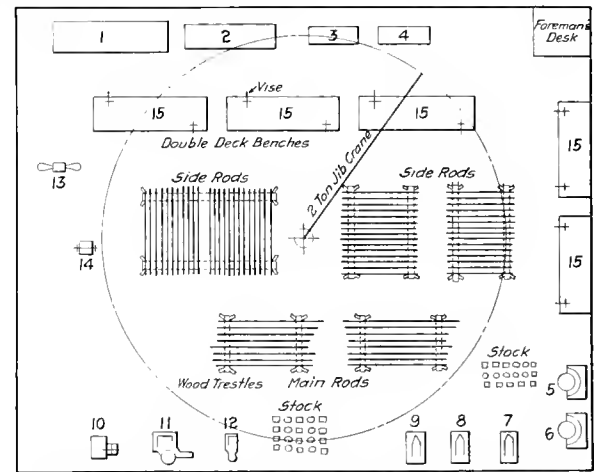

Arrangement of Machine Tools for Handling Rods for a Shop Output of Eight to Ten Locomotives per Week

- LIST OF TOOLS
- 1—Lathe—28 inches by 8 feet
 - 2—Lathe—18 inches by 6 feet
 - 3—Lathe—18 inches by 6 feet
 - 4—Lathe
 - 5—Vertical Turret—30 inches
 - 6—Vertical Turret—34 inches
 - 7—Shaper—24 inches
 - 8—Shaper—24 inches
 - 9—Shaper—24 inches
 - 10—Power Press—25 tons
 - 11—Radial Drill—5 feet
 - 12—Radial Drill—42 inches Upright
 - 13—Grinder—Swing
 - 14—Grinder—dry
 - 15—5 Benches

on repairs only may in time become as proficient as the gang handling new work, but rarely can this be reversed. The various ways for handling repair and new work are also different. Men accustomed to do nothing but new work seldom, if ever, became expert at repairing. It calls for a different variety of resourcefulness.

The size of a rod corner depends upon the number of

* This article was received with no letter of transmittal from the author. We shall be glad to learn from whom it was sent.—EDITOR.

locomotives to be cared for. Good men and a few stout, well-designed tools can accomplish a vast amount in this department. The description which follows is for a shop capable of handling for general repairs eight to ten engines per week in connection with the building of one new engine per week.

An essential requirement in any modern shop and especially a rod corner, is an overhead crane. It is possible to get on without it, but very inconvenient. Handling heavy material is awkward and dangerous. When done by hand, it often results in permanently maiming some employee. In planning this department some attention should be given to the movements of material so as to have it make as few moves as possible. All movements should be forward so that the rods will advance step by step towards the final spot to which they have been assigned. The machines necessary for repairing rods are lathes, shapers, heavy and light drills, vertical turret mills, power press, grinders and benches. Good, strong vises and a full equipment of small tools should also be provided, especially air drills, hammers, jacks and chippers. The illustration shows the arrangement of machine tools in the rod corner, the size and list of the tools being shown below it. In addition to these tools, the following tools not located in the rod corner proper are used a portion of the time for new rod work and for repairing old rods:

- | | |
|-----------------------------------|---|
| 30-in. by 30-in. by 10-ft. planer | 60-in. vertical milling machine |
| 32-in. by 38-in. by 10-ft. planer | 38-in. by 38-in. horizontal milling machine |
| 18-in. slotter | 50-in. horizontal boring mill |

A rod corner properly laid out and equipped should be able to take care of every detail in connection with the manufacture and repair of rods after the heaviest machine work, such as milling, sawing and slotting, has been done in the main shop. Few, if any, railroad shops have independent rod departments such as the large locomotive builders have. It would mean a big outlay of money and much idle machinery. The average shop must of necessity plan for its machinery so as to be of general use. A row of solidly constructed wooden top tables, about 30 in. high, makes a most serviceable and convenient fitting up bench. They should have large, strong drawers with locks and a lower deck for storing bolts, clamps and rigging of all kinds for doing the regular and special jobs and to keep such work off the floor. The placing of the machines as shown in the illustration is so that the fitters may be served from one side with the heavy parts such as bushings, bearings and straps, and from the lathes on the other side with pins, knuckle washers, keys, bolts and all small parts.

torily, though not quite so quick in its movements. Not many rod corners are adaptable to such a crane as this but where there is sufficient clearance no better arrangement can be designed and none can surpass it for general all-around usefulness. It will easily supplant several husky helpers. The heaviest main rod may be easily handled by one man and with less liability of accident than if it were handled by laborers. The swinging grinder is also useful, as it has a broad sweep and flexible construction, so that nearly every condition may be met. Bushings for knuckle pins and rod connections are made from special steel pipe, bored, turned to size, hardened and then pressed into place. This is a very simple and inexpensive practice, which allows the original holes to be maintained always to standard sizes. This department should be planned with special reference to daylight. If artificial light must be used, have it in abundance. Nothing is more exasperating to the ambitious mechanic than to struggle with darkness while trying to do a good job and a full day's work. Many a rough job is made rougher due to poor lighting facilities.

One very important point in the design of locomotive main and side rods is to keep the number of shapes to the minimum. Milling cutters are expensive tools to manufacture and maintain, so also are taps and reamers. By neglecting this, it is astonishing how these tools and templates may multiply, while with the exercise of a little skill in designing, these details may be reduced to a comparative few. Rod radii, for example, in a majority of cases may be made to conform to the nearest stock milling cutter, likewise cutters for fluted sections and the adoption of a standard taper for knuckle pins, bolts, keys, will require but few tools of this nature. Interchangeability will count for much here and effect a considerable saving in a short time. When there is no real object to be gained, rods should be kept the same length center to center—it will help to reduce the variety of billet sizes—and in emergency they may be transferred from one engine to another of the same general class and size. The length of rod center should always be in even dimensions—omitting fractional parts of an inch.

JIG FOR REBORING COMPOUND AIR COMPRESSOR CYLINDERS

BY EDWIN F. GLASS

The sketch below shows the details of an angle plate made from 3/4-in. boiler steel used for reboring the cylinders for locomotive air compressors of the 8 1/2-in. cross com-

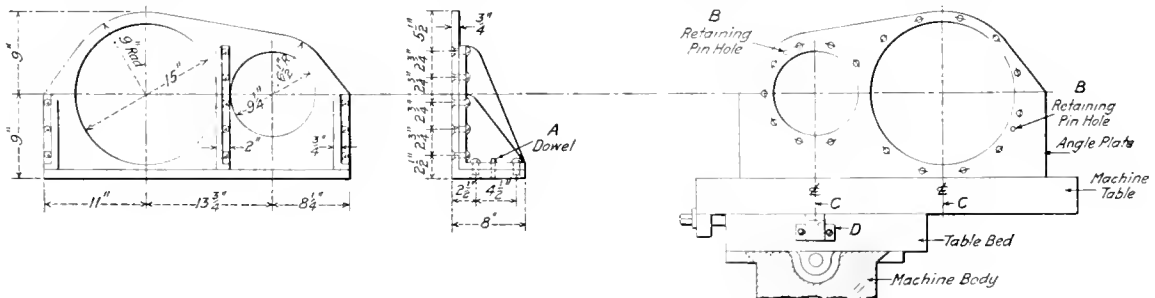

Jig for Reboring Compound Air Compressor Cylinders

A post gib crane with sufficient lengths of boom to swing clear and sweep the entire floor space, handles everything within a radius of 20 ft., approximating 1,200 sq. ft. of floor space. On this boom there should be a hoist of 1 1/2 to 2 tons capacity. It may be operated by power, but a triplex geared hand power block will serve very satisfac-

tory on a horizontal boring machine. This angle plate is bolted to the table of the machine, and is held in place by two dowel pins, shown at A. The cylinder to be rebored is bolted to the face of the angle plate, and is brought to the correct position for boring each time it is applied to the angle plate by having the retaining pins in the ends

of the cylinders fit into holes in the angle plate, shown at *B*. Two center lines are scribed and marked with a center punch on the side of the machine table, as shown at *C*. These lines are $13\frac{3}{4}$ in. apart, the exact distance between the centers of the cylinders, and are drawn in an exact line with the center of the cylinders.

The table bed is fitted with an iron block, shown at *D*, which is bolted to the table bed with two $\frac{3}{8}$ -in. bolts, and held in place by two dowel pins. At the top of this block there is a zero mark, and when the table of the machine is drawn to the center of the cylinder, the line on the block registers correctly with the line on the table. In laying off the holes in the angle plate to correspond with those in the cylinder, care should be taken that the lug or bracket on the back of the cylinders is about $\frac{1}{8}$ in. above the face of the machine table, this is to allow for irregularity in measurements from the center of the cylinder to the face of the bracket.

This device can be constructed at a small cost, and it will be found to save time in doing the work and give more accurate results. The principal advantage of this device is that the cylinders are always bored true with the face, and that the distance from center to center of the cylinders is also maintained. There is no necessity for resetting after reboring one cylinder; simply draw the table to the other center line and change the heads on the boring bar. When setting up a cylinder, line up under the brackets on the cylinder and place a clamp on each end. This will hold the work more rigidly.

BALL BEARING PIPE CENTER

BY E. A. M.

A ball bearing pipe center, which has been found very useful where it is necessary to turn or thread pipes on a

finished length of $9\frac{7}{8}$ in. and a diameter of $3\frac{13}{16}$ in. at the largest portion. A ball race is cut as indicated for 23 steel balls. The ball cup 2, is also made of axle steel, being provided with a flange over which the retaining ring 3 is applied. This ring screws on to the large diameter of the body. When once the ring is adjusted it is held in position by a set screw, a piece of copper being applied at the end of the set screw to prevent damaging the threads on the body.

The outer end of the body is turned to $1\frac{3}{8}$ in. diameter. Over this is placed the brass bushing 5 which has a sliding fit on the body and revolves on it. It is held in place by a knurled brass nut 4, $1/64$ -in. play being allowed between the nut and the bushing. The tapered center on which the pipe rests fits over the bushing and revolves with it and the ball bearing cup 2.

The ball bearing feature of this pipe center is especially interesting and has given very satisfactory results and the closeness with which the adjustments may be made, permits an accurate center being obtained. The small passage in the body of the center leading to the ball race is for proper lubrication.

FLAT PUNCH FOR AJAX BOLT MACHINE

BY C. W. SCHANE

A punch for forming flat keyway holes in brake pins and spring equalizers, which effects a material saving in the amount of tool steel used and in the cost of the punch, has been developed for use with the Ajax bolt machine and is shown in the drawing. The punches formerly used, which are the type furnished with the machine, cost not less than 75 cents each, there being a considerable amount of machine work in finishing them for service as well as a waste of tool steel.

The new punches are drop forged in a special die under the steam hammer, scrap pieces of tool steel being used. All the labor which is required to fit the punches is to grind off the burr left by the forging, the pieces then being ready to temper. The cost of manufacturing the punches will not exceed eight cents apiece. The method of inserting and holding the punch in place will be seen clearly by an inspection of the drawing.

In manufacturing the punches originally used, the steel is

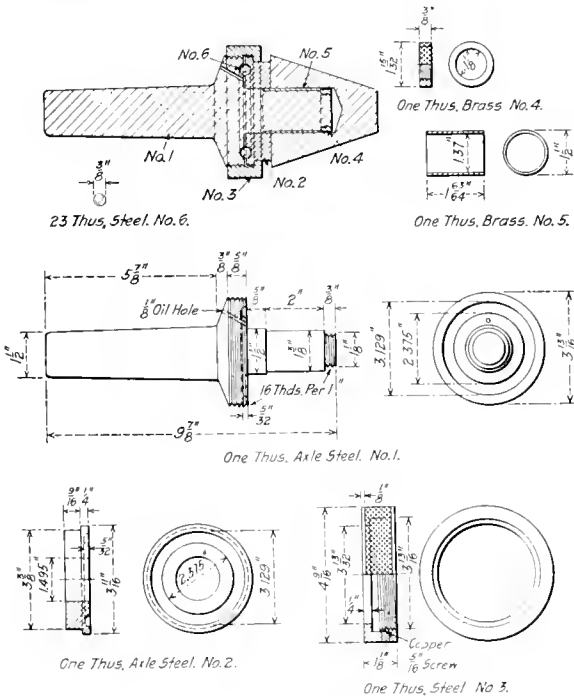

Ball Bearing Pipe Center

lathe, is shown with its details in the illustration. It consists of a body *I*, the shank of which is tapered to suit the tailstock of a lathe. It is made of axle steel and has a

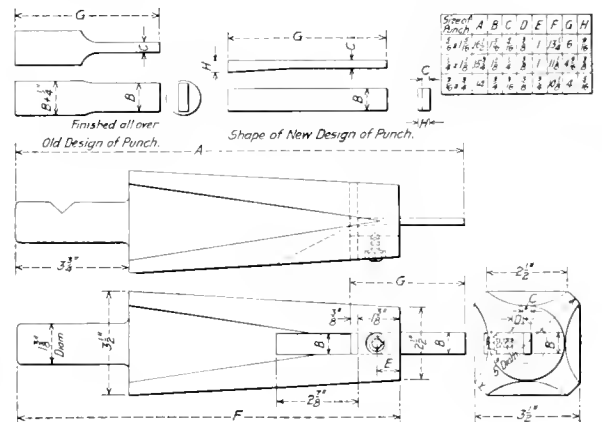

Flat Punch Designed to Save Tool Steel

first cut to length and then annealed for machining. It is then centered and turned in a lathe, after which the sides and edges are milled to the proper dimensions. The milling operation reduces the material from a body $\frac{3}{4}$ in. in

diameter to blades measuring 3/16 in. by 3/4 in. thick for the smaller size and in proportion for the larger sizes.

ALLIGATOR POWER SHEARS

BY J. H. CHANCY

Foreman Blacksmith Shop, Georgia Railroad, Augusta, Ga.

The drawings show a home made power shear which was built in the Augusta shops of the Georgia Railroad to replace an old pneumatic shear, by the use of which a great increase in the capacity for cutting up material has been

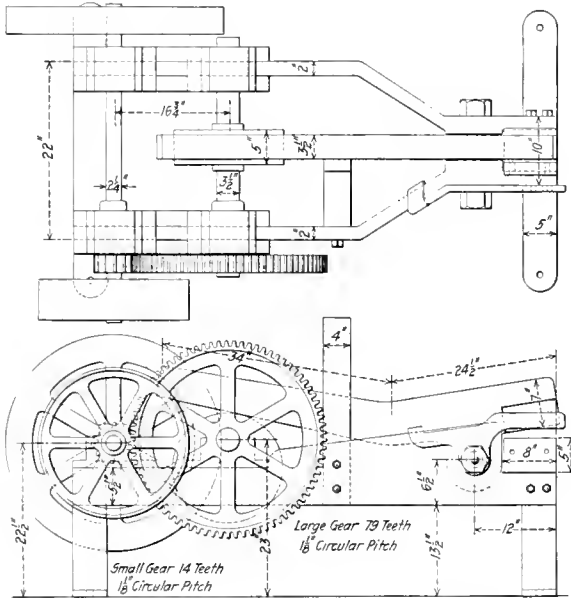

A Simple Shop Made Power Shear

effected. The capacity of the machine ranges up to 2-in. round and 3/4-in. by 4 1/2-in. rectangular sections.

The machine was built at the shops at a total cost not exceeding \$300. The frame was made from heavy iron beams of 2-in. by 12-in. section which were available and

some of the parts were designed especially for this machine. As will be seen by an inspection of the drawings, the movable shear plate is operated by a cam on a 3 1/2-in. shaft.

While, no doubt, a machine could have been purchased in the market which would possess some advantages over the one described, the service which this machine is rendering is entirely satisfactory and its construction was taken care of without interfering with the regular work of the shop.

NORTON JACK TRUCK

BY CHARLES W. SCHANE

A truck that is used by the truck and spring rigger men to handle two Norton jacks in and about a roundhouse or car yard is shown in the illustration. The work of these men generally requires the use of two jacks and by handling them in this way considerable time is saved, as they are always ready to be carried directly to the work. The truck is so designed that the jacks may be chained to it, and where the jacks are assigned to special workmen they are locked to the truck and held for their particular use. The device may be handled by one man.

The illustration shows clearly the construction of the truck. It is made up principally of bar iron, the tongue being 5/8 in. thick and 3 in. wide. The braces extending from

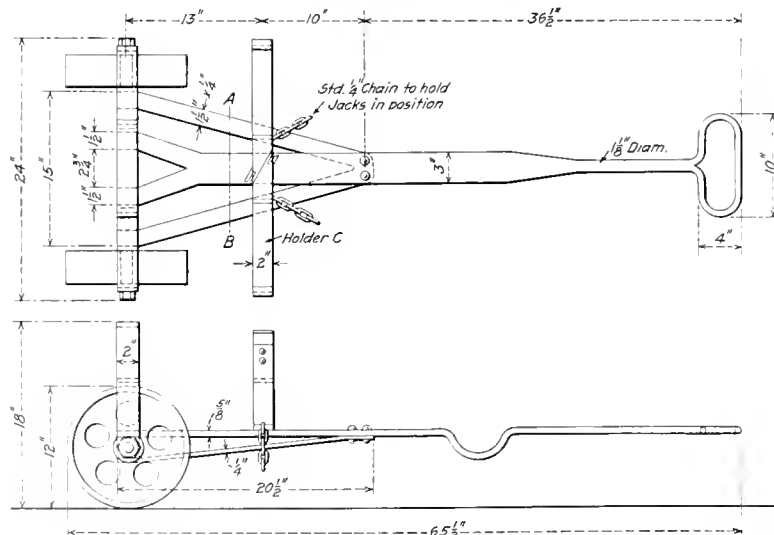
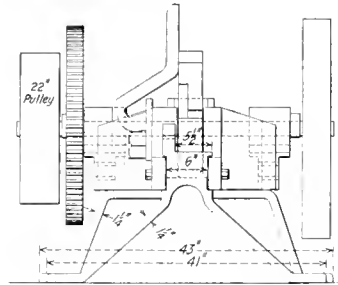

Truck for Carrying Norton Jacks

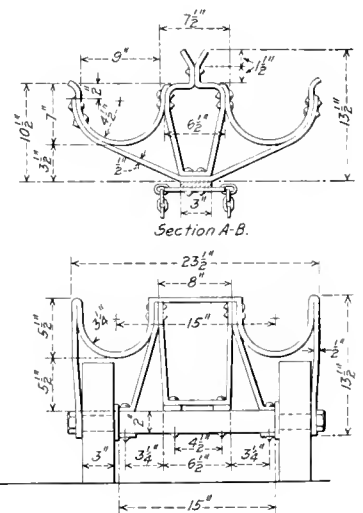



APRON FOR HEAVY DUTY LATHES

The apron is the most complicated part of the feed mechanism of a lathe and in the apron the greatest strains are encountered. In an ideally designed lathe, the apron should be strong enough to force the carriage along the guides at any rate of feed and depth of cut which the headstock will pull and yet in the apron the greatest number of limitations and restrictions are imposed upon the design.

The apron shown in the photographs has been designed

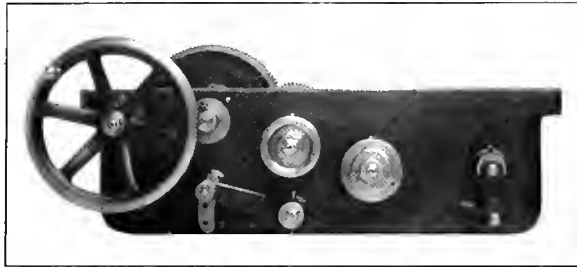

Front of the Lathe Apron

by the Houston, Stanwood & Gamble Company, Cincinnati, Ohio, and with slight modifications, depending upon the size of the machine, is being used on all of this company's standard engine lathes, varying in sizes from 30 in. to 60 in. inclusive. The design of this apron includes a number of features which give it unusual driving power, structural strength and durability.

The gears are of steel without exception, this material

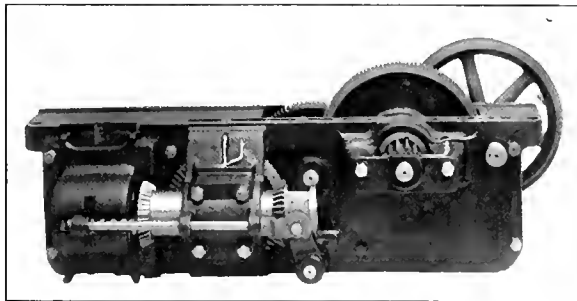

Back of the Apron, Showing Rack Pinion with Outer Bearing Support

having been used in order that these parts may be able to stand up under the sudden and unusual strains imposed by unduly heavy cuts or other accidents not infrequently met with. Friction clutches have long been a source of annoyance because of their tendency to slip on the one hand and because of the difficulty of releasing them on the other. In

this design the friction clutch has been replaced by the positive toothed clutch, the disks in the initial drive being connected by a shearing pin. This type of clutch, of course, does not slip and because of the slight pressure required to hold the clutch closed, it is very easily released. The shearing pin provides a weak point which protects the feed mechanism from damage should the carriage be accidentally fed against the tailstock, headstock, steady rest, or any other obstruction. The clutch for the cross feed is attached to the carriage and is not shown. However, this is a positive toothed clutch, similar to that in the initial drive.

By referring to the photograph showing the back side of the apron, the broad face and coarse pitch of the rack pinion will be noted. This pinion and shaft are so arranged that it may be withdrawn from the rack for thread cutting. One of the especially noteworthy features of the design, is the provision of an outer bearing for the rack pinion, which is usually overhanging. The large bevel gear in the initial drive is also provided with an outer bearing, but this is not shown in the illustration.

The bearings in the rear of the apron are oiled by means of a capillary wick system which can be seen in the photograph. The reverse lever for shifting the double bevel gear is of the usual type and it will be seen that the nut for the lead screw is opened and closed in the usual manner.

VESTIBULE TRAP DOOR LOCK

In the June 14, 1916, issue of the *Daily Railway Age Gazette*, was published a description of the Universal trap door which was manufactured by the Transportation Utilities Company, in connection with which was shown a special type of door latch and wedge lifter. A new type of door

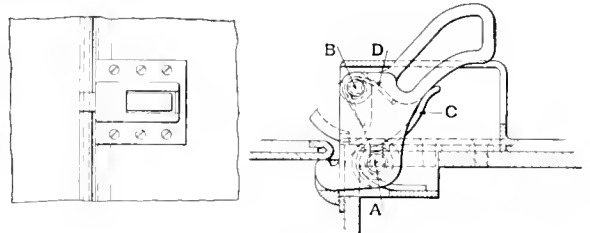

Foot-Operated Trap Door Latch Which Insures the Opening of the Door

latch, which performs the same functions of latch and lifter, has recently been developed, for use with this and the National trap door, by the Tuco Products Corporation, New York, successors to the Transportation Utilities Company. This latch is much simpler than the one previously described, being foot operated and self contained.

By referring to the drawing it will be seen that the moving parts consist of the foot release lever, the latch and two springs. The release lever, which is pivoted at A, contains

the latch and latch spring *D*. The latch is pivoted at *B* and when the trap door is closed, is forced back to permit the door to pass, against the tension of the latch spring. As soon as the door closes, the spring again forces the latch out to the position shown in the drawing. In opening the door, the latch itself is not moved. By stepping on the foot lever it is forced down against the tension of spring *C*, carrying back the latch with it, the whole moving about the pivot *A*. As the upper end of the lever is forced down by the foot, the lower end of the lever, which extends under the edge of the trap door, moves up, thereby starting the door. This serves to insure ready operation of the door, should it become frozen or stick from any other cause.

The design of the foot lever is such that no special care is required in its operation as a downward pressure exerted on it with the foot, no matter at what angle it may be applied, serves to operate it. The operator is thus enabled to so place himself that his leg will not be struck by the edge of the door as it swings up.

NEW AJAX FORGING MACHINE

Large forging machines have found use on railroads for the economical production of heavy parts such as draw-bars, side rods and eccentric cranks. Machines of more than 6-in. capacity have not been available for this work, although special machines of larger size have been built. To meet the demand for large forging machines the Ajax Manufacturing Company, Cleveland, Ohio, has put on the market a 7-in. forging machine. This machine is the heaviest and largest forging machine ever built.

The first 7-in. forging machine was built in 1911 and since that time a number of special machines have been con-

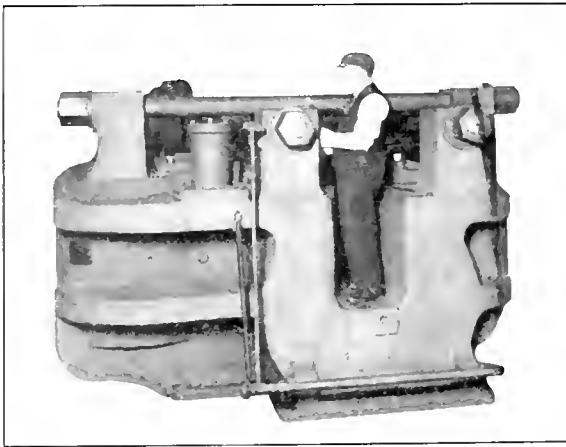

Front View of the Ajax 7-in. Forging Machine

structed. These had a single toggle operating the movable die, while the present design has a double toggle. The standard machine is also heavier than the earlier design. The complete machine with its regular equipment weighs nearly 100 tons. The bed plate casting is of steel 21 ft. long and 9 ft. 6 in. wide and weighs about 60 tons.

The 7-in. machine is built along the lines of the smaller Ajax up-setting machines. The crank shaft housings are continuous, being bored large enough to take the throw of the crank. The bronze bushed bearings are pressed into the bed from each side forming solid bearings for the crank shaft. The clutch mechanism is located between the main slide and pitman, and in this way the momentum of the crank shaft and pitman are utilized. As the clutch can only pick up the main slide and start it in motion at the end of

a stroke, the action is very easy and a minimum of power is used in starting the machine in motion. The side motion of the moving die is operated through a set of knuckles from the main slide in such a way that the dies are closed when the heading tool is about half way forward and remains closed until the heading tool is back to the same

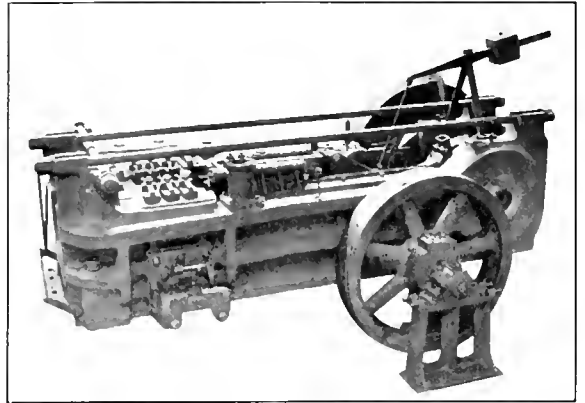

Ajax 7-in. Forging Machine

point. This insures the heading tool being free from the forging before the grip is released. Liners may be used in the die seat to accommodate smaller blocks when light work is being done on the machine.

WATER GAGE GLASS GUARD

The Simplex Safety Boiler Gage Glass Company, Myrick building, Springfield, Mass., has recently placed on the market a gage glass guard, the purpose of which is to protect

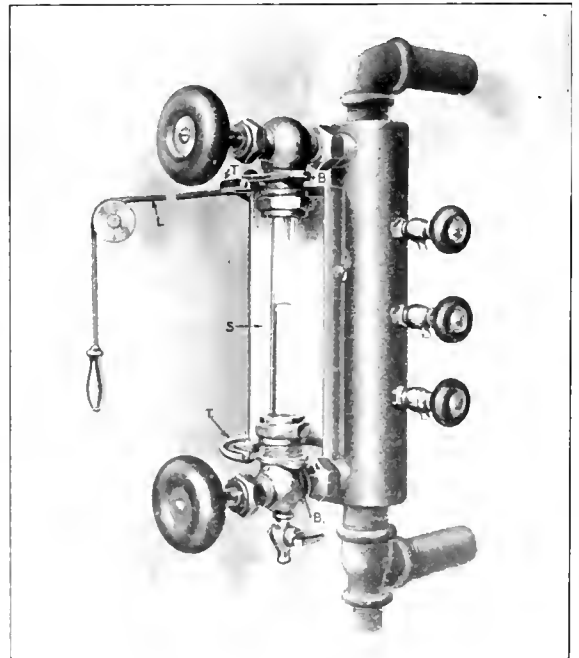

Simplex Gage Glass Guard

the workman when shutting off the gage glass valves when a glass has become broken. It consists of a semi-circular

shield as shown in the illustration, which operates in circular tracks at the top and bottom. A cord attached to this shield and carried to some convenient part of the boiler room remote from the glass is used to operate the shield in the curved tracks. Whenever a glass becomes broken, the shield may be pulled around in front of the glass, thus deflecting the steam and water away from the handle of the valves, enabling them to be closed without danger to the workman. By pulling the shield still further around it will be removed from the tracks, thus giving an unrestricted opportunity for installing a new glass. Before the valves are again opened, the shield is put in its protecting position. This is done to prevent accident in case the new glass should break. When it has been determined that the glass has been properly applied, the shield is turned back to its original position. The interior of the shield is so finished that the water level may be easily read in the glass. The device is of simple construction and can be mounted on the gage rod brackets of any water gage.

THREAD LEAD INDICATOR

The Bucknell-Thomas Company, Greenfield, Mass., has recently placed on the market a simple and inexpensive but accurate device for testing the lead on screw threads, both external and internal. The illustrations clearly show the construction and method of using the instrument for measur-

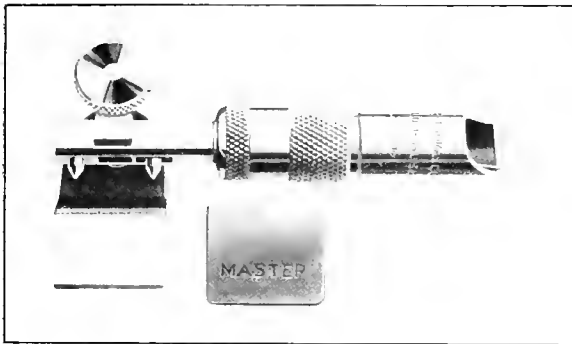

Bucknell-Thomas Thread Lead Indicator

ing the lead on both the screw and inside the tapped hole. In use, the tool is held in one hand, preferably the left, and the screw is pressed against the two points which are spaced 1/4 in., 1/2 in. or 1 in. apart, as desired. If the lead of the

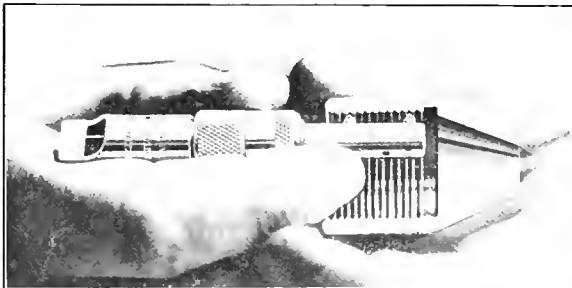

Testing an Internal Thread for Lead

thread is normal the indicator needle will register at zero; if the lead is short the needle will show on the minus side; if long, on the plus side. Each line of the graduation represents .001 in.

The little table on which the screw rests in testing is easily adjusted to any height to accommodate screws of any dia-

meter. For internal measuring the table is removed merely by loosening the thumb screw and drawing it off. The end of the instrument containing the point is small enough so that tapped holes, as small as 1/2 in. in diameter, can be tested and of course from that up to any size. This is a feature which is of the utmost importance in making sure that the

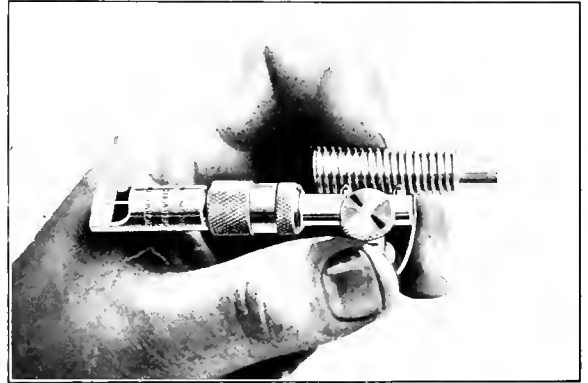

Application of the Thread Lead Indicator to Screws

lead of the thread on both the screw and in the tapped hole are the same.

A master is furnished with each gage so that the operator may be sure at all times that the needle point is on zero when the gaging points are spaced correctly. If it is necessary to test threads with odd pitches, such as 13 threads to the inch, a master gage can be furnished to which the indicating point can be adjusted.

JIG FOR USE IN UPSETTING AXLES AND DRAWBARS

A jig for use in reclaiming tender axles and engine and tender drawbars has been developed and patented by J. J. Lynch and H. Pfluger at the St. Paul shops of the Chicago, St. Paul, Minneapolis & Omaha, the use of which reduces the labor required to a minimum. But a few minutes are required for the performance of the work, aside from the time

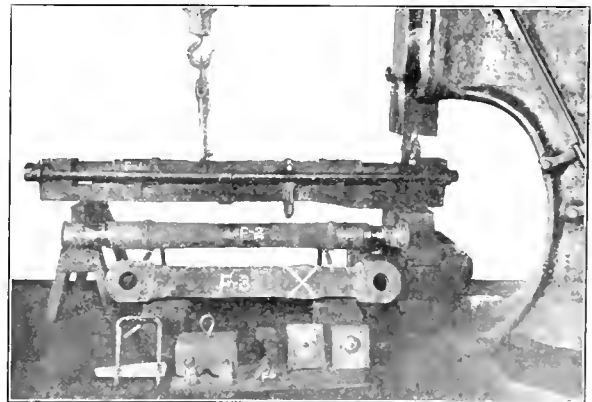

Jig and Tools for Upsetting Drawbars and Axles Under the Steam Hammer

in the fire. The jig consists of a heavy bar with shoulders at either end, the face of one being vertical, and the other oblique. To increase the stiffness of the device, the shoulders are tied together with heavy rods.

As shown in the photograph, the jig is being used for the reclamation of a worn axle. After one end of the axle has

been heated, it is placed in the jig with the cold end against the vertical shoulder and a wedge is driven down between the heated end and the oblique shoulder under a steam hammer. This upsets the end of the journal, reducing it in length about one inch, the amount required at either end to reduce the length to that required for the next size smaller. The practice is to convert worn axles with 5½-in. by 10-in. journals to 5-in. by 9-in. journals, and the latter when worn to 4½-in. by 8-in. journals, two operations being required for each axle.

Engine and tender drawbars from large power come to the shop frequently to be shortened and to have worn holes rounded up. In doing this work, the end of the bar is heated, after which it is placed in the jig. The tool designated *F 6* in the photograph is then placed against the hot end of the bar and the wedge shown at *F 10* is driven down under the steam hammer. This closes the eye of the bar and the hole is then rounded up by driving through it a pin of the proper size. The entire operation requires about five minutes.

The holes in both ends of the bar shown in the photograph have been rounded up, and in addition the bar has been heated and shortened in the body, reducing it in length two inches.

In performing the operations, both on axles and drawbars, three men are required. Two helpers place the piece in the jig, the blacksmith holds the wedge in position and the steam hammer drives it home. The tools *F 4*, *5* and *6* are used in shortening and closing the holes in the ends of drawbars, *F 5* being adjusted on the jig to suit the varying lengths of the bar. The tools shown at *F 7* and *8* are used when upsetting the ends of axles; *F 8* is used in the first operation on the axle, spreading the stock radially at the extreme end of the journal and centering the axle at the same time. Tool *F 8* is then removed and replaced by *F 7*, which smooths up the end of the axle and leaves ample stock for the collar of the returned journal. A clamp shown at *F 9* is used to hold the work in position in the jig.

INSULATION FOR PASSENGER CAR FLOORS

A mineral insulating material for use in passenger car floor construction, which somewhat resembles wool felt in appearance and texture, has recently been placed on the

which is melted and blown into a mineral wool. This in turn is mixed with a liquid binder, the mixture being poured into containers of proper depth, depending upon the thickness of insulation desired. These containers have a wire mesh bottom through which the liquid is permitted to drain off, the solid material settling on the screen in sheets, the thickness of which depends upon the depth of the liquid mixture in the tank. After draining, the material is placed in drying ovens where all the moisture is evaporated, the material in its final form being made up of 85 per cent to 90 per cent enclosed air cells.

Being of mineral structure, the insulation is fireproof and tests have shown that it is practically waterproof. After being submerged in water for a period of one hour, the material shows a gain in weight of only one per cent. The material is light and is manufactured in the form of blocks or sheets which are quickly and easily applied. A cement is furnished with which the blocks are secured to the sheets on which they rest and with which all joints are sealed.

SPECIAL TIP FOR CUTTING RIVET HEADS BY THE OXY-ACETYLENE PROCESS

For cutting off rivet heads and stay-bolts flush with plates, by the oxy-acetylene process, it is desirable to have a cutting tip so designed as to permit the gas jet playing parallel with the plates. To meet this need the Prest-O-Lite

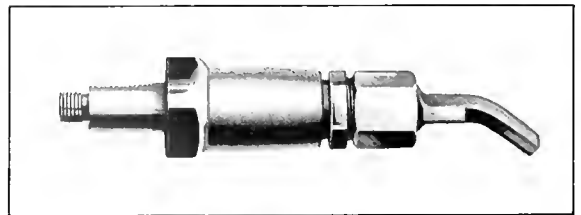

Special Tip for Cutting Rivet Heads by Oxy-Acetylene Process

Company, Inc., Indianapolis, Ind., is manufacturing a special rivet and stay-bolt cutting attachment. This attachment is used in connection with the Type *K* cutting blow-pipe being screwed into the head in place of the regular cutting nozzles. The copper tip is bent at a convenient



Tucork Floor Insulation in Place

market by the Tuco Products Corporation, New York. This material, which is marketed under the trade name of Tucork, is manufactured from a material secured in rock form,

angle and is adjustable to any position, facilitating operation in close quarters.

Much cleaner work in rivet and stay-bolt cutting is pos-

sible with this attachment than with standard cutting tips which do not permit making a cut truly parallel with the plates.

KEROSENE ENGINE FOR McKEEN MOTOR CARS

The McKeen Motor Car Company, Omaha, Neb., has developed a method for using kerosene instead of gasoline as fuel in its railway motor car engines. Cars operating with this fuel have been in use for about two months and the results are reported to be satisfactory in all respects. The use of kerosene effects a saving of 74 per cent of the cost of fuel as compared with gasoline and a reduction in the cost of operation per train-mile of 31 per cent. There is no appreciable increase in the cost of maintenance, a little more attention from the motorman being all that is required. The successful use of kerosene is the result of a series of

means of regulating the quantity as well as atomizing the fuel make it possible to secure the proper explosive mixture under all conditions. To avoid undue complications in control the engine is started on gasoline and after it is in motion kerosene is substituted. The trouble which is sometimes encountered with the lubrication of internal combustion engines using kerosene has been satisfactorily overcome.

The first car equipped to use gasoline was a steel passenger car weighing 65,000 lb. It has a 200-horsepower, 6-cylinder engine, of the variable speed type. At the present time it is in branch line local passenger service, making an average of 210 miles a day. Since kerosene has been substituted for gasoline on this run there has been an increase of from 25 to 50 per cent in the mileage per gallon of fuel. The power developed on grades is materially increased and the motorman has expressed satisfaction on account of the greater ease in making the scheduled running time. It is felt that the slight additional complication of parts and the increase in

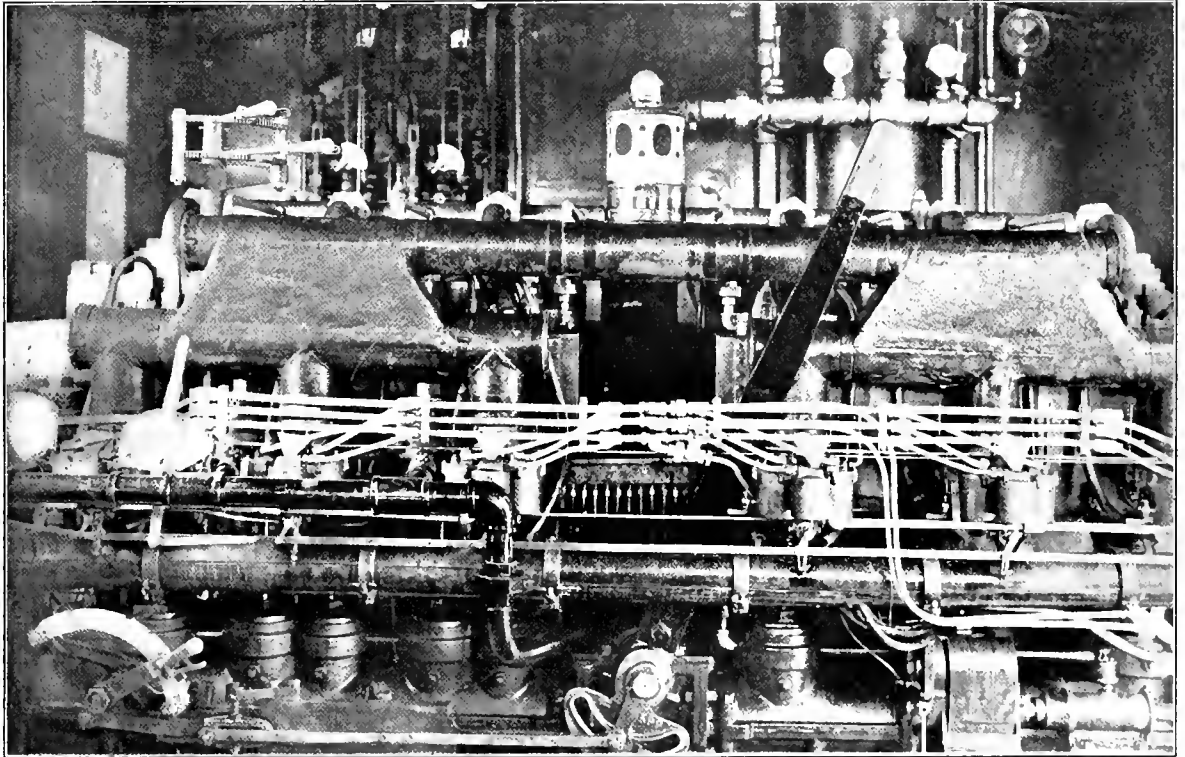

McKeen Motor Car Engine Which Uses Kerosene as Fuel

experiments carried on during the past five years by this company. Various grades of distillate have been used for about two years and the latest developments have made it possible to go a step farther and utilize kerosene. The operation of kerosene carburetors was found to be unsatisfactory. In the present design one carburetor of the multiple jet type is applied to each cylinder. The kerosene is atomized and delivered to the cylinder with a mixture of tempered air, there being eight nozzles for each cylinder. When running light only one nozzle per cylinder is used, the others coming into action when the throttle is opened. Through the use of one carburetor for each cylinder the manifold has been eliminated. The supply of hot and cold air can be regulated and for use on heavy grades water jets are provided. Kerosene does not mix with air as readily as distillates or gasoline, but the use of tempered air and mechanical

the cost of the apparatus is insignificant as compared with the economy which has been obtained by the use of kerosene.

LACK OF LUBRICANTS IN GERMANY.—Press despatches from London, reported under date of April 30, that when application was made in the prize court on that day for condemnation of several shiploads of lubricating oils and fats as enemy property, counsel read an affidavit from a member of the war trade intelligence department in which it was stated that latest reports in the hands of the government showed that 8,000 locomotives were laid up at Essen alone in March on account of wear and tear caused by the scarcity of lubricating oils in Germany or by the employment of bad lubricants. The lubrication of railway engines was said to be one of the pressing problems in Germany. (There were something over 30,000 locomotives in Germany before the war.)

Railway Mechanical Engineer

(Formerly the RAILWAY AGE GAZETTE, MECHANICAL EDITION
with which the AMERICAN ENGINEER was incorporated)

PUBLISHED ON THE FIRST THURSDAY OF EVERY MONTH BY THE
SIMMONS-BOARDMAN PUBLISHING COMPANY

EDWARD A. SIMMONS, *President* L. B. SHERMAN, *Vice-President*
HENRY LEE, *Vice-President and Treasurer* M. H. WILM, *Secretary*
WOOLWORTH BUILDING, NEW YORK, N. Y.
F. H. THOMPSON, *Business Manager*, CHICAGO.

Chicago: Transportation Bldg. Cleveland: Citizens' Bldg.
Washington: Home Life Bldg.
London: Queen Anne's Chambers, Westminster.

ROY V. WRIGHT, *Editor*
R. E. THAYER, *Managing Editor*
C. D. PECK, *Associate Editor* A. F. STUEBING, *Associate Editor*

Entered at the Post Office at New York, N. Y., as mail matter of the
second class.

Subscriptions, including the eight daily editions of the *Railway Age Gazette* published in June in connection with the annual conventions of the Master Car Builders' and American Railway Master Mechanics' Associations, payable in advance and postage free: United States, Canada and Mexico, \$2.00 a year; Foreign Countries (excepting daily editions), \$3.00 a year; Single Copy, 20 cents.

WE GUARANTEE, that of this issue 9,000 copies were printed; that of these 9,000 copies 7,930 were mailed to regular paid subscribers, 112 were provided for counter and news companies' sales, 292 were mailed to advertisers, 100 were mailed to exchanges and correspondents, and 476 were provided for new subscriptions, samples, copies lost in the mail and office use; that the total copies printed this year to date were 72,747, an average of 9,083 copies a month.

THE RAILWAY MECHANICAL ENGINEER is a member of the Associated Business Papers (A. B. P.) and the Audit Bureau of Circulations (A. B. C.).

According to a recent announcement of the Chicago & North Western, 79 employees have entered army or navy service. There have been enlistments from practically all departments.

As the result of a movement instituted by employees of the Chicago Great Western, \$1,640 was recently collected and sent to the Great Western company of the Thirteenth Engineers, then stationed in Chicago, to provide greater comforts for the men. R. B. Parrott, passenger conductor, was chairman of the employees' committee which handled the contributions, and George Bristow, assistant general passenger agent, Chicago, was secretary.

The Louisville & Nashville has made arrangements to buy a large quantity of goggles to supply every man in its shops in Kentucky. If the men do not wear the glasses, after the employer furnishes them, they must themselves bear the risk of injuries, which could have been prevented by wearing glasses. Under the Kentucky Workmen's Compensation law credits are given on the basic risk rates on liability insurance where employers adopt safety first measures. One of these credits is in connection with the furnishing of goggles.

The Pennsylvania Railroad has decided to suspend, temporarily, the regulation covering the age limit for employment. The rule heretofore in force prohibited the hiring of new employees in any branch of the service, above the age of 45 years. Under the new rule, which has been adopted to meet war conditions, persons between the ages of 45 and 70 years may be employed during the war and for a period of six months thereafter. Such employment is not to be considered permanent, and it will not carry with it the privileges of the pension department. Numbers of former employees have already been taken into the service.

Samuel M. Felton, president of the Chicago Great Western and heretofore adviser to General Black, chief of engineers of the United States army, has been appointed by the Secretary of War director general of railways, with office at Washington, D. C. According to the order announcing his appointment, Mr. Felton is charged under the chief of engineers with the organization and despatch abroad of all railway forces and the purchase of all railway material, both for initial action and for continuous supplies for operation. Mr. Felton has been in charge of the organization of the railway engineer regiments for service abroad.

The Thirteenth Engineers (Railways), United States

Army, has moved to the Atlantic seaboard on its way to France. Two companies started on July 18, and the remainder of the contingent on July 21. All of the nine railway regiments organized under the direction of S. M. Felton, president of the Chicago Great Western, were recently renamed and renumbered, ten having been added to each of the former numbers. For example, the regiment until recently stationed at Chicago and formerly known as the Third Reserve Engineers, is now the Thirteenth Engineers (Railways), United States Army. Before leaving their quarters on the Municipal pier at Chicago, the Thirteenth Engineers (Railways), United States Army, were presented with regimental colors by S. M. Felton, president of the Chicago Great Western, and C. H. Markham, president of the Illinois Central.

A controversy between the railroads and the shopmen employed on the southeastern railroads, involving about 25,000 men, who demanded an increase of 10 cents an hour and an eight-hour day, has been referred to the United States Department of Labor for mediation, with an agreement on the part of both the employers and the men to abide by the decision of the Secretary of Labor in case the conciliators of the department are not able to effect a settlement. The railroads offered increases amounting to six cents an hour, with an eight-hour day, for about 90 per cent of the men involved, but this was not accepted by the men and a strike had been called, to become effective July 12, when the mediation agreement was reached. The wage increase will amount to about \$1,000,000 a year, for the roads involved, for each cent per hour.

J. A. F. Aspinall, general manager of the Lancashire & Yorkshire, is now a knight, that honor having been conferred on him by King George on his last birthday. Mr. Aspinall is a member of the Railway Executive Committee now managing the railways under the war regime. He was born in 1851. He was educated at Beaumont college, Berkshire, and his first railway service was in the shops of the London & North Western at Crewe. From 1875 to 1886 he was a shop superintendent on the Great Southern & Western of Ireland. In the last named year he went to the Lancashire & Yorkshire as chief mechanical engineer and he has been with that company ever since. The extensive shops of that company, at Horwich, were laid out under his supervision. He was appointed general manager in 1899. In 1907 he was chairman of the general manager's confer-

ence at the Railway Clearing House, and in 1909-1910 he was president of the Institution of Mechanical Engineers.

A. J. Earling, president of the Chicago, Milwaukee & St. Paul, has presented a copy of Elbert Hubbard's "Message to Garcia" to each of the members of the St. Paul company of the Thirteenth Engineers (Railways), who will leave for France this summer to operate railroads at the front. On the cover of the booklet is a print of the American flag in colors, under which is the following quotation from President Wilson's war message: "The world must be made safe for democracy. Its peace must be planted upon the tested foundations of political liberty." The text is prefaced by Mr. Earling's own message to the men: "In wishing the officers and employees of the Chicago, Milwaukee & St. Paul God-speed as they depart for the front, it is my sincere wish that each and every one may have the opportunity of delivering that message to Garcia and safely return to the happiness of his home with the consciousness of having been ready and a realization that the hero of the war was the man who delivered the message when called upon."

Car and Locomotive Orders in July

Of the 518 locomotives reported in July, 400 were on government orders, 300 for the United States Government and 100 for the British Government. During July also, the order was signed for the 500 Russian Government Decapod locomotives, but these are not included in the July totals because they were included in June. The 300 locomotives for the United States Government are 80-ton Consolidation locomotives for service with our own forces in France. The order was divided evenly between the American Locomotive Company and the Baldwin Locomotive Works. Those to be built by the former are duplicates of the locomotives now on order for the French State Railways. Those to be built by the Baldwin Locomotive Works are to be similar to the British Government locomotives some of which were recently delivered.

The orders were as follows:

	Locomotives.	Freight Cars.	Passenger Cars.
Domestic	415	5,570
Foreign	103	1,200
Total	518	6,770

The important locomotive orders included the following:

Atebison, Topeka & Santa Fe.....	100	Baldwin
United States Government.....	150	Consolidation American
.....	150	Consolidation Baldwin
British Government.....	100	Consolidation Baldwin

Among the important freight car orders were the following:

Canadian Government Railways.....	1,000	Box	National
Grand Trunk.....	1,000	Box	Am. E. & F.
Pennsylvania R. R.....	2,000	Box	Altoona
.....	100	Flat	Altoona
.....	100	Cabin	Altoona
.....	25	Well	Altoona
Union Railroad.....	1,500	Coke	Kalston

Pennsylvania Electric Locomotive

In the article describing the Pennsylvania's new electric locomotive which was published in the *Railway Mechanical Engineer* of July, on page 379, the fact that the electrical equipment was supplied by the Westinghouse Electric & Manufacturing Company, Pittsburgh, Pa., was omitted through oversight. This company provided the motors and all electrical apparatus used on this locomotive.

How Long Is a Long Time ?

The following statement, given out by one of the eastern roads, calls attention to the far-reaching effects of its heavy curtailment of passenger service:

"The New York, New Haven & Hartford, which has taken off 199 passenger trains, is thereby saving, each week, 2,054 tons of coal, equal to an annual saving of 106,828

tons. As two tons of coal will warm a family of five persons a long time, it is estimated that by reason of this economy of train service nearly 270,000 persons could be kept comfortable during the coming winter."

Women on the New York Central

Women have made "a splendid start" on the New York Central, according to a statement made by an officer of the road. A gang of thirty women, under direction of a woman bookkeeper, is employed at Collinwood, Ohio, in sorting 3,000 tons of scrap metal. They do the work as well as men, and appear to like it. The woman who does the same work as a man will get the same pay. Those women who are sorting scrap get an average of \$2.50 a day.

The number of women employed in the auditing department has been increased; and there are many in the car record office. Some are being trained in the purchasing department, to sell tickets, and to act as watchmen at railroad crossings. In the shops women are learning to run lathes, drills and other small tools, and women will be employed as assistants in stations. One woman has been in the service as watcher at a railroad crossing for the last ten years.

Vice-President A. T. Hardin says: "Our present work is centered largely in organization and training. The women we are training are in many instances relatives of our employees. Many women have extraordinary energy and power for constructive work, which has never been put to practical use. The war gives them an opportunity to serve their country and themselves."

MEETINGS AND CONVENTIONS

Railway Equipment Manufacturers' Association.—At a meeting of the executive committee of the Railway Equipment Manufacturers' Association at Chicago, June 11, the convention of the association for this year was canceled.

Master Car and Locomotive Painters' Association.—Owing to the state of war declared and now existing between the United States and Germany, it has been decided by the president and executive board that the forty-eighth annual convention of the Master Car and Locomotive Painters' Association of the United States and Canada will be postponed until further notice.

- The following list gives names of secretaries, dates of next or regular meetings and places of meeting of mechanical associations:
- AIR BRAKE ASSOCIATION.**—F. M. Nellis, Room 3014, 165 Broadway, New York City.
 - AMERICAN RAILROAD MASTER TINNERS', COPPERSMITHS' AND PIPEFITTERS' ASSOCIATION.**—O. E. Schlink, 485 W. Fifth St., Peru, Ind. Convention postponed.
 - AMERICAN RAILWAY MASTER MECHANICS' ASSOCIATION.**—J. W. Taylor, Karpen Bldg., Chicago. Convention postponed.
 - AMERICAN RAILWAY TOOL FOREMEN'S ASSOCIATION.**—R. D. Fletcher, Belt Railway, Chicago. Convention postponed.
 - AMERICAN SOCIETY FOR TESTING MATERIALS.**—Prof. E. Marburg, University of Pennsylvania, Philadelphia, Pa.
 - AMERICAN SOCIETY OF MECHANICAL ENGINEERS.**—Calvin W. Rice, 29 W. Thirty-ninth St., New York.
 - ASSOCIATION OF RAILWAY ELECTRICAL ENGINEERS.**—Joseph A. Andreucetti, C. & N. W. Room 411, C. & N. W. Station, Chicago.
 - CAR FOREMEN'S ASSOCIATION OF CHICAGO.**—Anton King, 841 Lawlor Ave., Chicago. Second Monday in month, except June, July and August, Hotel La Salle, Chicago.
 - CHIEF INTERCHANGE CAR INSPECTORS' AND CAR FOREMEN'S ASSOCIATION.**—W. R. McMunn, New York Central, Albany, N. Y. Convention postponed.
 - INTERNATIONAL RAILROAD MASTER BLACKSMITHS' ASSOCIATION.**—A. L. Woodworth, C. H. & D. Lima, Ohio. Convention postponed.
 - INTERNATIONAL RAILWAY FUEL ASSOCIATION.**—J. G. Crawford, 547 W. Jackson Blvd., Chicago.
 - INTERNATIONAL RAILWAY GENERAL FOREMEN'S ASSOCIATION.**—William Hall, 1126 W. Broadway, Winona, Minn. Convention postponed.
 - MASTER BOILERMAKERS' ASSOCIATION.**—Harry D. Vought, 95 Liberty St., New York. Convention postponed.
 - MASTER CAR BUILDERS' ASSOCIATION.**—J. W. Taylor, Karpen Bldg., Chicago. Convention postponed.
 - MASTER CAR AND LOCOMOTIVE PAINTERS' ASSOCIATION OF U. S. AND CANADA.**—A. P. Darg, B. & M., Reading, Mass. Convention postponed.
 - NIAGARA FRONTIER CAR MEN'S ASSOCIATION.**—E. N. Frankenberger, 623 Brisbane Bldg., Buffalo, N. Y. Meetings, third Wednesday in month, New York Telephone Bldg., Buffalo, N. Y.
 - RAILWAY STOREKEEPERS' ASSOCIATION.**—J. P. Murphy, Box C, Collinwood, Ohio. Convention postponed.
 - TRAVELING ENGINEERS' ASSOCIATION.**—W. O. Thompson, N. Y. C. R. R., Cleveland, Ohio.

PERSONAL MENTION

GENERAL

J. R. DWYER has been appointed fuel supervisor on the Louisiana division of the Texas & Pacific, with headquarters at Alexandria, La., succeeding D. H. Varnell, assigned other duties.

J. J. HANLIN, master mechanic of the Seaboard Air Line at Howells, Ga., has been appointed assistant superintendent of motive power, with headquarters at Portsmouth, Va.

H. H. MAXFIELD, superintendent of motive power of the New Jersey division of the Pennsylvania Railroad, has been granted a furlough to enter military service as an officer of the Ninth Engineers of the National Army, the Railway Shop regiment.

B. B. MILNER, engineer of motive power of the New York Central, at New York, has also been assigned the duties heretofore performed by the chief mechanical engineer, R. B. Kendig, deceased. The office of chief mechanical engineer has been abolished.

JOSEPH SLUTZKER, assistant master mechanic of the Altoona machine shops of the Pennsylvania Railroad, has been promoted to assistant engineer of motive power of the Western Pennsylvania division.

A. E. VOIGHT, assistant electrical engineer of the Atchison, Topeka & Santa Fe, has been appointed electrical engineer, with headquarters at Topeka, Kan.

F. G. GRIMSHAW, assistant engineer electrical equipment of the Philadelphia Terminal division of the Pennsylvania Railroad, has been promoted to superintendent of motive

power of the New Jersey division, with headquarters at New York, succeeding H. H. Maxfield. Mr. Grimshaw was born on November 26, 1878, at Paterson, N. J., and was educated at Cornell University. After serving for one year in the Cooke Locomotive Works, he entered the service of the Pennsylvania Railroad in 1902 as special apprentice in the Altoona machine shops. From 1905 to August, 1906, he served successively as yard clerk and assistant

yardmaster on the Pittsburgh division, and then was appointed assistant master mechanic of the Monongahela division. In June, 1907, he was appointed master mechanic on the West Jersey & Seashore, serving in that capacity until September, 1912, when he was appointed assistant engineer of motive power on the Western Pennsylvania division of the Pennsylvania Railroad at Pittsburgh, Pa. In November, 1914, he was transferred to Philadelphia as assistant engineer of electric equipment.

T. J. HAMILTON, district master mechanic of the Chicago, Milwaukee & St. Paul, at Tacoma, Wash., has been appointed assistant superintendent of the Missoula division, with headquarters at Avery, Idaho.

MASTER MECHANICS AND ROAD FOREMEN OF ENGINES

C. D. BARRETT, master mechanic of the Pennsylvania Railroad, at Sunbury, Pa., has been granted a furlough to enter military service as an officer of the Ninth Engineers of the National Army, the Railway Shop regiment.

A. H. BEIRNE, general roundhouse foreman of the Atchison, Topeka & Santa Fe at Albuquerque, N. M., has been appointed master mechanic of the Western division, with headquarters at Dodge City, Kan., succeeding Edward Norton.

ROBERT G. BENNETT, assistant engineer of motive power of the Central division of the Pennsylvania Railroad, has succeeded C. D. Barrett as master mechanic at Sunbury, Pa.



R. G. Bennett

Mr. Bennett was born at Brighton, England, on March 31, 1882. He entered the service of the Pennsylvania Railroad in 1900 as a machinist apprentice in the Erie, Pa., shops, completing his apprenticeship at the Renovo, Pa., shops four years later. He graduated from Purdue University in 1908 as a bachelor of science in mechanical engineering and in 1915 he was given the degree of mechanical engineer. While attending college, he worked during

the summer months as a machinist, draftsman and inspector and in November, 1908, was appointed motive power inspector of the Monongahela division. In March, 1912, he was transferred to the Pittsburgh division as rodman in the maintenance of way department, and a year later he became inspector in the test department at Altoona, Pa., being assigned to the locomotive test plant on bulletin work. In May, 1916, Mr. Bennett went to Chambersburg, Pa., as assistant master mechanic of the Cumberland Valley Railroad and returned to the Pennsylvania Railroad in February, 1917, as assistant engineer of motive power of the Central division at Williamsport, Pa.

G. E. CESSFORD, district master mechanic of the Chicago, Milwaukee & St. Paul, at Deer Lodge, Mont., has been transferred to Tacoma, Wash., succeeding T. J. Hamilton, promoted.

GEORGE C. CHRISTY, general foreman of the McComb shops of the Illinois Central, has been appointed master mechanic at Vicksburg, Miss., succeeding C. Linstrom, deceased. Mr. Christy was born at Water Valley, Miss., on December 7, 1882. He entered the service of the Illinois Central at that point on June 1, 1898, and worked consecutively as painter, machinist apprentice, machinist, roundhouse foreman, and erecting shop foreman, being appointed general foreman of the Water Valley shops in October, 1911. He was transferred to the McComb shops in December, 1914, as general foreman, in which capacity he served until his recent promotion.

F. P. McDONALD has been appointed master mechanic of the Stockton division of the Southern Pacific at Stockton, Cal., succeeding A. D. Williams, promoted.

W. R. MEEDER has been appointed master mechanic of the Illinois Southern, with office at Sparta, Ill., succeeding W. F. McCarrag resigned.



F. G. Grimshaw

C. S. GASKILL, master mechanic of the Pennsylvania Railroad at Orangeville, Md., has received a furlough to enter military service as an officer of the Railway Shop regiment, the Ninth Engineers.

D. J. McCUAIG, acting master mechanic of the Grand Trunk at Toronto, Ont., has been appointed master mechanic of the Ontario lines, with headquarters at Toronto.

H. L. NEEDHAM, general foreman of the locomotive department of the Illinois Central at Twenty-seventh street, Chicago, has been appointed master mechanic of the Springfield division, with headquarters at Clinton, Ill., succeeding William O'Brien, assigned to other duties.

C. D. RAFFERTY has been appointed master mechanic of the Algoma Central & Hudson Bay, with office at Sault Ste. Marie, Ont., succeeding Thomas Fraser, resigned.

F. S. ROBBINS, assistant master mechanic of the Pennsylvania Railroad, at Pittsburgh, Pa., has been granted a furlough to enter military service as an officer of the Railway Shop regiment, the Ninth Engineers.

EDWARD SCHULTZ, master mechanic of the Chicago & North Western at Chicago, has been recommended for first lieutenant in the Third Reserve Engineers.

HARRY S. SCHUM, general foreman of the East Altoona enginehouse of the Pennsylvania Railroad, has been appointed assistant master mechanic of the Altoona machine shops.

M. F. SMITH, district master mechanic of the Chicago, Milwaukee & St. Paul at Dubuque, Iowa, has been transferred to Milwaukee, Wis., succeeding A. Young, resigned to enter military service.

LEON A. STARKWEATHER, motive power inspector of the Pennsylvania Railroad, has been appointed assistant master mechanic of the New York division.

J. H. THOMAS, assistant general foreman of the Pennsylvania Railroad, at Pitscairn, Pa., has been appointed assistant master mechanic at Pittsburgh, succeeding F. S. Robbins.

G. H. WATKINS, assistant engineer of motive power of the Western Pennsylvania division of the Pennsylvania Railroad, has been appointed master mechanic of the Baltimore division at Orangeville, Md., succeeding C. S. Gaskill. Mr. Watkins was born on April 17, 1881, at Charlotte Court House, Va. He entered the Altoona shops of the Pennsylvania Railroad as a special apprentice on June 24, 1903, and was made an inspector on June 1, 1907. He was transferred to the Delaware division as enginehouse foreman on September 1, 1910, serving in that capacity until November of the same year when he was promoted to assistant master mechanic at the Meadows shops. Three years later Mr. Watkins was assigned to the Pittsburgh division and on November 1, 1914, he became assistant engineer of motive power of the Western Pennsylvania division.

ALEXANDER YOUNG, district master mechanic of the Chicago, Milwaukee & St. Paul at Milwaukee, Wis., has been recommended for a commission of captain in the Third Reserve Engineers.

SHOP AND ENGINEHOUSE

AMOS C. DAVIS, general foreman of the Altoona erecting shops of the Pennsylvania Railroad, has been appointed general foreman of the East Altoona enginehouse.

CHARLES W. DAVIS, assistant roundhouse foreman of the Atchison, Topeka & Santa Fe at Dodge City, Kan., has been appointed division foreman at Deming, N. M.

H. G. FLANDERS, roundhouse foreman of the Atchison, Topeka & Santa Fe, at Clovis, N. M., has been promoted to general foreman at that point.

LYLE H. GIBBS has been appointed general foreman of the Atchison, Topeka & Santa Fe at Shawnee, Okla.

WILLIAM GRUYS, general foreman of the Atchison, Topeka & Santa Fe at Waynoka, Okla., has been appointed general foreman at Wellington, Kan.

F. P. HOWELL, erecting shop foreman of the Atlantic Coast Line at Waycross, Ga., has been appointed general foreman at that point.

E. S. MEYER has been appointed gang foreman of the Waycross shop of the Atlantic Coast Line, succeeding H. C. Spicer, promoted.

FRANK E. MYERS, roundhouse foreman of the Atchison, Topeka & Santa Fe, at Waynoka, Okla., has been appointed general foreman at that point.

J. ORMSBY has been appointed general foreman of the locomotive department of the Illinois Central at Twenty-seventh street, Chicago, succeeding H. L. Needham.

SAMUEL R. PARSLAW, formerly general machine foreman of the Great Northern at the Dale street shops, St. Paul, Minn., and for the past two years engaged in mechanical valuation work for that company, has been appointed shop superintendent of the new shops at Great Falls, Mont.

H. C. SPICER, formerly gang foreman of the Atlantic Coast Line at Waycross, Ga., has succeeded F. P. Howell as erecting shop foreman of the Waycross shop.

PURCHASING AND STOREKEEPING

J. L. FEEMSTER, storekeeper of the Kansas City Terminal Railway at Kansas City, Mo., has been appointed general storekeeper of the Chicago Great Western, with headquarters at Oelwein, Iowa.

LEONARD L. KING has been appointed division storekeeper of the Illinois Central, at McComb, Miss., succeeding W. S. Morehead.

S. F. LANGTON has been appointed division storekeeper of the Atchison, Topeka & Santa Fe, at Seligman, Ariz., succeeding S. C. Fogarty.

AUGUST W. MUNSTER, whose appointment as purchasing agent of the Boston & Maine, with headquarters at North Station, Boston, Mass., was announced in these columns last month, was born on July 24, 1882, at Waltham, Mass. He was educated in the Massachusetts Institute of Technology, and in 1904 began railway work with the Northern Pacific, where he served as a machinist and material inspector. In 1909, he went to the New York, New Haven & Hartford as material inspector, and subsequently served as chief inspector and engineer of tests. In 1911 he went to the Boston & Maine as general storekeeper, which position he held at the time of his recent appointment as purchasing agent.

GEORGE W. RICE has been appointed division storekeeper of the Illinois Central, at Memphis, Tenn., succeeding L. L. King.

NEW SHOPS

UNION PACIFIC.—This road will carry out improvements during 1917 to include the construction of new shops, roundhouse facilities, coaling stations, etc., at Omaha, Neb., at a cost of \$3,000,000. Plans for this work have not yet been completed except for a new power house and extensions to shops at Omaha, to cost \$656,000.

NEW YORK CENTRAL.—A contract has been given to John W. Cooper & Co., Buffalo, N. Y., for building an enginehouse with turntable and annex buildings, in the freight yards at Gardenville, N. Y. The work calls for putting up a structure 35 ft. high, 100 ft. wide and 500 ft. long, with concrete foundations, and brick and timber super-structure. The approximate cost of the work will be \$150,000.

SUPPLY TRADE NOTES

Charles B. Yardley has been elected president of Steel & Iron Mongers, Inc., with offices at 796 Broad street, Newark, N. J.

At a meeting of the board of directors of the American Locomotive Company, held June 21, L. A. Larsen was appointed assistant comptroller.

A. D. Bruce, in charge of purchases and supplies for the Vapor Car Heating Company, Inc., Chicago, has been elected secretary and controller, succeeding Arthur P. Harper, resigned.

G. A. Cooper, representative in the railroad department of the United States Graphite Company, at Chicago, has been appointed advertising manager of the company, with headquarters at Saginaw, Mich.

H. G. Doran & Co., Peoples Gas building, Chicago, have been appointed selling agents for the Schaefer Equipment Company, Pittsburgh, Pa., manufacturers of the Schaefer truck lever connections.

The American Steel Foundries, Chicago, has purchased the Eclipse cast steel coupler yoke from the National Car Equipment Company. The Eclipse yoke requires neither keys nor rivets, and is now in use on a large number of railroads.

D. B. Mugan, who was formerly in charge of the electrical department of the Illinois Central at New Orleans, La., has been appointed resident manager of the Edison Storage Battery Supply Company, with headquarters at 201 Baronne street, New Orleans, La.

Willard Doud, consulting engineer, Old Colony building, Chicago, Ill., has closed his office temporarily, to accept a commission as lieutenant, junior grade, in the United States Naval Reserve. He has been assigned to active service at the Naval Training Station, Great Lakes, Ill.

At a meeting of the executive committee of the board of directors of the American Locomotive Company, held July 18, David Van Alstyne was appointed an assistant vice-president, in charge of manufacture. Mr. Van Alstyne has hitherto held the title of assistant to vice-president.

Charles S. Clark, formerly sales agent of the Pennsylvania Steel Company at Boston, Mass., has been elected first vice-president and general manager of the Laconia Car Company, and will make his headquarters at Laconia, N. H., where the business of the company will be transacted hereafter.

L. O. Cameron, formerly manager of sales in the southern district for the Pressed Steel Car Company, has opened an office in the Munsey building, Washington, D. C., and will hereafter represent the Pressed Steel Car Company, and the Oxweld Railroad Service Company. He will also handle government accounts.

The Lodge & Shipley Machine Tool Company, Cincinnati, Ohio, has elected the following new officers: M. G. Lodge, president; J. W. Carrell, vice-president and general manager, and L. A. Hall, secretary and treasurer. Murray Shipley has sold his entire interest in the company and has severed his connection with it.

Among those in the service of the American Steel Export Company, New York, who have been called to the colors, is K. G. Martin, manager of the service and publicity departments. Mr. Martin was granted an honorable discharge from the 22nd Regiment, Corps of Engineers, N. G., N. Y.,

in order to be able to accept a commission as captain, Officers' Reserve Corps, Motor Transport Service.

The Mark Manufacturing Company, Chicago, will spend approximately \$14,500,000 in the construction of a steel plant at South Chicago. This is \$9,500,000 in excess of the cost as estimated a year ago. The new plans provide for the construction of a 600-ton blast furnace, with docks, ore and coke handling machinery, which was not in the original plans. The new plans also provide for an open hearth steel department with a capacity of 250 gross tons of ingots per year.

Daniel A. Wightman, formerly general manager of the Pittsburgh Locomotive Works, died at Warren, R. I., on July 6. Mr. Wightman was born at East Greenwich, R. I., in 1846. He was educated in the public schools of that town, and after a course in an evening school in Providence, entered the employ of the Rhode Island Locomotive Works as a draftsman. In 1876 he went to the Pittsburgh Locomotive Works as superintendent. He later became general manager and held that position when he retired in 1902.

The Walter A. Zelnicker Supply Company, St. Louis, Mo., and affiliated companies are now represented in the Birmingham district by Thomas A. Hamilton, who for the past 14 years has been connected with the Crane Company, prior to which he was superintendent of the East St. Louis plant of the Zelnicker Car Works. Mr. Hamilton will have charge of both buying and selling in the southeastern district. His office will be at 1018 Woodward building, Birmingham, Ala.

The Walter A. Zelnicker Supply Company, St. Louis, Mo., announces the appointment of W. H. Dayton as city salesman. Mr. Dayton was formerly with the Railroad Supply Company, Chicago, as secretary and purchasing agent, and also eastern representative for five years. He went to St. Louis seven years ago, representing the same firm, the Chicago Signal & Supply Company, and the Elyria Iron & Steel Company, manufacturers of signal and track maintenance materials.

Roland C. Fraser, vice-president of the Buffalo Brake Beam Company at New York, died on July 17 at his home at Suffern, N. Y. He was born at Boston, Mass., on April

11, 1865. Mr. Fraser was widely known in the supply trade. He began his business career in the railway supply field by joining the business staff of the Railroad Gazette in 1890. After several years' service in that position he was employed, successively, by the Monarch Brake Beam Company, of Detroit; the U. S. Metal & Manufacturing Company, of New York, and the Buffalo Brake Beam Company, of New York. At the time of his death he



R. C. Fraser

was vice-president of the last named company and had been in its service for 14 years.

A gift of \$385 was recently made to the Thirteenth Engineers, United States army, by seven Chicago railway supply companies. Of this amount, \$85 was used to cover the expenses of a band, which furnished music during a review of the regiment on July 12, and the remaining \$300 will

be used to provide greater comforts for the men. The companies which contributed to the fund were the P. & M. Company, Robert W. Hunt & Co., the Railroad Supply Company; Fairbanks, Morse & Co.; the Rail Joint Company; the Galena-Signal Oil Company, and Pratt & Lambert.

Frank B. Bradley, vice-president of the Ajax Forge Company, Chicago, died at his home in Chicago, on July 14. Mr. Bradley was born at Lake Forest, Ill., on May 6, 1866, and entered the service of the Ajax Forge Company in 1884 as an office boy. With the exception of a few years' service with the Morden Frog & Crossing Works, the Buda Foundry Company and Clement Curtis & Co., he has been continuously with the Ajax Forge Company since that time, having special charge of the sales department in recent years. In addition to his sales duties he has invented and perfected several railroad track specialties.

The L. B. Stillwell Engineering Corporation has been organized to act as constructing engineer in the design and construction of steam and hydro-electric lighting, railway and power plants; electric transmission, electrification of railroads, the design and construction of steel rolling stock, railroad terminals, steam heating plants and general engineering construction work. The officers are: Lewis B. Stillwell, president; H. St. Clair Putnam, vice-president and general manager; Hugh Hazelton, vice-president, and W. Everitt Rundle, secretary and treasurer. The principal office of the corporation will be located at 100 Broadway, New York City.

Samuel Lindsay Nicholson, who has been sales manager of the Westinghouse Electric & Manufacturing Company since 1909, has been promoted to the position of assistant to

vice-president, with headquarters at East Pittsburgh, Pa. Mr. Nicholson was born in Philadelphia, received his education in the William Penn Charter School of that city and began his business career as an apprentice with the Belmont Iron Works in 1887. He entered the electrical business the following year and served with various electrical companies until 1898, when he became sales representative of the Westinghouse Electric & Manufacturing Company, in

New York. He subsequently had charge of the city and industrial division of the New York office. On the reorganization of the sales department in 1904, he was made manager of the industrial department, which position he filled until his selection as sales manager of the company in 1909.

David A. Munro, formerly manager of the J. N. Johns Manufacturing Company, has accepted a position with the Railway Specialties Corporation, New York, and will take active charge of that company's railroad department. Mr. Munro was born in Scotland. He came to this country in February, 1907, and in October of the same year entered the auditor's office of the Metropolitan Street Railway in New York. He was later assistant to the auditor of the Second Avenue Railroad of New York, and was shortly afterwards appointed purchasing agent to the receiver in addition to his other duties. On December 1, 1916, he resigned to enter the supply field as manager of the J. N. Johns Manufacturing Company.

W. G. Bee, vice-president and general sales manager of the Edison Storage Battery Company, Orange, N. J., died at his home in that city July 11, aged 48 years. Mr. Bee



W. G. Bee

was born in Hartford, Conn., on December 14, 1868. He left school at the age of 15 and enlisted in the United States Navy as seaman's apprentice. After four years' service he received an honorable discharge and returned to Hartford and became associated with the Pope-Hartford Bicycle Company, which later became the Electric Vehicle Company of Hartford. In this way Mr. Bee became one of the pioneers of the electric vehicle industry. In

the Spanish-American War, Mr. Bee was a chief gunner's mate on the U. S. S. "Gloucester," J. P. Morgan's yacht "Corsair." After the war Mr. Bee returned to the Electric Vehicle Company and spent some time in Mexico in its interests and was in charge of its exhibit at the Pan-American Exposition. In 1903, Mr. Bee became associated with Thomas A. Edison, then at Glen Ridge. When the Edison Storage Battery Company was organized in Orange, Mr. Bee became general sales manager, and in 1905 was elected vice-president.

Herbert Deeming, who has been appointed sales manager of Mudge & Co., with headquarters in the Railway Exchange, Chicago, was born in England on April 16, 1880. He began

his business career as a stenographer and clerk in the general passenger department of the Fremont, Elkhorn & Missouri Valley at Omaha, Neb., in October, 1897. From July, 1899, to September he was with the American Express Company at Omaha, and from the latter month until January, 1900, he was employed in the general superintendent's office of the Fremont, Elkhorn & Missouri Valley. He was then promoted to secretary to the general freight



H. Deeming

agent of the same road, and in July, 1902, went to Chicago, where he was employed in the auditor's office of the Chicago & Western Indiana. In January, 1903, he was promoted to a position in the president and general manager's office. From July, 1903, to February, 1916, he was secretary of the General Managers' Association, at Chicago, and from November, 1907, to February, 1916, was also secretary of the Association of Western Railways. In March, 1916, he became assistant director of the Railway Educational Bureau at Omaha, Neb., and seven months later he became associated with the H. E. Reisman Advertising Company, which position he held until his recent appointment.

W. F. Walsh, of the railway export department of the Galena-Signal Oil Company, has received a commission as

captain in the Engineer Reserves, United States Army. Mr. Walsh was formerly with the Chesapeake & Ohio, and while with that company held a commission as first lieutenant of the Roanoke Blues of the Virginia National Guard.

L. C. Sprague, formerly general motive power inspector of the Baltimore & Ohio, with headquarters at Baltimore, has been appointed special representative on air brake specialties for the general railroad department of the H. W. Johns-Manville Company, with headquarters in New York. Mr. Sprague has been in railway service since 1899, serving on the Chicago, Burlington & Quincy from that time to 1910 as fireman, engineman and then fuel inspector. In 1912 he became a locomotive and air brake instructor for the International Correspondence Schools, following which he was assistant general air brake instructor on the Great Northern at St. Paul. He became general motive power inspector of the Baltimore & Ohio in 1915.

Oden H. Wharton, formerly assistant to the president of the Crucible Steel Company, has been elected president of the company. Mr. Wharton was born at Easton, Pa., and received his schooling at that place. His first business association was with Park Brothers & Co., Ltd., at that time operating the Black Diamond Steel Works in Pittsburgh. He started as office boy, then became billing clerk and finally a salesman. Later he was connected with the sales department of the Park Steel Company in Cleveland and other cities. He went to Boston for some years as representative of the Park Steel Company, and later of the Crucible Steel Company of America, and was finally appointed general manager of sales of the latter company, with headquarters at Pittsburgh. After holding this position for several years his health failed, and he was succeeded by Reuben Michener, the present general manager of sales. Mr. Wharton traveled in Europe for a year or more, and, regaining his health, was appointed assistant to President Charles C. Ramsey, of the Crucible Steel Company, who died recently.

The Automatic Straight Air Brake Company

The Automatic Straight Air Brake Company of New York during the next few weeks will send out invitations to many of the leading railroad officers of the country to witness the operation of the automatic straight air brake, on a 100-car test rack at New York, and shortly thereafter to attend the road service trials, which will be conducted by the Division of Safety of the Interstate Commerce Commission.

The company has leased a building in which it has installed a 100-car test rack, which includes the complete car equipment arranged with full length train line and all other piping, just as it would be applied on a 100-car train. The apparatus for each car includes a trainagraph with three recording pens indicating respectively the pressure of the brake cylinder, the auxiliary reservoir and the train line. An observer can thus see at a glance just what takes place on each car in the train.

During the fall of 1915 this brake was tested in road service on the Atchison, Topeka & Santa Fe, under the supervision of the Division of Safety of the Interstate Commerce Commission, and since that time the improvements suggested by the commission in its report to Congress in June, 1916, have been made in the equipment. The principal features of the brake, an early form of which was described in the February, 1915, issue of the *Railway Age Gazette, Mechanical Edition*, page 92, are the use of wing valves, the movement of which is controlled by diaphragms under the action of differential pressures and the use of train pipe air for the service application of the brake, making possible the maintenance of a predetermined brake cylinder pressure indefinitely without the necessity of the release and reapplication of the brakes, and without the aid of retaining valves.

CATALOGUES

AIR COMPRESSORS.—Bulletin 34-Y, issued by the Chicago Pneumatic Tool Company, is a catalogue of that company's gas and gasoline driven air compressors.

BOILER KOTE.—The Boiler-Kote Company, Chicago, in a 16-page booklet, details the advantage of using Boiler-Kote in boilers, and shows how it is used to secure the desired results.

WRENCHES AND OTHER TOOLS.—One of the latest catalogues issued by the Mechanical Specialties Company, Chicago, is a 16-page booklet illustrating and giving list prices on the company's line of wrenches, chisels, punches and similar tools.

EXPORT ENGINEERING AND CONTRACTING.—This is the title of a booklet issued by the American Steel Export Company, New York. The book explains about the export organization of the company itself, and gives a detailed list of the many kinds of equipment it is in a position to design and supply.

CAR HEATING.—The Gold Car Heating & Lighting Company, New York, has recently issued a catalogue descriptive of the Gold electric thermostatic control of steam heating for passenger train cars. The booklet explains the advantages of this system from the standpoint of uniform heating and economies in the use of steam, and explains how the system secures the desired results.

ELECTRIC HOISTS.—The Sprague Electric Works of the General Electric Company, 527-531 West Thirty-fourth street, New York, has issued bulletin No. 48,923, describing Type W electric hoists, one to six tons capacity. The various sizes and types of these hoists are clearly shown by photographs, detailed drawings and dimension tables. General specifications for the hoists are also given.

THE STROH PROCESS.—The Stroh Steel-Hardening Process Company, Pittsburgh, Pa., has recently issued a 24-page catalogue descriptive of the Stroh process. This is a method for casting fine alloy steel together with soft steel in one solid piece, this giving a casting with a wear-proof alloy steel stratum upon the wearing surfaces, while the body is composed of any desired steel, and is in no way affected. The catalogue contains a number of illustrations showing gears, wheels, frogs, crossings, etc., of Stroh steel.

TURRET LATHE.—The International Machine Tool Company, Indianapolis, Ind., has issued recently a 43-page catalogue describing the Libby turret lathe. The characteristics of this lathe are fully described and data is given regarding the various sizes of lathes made by this company. Numerous illustrations are included, showing the different parts of the lathe. Particular attention is given to the Collet chuck and its construction, each of the individual parts being identified. Various other tools used in connection with this lathe are also illustrated and described.

BALL BEARINGS.—"Hess-Bright Ball Bearings—How to Apply Them," is the title of a booklet recently issued by the Hess-Bright Manufacturing Company, Philadelphia, for the purpose of showing what precautions should be taken to preserve the "inherent efficiency and superiority" of Hess-Bright ball bearings. The booklet emphasizes the necessity of clean bearings and proper lubricants, the care that should be taken to prevent overloading, and the necessities of proper mounting. A number of drawings are given to bring out the points in the text. Another and similar booklet issued by the same company deals with the application of ball bearings to the airplane.

Railway Mechanical Engineer

Volume 91

October, 1917

No. 10

CONTENTS

EDITORIALS:		M. C. B. Letter Ballot Results.....	574
Location of Cab Appurtenances.....	529	Freight Car Apprentices on the Santa Fe.....	577
A Big Job Ahead.....	529	Unique Underframe Reinforcement.....	578
Locomotive Terminal Competition.....	530	Tank Cars for the Santa Fe.....	580
Second Call for Liberty Loan.....	530	Stresses on End Framing of Cars.....	582
The Railroad Y. M. C. A.....	530	SHOP PRACTICE:	
Utilizing the Boiler Capacity of Locomotives.....	530	Forging Machine Work at Silvis Shops.....	583
The Abuse of Compressed Air.....	531	Lathe Boring Tools.....	584
Freight Car Repair Situation.....	531	Folding Horse for Sheet Metal.....	584
Locomotive Repair Situation.....	533	Boiler Shop Apprenticeship Methods.....	585
High Points in Engine Maintenance.....	533	Die for Repairing Threads on Crosshead Pins.....	587
New Books.....	533	Radial Link Grinder.....	587
COMMUNICATIONS:		Gap Riveter for Steel Car Repairs.....	588
T. W. Too Sharp for M.M.....	534	Air Press for Rod Bushings and Driving Brasses.....	588
Unnecessary Transfer of Loads.....	534	Federal Inspection Requirements.....	589
GENERAL:		Some Oxy-Acetylene Repairs.....	591
Wake Up! Mechanical Department.....	535	Muffler for Use in Blowing Down Boilers.....	592
The Car and Locomotive Market.....	537	Proper Alinement of Locomotive Parts.....	592
Design of Heavy Helical Springs.....	539	Electric Arc Welding.....	593
Standardization and Improved Locomotive Service.....	541	NEW DEVICES:	
Railway Engineers Now in France.....	543	Simplex Clasp Brake.....	596
LOCOMOTIVES:		Type "B" Ragonnet Reverse Gear.....	597
Russian Decapod Locomotives.....	545	A Removable Driving Box Hub Liner.....	598
Modification of Federal Locomotive Inspection Rules.....	550	Acorn Die and Holder.....	599
Preliminary Locomotive Design.....	551	Cast Steel Pilot and Ash Pan.....	599
Firebox Temperature Experiments.....	556	Truck Lever Type Slack Adjuster for Freight Cars.....	600
Height of Firedoors.....	559	Mason Grease Cup Plug.....	601
Cross Balance of Locomotives.....	561	Arch Tube Cleaner.....	601
CAR DEPARTMENT:		Huntton Truck Bolster.....	601
Steel Car Shop of the E. J. & E.....	563	NEWS DEPARTMENT:	
The Economics of Car Design.....	565	Notes.....	602
Handling Material for the Car Department.....	567	Meetings and Conventions.....	603
Freight Car Maintenance.....	569	Personal Mention.....	603
		Supply Trade Notes.....	607

Location of Cab Appurtenances

Our American locomotives have been equipped with various labor saving devices to make the work of the engine crews easier and to increase the efficiency of the power, but little has been done, in a scientific way, to determine the proper location of the various cab appurtenances for the convenience of the men. We have known in a general way where the firedoor should be located on the back head of a locomotive boiler, but how high it should be above the cab deck was always a matter of individual opinion. In common practice, the door has been as low as 17 in. and as high as 25½ in., and until the motion picture studies made by the Pennsylvania it was anybody's guess as to which was correct. The tests made by this road, which are described elsewhere in this issue, show that a firedoor, the bottom of which is 22 in. above the cab deck, is the best average height regardless of the height of the firemen. At this height and with the coal always at the same point back from the door, a locomotive can be fired with the least muscular effort. This means more contented firemen and more efficient firing, as the fireman will not be wasting energy in the performance of his work. These tests also showed that with long fireboxes the coal can be better distributed with a grate slope of 2 in. to the foot. These and similar studies of the cab arrangement, which will result in a reduction of labor on the part of both the enginemen and firemen, will be reflected in the more efficient handling of the locomotive.

A Big Job Ahead

R. H. Aishton, president of the Chicago & Northwestern, gave some extremely interesting figures as to the growth of railway traffic in this country during the war in a paper before the St. Louis Railway Club last month. For instance, with only a small increase in the number of miles of line, locomotives and cars, the traffic for the calendar year 1917 promises to be 52 per cent greater than for that of the fiscal year ended June 30, 1915. This increase of 140,000,000,000 ton miles is equivalent to the total traffic moved annually before the war by the following 14 countries: Germany, France, Russia, Spain, Sweden, Switzerland, Roumania, Holland, Canada, South Africa, Mexico, Japan, Brazil and New South Wales. Stated in terms of tons, rather than ton miles, this increase would require 720,000 trains, containing 18,000,000 cars; this is equivalent to a train 136,363 miles in length.

The railroads are today unable to handle all of the traffic that is offered to them, and conditions will be worse as the winter comes on. The cars and locomotives are showing signs of the severe stress to which they have already been subjected. New equipment and additional facilities are not available. What can the mechanical department do? In the first place, cooperate more closely with the operating department. Utilize every possible pound of tractive effort, or at least get the operating department to do so. The charge has been made that the mechanical department, where it has had charge of rating the locomotives, has shown a tend-

ency to rate them too low. Train load figures on some roads would seem to substantiate this claim.

There is a tendency on the part of some mechanical department officers to pass the buck, or excuse themselves because they say they are working under impossible conditions and cannot do better under the present conditions of labor and material. The world today in every field of endeavor is doing things that only a year or two ago seemed impossible. The railways of this country must not and cannot fail, difficult and impossible as the conditions may seem. If every man in the mechanical department will really get busy and exert himself to the utmost, the problem can be solved. The difficulty is, of course, to push through a sufficiently patriotic educational campaign to do this—and yet it must be done.

Locomotive Terminal Competition

Remember that the competition on how to decrease the time a locomotive is held at a terminal which was announced in last month's issue, page 474, will close

October 22. There are only a few days left in which to write your story and get it to our New York office. We have named that peculiar date as we realize the necessity of publishing the articles received before winter begins. Tell us what you are doing to put the locomotives under your charge through the roundhouse with the least possible delay. In a large number of cases a locomotive spends more than one-half its time in the roundhouse or its immediate vicinity. This is too much under present conditions with the power in such great demand. We want to tell others how you have decreased your terminal delay. A prize of \$35 is offered for the best paper, \$25 for the second best, and \$15 for the third; all other contributions accepted for publication will be paid for at our regular space rates.

Second Call for the Liberty Loan

"Shall we be more tender with our dollars than with the lives of our sons?" is a slogan appearing on some of the posters calling for subscribers to the second Liberty Loan. It is particularly fitting in the case of railway men, many of whom have given their sons or comrades to the service of the Allies in France. The least we can do at home is to help our Government provide these men with the necessary facilities to complete the big task before them. Moreover, the Government will pay as much and more in interest than many savings banks. The first Liberty Loan was a great success, being oversubscribed by 50 per cent. We can show our enemies no better example of our unity and determination to win the war than by giving financial aid to our Government. A large number of railway men supported the first loan; in the Colonie (N. Y.) shops of the Delaware & Hudson, the main shops of that road, 73 per cent of the employees subscribed. Start a campaign on your own road and see if you can beat this record.

The Railroad Y. M. C. A.

This issue of the *Railway Mechanical Engineer* will reach its readers while the movement of the selected men to the National Army cantonments is still in progress. One of the organizations that will take a big part in the work of carrying these men will be the Railroad Y. M. C. A., which, by placing its secretaries on these trains will complete a Y. M. C. A. chain from "Home to Home." Despite its short notice the Railroad Y. M. C. A. succeeded in accompanying about 300 trains of the second contingent of 40 per cent. Its secretaries explained to the men the work that the Y. M. C. A. is preparing to do at the cantonments and told them how the Y. M. C. A. would accom-

pany them on their way to the cantonments, from the cantonments to their transports, at the piers, in London or in Paris where it has big hotels for the use of men on furlough, in camp in France, even in the front line trenches, and thence back once more to home. They also distributed post cards and stationery and in other ways, by personal contact especially, made the trip easier for the men themselves, for those in charge and for the train crews. But this is not all that the Railroad Y. M. C. A. is doing; it is meeting troop trains at division points; it is opening its buildings to the men in olive drab and it is meeting them at the embarkation piers to bid them "bon voyage." It also has men in France with the railway engineer regiments. In short, it is missing no opportunities to do its utmost for the soldiers.

Utilizing the Boiler Capacity of Locomotives

Many freight locomotives now operating on the railroads of this country have considerable potential tractive effort which is not being utilized. There are some cases where changes in the proportions of locomotives would make them much more efficient transportation units.

Before the superheater was generally adopted many locomotives were built with the boiler capacity too low for the cylinders, which resulted in steam failures and poor performance generally. The proportion of the heating surface to the cylinder volume was increased and much better performance was secured. At the present time it seems that this tendency has been carried too far in the case of many freight locomotives. Eight or ten years ago, it was by no means unusual to find locomotives designed with only 200 sq. ft of heating surface for each cubic foot of cylinder volume. At the present time this ratio is more often above 250 and sometimes greater than 300. In passenger locomotives this is no doubt good design, but there is little advantage in having a freight locomotive that can supply steam at long cut off at a speed above 20 miles an hour. It is the tractive effort at low speed and not the proportion of the boiler capacity to the size of the cylinders that determines what a freight locomotive can haul over the division.

There is of course a practical limit to the tractive effort which can be developed, determined by the adhesion between the wheel and the rail. If the full adhesion is utilized the locomotive will have a tendency to slip and will be hard to handle. Just where the practical limit is reached is hard to determine. The coefficient of friction between the wheel and the rail is usually considered to be about 25 per cent, which would call for a factor of adhesion of four. The value of the coefficient of friction generally used is probably lower than the actual value. Some roads have brought the ratio of adhesive weight to tractive effort down to 3.5 and 3.8 is by no means uncommon. It would seem that a locomotive with a factor of adhesion of four should not give trouble by slipping even after the drivers have been turned and the cylinders bored.

Where freight locomotives have ample boiler capacity to supply the cylinders and the factor of adhesion is greater than four the logical thing to do is to increase the size of the cylinders to make the tractive effort full 25 per cent of the weight on drivers, providing, of course, that the machinery is capable of standing the increased stresses which will result. It is hardly probable that the steam consumption will be unfavorably affected by the larger cylinders, and the hauling capacity will be increased.

When locomotives are modernized the factor of adhesion and the ratio of heating surface to cylinder volume should be carefully considered. Superheaters and brick arches are usually applied to save coal, the increased speed which it is possible to secure being considered an incidental advantage.

There seems no reason why the increased boiler capacity should not be utilized by making a corresponding increase in the tractive effort, due consideration being given, of course, to the strength of the machinery and the ratio of adhesion. On one road a superheater was applied to a large freight locomotive and it was found possible to increase the diameter of the cylinders $1\frac{1}{2}$ in. without overtaxing the boiler. It might be argued that the heating surface of a boiler does not always give a true indication of its evaporative capacity and it is difficult to forecast accurately the actual boiler performance, but in view of the fact that the cylinders can easily be bushed in case they are too large, it would certainly be best when changing cylinders, to make them large enough to develop the full adhesion of the driving wheels.

At this time, when the railroads are so hard pressed for motive power, any method of increasing the tonnage that can be hauled is of great importance. A careful consideration of the proportions of existing locomotives will in some cases, reveal sources of increased tractive effort that have not been considered.

The Abuse of Compressed Air

The introduction of tools driven by compressed air marked one of the greatest advances in railroad shop practice and such equipment is now almost indispensable. Compressed air is naturally adapted to use in railroad shops. The tools are made in such forms that they can be used in almost any location and they give little trouble if they receive a moderate amount of care and attention. Compressed air can be more readily applied to driving small tools than any other form of power. When a new device which must be independently driven is designed in a railroad shop the first thought is to fit it with an air cylinder to operate it. For tools that are used only a small portion of the time this is no doubt the most economical method of driving, but for those that are in operation continuously either belt or individual motor drive is usually to be preferred, as the decreased power consumption resulting from these methods of driving as a rule offsets the greater first cost as compared with pneumatic drive. Compressed air is in nearly every case the most expensive form in which power can be used, as few railroad plants are equipped with efficient types of compressors.

An interesting example of the extravagant use of compressed air in shop tools is furnished by a shear which was seen in operation recently at a large scrap dock. The whole device had been made from second-hand or scrap material, but while it testified to the ingenuity of the man who designed it, it could not be called an economical machine. The shear lever was operated by a 14-in. by 12-in. air cylinder which made a full stroke for each operation. The air was supplied from a line carrying a pressure of 100 lb. per sq. in. The machine was operated almost continuously and made an average of five strokes per minute. Thus it required 5.34 cu. ft. of compressed air, or 41.6 cu. ft. of free air, per minute, if full pressure was secured for only half of each stroke, a very conservative estimate of the air consumption. At a rate of two cents per 1,000 cu. ft. of free air the cost of power for this machine was 48 cents a day. The cost for such a machine if driven electrically should not have been more than one-fourth of that amount. The expense of installation of wiring would have been less than for piping and the reduced cost of operation would certainly have justified the greater initial expenditure for motor drive.

Air motors made in railroad shops are practically without exception extravagant in the use of air, usually due to the poor design of the apparatus. Pneumatic tools which give a fair output of power for the air consumed require a degree

of precision in their manufacture that cannot be attained with the machine tool equipment found in railroad shops.

A feature of compressed air installations that should be kept in mind is the possibility of large losses due to leakage. While, of course, in some pipe lines the losses are very slight, there are almost always small leaks in shop lines which are considered of no importance and are not stopped. The condition of connections is seldom given the attention it requires and much air is wasted at the fittings. With the high pressure carried, the loss due to even a small leak is quite considerable. At a pressure of 100 lb. per sq. in. a hole only $\frac{1}{16}$ in. in diameter will allow the escape of 387 cu. ft. of free air per hour. Assuming the cost of compressing air to be two cents per 1,000 cu. ft., a single hole of that size will waste power at the rate of \$5.50 per month. As a rule, there are numerous small leaks in every line of pipe, though often they are not apparent. At one shop where a leakage test of air piping was conducted it was found that the power lost in that way cost more than \$2,000 a year.

These observations should not be construed as reflecting unfavorably on compressed air as a power medium in shops. The intention is rather to show the waste that may occur in the system unless it is properly maintained and to emphasize the necessity for carefully considering all the elements entering into the cost of production to insure economy in shop operation.

Freight Car Repair Situation

How to get freight cars repaired is unquestionably one of the most serious problems confronting the mechanical department at the present time. With railroad operation speeded up as it is now, cars are certain to require more than the ordinary amount of repairs to keep them in good condition. There is plenty of evidence to show that the roads are getting more service from their cars than ever before. The achievement of the railroads in increasing the tonnage handled since this country entered the war has been remarkable. Cars must be kept in repair in order that this splendid record may be maintained.

During the past four months both the mileage and the tonnage per car have broken all previous records. During the period from 1913 to 1915, freight cars moved on an average from 26 to 28 miles a day. In 1916, this had increased to 31.5 miles and the figures for 1917 will be considerably higher as the latest available statistics show that the railroads in June handled 23 per cent more traffic than in 1916 with only 3 per cent more cars. At the same time the average carload and the average trainload have also increased.

There can be but one result; that cars require more repairs than under normal operation. New cars are not being received by the railroads in any considerable numbers, but the demand for equipment has been met by putting in service many cars that were formerly marked for retirement. Only a small proportion of these have been reinforced. The others will demand an abnormally large amount of repair work to keep them in service. Many roads have only sufficient facilities to take care of car repair work under normal conditions and to keep cars in serviceable condition during the war will necessitate a great increase in the output of the car shops.

The roads have made a good record in reducing the number of bad order cars during the past year. On June 1, 1916, 6.8 per cent of the freight cars of the country were in shop or waiting to be shopped, while on May 1, 1917, the percentage was 5.7. On June 1, however, the figure had risen again to 5.8. It should be noted that the decrease in the total number of bad order cars during the period from June 1, 1916, to June 1, 1917, was due to a reduction in the

number of home bad order cars, as the number of foreign bad orders increased 18 per cent during that period. This fact seems one of great significance. It shows that there is a tendency to neglect the repairs to foreign equipment. In some cases foreign cars are held for long periods awaiting repairs in spite of the heavy per diem charge. More often, however, just enough work is done on the foreign car to get it safely onto the line of some connecting road and after it has made a few hundred miles it is again ready for the repair track. The present rules permitting the loading of cars in any direction to handle the traffic keeps a great many cars off the home road for long periods and the condition of the cars suffers. As one chief interchange inspector remarked, "Everybody is ready to use the foreign cars, but nobody wants to repair them."

The shortage of cars, combined with the new car service rules, has created conditions which add to the importance and also to the difficulties of the car inspector's work. A broad construction of the M. C. B. rules is essential if they are to give the best result under the present circumstances. Cars must proceed with the least possible delay to avoid shortage of equipment and congestion of terminals. Of course, nothing should be done which would in any way jeopardize safety, but at this time inspectors are not justified in holding up cars for minor defects. To make out defect cards and collect the bills often costs more than the company receives for the repairs which it makes on the authority of the cards.

Car inspectors should not lose sight of the fact that the earning power of freight cars is greater now than ever before. Delays to cars cause delays to trains, with resulting expense due to the loss of time of train crews and locomotives. The amount that may be wasted through minor delays can be realized from the fact that a conservative estimate of the earning power of a freight locomotive at the present time is \$100 a day.

Cards should be issued for defects which demand repair, but the practice of carding for minor defects is a waste of time. It is not uncommon to find defect cards which have remained on cars so long that they have become illegible. The car may have run for months with the defect for which it was carded, there being no necessity for making repairs. This is often the case with such insignificant damage as raked siding, roofing raked on the end, metal posts slightly bent, etc. To issue cards for such defects is a foolish policy.

While cards should not be issued unless it is necessary, they should be applied when the conditions are such that the receiving line is entitled to protection. The practice of running cars on records should be done away with entirely. Some roads make a practice of tracing for defect cards on the assumption that cars have been run on records. It is doubtful whether the returns from this practice were ever sufficient to justify the expense. The sooner it is given up the better it will be for all concerned.

The changes made in the M. C. B. rules during the last year have been very few, and all inspectors should be thoroughly familiar with the present code. Some important changes have been made, however, in the loading rules and inspectors should study the revised rules and do everything in their power to see that shippers adhere to the proper methods of loading. Numerous delays result from improper methods of securing lading. If inspectors would make it a practice to report all cases of improper loading in order that the matter might be taken up with the shippers, conditions could be very much improved.

The new specifications for tank cars contain considerable material with which inspectors should be familiar in order to insure safety in the transporting of dangerous liquids. Of equal or greater importance are the regulations covering the handling of explosives. Large shipments of such material

will be made during the war, and the booklet of instructions issued by the Bureau of Explosives should be in the hands of every inspector.

The demand for cars is so great at this time that shippers will load cars almost regardless of their condition. If defects are discovered after cars are under load, the repairs are often more difficult to make or the load must be transferred. Inspectors can do a great deal of good if they will exercise their ingenuity to catch defects before cars are loaded.

Unfortunately, at the present time, it is not possible to route cars to points where it is certain that they will receive adequate repairs. Many eastern roads are now shipping westward freight which requires only rough freight cars. Unless some special effort is made to get these cars to shop points, they will not be in condition to handle grain and flour when they reach the western roads. Since these commodities often originate at points which are not provided with repair facilities, there is danger of cars being loaded which are not in condition to be used for such products. No dependence can be placed on car inspection by agents or elevator men, and if leakage is to be prevented, cars must be thoroughly inspected and repaired before they are sent out to be loaded. There is probably not an interchange point that does not have cases where cars are set back and transferred and sent back to some point on the delivering line without repairs being made. Soon the same car appears at another point under load and is either rejected with consequent loss, due to transferring the load, or it is moved on to make trouble on another line.

The condition of equipment is causing serious situations at some points where large numbers of cars are interchanged. Unfortunately, the large interchange points are not always shop points. Equipment cannot be handled readily if it arrives in bad order and long delays result. It has been suggested that shops operated jointly by several railroads would be a help in improving the conditions at large interchange centers. In some cases these facilities are badly needed by all the roads, yet the individual roads do not feel justified in going to the expense of putting up shops. The prices paid for repairs under the M. C. B. rules are not high enough at the present time to make such shops profitable.

Attention has already been called to the danger that lies in the practice of slighting the repairs to foreign cars and cars requiring complete overhauling in order to reduce the number of bad order cars. Nevertheless, there are many repair tracks that are following just such a policy. At one typical repair point, which was visited recently, a considerable number of foreign bad order cars were being repaired. While many required heavy repairs, only such work as was necessary to put them in a safe condition was being done. For example, one box car had been brought to the repair track because the draft timbers had been pulled out and one sill broken. About 25 per cent of the lining in the car was missing and the decking was broken. The repairs to the draft rigging were made, but the work required on the body of the car was not done. When it left the repair track, the car was fit for nothing but rough freight, and it was probably taken out of service again in a short time for body repairs. The foreman in charge of the work at this point volunteered the information that repairs to foreign cars were a losing proposition, since the price of materials had advanced so greatly. He had more work on system cars than he could take care of, and he couldn't bother much with foreign repairs.

The attitude of this car foreman is one too common found among the shop men. In their anxiety to save money for their company, they overlook the ultimate gain to be secured by furnishing serviceable cars to the road. Though

the prices of iron and steel products have been reduced, the increase in the cost of many other materials entering into the construction of cars has, of course, been much greater than the increase in the M. C. B. prices. There are several circumstances that should be considered in this connection, however.

In practically every case where material is applied to cars, scrap material is also removed. The price of scrap has advanced, so the increase in the net cost of the material applied is not so great as the increase in the price of new materials. Then, too, large stocks of materials were contracted for at prices lower than those prevailing at the present time, thus bringing down the average cost of the material. The present schedule of prices was adopted only after a careful consideration, and no man should slight the repairs to foreign cars because he fancies his road will be the loser. If every road gave the same attention to foreign cars that it gives to system cars, the debits and credits would be quite evenly balanced. Unless repairs are made as soon as defects appear and the work done in a thorough manner, cars cannot be kept in condition.

No one can deny that the car foremen have a hard task at this time. The shortage of materials is hampering the work on many roads, and the labor shortage is still more serious. The wages paid are lower than in the motive power department as a rule, and it is difficult to keep workmen. Much more time must be devoted to the supervision of inexperienced men who are being employed. The temptation to get the cars off the repair track regardless of whether they have been properly repaired or not is very strong. Such practices, if followed, will cause serious conditions this winter, when the traffic will probably be even heavier than it is now. What is needed is good, honest, thorough repairing that will put cars in condition to give service, repairing that will not only get the car off the repair track, but keep it off.

Locomotive Repair Situation

An officer in the mechanical department when asked what his road was doing to prepare its power for the oncoming winter replied—"We are giving it a 'lick and a promise,' the same as every one else"—and went on to explain that at the present time the demand for power was so great that it could not be spared long enough from service to be given the full repairs needed. We fear that this method of handling the power is too common throughout the country and we question greatly the judgment of those who follow this policy. It is true that the demands for power were never greater than they are today and it is likewise true that the demands later in the winter will be still greater.

It is a great temptation for a railroad to use all of its facilities to the limit when revenue freight is begging to be hauled. But it is a short sighted policy to do so when by so doing the facilities are deteriorating to such an extent that later, their capacity, when even more traffic will be offered, will be much decreased. At present it is not only good business to use these facilities with a thought of the future but it is the duty of every railroad officer to see that these facilities are not so crippled as to interfere with the demands next winter. The mechanical department officers are responsible for the power and equipment. It is their duty to see that their roads are properly protected. If too great a demand is made of the equipment under their charge they should not be afraid to refuse to supply it when they know that by so doing they are courting sure failure later on. It is better to place one embargo now than two later when it might mean disaster to the country. Make the equipment work to the limit. Do everything that is possible to increase its capacity to do more work. But don't kill it.

High Points in Engine Maintenance

"Power and still more power," is the crying need of American railways today. There are two items in locomotive maintenance that are fundamental in answering this appeal. They are good steaming qualities and efficient steam distribution. They are of prime importance and mean more tonnage hauled and the efficient use of fuel. The engine house forces should concentrate on these items. Keep the flues clean; see that the superheater is fulfilling its duty; stop the leaking tubes; maintain the front end in proper condition; be sure the brick arch is intact; keep the boiler clean and as free from scale as possible; do not neglect the washing of boilers; see that the grate and ash pan are such that sufficient air will be admitted to the firebox properly to consume the coal. There is nothing more discouraging to the engine crew than a poor steaming locomotive; it is as demoralizing as was the "fluke" in the Giants' pitching staff to the entire team in the second game of the World's Series. Don't try to offset any of these defects by decreasing the nozzle—this means high back pressure and loss of power. Seek out the real difficulty and correct it.

The importance of square valves is thoroughly realized by every intelligent railroad man. The danger is in procrastinating and "letting it go for this time." Our armies in the field never go into action without everything being thoroughly prepared. Carelessness and procrastination there mean loss of life and perhaps defeat. We likewise must go into action with our equipment adjusted to do its full work. Efficiency at home is as vital as efficiency at the front. We must move every possible pound of freight that we can.

NEW BOOKS

Air Brake Association Proceedings. Edited by F. M. Nellis, secretary. 270 pages, 6 1/4 in. by 8 1/2 in., illustrated, bound in cloth. Published by the association, 165 Broadway, New York.

This volume is the official report of the twenty-fourth annual convention of the Air Brake Association which was held at Memphis, Tenn., May 1 to 4, 1917. It contains papers on the Slack Action in Long Passenger Trains, Its Relation to Triple Valves of Different Types and Consequent Results in the Handling of Passenger Trains; Inspection of Brake and Signal Equipment; What is the Safe Life of an Air Brake Hose; Handling Heavy Tonnage Trains on Grades with Air Brakes Exclusively; the Functional Interrelation Between the Component Parts of the Air Brake System; Slack Action in Long Passenger Trains; Suggested Practice for the Cleaning and Lubricating of Brake Cylinder Packing Leathers, and revisions of the recommended practices. In addition to the papers, the discussion is given in detail. The Proceedings this year are prettily arranged typographically with the picture of the author of the paper and chairman of the committee accompanying each paper.

First Aid Instructions for Miners. By a committee of surgeons for the U. S. Bureau of Mines. 154 pages, illustrated, 5 1/4 in. by 4 1/2 in. Published by the Superintendent of Documents, Government Printing Office, Washington, D. C. Price, paper bound, 20 cents; stiff cover of red buckram, 25 cents.

This book, while prepared essentially for the instruction of miners, contains information that is of value to all who may be required to apply the first aid remedies to injured persons. It covers the subject quite thoroughly and includes an outline of an organization and the necessary equipment to be carried for the work, in addition to instructions regarding the handling of the patient. General information is given regarding the anatomy of the human body for the purpose of informing the first aid student so that he may better apply the principles outlined in the book. Instructions for action for all causes of accidents such as electric shocks, drowning, suffocation, cuts, etc., are included in the book, with plenty of illustrations to better describe the text. The pamphlet is perhaps the most complete treatise on this work that is included in the space given the subject.

COMMUNICATIONS

T. W. TOO SHARP FOR MM

(With Apologies to Wallace Irwin.)

CHICAGO, Ill.

HONORABLE EDITOR:

I have undergo peculiar experience recent which I assume to recite for benefit all crafty mms who plot downfall other U. S. Federal I. C. C. detectors.

At small shop in north of state, I are much worry alway by failure to find clear case on which to issue Form 5 invitation. Mm are one of hale fellows who create good cheer at Atlantic City where convention are congregate. Chief Detector have interrogate me frequent about what fine shop and fine equipment mm seem to attain and praise record of same railroad profuse. Last time I alight, I are all alert with suspicion assuming kultur and spy all sides. First thing happen are switch man who

always greet me with cordial relation step out to roundhouse running track and emit "whoop-pee, whoop-pee" to yard switchman $\frac{1}{4}$ mile away. This hand repeat exact antic and wave hat twice in circle around head also whoop-pee. I ponder now how this always repeat. I inquire to know this eulogy and switchman stutter and cough out that reason are weather report. I are curious to know what weather

are like and he say storm are approach. It require about 15 minutes to consume distance to shop by foot and when I arrive I meet mm and foreman on ashpit. I remember now this also are same proceeding. Honorable mm are exceeding pleasant telling joke and bestowing cigar on entire crowd.

I immediate see engine 1821 on pit with sharp driving wheel flange, deep wore tire, steam leaks and other defect. I volunteer that locomotive are in bad shape but mm laugh and say yes she going on drop-pit. I reply when and he report tonight when 1827 come off and point to shop card tack on pilot. I discover yard engine 1840 with brake pull-rod just escape rail, broken flange on inside pair tank wheel, tank leaking all points, lost sand pipe and two broken springs. I raise question this engine and mm reply she are mark for back shop. "Why do she have steam on?" I retort quick. He assume that this allow her to spot herself in shop so not to require shifter. I see 1836 on outbound track with valve stems blowing, bad leak at check valve and front cylinder cock gone. Foreman say he are holding engine now waiting for mechanic to repair. I see other engines but alway chalk mark are on pilot or man just starting to make repair. This are time I commence to smell mouse in woodpile and pass resolution in mind to call investigation. Things look like plot on U. S. government and I propose secret service. When I retire to station, mm smile broad, shake hand profuse and insist on two cigars with handsome gold wrapper. I arrive on train with nervous twitch in stomach and regret over being bunco. This are Friday night. Before sleep same night, broad smile same as mm also illumine visage poor Jap detector.

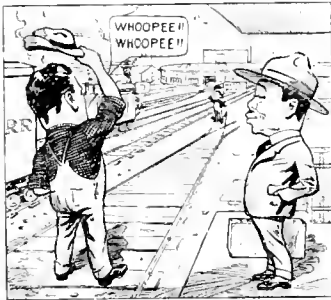

"First Thing Happen Are Switchman Who * * * Emit 'Whoop-pee, Whoop-pee' to Yard Switchman $\frac{1}{4}$ Mile Away."

Monday morning see me same town but unload on opposite side station, climb freight train and speed to shop without whoopee or periscope show. I visit drop-pit and see No. 1827 have remove but 1825 on not 1821. I go out in yard and find engine 1840 working successful with brake rod down, bust flange, seepy tank and broke spring just same like before. I issue Form 5 invitation to engineer who grin with benign love on me and order him to shop. When I reach pit, I are confront with No. 1821 just arrive with sharp flange, deep groove on tire and steam escape like Friday. I make out invitation on him also. Two more engines which I see Friday, I discover now same way only no shop card paste anywhere. By now mm and foreman emerge excited and with usual smile smother approach with brake off. Hon. MM remark what unexpect pleasure have arrive with me and I retort pleasure all to me when I deliver 4 invitation from U. S. government.

I remark quiet, "Understand your wireless system shorted herself in storm Friday night." He turn quick on about face and emit something about hyphenate and yellow peril which are not appreciate by me, but I assume it are new joke and laugh with quiet uproar. With extreme satisfy to inside conscience I remark solo voice, "whoop-pee," same as switch hand.

Yours truly,

TOBESURA WENO.

UNNECESSARY TRANSFER OF LOADS

DENVER, Colo.

TO THE EDITOR:

The loads of approximately 25,000 cars are transferred during each month throughout the United States to facilitate the repairing of defective cars. There is no doubt but that about half of these cars could be run safely to their destination with their defects and unloaded. As the matter now stands the receiving line is the judge as to whether or not the lading in the cars is to be unloaded, and inasmuch as the cost of transferring and the payment of the damage claim is made by the delivering line, it is of course natural for the receiving line to transfer the load whenever there is the slightest difficulty in making repairs, delays to the equipment being entirely overlooked.

We may figure that a car is held out of service about five or six days when its load is transferred, a great deal of the time being lost in switching the car to and from the repair track. This means that the railways lose the service of the car for six days. It would be a good plan, owing to the scarcity of equipment at the present time, for the railways to agree to haul the cars which are received in bad order and which could be handled safely to their destination, at the rear of the train. There is no question but that the car shortage would be reduced by about 12,000 cars a month if this practice were followed. This number of cars would take care of a great many shipments. Instances have been found where loaded cars have traveled 1,000 miles in bad order, which upon arrival at an interchange point, about 40 or 50 miles from their destination, were held by the receiving line, request being made for authority to transfer the load so the receiving line would not be obliged to make the repairs.

It would appear that while cars are so badly needed on all lines, that the railroads should get together on this proposition and agree to run such equipment as is reasonably safe to handle. It would not only help the receiving line, but also the delivering line. Furthermore, it would save the receiving line the labor of transferring a great many loads, and labor at the present time is about as scarce as the equipment.

WILLIAM HANSEN,

Chief Joint Inspector.



G. W. WILDIN



W. D. ROBB



D. F. CRAWFORD

WAKE UP! MECHANICAL DEPARTMENT

The Time Has Come When American Railroads
Must Recognize the Importance of This Department

THE Interstate Commerce Commission statistics for the year ending June 30, 1916, show that the maintenance of equipment expenses for all of the railroads of the United States amounted to \$570,326,407, or 25 per cent of the total operating expenses. When we remember that in addition to this direct expense for the maintenance of equipment the mechanical department requires the use of a large number of buildings and structures which are maintained by the engineering department; that a poorly designed or maintained locomotive can add greatly to the cost of maintenance of way; that one of the largest items of transportation expense is the fuel burned in the locomotives; and that the condition of the equipment and design of power affects the operating expenses in many different ways, the relative importance of the mechanical department is at once apparent.

In general, it is probably well within reasonable limits to estimate that one-half of the capital investment of an average road is in the cars and locomotives and in the equipment which is necessary to maintain them. A tremendous responsibility, therefore, rests upon the mechanical department and its head. American railroads for some reason or other do not seem to have an adequate appreciation of this fact, and as yet only one railroad on the continent—the Grand Trunk—has seen fit to dignify the office of the head of that department with an executive title.

Unfortunately, conditions as they have existed in the mechanical departments on many American railroads have not been such as to hold many officers who have been remarkably well fitted for the work. Other industries and even railway supply companies which manufacture only one or at most a few specialties which are required on a railroad, have been willing to pay salaries more commensurate with the ability of the men and have thus attracted a great number of them from the railroads.

Higher executive officers with little or no technical ability or knowledge have often interfered or dictated against the better judgment of the expert in charge of the mechanical

department. Bankers and financiers have made it necessary to break down organizations when business has temporarily fallen off, when they should have been hard at work getting the equipment in shape for busier times. When business did improve organizations were hurriedly gotten together and the work rushed through with a lamentable lack of efficiency. Many motive power officers have found their positions almost unbearable and impossible because of this and because of interference from above in the handling of labor. Then, too, there has often been a lack of co-operation between the various departments in the purchase of material or equipment, the advice of the mechanical department frequently being disregarded. These "cheapest in first cost," "lightest in weight" and "personal preference" purchase policies must absolutely be done away with and the recommendations of the mechanical department, based upon careful and critical analysis and technical study, must be recognized. Mechanical department officers may be criticised for lack of initiative in standardization of equipment, in the better organization of their forces, or for failure in developing the most efficient designs, and for many other things, but if the responsibility is put squarely up to them there is little doubt they will make good.

Conditions as to supervision in many mechanical departments are to-day in a most deplorable condition. In the first place, there is a minimum of supervision. In the next place, a large percentage of the minor officers are working longer hours and getting less salary than the day worker is receiving for his work. Many minor officers have gone back into the ranks as mechanics, thus being relieved of much responsibility without financial loss. Is it reasonable to expect that ambitious men will seek for promotion from the ranks under these circumstances? Where are the officers to be trained and developed for higher positions if this condition is allowed to continue?

On what basis should a mechanical superintendent or any other mechanical department officer approach his task?

How can such an officer be of the greatest possible value to his company? What possibilities are there for advancement if he makes good?

These are vital questions to any mechanical department officer. Indeed, his value to his railroad, to railroads in general, and to the prosperity of the country at large, depend entirely on how he answers them. Not a few mechanical department officers take a narrow view of their duty and responsibilities. They seem to measure or gage their success in terms which fail to comprehend in a big way the problem on which they are engaged—terms which have no vital relation to the efficient operation of the road as a whole. They forget that the real business of a railroad is transportation, and do not realize that their chief object should be to serve and be useful to the operating department. They forget also that they should act as business men and operate the mechanical department on strictly business principles with a view to successful operation.

In some cases there may be a shadow of an excuse because of the narrow conception of the real function of the railroad on the part of their superiors. The bankers who control the properties are, in the last analysis, often to blame. Conditions are changing rapidly, however, and it is up to the mechanical department officer to grasp the full significance of his opportunity and get his house in order. That greater recognition is being given to mechanical department officers is indicated by recent promotions and appointments.

As was noted in the September number of the *Railway Mechanical Engineer*, page 475, W. D. Robb, of the Grand Trunk, has the honor of being the first vice-president in charge of motive power, cars and machinery on the American continent. Why was Mr. Robb thus honored? What qualifications does he possess which specially fit him for his new position? The organization on the Grand Trunk has been somewhat different from that of other roads in the United States and Canada. Mr. Robb, as superintendent of motive power, did not have authority over the car department, but in its place had full responsibility for the engineers and firemen. It is significant that he has had splendid success in handling the labor problem. He is positive, a capable organizer, thorough and careful in his methods, and has kept his power in first-class condition. He will not stand for "paint shop repairs," and his subordinates understand this clearly and fully. Equipment builders have had reason to feel it also, because of Mr. Robb's insistence upon standards of design and workmanship.

That Mr. Robb is equipped with that degree of vision and foresight which is so essential for a successful executive officer is indicated by the persistent way in which he has developed modern apprenticeship methods. Except for a few glaring exceptions, other roads have failed to give this subject the attention it deserves, although the railway press, and men like Basford, Purcell, Cross, Thomas and Russell have persistently, forcefully and intelligently pounded it home. Mr. Robb has undoubtedly felt that he has been many times repaid for his efforts in this direction in the returns which he has received in the past three years alone. A real vision, an active imagination and the backing of the management have been factors in his success in this work.

If Mr. Robb's administration of motive power affairs has been weak in any respect, it is because of the lack of contributions from the Grand Trunk to improved features of locomotive design; on the other hand, Mr. Robb has not been slow in taking advantage of those things which have been developed on other roads, and have been found to be successful. He has steered clear of fads.

Another appointment which was announced in the September number of the *Railway Mechanical Engineer* which holds a certain amount of promise to the mechanical department was the promotion of George W. Wildin from

general mechanical superintendent to general manager of the New York, New Haven & Hartford. Mr. Wildin, of course, leaves the mechanical department, and in this respect his promotion has a very different significance from that of Mr. Robb. It is reasonable to suppose, however, that it will result in a greater appreciation of the mechanical department on the part of the management, for few men have had so varied experiences in that department as Mr. Wildin, or have more reason for appreciating the necessity of giving the department a fair chance and a square deal.

Mr. Wildin is a big, broad gage, forceful, outspoken chap. He is orderly and systematic and a good handler of labor. He is a resourceful and ingenious designer, and knows the mechanical department from start to finish, for he has held about every different kind of job that that department can offer, and his experience has not been confined to any one section of the country.

The promotion of D. F. Crawford early in the year from general superintendent of motive power to general manager of the Pennsylvania Lines West, will also be remembered. It serves to emphasize the possibilities for promotion for mechanical department officers, and recalls also the deeply grounded understanding on the Pennsylvania that the chief function of the mechanical department is to serve the operating department to the best of its ability.

Mechanical department men have viewed with delight the steady climb upward of W. W. Atterbury to the vice-presidency of the Pennsylvania, presidency of the American Railway Association and to his recent appointment as brigadier-general in charge of railway affairs in France under General Pershing. Mr. Atterbury started in as an apprentice in the Pennsylvania shops at Altoona, and in 1903 was promoted from general superintendent motive power to general manager, becoming a vice-president in 1909.

H. C. Oviatt, who was appointed general superintendent of the New Haven at New Haven last spring, began as a locomotive fireman on that road, and rose to the position of assistant mechanical superintendent before being transferred to the operating department. He has just left the New Haven to take an important position in charge of transportation for the American International Corporation, division of ship building, at Philadelphia.

John Purcell, in charge of mechanical department affairs on the Santa Fe, has the title of assistant to the vice-president, which is well deserved, and we hope will some day be shortened by three words. H. H. Vaughan had this same title before he left the Canadian Pacific to engage in the munitions business. J. Hainen, in charge of the mechanical department on the Southern Railway, is also designated as assistant to the vice-president.

Among present executive and operating officers who came up through the mechanical department are E. D. Bronner, vice-president and general manager of the Michigan Central; G. H. Emerson, general manager of the Great Northern, and M. K. Barnum, assistant to the vice-president, B. & O.

Before leaving railroad service F. A. Delano, now on the Federal Reserve Board, rose to the presidency of the Wabash, and later of the Chicago, Indianapolis & Louisville. W. H. Marshall was general manager of the Lake Shore & Michigan Southern, and John E. Muhlfield was vice-president and general manager of the Kansas City Southern.

We must not forget Frank W. Morse, who preceded Mr. Robb as superintendent motive power of the Grand Trunk and was vice-president of that system, and later of the Chicago & Alton, and the Toledo, St. Louis & Western; nor Jacob N. Barr, who was superintendent of motive power of the Chicago, Milwaukee & St. Paul, Baltimore & Ohio, the Erie, and later became assistant to the president of the Chicago, Milwaukee & St. Paul; nor G. L. Potter, who came up through the mechanical department and finally became a vice-president on the Baltimore & Ohio.

THE CAR AND LOCOMOTIVE MARKET

Railway Supply Field Concentrates on Orders for the Government. More Cars Will Likely Be Ordered

THE car builders have completed the first car on the government orders for about 12,000 cars for the American forces overseas. The car shown in the illustration is a standard gage high side gondola and is one of the original order of 6,000 standard gage cars reported in last month's issue. The car has a capacity of 33 tons as compared with the usual four-wheel French car of not over 20 tons capacity. It is 30 ft. in length, its cubical content is 1,386 cu. ft., and its weight is 32,800 lb. The car body is built largely to French standards with side buffers and screw couplings, the last being necessary as it will operate with French rolling stock. It is, however, carried on American arch bar trucks, with standard M. C. B. journal boxes, and is fitted with standard American air brake equipment. The rod over the top of the car is to support a tarpaulin to protect the car contents, this rod being adjustable

railroads or the governments of foreign countries. The total orders for locomotives during the months of August and September were only 26 although it is a fact that the New York Central and the Norfolk & Western did reserve space in locomotive shops for something like 270 locomotives. The total orders so far this year, including these reservations, now amount to 3,770 as compared with 3,067 at this time last year. The 1917 figure includes the government orders for 680 standard gage and 384 narrow gage locomotives, 2,406 locomotives for domestic use as compared with 2,043 at this time last year and 1,310 locomotives for export as compared with 1,024 last year.

Exclusive of the government contracts mentioned above for 12,997 freight cars, there were ordered during August and September only 8,073 cars for domestic use and 197 cars for export. The total orders for domestic use at the

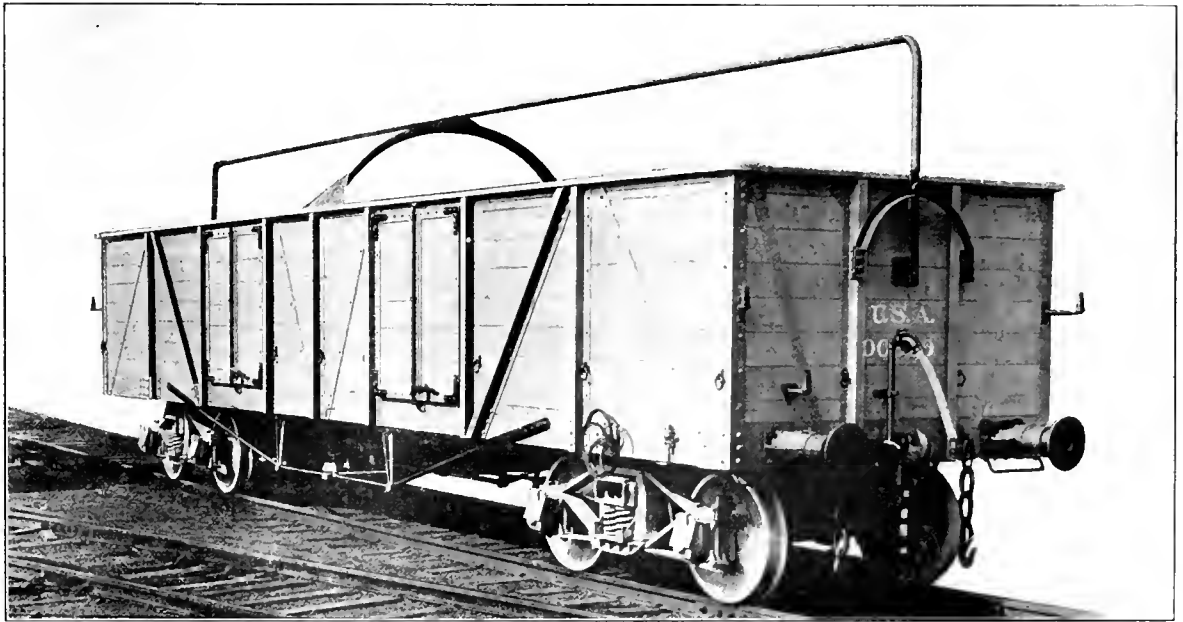

Copyright, 1917, Committee on Public Information.

United States Government Car Built for Service in France

so that it may be swung down along the side when necessary.

The United States Government since August 18 has placed orders for 680 standard gage Consolidation locomotives, 195 narrow-gage Prairie type steam locomotives and 189 narrow-gage gasoline locomotives, all for service in France. It has also on order 9,000 standard gage freight cars on two different sets of orders and 3,997 narrow-gage freight cars. The Committee on Public Information is authority for the statement that "additional orders for both narrow and standard gage equipment are likely." This shows to what a great extent the United States Government is depending upon the railway supply field to help in the war.

A glance at the figures of recent car and locomotive purchases will show, however, that outside of these government contracts but few orders for cars and locomotives have been placed during the past two months by either the American

end of September totaled 51,228 as compared with 67,364 at this time last year and 50,159 this time in 1915. The export orders this year now total 26,047 as compared with 20,675 this time last year and 30,275 in 1915.

It has been suggested that the American railroads might be called upon to send locomotives or freight cars overseas to France; in other words, to make the same sacrifices along this line that have been made by England. It is now beginning to be evident that this will probably not be done, partly because the American railroads are in no position to suffer the loss of this equipment, and also because there is considerable question as to whether the American equipment could be used with the clearance of the railway lines in France. The railway supply field is being called upon to do what the railways might otherwise be called upon to do and the American railways should consider themselves fortunate that the supply field is in a position to carry out

this work. The American railways, however, will suffer seriously because they will be unable to get the locomotives that some of them have now had on order for some time. The government contracts will of course be given priority over all the business and it is likely that the contracts for foreign governments will come next. This may mean, for example, that a road which ordered locomotives four or five months ago for delivery next February may be able to get them, not in February, but if it is fortunate, seven months later, in October.

This brings us to the matter of prices. The recent reduction in prices of steel will therefore apparently have no definite effect upon the American railroads' opportunity to secure new equipment any sooner. The reductions in price may result in more orders for locomotives being placed but these orders will merely be added to those that are now on the locomotive building companies' books to be built in their turn.

There is good reason to believe further that the Russian Government, the French Government and possibly the British Government may also be coming into the market from time to time for engines in addition to those they already have on order and there are persistent reports in the trade that the placing of Russian contracts for large numbers of engines can be expected at almost any time.

Daniel Willard, president of the Baltimore & Ohio and chairman of the Advisory Committee on National Defense, brought this out in a paper that was abstracted in the September issue of the *Railway Mechanical Engineer*. It is worth while reproducing here again the conclusions that he brought out in that paper. "Shall we," he said, "in order to make our own task somewhat easier, to meet a situation that is undoubtedly pressing here, hold on to all the new engines we can build, facing the possibility that because of such action we may have to send 2,000,000 more of our young men to the battle line? Or shall we say to the builders, 'You send the engines that Russia wants, you send the engines that France and England want, and we by additional effort will undertake to carry the greatly increased burden put upon us, with what we already have'; that is why I ask you to be more careful of your power, to keep it in better shape, to get more out of it, to try constantly to do more with what you have. Not because we do not want to spend money, although that is a good reason, but because we want to send every available car and engine to our Allies so that on that account we will be called on to send fewer of our young men. I want you to think of that seriously."

REDUCTIONS IN PRICE OF STEEL

The car building plants in this country would have, under favorable conditions of a supply of labor and material, a capacity of 300,000 cars a year. It has been noted above that the total orders for cars this year including domestic, foreign and United States Government orders, have added up only to 90,272, only one-third of the total of the capacity. The buying of freight cars has been seriously handicapped by the high prices for equipment and it is to be supposed that the reductions in the price of steel may have some effect on the placing of orders by the railways for 1918 delivery. It is true that there may also be further orders by our own and foreign governments but in view of the fact that some of the plants have only been operating to 30 and 50 per cent of the capacity it can be seen that the chances for getting new cars is much better than the chances for getting new locomotives. The reductions in the prices for steel were announced on Monday, September 24. The reductions were the result of a more or less voluntary agreement of the steel producers with the War Industries Board and were based on the cost of production figures as ascertained by the Federal Trade Commission. The prices, which will apply alike to purchases by the government, the Allies and the pub-

lic which includes the railroads as large users of steel, become effective immediately subject to revision on January 1, 1918, and are as follows:

Commodity and Basis	Price agreed upon	Per cent of reduction
Iron ore, lower lake ports	\$25.05
Coke, Connellsville	† 6.00	43.1
pig iron	‡ 33.00
Steel bars, Pittsburgh, Chicago	‡ 2.90	47.3
Shapes, Pittsburgh, Chicago	‡ 3.00	50.00
Plates, Pittsburgh, Chicago	‡ 3.25	70.5

* Gross tons. † Net ton. ‡ Hundredweight.

It is understood that these prices will not affect existing contracts, but that they will probably be of more immediate benefit to the railroads than the coal prices recently fixed, which applied only to the 20 to 25 per cent of the supply uncontracted for and which in many cases were higher than the prices agreed upon in long term contracts of large consumers.

The agreement stipulated that there should be no reduction in wages and the steel men pledged themselves to exert every effort to keep production up to the maximum.

One of the big problems encountered was similar to that so often discussed in consideration of railroad rates, involving the question of how to fix prices that would enable the small mills to produce without loss while preventing the larger plants from making too great a profit. It was settled by a plan which there has been great reluctance to apply to the railroad situation, of attempting to allow a fair price to the smaller producers, even if it does allow the larger producers a greater profit, but this decision was facilitated from the government standpoint by the fact that a large part of the profits may be taken by taxation.

Measures will be taken by the War Industries Board for placing orders and supervising the output of the steel mills in such a manner as to facilitate and expedite the requirements for war purposes and to supply the needs of the public in the best interests of all.

Coincident with the announcement of steel prices, the priorities committee of the War Industries Board made public its first general priority circular, giving instructions as to priority in orders and work for all individuals, firms, associations and corporations engaged in the production of iron and steel, and in the manufacture of their products. The committee is composed of Judge Robert S. Lovett, chairman, Major General J. B. Ayleshire, George Armsby, Rear Admiral M. E. Mason, Edwin B. Parker, J. Leonard Replogle and Rear Admiral A. V. Zane.

Under the regulations all orders and work are divided into three classes. Class A comprises war work, i. e., orders and work urgently necessary in carrying on the war. Class B comprises orders and work which, while not primarily designed for the prosecution of the war, yet are of public interest and essential to the national welfare, or otherwise of exceptional importance. Class C embraces all other orders and work. All orders will be classed as Class C unless covered by certificates to be issued by the committee. Orders and work in the other classes will have precedence and classes A and B will in turn be separated into subdivisions composed of orders regarded respectively as of greater moment and to be given precedence in accordance with serial number. Certificates will be issued upon application specifying the classification of the order or work. Certificates of a subsidiary nature will be issued upon request for the furnishing of material and articles required in manufacturing the article or prosecuting the work ordered. War orders of the Allies, as well as of the United States, will be placed in Class A in the case of those already contracted for. Orders previously placed by the War and Navy departments or the Shipping Board will be classed as subdivision A-1 of Class A unless otherwise ordered. Orders already placed by the Allies for war materials will be classed as subdivision A-2 of Class A unless otherwise ordered.

DESIGN OF HEAVY HELICAL SPRINGS

A Study of Spring Deflection with Computations for Single and Nest Springs, and Illustrative Examples

BY G. S. CHILES AND R. G. KELLEY

II

[The first part of this article was published in the September *Railway Mechanical Engineer* on page 477, of which the last five paragraphs are repeated here on account of an error in the text.—Editor.]

In designing an inner coil to work with the coil of Example 3, that is to conform to the same free and solid heights, and the same fibre stress, it will be necessary to maintain the

same ratio of $\frac{D}{d}$ which, for the outer coil, is 3.40.

The outside diameter of the inner coil, allowing $\frac{1}{8}$ in. clearance, will be 27.8 in.

Selecting at random a value of d for the inner coil of, say, $3\frac{1}{4}$ in., we obtain the following results:

$$D = D_o - d = 2.875 - .75 = 2.125 \text{ in.}$$

$$\text{and } \frac{D}{d} = \frac{2.125}{.75} = 2.83$$

Let us see what would result if a value of 2.83 for $\frac{D}{d}$ was used for the inner coil, and 3.40 for the outer coil.

Assuming the solid and free heights of $9\frac{3}{4}$ in. and 12 in. were adhered to for the inner coil, the fibre stress when solid would be 115,300 lb. per sq. in. instead of 80,000 lb. per sq. in. as for the outer coil. The free height of this coil

could be decreased in proportion to the increase in $\left(\frac{D}{d}\right)^2$, or to give a deflection of

$$\frac{2.83^2 \times 2.25}{3.40^2} = 1.57 \text{ in.}$$

making the free height

$$9.75 + 1.57 = 11.32 \text{ in.}$$

The fibre stress could also be decreased by increasing $\frac{D}{d}$.

Since the outside diameter of this inner coil is limited, due to the inside diameter of the outer coil, the value of $\frac{D}{d}$ can only be increased by decreasing the value of d .

With a $\frac{11}{16}$ -in. bar the value of $\frac{D}{d}$ is 3.18 and 3.60 for a $\frac{5}{8}$ -in. bar.

Using the same free and solid heights for the inner coil as for the outer coil the $\frac{11}{16}$ -in. and $\frac{5}{8}$ -in. bars would have a fibre stress when solid of 91,400 and 71,600 lb., respectively. In case the 91,400 stress in the $\frac{11}{16}$ -in. bar was considered too high, the free height could be reduced, $\frac{1}{8}$ -in. reduction or a free height of $11\frac{7}{8}$ in. would give a maximum fibre stress of 80,300 lb., while $\frac{1}{4}$ in. reduction or a free height of $11\frac{3}{4}$ in. would give 81,200 lb.

As a simple illustration let us assume a value for d of $7\frac{1}{8}$ in. Then it will be found that:

$$\frac{D}{d} = \frac{4.125 - .875}{.875} = 3.715$$

which is still too large. Selecting a $1\frac{1}{2}$ -in. bar, we will obtain a value of $\frac{D}{d}$ equal to 3.41, a value which is sufficiently close for all practical purposes to that of the outer coil.

The following is an example showing how the free height may be determined when D_o , d , h , S and G are known:

Example 4:

Outside diameter = 8 in.
Diameter of bar = $1\frac{1}{8}$ in.
Solid height = $5\frac{3}{4}$ in.
Fibre stress when closed = 87,300 lb. per sq. in.

Substituting in equation (12),

$$H = \left[1 + \frac{3.1416 \times 87,300}{12,600,000} \left(\frac{6.4375}{1.5625} \right)^2 \right] 5.75.$$

$$H = [1 + 0.0218 (4.12)^2] 5.75,$$

$$H = [1 + 0.0218 \times 16.974] 5.75,$$

$$H = [1 + 0.370] 5.75 = 1.37 \times 5.75 = 7.878 \text{ in.}$$

The dimensions used in this example are those of the outer coil of the M. C. B. Class G spring, with the exception that $7\frac{7}{8}$ in. is the free height given.

To find the weight when the solid height is given. Since the cross sectional area of a round bar is equal to $\frac{\pi d^2}{4}$ it is evident that the cubical contents of the blunt length of the bar is equal to:

$$\frac{L \pi d^2}{4} \dots \dots \dots (16)$$

But from equation (2)

$$L = \pi \left(\frac{D}{d} \right)^2 h$$

Therefore the cubical contents of the bar must be

$$\frac{\pi^2}{4} d D h \dots \dots \dots (17)$$

and assuming the weight of steel to be 486.6 lb. per cubic foot:

$$w = 0.695 d D h \text{ (lb.)} \dots \dots \dots (18)$$

Various other formulae are in common use, but they all give practically the same results, the principal difference being due to the fact that different values are used for the modulus of torsional elasticity, and the number of effective coils.

In checking a "nest" of springs in order to determine the height for a given load it is necessary to determine the load which will compress each individual coil a fixed amount, preferably solid. One method, in which the calculated and test curves for a four coil spring are given, is illustrated in Fig. 9. The tabulated data in the upper right hand corner comprises all the information respecting the various coils. Each individual coil is calculated separately, the values being found in the order shown in the table. The theoretical curves are drawn in dotted lines, being merely straight lines joining the free height point with the point corresponding to the load required to compress the coils of the spring solid. The points to which the complete spring curve is plotted represent the sum of the values obtained by adding the values of the similar points of the four separate coils.

Each coil of a "nest" of springs built to the above specifications was tested and plotted as indicated, then the four coils were assembled and the complete spring tested. These theoretical or calculated and actual or test curves approximate each fairly close, the outer and second coils being slightly low near the top, while the outer coil goes solid at $7\frac{3}{4}$ in., or $\frac{1}{4}$ in. higher than called for in the specification. This

action on the part of this one coil of course caused the complete spring to become solid at $7\frac{3}{4}$ in., and decreases the capacity of the complete spring some 2,000 lbs., inasmuch as it goes solid at 29,000 lb. instead of about 31,000 lb.

In Fig. 10 are shown the theoretical and actual test results for another four coil spring. The size of the bar for the various coils is the same as in Fig. 9, as is also the outer diameter, but the solid height has been increased $1\frac{1}{2}$ in.; i. e., from $7\frac{1}{2}$ in. to 9 in., and the free height of the three outer coils has been changed from $11\frac{1}{8}$ in. to $13\frac{1}{2}$ in., the inner coil only going to 13 in. A corresponding increase in y and n will be noticed. The values for $\frac{D}{d}$ and R are the same in Figs. 9 and 10, but the values for L , S and P are slightly different. The fibre stress of the three inner coils is slightly greater in Fig. 10, and the load correspondingly so, but the inner coil, due to a free height of only 13 in., has a smaller value for S and P than that of Fig. 9. While the total deflection of the inner coil in Fig. 10 is greater than that for the same coil in Fig. 9, (4 in. as against $3\frac{5}{8}$ in.) the deflection per coil is as 4 divided by 20.57, and 3.625 divided by 17.14, or 0.194 in. per coil for Fig. 10, and 0.211 in. per coil for Fig. 9. Since $\frac{D}{d}$ is the same for each coil, the fibre stresses are to each other as the deflection per coil.

height. The load carried by the coil in question, and consequently that by the complete spring, can be altered by either of these methods.

The load on any coil can be varied in much the same manner, that is, either by increasing or decreasing the fibre stress; the load increasing directly as the fibre stress is increased and vice versa.

The following data may be instructive in that it brings out very forcibly the fact that, in the case of a spring composed of two or more coils having approximately the same value of $\frac{D}{d}$ and the same solid and free heights, the loads carried by each coil bear the same proportion to the total load as the weight of each coil does to the total weight of the complete spring:

Number of Coil	Outer	Second	Third	Complete Inner Spring
Outside diameter (in.)	9 $\frac{1}{2}$	6 $\frac{3}{8}$	3 $\frac{7}{8}$	2 $\frac{1}{8}$
Diameter of bar (in.)	1 $\frac{5}{8}$	1 $\frac{1}{2}$	1 $\frac{1}{4}$	1 $\frac{1}{8}$
Weight of coil (lb.)	80	34	13	5
Weight carried by coil at a height of 10 in. (lb.)	16,600	7,150	2,500	1,000
Per cent of total weight of spring	60.6	25.8	9.8	3.8
Per cent of total load carried at 10 in.	60.9	26.2	9.2	3.7
Note.—Solid height 9 in. and free height 13 in. for all coils. Values for $\frac{D}{d}$ are the same as shown for coils in Figs. 9 and 10.				

The above data was compiled by first calculating and then weighing and testing a spring built up of four separate coils, and it is plainly evident that the figures verify

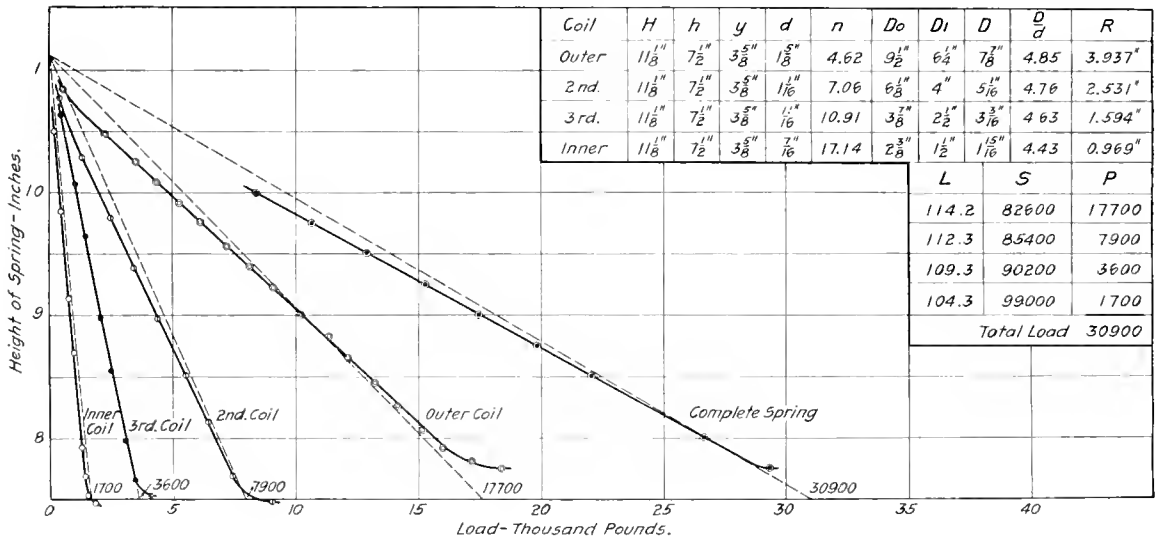

Fig. 9—Calculated and Test Curves for a Four Coiled Spring

In Fig. 9 the actual heights fell below the calculated heights for the two outer coils, and also for the complete spring while in Fig. 10 the actual heights are above the calculated heights for the two outer coils, and for the complete spring, but are below those for the two inner springs. Differences such as these can usually be, partially accounted for at least, if the various dimensions are checked carefully, and the actual values used in the calculation rather than the specified values as was the case in both Figs. 9 and 10.

It will be noticed that, as the ratio of $\frac{D}{d}$ becomes less, the fibre stress when the coils are solid increases; this is true only when H and h are equal. In case the fibre stress of one coil is too low, it is only necessary to increase the free height of that coil; if it is desired to decrease the fibre stress of one or more coils, it can be effected by decreasing the free

the statements just made. Thus, in line 4 of the above table we note that the weight of the outer coil is 80 lb. and the weight of the entire spring is 132 lb. Thus the percentage of the weight of the outer coil to the weight of the spring complete is 60.6 per cent, which is the value shown in line 6 of the column referring to the outer coil. Similarly, in line 5, we find that the weight carried by the outer coil when the spring has been compressed to a height of 10 in. is 16,600 lb., which is 60.9 per cent of 27,250 lb., the total weight carried by the entire spring when it stands at a height of 10 in. These values of 60.6 per cent and 60.9 per cent check each other very closely. Knowing the total load carried by the entire spring, the weight of each coil and the weight of the spring complete, this constitutes a simple method of determining approximately the load which will be carried by each coil.

In compression, as in tension springs, the load is exerted

axially, and any section of the bar is subjected to torsion. The twisting moment PR must equal the moment of the shearing stresses, or from equation (5) we get:

$$P R = \frac{\pi d^3}{16} S \dots\dots\dots(19)$$

$$\text{and } S = \frac{P R}{\frac{\pi d^3}{16}} = \frac{16 P R}{\pi d^3} \dots\dots\dots(20)$$

The formulae for torsional strength and stiffness given above are based on the polar moment of inertia, and polar modulus, but it should be kept in mind that they hold true only as long as the unit stress does not exceed the elastic limit of the material.

The assumptions used in developing the theory of torsion are not strictly applicable to any but circular sections. St. Venant found in his investigations on the strength of square and rectangular sections that the greatest stress and strain occurred at the middle of the (longest) side of the section.

STANDARDIZATION AND IMPROVED LOCOMOTIVE SERVICE

BY GEORGE ARMSTRONG

Standardization as reflected in past efforts of railroad equipment builders and designers has been aimed toward the securing of a more universal application of a few particular types of equipment. There are, however, other possible phases of standardization, applicable to existing equipment, and which, in the strenuous pressure of war times, deserve serious consideration. Material is difficult to obtain, manufacturing facilities are over-crowded, and transportation demands are such that every available source of power is required for the highest percentage of effective service.

Not only do the exigencies of war time operation demand that every effort be expended to keep transportation equipment in service, but this must be done with as small a drain as possible upon the other necessary industries. All un-

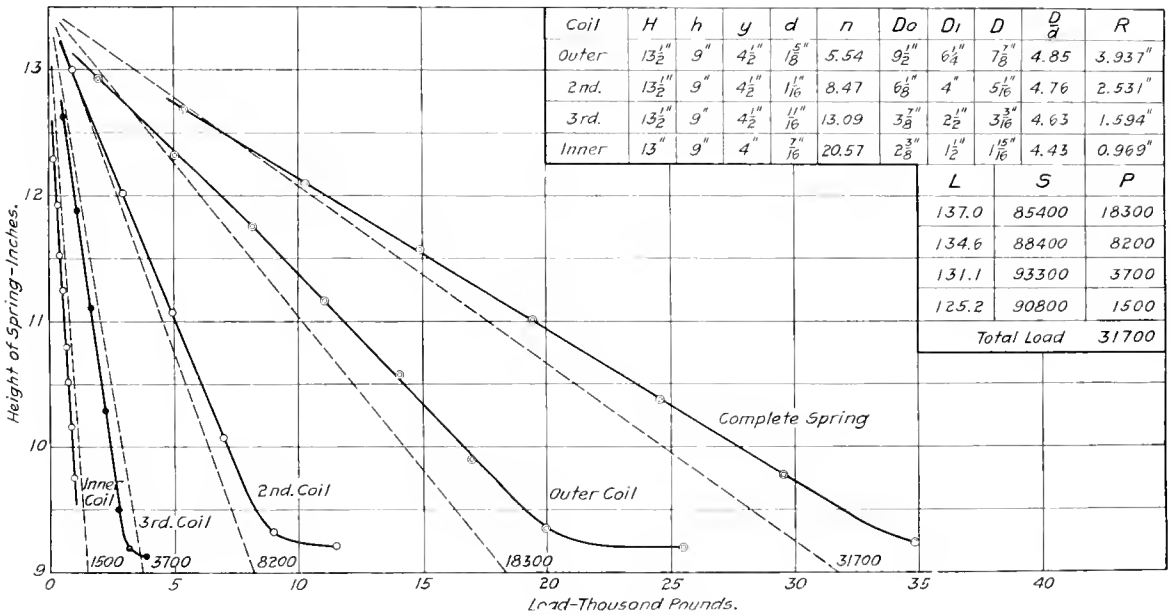

Fig. 10—Similar Curves to Those Shown in Fig. 9 for a Longer Spring

Using the values as found in his experiments for square sectioned steel, the following is obtained:

$$S = \frac{P R}{.208 d^3} \dots\dots\dots(21)$$

$$P = \frac{.208 d^3 S}{R} \text{ or } \frac{.416 d^3 S}{D} \dots\dots\dots(22)$$

$$y = \frac{7.16 P R^2 L}{G d^4} \text{ or } \frac{1.79 P D^2 L}{G d^4} \dots\dots\dots(23)$$

$$y = \frac{45.00 P R^2 n}{G d^4} \text{ or } \frac{5.62 P D^2 n}{G d^4} \dots\dots\dots(24)$$

The weight of bar, $w = 0.88 d D h$ (lbs.) where, d equals side or square.

Comparing the formulae for square section and circular section springs of equal areas (weight for weight) we find a closely coiled circular section coil spring of given diameter is almost 1.4 times as strong and will absorb 1.6 times as much energy as one of square section of the same diameter D .

LIFE OF CAST IRON PIPE.—The Illinois Central reports that some 6-in. cast iron pipe which had been in service for 40 years was found in such good condition on the relocation of its shops at Centralia that it was used again.

necessary waste of labor or material, loss of time because of equipment unnecessarily standing idle, and every needless operation performed either in the transportation or manufacturing industries, is more than a waste affecting the individual or corporation—it is an economic waste affecting the nation. Never before have we had so forcefully impressed upon us the fact that our obligations are broader than the individual; in a new and larger way we are being brought to realize our obligations to the state and to society.

Effective service from equipment implies a minimum delay for repairs. This delay is the time necessary to perform the required repairs, the time for preparation of the needed material and the unnecessary time lost in waiting for material not available. Each contributing factor is susceptible of improvement

Methods for more efficient employment of labor have been expounded in the past and are, or at least should be, well known.

Delays due to material may be reduced by:

First: Group assignment of power to reduce the required stock of material.

Second: Standardization so that a stock of partially or

wholly completed parts centrally produced, may be maintained.

Third: Standardization of other parts not susceptible to centralized finishing, thereby reducing the required supply of raw work and the possibility of shortage.

ASSIGNMENT OF POWER.

Much needless duplication of stock is often necessitated by an assignment of power so that several engines of a small number comprising a class, or similar classes, are distributed over many divisions rather than group assigned to one division, or at least to a few divisions and those adjacent, if possible. Often there is no reasonable excuse why this equipment cannot be more compactly assigned, while a careful consideration and group assignment will often permit a substantial decrease in the idle investment in raw materials scattered over the railroad at numerous points for protection against failures. Each piece of material unnecessarily stored at some point, each piece unnecessarily used, is an additional drain on the industrial resources of the country, and prevents the production of some article which may be badly needed.

Needless demand for materials, however small, in the aggregate may be a powerful factor tending to increase the railroads' "cost of living," already disproportionately high. Every useless operation performed in the repairs to equipment adds to the increasing shortage of labor. The highest patriotic duty demands the utmost conservation of natural and industrial resources consistent with unimpaired efficiency of the transportation service.

One railroad having 35 Mikado type locomotives equipped with 8½-in. cross-compound pumps has this equipment scattered over various divisions, requiring the maintenance of repair parts for these pumps at eight points. One division alone has 56 Mikado engines assigned to it, and consequently it alone could easily utilize these 35 locomotives, thereby reducing the stock of parts required, as only the two terminals at the end of the division and the point shopping these engines would require repair parts.

Another example is the assignment of one class X-1 passenger locomotive on a division where part of another class of practically similar tractive effort and general dimensions is in use so that a locomotive of this latter class could have been transferred from another division and the class X-1 engine used on one of the four other divisions to which the remaining engines are assigned.

Six switching engines, class B-25, are distributed so that five are at one terminal and one at another terminal 500 miles removed. Ten class B-62 switching engines are distributed, nine at the same terminal as the B-25 noted above and one at a terminal 700 miles away. A distribution of class M-10, M-11, M-12 and M-13 Consolidation freight locomotives is promiscuously made over several divisions upon any one of which these particular classes will give equal service, as the engines are of practically the same proportion and tractive effort.

STANDARDIZATION OF PARTS.

Standardization of parts, as far as possible, has still greater possibilities for resulting in improved effective equipment than assignment of power. The multiplicity of parts required where no attempt is made at standardization often results in unnecessarily long delays in returning equipment to service when repairs are required. The benefits to be derived from standardization are:

First: Reduction of the investment in idle stock.

Second: Decrease in the possibility of waste through eventual scrapping of obsolete material.

Third: Greater possibility for checking consumption of material and eliminating waste due to improper maintenance factors.

Fourth: A substantial reduction in the cost of manufacturing standardized parts through centralized production*.

One railroad has three styles of 12-in. piston valves, one style of 13-in., two of 14-in. and one of 16-in. used on a total of 12 different classes of equipment. A slight modification of the various valves and bushings would allow the use of one 12-in. and one 14-in. valve to cover the requirements. The 12-in. valve could be adapted to the engines requiring 13-in. valves by increasing the thickness of the steam chest bushing. The 14-in. piston valve could be adapted to the cylinder requiring the 16-in. valve through similar means. These modifications would allow the machining of the bull rings, followers, valve body and packing rings at a central shop and they could be distributed to the various points requiring them. This cannot be done to advantage where seven valves are required, several of which are used on only a total of 20 or 25 engines. These modifications would not only effect a reduction in the cost of making these parts, but would often assist in a ready turn of power owing to the possibility of maintaining a stock of completely machined castings.

Under the existing conditions, these engines require 21 castings for the various valve parts, four for the piston valve packing rings and seven for the steam chest bushings, a total of 32. If modified, as outlined, only six different castings would be required for the valve parts, two for the packing rings, two for the bushings and two for the adaptor bushings mentioned for the 13-in. and 16-in. valves, a total of 12 castings.

Another item, a prolific cause of holding power where no attempt is made at standardization, is grate material. One eastern railroad has solved this problem by reducing its number of grate castings from 25 or 30 to 5 which fill the requirements from Santa Fe and Mallet type locomotives to the small locomotives with narrow fireboxes set inside of the frames. In addition to reducing the number of grate castings required, attention was also paid to the center and side bearing bars, resulting in a substantial reduction in the number of different castings required for this purpose.

Another eastern railroad has solved the oil cup and grease cup cover question by adopting one casting for all classes of power and for both oil or grease cups. When the cover is to be used on an oil cup, it has a small hole drilled through the center, otherwise it is only turned and threaded when used on a grease cup. This cover is adapted to the various sizes of oil cups by means of a renewable steel bushing manufactured in quantities on a turret lathe and which is either screwed into the rod or dropped into place and pinned or secured by electric spot welding. As the threads in this bushing can be maintained standard, the possibility of losing loose oil cup covers is materially lessened.

Another expedient adopted by a number of railroads, which is resulting in a considerable reduction in material and labor, is the short pilot made from scrap, either old flues or steel car parts. Many railroads still maintain the long nosed pilot projecting beyond the face of the coupler. Much needless destruction results, due to contact between two pilots of engines head-end on at an ash pit or at other points around terminals. In addition to overcoming this loss, the short pilot is considerably cheaper to manufacture.

Crosshead and knuckle pins afford another large possibility for standardization and consequent economy in the use of material. Often slight variations in the diameter or length, or even in the thread of the nut are made which cannot be justified. These pins are admirably adapted for quantity production on a high duty turret lathe from old axles without any work being required to draw them down. These steel axles are otherwise serviceable only as scrap, as

* See *Railway Mechanical Engineer*, June, 1917, page 289.

the large amount of scrap steel axles accumulated on the average railroad in the course of a year cannot all be utilized in making small forgings. The production of these in large quantities, roughed down in two sizes to within either a quarter or one-half inch of the finished size ready to be fitted, as is one railroad's practice, will often assist materially the outlying terminal in quickly returning power to service instead of its being necessary to forge a pin under the hammer, or waiting until one is obtained from the nearest shop.

Front, back and intermediate crank pins can also be made in this manner, being finished complete with the exception of the wheel fit. Driving boxes, shoes and wedges, cylinders, smoke stacks, exhaust nozzles, injectors, air pumps and

air brake fittings, truck side frames, crossheads, valve gear parts and numerous other parts present possibilities for standardization and substantial economy in maintenance costs and reduction in terminal delays.

The subject of group assignment of power, standardization of parts and centralized production has always afforded substantial reward for serious consideration, but their possibilities are particularly advantageous under present conditions. While standardization applied to existing power might seem expensive when viewed in the aggregate, its value, particularly when accomplished at the time locomotives are overhauled, will warrant the most serious consideration.



RAILWAY ENGINEERS NOW IN FRANCE

Press Despatches Tell of Interesting Experiences of the American Corps in London and at the Front

BY day and by night the men of the American regiment of engineers which has taken over a nimportant line of French strategic railways are hauling tons upon tons of ammunition and other supplies to the French army units operating against the Germans.

"The American regiment," continues an Associated Press despatch, "has been turned over as a unit to the French and is getting all its supplies except clothing from the French government. The officers and men entered upon the work with the greatest enthusiasm, and they have been under German bomb and machine-gun fire from airplanes.

"Within the last few nights a heavy train of supplies hur-

ranks and the engineers who so far have not been bombed are openly jealous of their more 'fortunate' comrades. So far none of the regiment has been under shell fire, but the men may yet have a taste of the noisy German 5.9s and the whistling 'Percys,' 'Wooly Bears' and 'Whiz-bangs.'

"There is a great spirit of comradeship among the officers and men, most of whom have worked together and have known each other for years. The regiment is known as an operating unit as opposed to the engineers enlisted as construction units.

"Before proceeding to the front the regiment was quartered in a little French town within the zone of the French army. The arrival of the Americans at this town was kept secret and they marched into the place late at night after all lights had been extinguished. The soldiers were not allowed to smoke, strike matches or say a word. Despite the stealthy entrance, however, the French townspeople knew quickly of the arrival and soon the streets were filled with a quiet throng which joined in among the Americans and paraded with them arm in arm.

"It was one of the strangest welcomes any troops probably ever received anywhere, but it was at the same time one of the most sincere."

THE PARADE IN LONDON

Before landing in France, the railway engineers were in England. They were in training for a time and paraded through London. A London newspaper clipping received from one of the American engineers indicates what a holiday the English made of this parade:

"Very early in the morning people discovered their viewpoints and waited patiently watching the enormous crowds that joined us. Traffic was diverted or stopped altogether. Shops were shut and business suspended and later the meeting of the War Cabinet itself was adjourned so that the prime minister and his colleagues might become as the people of the streets making greeting to the men who 'mean to see it through.' . . . Londoners are not very ready to cheer. Theirs is the way of silent tribute. But yesterday they forgot the silly traditions of British reserve. They might have been Irish or Italian in their wild enthusiasm. For, as the first Americans were seen, cheers were raised such as have never been heard in London. . . . Louder and still louder rose the cries as the Stars and Stripes came in view. Soldiers in the crowd saluted; men raised their hats, and women threw their flowers and waved their handker-



Copyright by Underwood & Underwood, N. Y.

The Stars and Stripes at the Head of the Engineer Corps—London

ing toward the front was attacked by several enemy planes. None of the bombs came dangerously close, but every time the fire-box of the engine was opened for stoking the planes swooped down upon the train and spattered it with steel-jacketed bullets.

"This fire got so hot that eventually the train was stopped, the crew taking refuge beneath the engine. Relating their experience afterward these trainmen rather 'swanked' about it over their inexperienced brothers.

"The spirit of adventure is strong throughout the American

chiefs—and some of them sobbed happy tears of pride such as no man or woman need remember with shame."

NEW ENGINEER REGIMENTS TO BE RAISED

Almost coincident with the news that the railway engineer regiments are now at work in France comes the news that there will be organized additional engineer regiments and that the present nine railway regiments will each be increased in size.

In General Order No. 108, just made public by the war department, the President directs that there be organized for the period of the existing emergency, the enlisted strength being raised and maintained by voluntary enlistment or draft, special and technical engineer troops, including six regiments, and additional smaller units of engineers for each army and 14 regiments for the line of communications, the organization of the latter being under the direction of S. M. Felton, director general of railways.

The authorization for the line of communications, which includes the nine railway regiments already organized, but also provides for an increase in the number of men in each company, from 180 to 250, is as follows:

1. A general construction service, consisting of the following: 1 regimental headquarters, 6 engineer companies (construction), 6 service battalions (4 companies each).
2. An engineer supply service, consisting of the following: 1 regimental headquarters, 2 battalions of engineers (supply) of 3 companies each, 2 battalions of engineers (workshop) of 3 companies each, 3 service battalions (4 companies each).
3. A forestry service, consisting of the following: 1 regimental headquarters, 10 battalions of engineers (forestry) of 3 companies each, 9 service battalions (4 companies each).
4. A quarry service, consisting of the following: 1 regi-



Copyright by Underwood & Underwood, N. Y.

American Soldiers Passing over Westminster Bridge, London

mental headquarters, 2 battalions of engineers (quarry) of 3 companies each, 3 service battalions (4 companies each).

5. A light-railway service, consisting of the following: Construction department, 1 regimental headquarters, 5 battalions of engineers (railway) of 3 companies each, 3 service battalions (4 companies each); operation and mechanical department, 1 regimental headquarters, 4 battalions of engineers (railway) of 3 companies each, 3 service battalions (4 companies each).

6. A standard-gage railway service, consisting of the following: Construction departments, 5 regiments of engineers (railway) (the 11th, 15th, 16th, 17th and 18th engineers, railway, National Army), 8 service battalions (4 com-

panies each); operation and maintenance department, 2 regimental headquarters, 6 battalions of engineers (railway) of 3 companies each, 3 service battalions (4 companies each); mechanical and supplies department, 1 regiment of engineers (shop) (19th engineers, railway, National Army), 1 battalion of engineers (railway) of 3 companies, 1 service battalion (4 companies).

Of these the regiments for the general construction service, the engineer supply service, the forestry service, and the light railway service are new. The 9 regiments already organized are the 11th to the 19th, inclusive. The 20th engineers (forestry) is being formed at American University, Washington, D. C. The 21st engineers, for construction of light railways, is being organized at Camp Grant, Rockford, Ill., under Col. Edward Peak, with H. J. Slifer, consulting en-

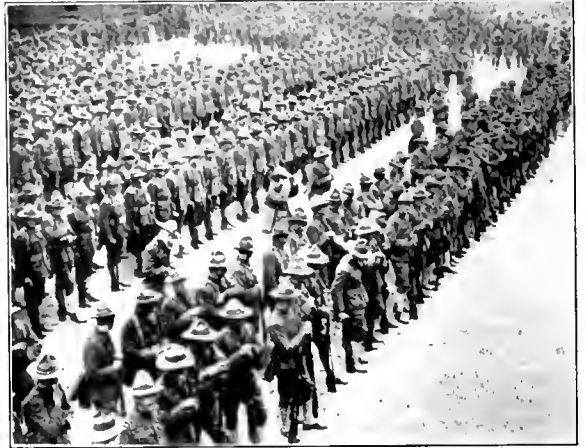

Copyright by Underwood & Underwood, N. Y.

A Rest After the Enthusiastic Parade

gineer and formerly general manager of the Chicago Great Western, as lieutenant colonel.

Service battalions will be transferred from one service to another as may be necessary. Engineer troops of a special service may be utilized in another engineer service in the discretion of the commanding general concerned.

Railway operating and shop troops, forestry troops, and service battalions will be equipped as infantry, but only 10 per cent will be armed, except during training, when all will be armed; non-commissioned officers of these organizations will be armed with pistols. All other special engineer troops will be armed as divisional engineer troops.

The National Army cantonnments will be utilized for the organization of the units herein authorized. The cantonnement at which each unit is to be organized will be determined by the chief of engineers after consultation with the quartermaster general. When necessary for special engineer training, these organizations may be sent to one of the regular engineer training camps.

The selection of officers for these regiments is under the direction of Mr. Felton, Capt. E. N. Sanctuary of his staff being in charge of matters of personnel. Railway men who have been drawn under the terms of the selective service act may be transferred to the engineer regiments.

RUSSIAN RAILWAY LOAN.—The Petrograd newspapers announce the forthcoming issue of a second so-called railway loan. The money will be used for 17 railway companies which have been taken over by a syndicate of banks. The loan will be for rubles 750,000,000 (\$386,000,000), the rate of interest 4½ per cent, and the price of issue \$1 1/3.



LOCOMOTIVES

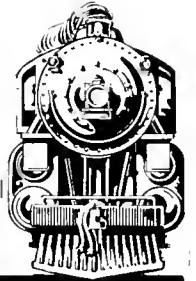

RUSSIAN DECAPOD LOCOMOTIVES

Built in America for Russian Government; Important Russian and American Practices in the Design

ONE of Russia's most imperative needs, at the present time, is increased transportation facilities. Additional motive power and rolling stock are urgently required, and American manufacturers are furnishing locomotives and cars in large numbers, as rapidly as facilities will permit. Since the summer of 1914 the total number of heavy freight locomotives ordered by the Russian Government railways from the Baldwin Locomotive Works and the American Locomotive Company is 1231, the former company furnishing 725 and the latter 506. These engines probably constitute the most notable group of heavy power ever shipped by American locomotive builders to a foreign country. Those last ordered will be completed during the year 1918. In ad-

dition, 50 locomotives of similar type have been supplied by the Canadian Locomotive Company.

main line and 350 ft. on sidings, and to handle 1,300 metric tons up a grade of 0.8 per cent, at a speed of 8 to 10 m. p. h. They have ample capacity for doing this, while working at a fairly economical cut-off.

The locomotives now being built by the Baldwin Locomotive Works and the American Locomotive company are identical in construction. In general design they follow American practice, although many of the details are in accordance with Russian standards. The Russian engine crews can, therefore, handle them without difficulty.

The boiler is of the straight top type, with a wide firebox which is placed above the rear pair of driving wheels. The boiler center is placed 10 ft. above the rail, and this allows

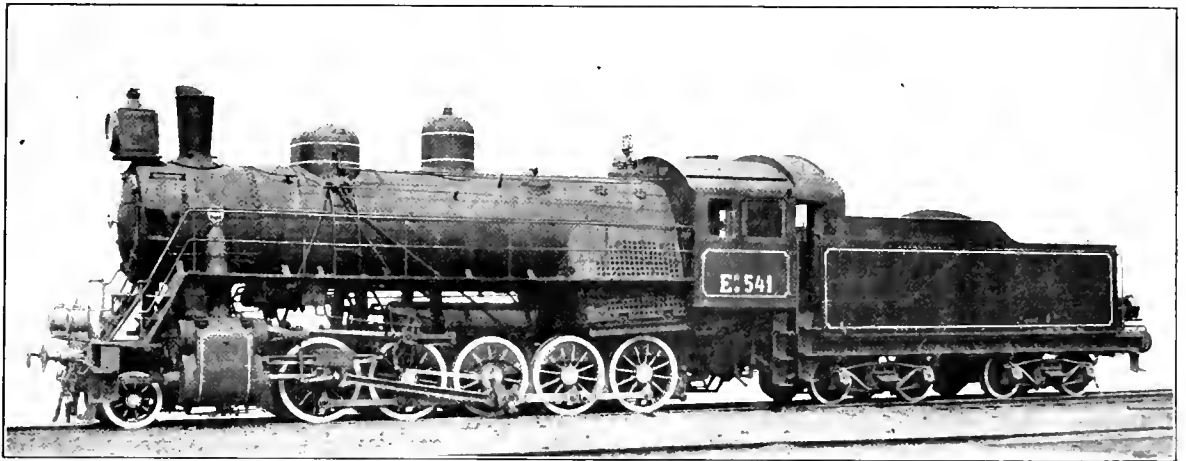

Russian Government Decapod Locomotive

The design and construction of these locomotives were under the direction of A. I. Lipetz, chief of the locomotive division of the Russian Mission on Ways of Communication in this country. They have been built on a number of different orders; but, although the later engines present various changes in details, as compared with those first constructed, the locomotives are all of the same general design and hauling capacity. The wheel arrangement is 2-10-0, and the tractive force exerted is 51,500 lb. The maximum load per driving axle is limited to 16½ metric tons. The locomotives are designed to operate on curves of 700 ft. radius on the

ample room for a deep throat, and for the installation of a Security sectional arch supported on water-tubes. The firebox is radially stayed, and a total of 462 flexible stays are used in the water legs. Of these, 286 are placed in the sides; 84 in the backhead and 92 in the throat. In addition, four transverse rows of expansion stays support the front end of the crown and one row is used at the back.

The equipment of hand-holes and wash-out plugs is unusually complete; and a man-hole, 15½-in. in diameter, is placed on the round of the boiler on the left hand side, just forward of the firebox. The dome is of the built-up type, with an inside diameter of 30 in. Three safety valves are provided, one of these being mounted on the dome cap, and

the other two on a specially designed turret, placed over the firebox and immediately in front of the cab. Two whistles are also mounted on this turret, and the rigging is so arranged that one of them can be blown from the train, by means of an outside cord connection.

The throttle valve is of the sliding type, in accordance with

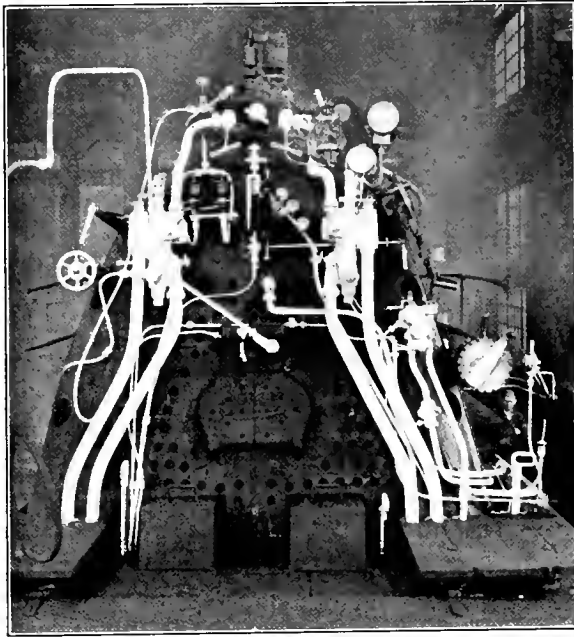

A View of the Back Boiler Head with the Cab Removed

Russian practice with a small auxiliary valve which opens first, facilitating the opening of the large valve and this same small valve is used when drifting on engines which have no by-pass valves. It has outside connections with the lever in the cab and is arranged to open with a downward movement of the slide. There are two ports in the vertical throttle-pipe, and they are tapered in width, so that a very small opening

This construction replaces the single damper opening in the bottom of the box, which is ordinarily used in American locomotives. The cylinders are of the two-piece type, designed in accordance with American practice. The steam distribution is controlled by 12-in. piston valves. These are fitted, at each end, with light cast steel heads and spiders, between which is placed a cast-iron bull ring. The heads and spiders are mounted on the valve stem, which is extended through the front head. The packing rings and steam chest bushings are of gun-iron. The Walschaert valve gear is applied,

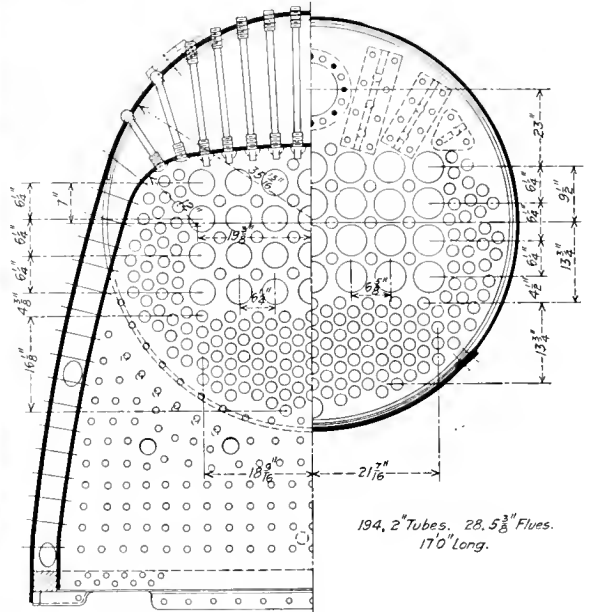

Half Sections Through the Firebox and Smoke Box

in combination with a screw reverse mechanism of Russian type. The pistons are of rolled steel, with extended piston rods, and the crossheads are light steel castings sliding on single bar guides. The back end of the main rod is fitted

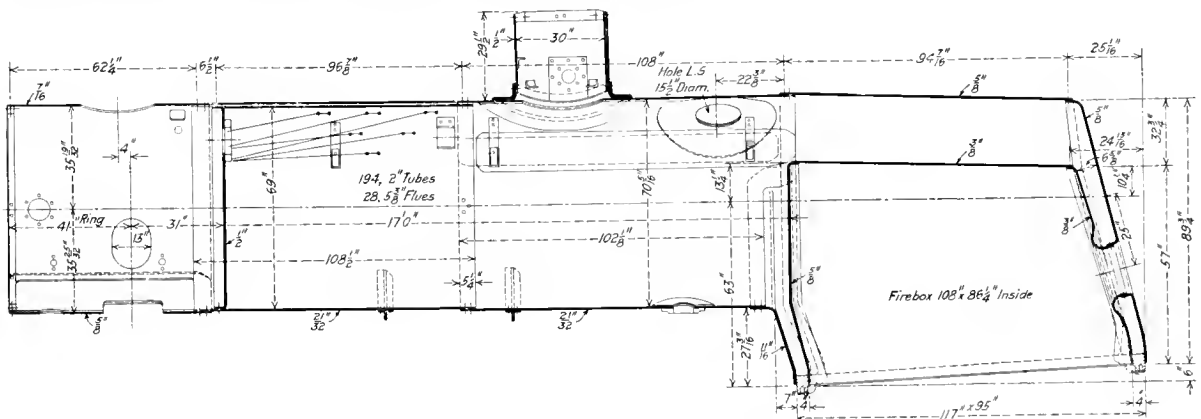

Boiler of the Russian Decapod Type

can be obtained. Springs are provided to assist in holding the slide against its seat.

These locomotives use superheated steam, and are equipped with a 28-element fire-tube type superheater. The superheater damper is arranged with several openings, which are placed in the front wall of the box enclosing the header.

with a forked stub of Russian design. A steel filling piece is slipped over the fork between the brass and the key and this filling piece is fitted with a lug through which pass the two key adjusting bolts.

Some of these locomotives are equipped with the Zyabloff by-pass valve. This device is arranged with a pipe connec-

in 34 packages. All the parts are boxed, with the exception of the boiler, driving-wheels, engine truck and tender wheels, and tender truck frames. The heaviest package, apart from the boiler, which weighs 56,450 lb., is the box containing the tender tank and various tender details. This box weighs 29,700 lb., and measures 25 ft. 4 in. by 10 ft. 4 in. by 8 ft. 3 in. The frame box, which contains one pair of frames complete, is also notable because of its size, as its measures 38 ft. 7 in. by 3 ft. 6 in. by 1 ft. 3 in., and weighs 17,200 lb.

Further particulars of these locomotives are given in the table of dimensions:

<i>General Data</i>	
Gage	5 ft.
Service	Freight
Fuel	Soft Coal
Weight in working order	201,000 lb.
Weight on drivers	176,500 lb.
Weight on leading truck	24,500 lb.
Weight of engine and tender in working order	(about) 333,400 lb.
Wheel base, driving	18 ft. 8 in.
Wheel base, total	27 ft. 10 in.
Wheelbase, engine and tender	60 ft. 3½ in.

<i>Cylinders</i>	
Kind	Simple
Diameter and stroke	25 in. by 28 in.

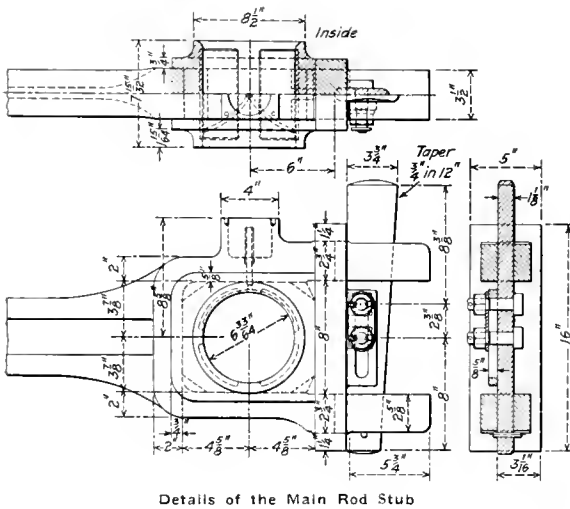

Details of the Main Rod Sub

<i>Valves</i>	
Kind	Piston
Diameter	12 in.

<i>Wheels</i>	
Driving, diameter over tires	52 in.
Driving, diameter of center	1 in. 170 mm.
Driving journals, main, diameter and length	10½ in. by 12 in.
Driving journals, others, diameter and length	8½ in. by 12 in.
Engine truck wheels, diameter	33 in.
Engine truck, journals	6 in. by 12 in.

<i>Boiler</i>	
Style	Straight
Staying	Radial
Working pressure	180 lb. per sq. in.
Inside diameter of first ring	69 in.
Thickness of sheets	21/32 in.
Firebox, length and width	108 in. by 86¼ in.
Depth, front	76¼ in.
Depth, back	67¼ in.
Firebox plates, thickness, sides, back and crown	¾ in.
Firebox plates, thickness, tube	¾ in.
Firebox, water space	4 in.
Tubes, number and outside diameter	194—2 in.
Flues, number and outside diameter	28—5½ in.
Tubes, length	17 ft.
Heating surface, tubes	2,383 sq. ft.
Heating surface, arch tubes	27 sq. ft.
Heating surface, firebox	200 sq. ft.
Heating surface, total	2,610 sq. ft.
Superheater heating surface (steam side)	579 sq. ft.
Grate area	64.6 sq. ft.

<i>Tender</i>	
Wheels, diameter	36 in.
Journals, diameter and length	5½ in. by 10 in.
Water capacity	7,400 gal. (U. S.)
Coal capacity	8 metric tons

MODIFICATION OF FEDERAL LOCOMOTIVE INSPECTION RULES

As a result of a conference between representatives of the carriers, of the railway employees and of the chief inspector of the Locomotive Inspection Bureau of the Interstate Commerce Commission, an order was issued on September 20 by the I. C. C. giving modifications, for the period of the war, in certain of the rules and instructions for the inspection and testing of steam locomotives and tenders, to be effective at once and to continue in force during the period of the war, as follows:

"Rule 2—The lowest factor of safety for locomotive boilers which were in service or under construction prior to January 1, 1912, shall be 3.25.

"Effective six months after the close of the war the lowest factor of safety shall be 3.5.

"The dates on which factors of safety from 3.5 to 4, as provided in rule 2, become effective, shall be advanced for a period equivalent to the duration of the war.

"Rule 10: *Flues to be removed.*—All flues of boilers in service, except as otherwise provided, shall be removed at least once every four years, and a thorough examination shall be made of the entire interior of the boiler. After flues are taken out the inside of the boiler must have the scale removed and be thoroughly cleaned. This period for the removal of flues may be extended upon application if an investigation shows that conditions warrant it.

"Rule 16.—The date for removal of lagging for the purpose of inspecting the exterior of locomotive boilers as provided by rule 16, except where indication of leaks exist, shall be advanced for a period equivalent to the duration of the war.

"Rule 23.—*Method of testing flexible staybolts with caps.*—All flexible staybolts having caps over the outer ends shall have the caps removed at least once every two years and also whenever the United States inspector or the railroad company's inspector considers the removal desirable in order to thoroughly inspect the staybolts.

"The firebox sheets should be examined carefully at least once a month to detect any bulging or indications of broken staybolts. Each time a hydrostatic test is applied the hammer test required by rules 21 and 22 shall be made while the boiler is under hydrostatic pressure not less than the allowed working pressure, and proper notation of such test made on form No. 3.

"Rule 110.—*Time of cleaning.*—Distributing or control valves, reducing valves, triple valves, straight-air double-check valves, and dirt collectors shall be cleaned as often as conditions require to maintain them in a safe and suitable condition for service, but not less frequently than once each six months.

"Add to Rule 112.—On E. T. or similar equipment where the brake cylinder pressure is maintained regardless of piston travel the maximum piston travel for driving wheels brakes shall be 8 in.

"Rule 128 (d).—*Locomotives in road service.*—The total amount of side motion of rods on crank pins shall not exceed ¼ in.

"*Locomotives in yard service.*—The total amount of side motion of rods on crank pins shall not exceed 5/16 in.

"Rule 142 (c).—Top leaf broken or leaves in top half or any three leaves in spring broken. (The long side of spring to be considered the top.)

"Rule 150 (a).—The minimum height of flange for driving and trailing wheel tires, measured from tread, shall be 1 in. for locomotives used in road service, except that on locomotives where construction will not permit the full height of flange on all drivers the minimum height of flange on one pair of driving wheels may be ¾ in."

PRELIMINARY LOCOMOTIVE DESIGN

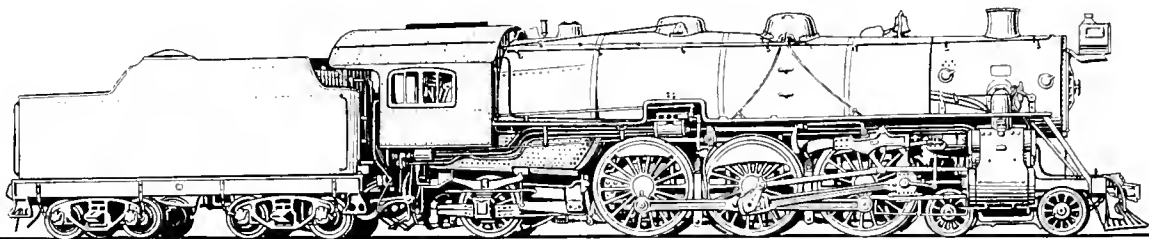

Methods Followed to Determine Size of Locomotives and the Fundamental Features of Their Design

BY W. R. MAURER

Mechanical Engineer, New York, New Haven & Hartford

At times railway mechanical officers are asked to submit a specification of a locomotive that will haul between certain terminals a "limited" passenger train within a specified time; to estimate how many cars this engine will haul in a slower or express service, also the size train it will haul in local passenger service as well as in various kinds of freight service. The proposition sometimes takes a different form, in which the mechanical man is asked to determine the time required by a specific locomotive to haul a specific train between certain points.

Many of the published processes are slow and cumbersome, requiring a succession of tedious calculations. The writer has tried to evolve some quick methods with results which are reasonably correct and at the same time which are based on accepted formulae. Certain of the assumptions used in these methods are open to criticism, but as the results are quite accurate there should be no hesitancy in their use.

Before the work on problems of this kind is begun, a profile and alignment showing the grades, the length and degree of curves of the roadbed over which the trains are to be hauled, a clearance diagram, weight limitations, if any, and an operating time table showing the speed and similar restrictions should be provided.

For example, let us suppose that it is desired to know:

(a)—The size of locomotive capable of hauling a train consisting of 10 steel Pullman parlor equipment cars between terminals *A* and *B*, in three and a half hours, making three station stops each of three minutes duration.

(b)—The shortest time that a Pacific type locomotive with 26 in. by 28 in. cylinders, 79 in. wheels, and 200 lb. boiler pressure can make the run hauling the same train.

(c)—The time that will be required for the above Pacific type locomotive to haul between terminals *A* and *B* a train of 12 steel passenger equipment cars, the train to consist of one baggage, one mail, one express, one smoker, three coaches, one diner and four parlor cars.

(d)—The tonnage rating of the locomotive given in (b) when hauling a fast freight.

Problems (b), (c) and (d) admit of direct solution but (a) must be solved indirectly; that is by assuming the size of cylinder, driving wheels and steam pressure and then use the same procedure as in problem (b). In making these assumptions it will be found expedient to determine graphically the tractive effort, from low speeds to the maximum that the locomotive is to operate, for locomotives having dif-

ferent sizes of drivers, cylinders, strokes and pressures, and from this graph select the one that seems to give the best results at the average speed the train is to be hauled.

TRACTIVE EFFORT AT DIFFERENT SPEEDS

First calculate the tractive effort according to the formula

$$\frac{d^2 \times L \times 0.85 \times P}{D}$$

Where: *d* = Diameter of the cylinders in inches.
L = Length of stroke in inches.
P = Boiler pressure in pounds per square inch.
D = Diameter of driving wheels in inches.

This gives the maximum tractive effort.

The tractive effort of a locomotive diminishes as the speed increases. An accepted method by which these decreases may be determined has been published by the American Locomotive Company in its Bulletin 1017. The maximum tractive effort is multiplied by a "speed factor" (see Table I) corresponding to the piston speed in feet per minute, to obtain the tractive effort at the speed in miles per hour at which the specific piston speed obtains. For convenience Table II is given here, which shows the piston speed at 10 m.p.h. for various lengths of stroke and diameter of drivers. For higher train speeds, increase the piston speeds accordingly.

The tractive effort at 10, 20, 30, 40, 50, 60 and 70 m.p.h. is found by multiplying the maximum tractive effort by the speed factors. By plotting these tractive efforts on cross section paper, the tractive efforts at any speed can be determined. By drawing on one chart the tractive efforts of several different locomotives, the advantages of one locomotive over another can be readily seen.

At slow speeds, the longer the stroke or smaller the driver, the greater the tractive effort, but as the speeds increase this ceases to be true and at high speeds and within reasonable limits the locomotive with large drivers and short stroke produces the largest tractive effort.

TRAIN RESISTANCE

All of the power of the locomotive is utilized in overcoming the resistance of itself and of the cars hauled. This resistance may be divided into six items as follows:

(a)—Engine friction or energy required to overcome the friction of the driving wheels, piston, valves, etc., is equal to the product of the weight on drivers in tons multiplied by 22.2 lb.

(b)—Grade resistance is equal to 20 lb. per ton multi-

plied by the grade in per cent. If the grade is expressed in feet use Table III.

(c)—Curve resistance is equal to 0.8 lb. per ton per degree of curvature or, roughly, is equal to increasing the grade in feet per mile by 2 ft. for each degree of curvature.

(d)—Resistance of the engine trucks, trailing wheels and tenders is assumed to be the same as on the cars in the train.

(e)—Car resistance for passenger cars may be obtained from Fig. 1; for freight cars from Fig. 2.

(f)—Head air resistance is equal to 0.24 multiplied by the square of the velocity in miles per hour.

The sum of these six items may be considered as the total

TABLE I—SPEED FACTORS

The tractive power of a locomotive decreases as the piston speed increases. For piston speeds over 250 ft. per minute, multiply the maximum tractive power by the factor corresponding to the piston speed given below:

Piston speed. Up to	Speed factor		Piston speed.	Speed factor	
	Saturate	Superheat		Saturate	Superheat
250	1.000	1.000	940	.441	.472
260	.991	.991	960	.432	.463
280	.972	.972	980	.422	.454
300	.954	.954	1,000	.412	.445
320	.935	.935	1,020	.404	.437
340	.917	.917	1,040	.396	.429
360	.899	.899	1,060	.388	.421
380	.881	.881	1,080	.380	.413
400	.863	.863	1,100	.372	.405
420	.844	.844	1,120	.365	.398
440	.826	.826	1,140	.358	.391
460	.808	.808	1,160	.351	.385
480	.790	.790	1,180	.344	.378
500	.772	.772	1,200	.337	.371
520	.754	.754	1,220	.331	.365
540	.735	.736	1,240	.325	.359
560	.717	.718	1,260	.319	.353
580	.698	.700	1,280	.313	.347
600	.680	.682	1,300	.307	.342
620	.662	.667	1,320	.302	.337
640	.644	.651	1,340	.297	.332
660	.626	.636	1,360	.293	.327
680	.608	.620	1,380	.288	.322
700	.590	.605	1,400	.283	.318
720	.573	.593	1,420	.278	.314
740	.556	.581	1,440	.274	.310
760	.546	.568	1,460	.270	.306
780	.532	.555	1,480	.265	.302
800	.517	.542	1,500	.261	.297
820	.505	.532	1,520	.257	.293
840	.494	.522	1,540	.253	.289
860	.483	.511	1,560	.249	.285
880	.471	.500	1,580	.245	.281
900	.460	.490	1,600	.241	.278
920	.450	.481			

resistance to be overcome, and can be safely used for summer conditions and good track. Cold weather, high winds and poor track will increase the resistance quite materially. (a), (b), (d) and (f) resistances are taken from the American Locomotive Company's Bulletin 1001. Grade resistance (b) is susceptible of accurate computation, being the ratio of

TABLE II—PISTON SPEED IN FEET PER MINUTE AT 10 M. P. H.

Driver Diameters	Stroke in Inches			
	24 in.	26 in.	28 in.	30 in.
50 in.	268.9	291.2	313.7	336.0
51 in.	263.6	285.6	307.5	329.5
52 in.	240.1	260.1	280.1	300.1
57 in.	235.9	255.5	275.1	294.8
62 in.	217.0	235.0	253.0	271.0
63 in.	213.4	231.1	249.9	266.7
68 in.	197.7	214.2	230.7	247.1
69 in.	194.8	211.0	227.2	243.5
72 in.	186.7	202.3	217.8	233.4
73 in.	184.1	199.5	214.8	230.2
76 in.	176.9	191.6	206.2	221.0
77 in.	174.6	189.1	203.7	218.0
78 in.	172.3	186.6	201.0	215.4
79 in.	170.2	184.4	198.6	212.7
80 in.	168.1	182.1	196.1	210.1

the distance the train is raised to the distance traveled. It may be either positive or negative depending upon whether the grade is ascending or descending. If descending then this resistance is to be either deducted from the total resistance or the available tractive effort is to be increased by this amount.

The passenger car resistance is taken from a paper by Prof. E. C. Schmidt and H. H. Dunn, an abstract of which

was published in May, 1917, issue of the *Railway Mechanical Engineer* on page 247. The freight car resistance is taken from Bulletin 43 of the University of Illinois, being a report of an investigation by Prof. E. C. Schmidt.

Acceleration.—In getting a train up to speed, the increasing resistance due to speed and the diminishing power of the locomotive prevent a uniform rate of acceleration, a

TABLE III—RESISTANCE IN POUNDS PER TON DUE TO GRADE

Resistance per ton is equal to 0.3788 lb. multiplied by the grade in feet per mile.

Grade (in ft.)	Resistance (lb.)	Grade (in ft.)	Resistance (lb.)	Grade (in ft.)	Resistance (lb.)
1	.379	21	7.955	41	15.531
2	.758	22	8.334	42	15.910
3	1.136	23	8.712	43	16.288
4	1.515	24	9.091	44	16.667
5	1.894	25	9.470	45	17.046
6	2.273	26	9.849	46	17.425
7	2.652	27	10.228	47	17.804
8	3.030	28	10.606	48	18.182
9	3.409	29	10.985	49	18.561
10	3.788	30	11.364	50	18.940
11	4.167	31	11.743	51	19.319
12	4.546	32	12.122	52	19.698
13	4.924	33	12.500	53	20.076
14	5.303	34	12.879	54	20.455
15	5.682	35	13.258	55	20.834
16	6.061	36	13.637	56	21.212
17	6.440	37	14.016	57	21.592
18	6.818	38	14.394	58	21.970
19	7.197	39	14.773	59	22.349
20	7.576	40	15.152	60	22.728

higher rate of acceleration being obtained at the starting, which is gradually reduced as the train gets under way. It requires about 100 lb. to accelerate or retard a ton of weight at the rate of one mile per hour per second. For passenger trains an average rate of acceleration and retardation due to grade can be assumed as 0.2 m.p.h. per sec., while the retarding effect on a train equipped with high speed brakes can be assumed at two m.p.h. per sec. Fig. 3 shows the distance traveled and time consumed in accelerating or retarding at a rate of 0.2 m.p.h. per sec. This acceleration curve is also used to determine the time required to accelerate passenger trains under ordinary conditions. Fig. 4

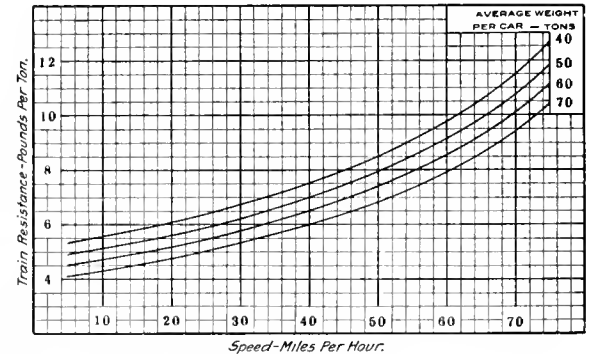

Fig. 1—Speed Resistance for Passenger Equipment Cars of Various Average Weights

shows similar information at a rate of 2 m.p.h. per sec. The abscissas represent the distances and seconds of time, while the ordinates represent the speed at each point. To determine the time required to accelerate from zero to 40 m.p.h., the vertical line passing through the point where 40 m.p.h. line intersects the curve is marked 200 seconds. At the bottom is shown that the distance traveled is 1 1/8 miles. In the same manner the time consumed and distance traveled from any speed to any other speed can readily be determined.

The distance required to make a stop from any speed by means of the emergency brakes is similarly found from Fig. 4. "Service" stops or slow-downs are made at a slower rate; approximately one mile per hour per second. This rate

requires twice the time and twice the distance to produce the results obtained at the two m.p.h. rate. All of the above curves are assumed as meeting the average conditions.

If more exact results are required it will be necessary to lay out curves for all rates of acceleration and to calculate the effects of the brakes from the braking condition on the cars, the kind of brake shoes, etc. A very complete discussion on Brake Performance* is given in a paper by S. W.

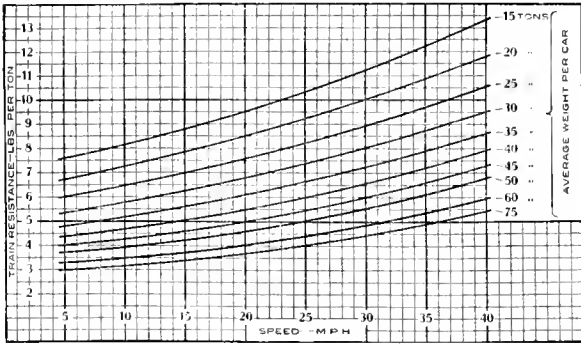

Fig. 2—Speed Resistance for Freight Cars of Various Average Weights

Dudley at the February, 1914, meeting of the American Society of Mechanical Engineers. Also see "Locomotive Operation" by G. R. Henderson.

It is to be remembered that to accelerate at a speed of 0.2 m.p.h. per sec. requires 20 lb. of tractive effort per ton of train, while the 0.1 rate requires half that amount.

Weather Conditions.—Cold weather decreases the tractive effort by decreasing the efficiency of the boiler as well as in-

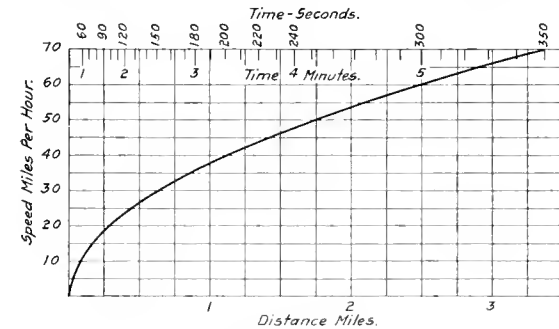

Fig. 3—Speed—Time—Distance Curve for an Acceleration Rate of 0.2 M. P. H. per Sec.

creasing the machine friction. Probably 5 per cent is ample to cover both. But the effect on car resistance is considerably higher. Prof. Schmidt in a paper before the Central Railway Club called attention to the fact that the cold had no effect on grade, curve, or acceleration resistance, but only affects the resistance on a straight level track at uniform speed. Therefore, the percentage reduction should not be as high on heavy grades as on low grades.

SPEED-TIME DETERMINATIONS

With a thorough understanding of the fundamentals given above, a curve can be drawn to show the maximum speeds for any locomotive hauling a given train over any piece of track. For example, consider the 26 in. by 28 in. Pacific locomotive with the 10 parlor cars mentioned above in

*An abstract of this paper was published in the *Railway Age Gazette*, Mechanical Edition, of March, 1914, on page 136.

problem (b). The following data is necessary for the determinations:

Tractive effort	40,800 lb.
Weight on locomotive drivers.....	83 tons
Weight of locomotive and tender.....	209 tons
Weight of trailing load.....	744 tons
Weight of total train.....	953 tons

By means of Tables I and II plot the tractive efforts from 10 to 70 m.p.h. in 10 mile increments (see Fig. 5). Then by means of the data given in paragraphs (a), (d), (e) and (f) determine the engine friction, car resistance (including the weight of the tender, engine truck and trailing truck) and head air resistance for the same speeds and subtract them from the tractive effort curve (Fig. 5), giving the tractive effort available for resistance due to grade (including curvature) and acceleration.

With this as a base every portion of the line should be studied to determine the time it will take for the train to pass

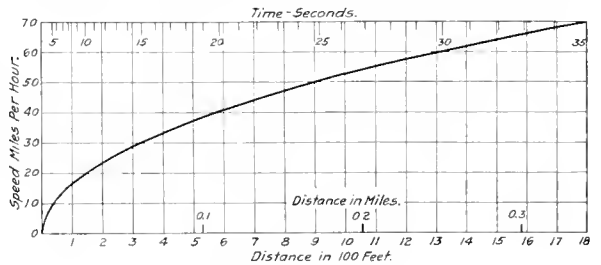

Fig. 4—Speed—Time—Distance Curve for an Acceleration Rate of 2. M. P. H. per Sec.

over it and the speed that may be attained throughout the different sections. Assuming that 60 m.p.h. is the limiting speed it will take 5 min. and 2½ miles to accelerate to that speed (see Fig. 3). Assuming further that from that point there is a 10 mile stretch of straight track, at the end of which there is a one per cent grade 5 miles long with 5 deg. curves, it will take 10 minutes to cover the straight track and the

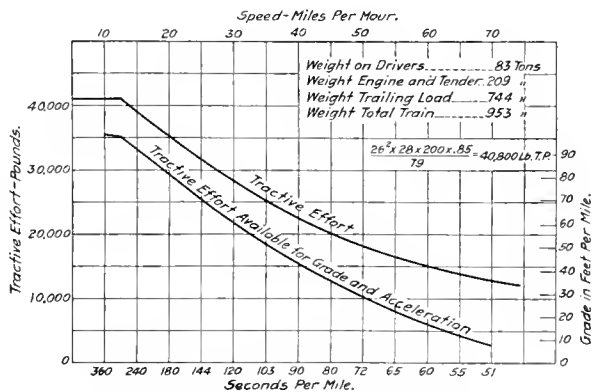

Fig. 5—Tractive Effort Diagram for Determining Maximum Speed at Which the Locomotive Can Operate

train will strike the grade at the rate of 60 m.p.h. The grade will require—

$$953 \times 20 = 19,060 \text{ lb.}$$

additional tractive effort and the curve will require—

$$953 \times 0.8 \times 5 = 3,812 \text{ lb.}$$

or a sum total of 22,872 lb. of tractive effort. This additional load will slow the train down to 38 m.p.h. (see Fig. 5), which will take 1 min. 50 sec., and distance traveled during that time will be 1½ miles (see Fig. 3). The remain-

ing $4\frac{1}{2}$ miles will be traveled at the rate of 38 m.p.h. or at the "balanced speed" and will be covered in—

$$\frac{4.5 \times 38}{60} = 2 \text{ min. } 51 \text{ sec.}$$

Thus it has taken the train—

$$5 + 10 + 1:50 + 2:51 = 19 \text{ min. } 41 \text{ sec.}$$

to cover the $17\frac{1}{2}$ miles to the top of the hill.

Exactly the same procedure is followed throughout the rest of the speed determinations, using Fig. 4 for determining time of retardation for the emergency application of the brakes and one-half these times for the service applications as explained above. For slow passenger or freight trains, acceleration or retardation values one-half of those shown in Fig. 3 should be used. When the entire division over which the locomotive with its train is to operate is thus analyzed the total time it will take to run the train over the division will be obtained and the speeds at the various parts of the division will be determined. This will give the *least* time required to make the run. In designing a locomotive for a specific train, liberal allowances should be made for slow orders, signals, etc., so that the locomotive will have sufficient reserve capacity to make up a reasonable amount of lost time.

DESIGNING THE LOCOMOTIVE

Let it be supposed that the locomotive to be designed is of the Pacific type, which has the following characteristics: Simple cylinders, 26 in. by 28 in.; drivers, 79 in.; boiler pressure, 200 lb. superheated steam; tractive effort, 40,800 lb.

Weight:—The weight on drivers should range from 4 to $4\frac{1}{4}$ times the tractive effort, which would be from 163,200 to 173,400 lb. on the drivers. The weight on drivers of a Pacific type locomotive is about 65 per cent of its total weight. Then the total weight would be between 252,000 and 267,000 lb. As the locomotive is to have a high steam factor the probable weight will be 267,000 lb., the balance of 93,600 lb. being equally distributed between the engine and trailer trucks. By moving the pins in the spring rigging the distribution may be changed somewhat.

Before proceeding too far a wheel spacing and load diagram should be submitted to the bridge engineer to determine whether or not the bridges will stand the proposed loading. Some bridge engineers have all the bridges on the line calculated in terms of some unit, such as Coopers E60. Then by computing the load diagrams of the proposed locomotive in the same terms, it can readily be ascertained if the proposed locomotive will produce stresses (moments and shears) that are above the safe limit. It was found that by changing the distribution of the loads to 50,000 lb. on engine truck and same on the trailer and 55,000 lb. on each of the drivers the bridge stresses would not be excessive, a variation of one to two per cent being allowed.

Boiler and Cylinders.—In locomotive design the two important elements are the boiler and cylinders, the work of the latter being dependent upon the former. It has been stated that the boiler capacity for a locomotive cannot be made too large, but when the weight of the locomotive is limited, then the importance of properly proportioning the boiler to the work it has to do is quite vital. In American Locomotive Company's Bulletin 1017, Mr. Cole gives some valuable data on boiler proportions upon which the following suggestions are based, the fundamental principle being that the boiler horsepower should about equal the cylinder horsepower.

The cylinder horsepower is computed from the formulae:

HP = .0212 PA for saturated steam.
 HP = .0229 PA for superheated steam.
 In which A = Area in square inches of one cylinder.
 P = Boiler pressure

It is assumed that 27 lb. of saturated steam are consumed

per horsepower hour, while for superheated steam 20.8 lb. are used.

The cylinder horsepower of a 26 in. diameter cylinder simple locomotive at 200 lb. boiler pressure is 2,434 and if superheated steam is used the steam consumption is $2,434 \times 20.8 = 50,627$ lb. Then the boiler must be capable of evaporating approximately 50,600 lb. of water per hour, provided the locomotive will not exceed the weight limitations. The grate area required is determined by dividing the horsepower by 30 for saturated steam or by 36.9 for superheated steam. The above locomotive, therefore, should have $2,434 \div 36.9 = 66$ sq. ft. of grate, although 60 sq. ft. will answer if a high grade of coal is used.

The determination of the number of tubes required is more or less complicated in so far as the amount of water evaporated per square foot is concerned. Short tubes are more efficient than long ones but not so economical on coal. The A. L. Co.'s bulletin 1017 gives a table of evaporative values of tubes and flues of varying diameters, lengths and spacing. As the tube spacing most often used is $\frac{3}{4}$ in. (that is the space between the tubes proper, not the bridges) and the spacing of superheated flues is generally 1 in., Fig. 6 has been prepared to show the pounds of water evaporated by tubes and flues of various lengths. It will be found that while more 2 in. tubes than $2\frac{1}{4}$ in. can be applied, thus providing more heating surface, the greater efficiency of the $2\frac{1}{4}$ in. tubes will more than make up this difference. It

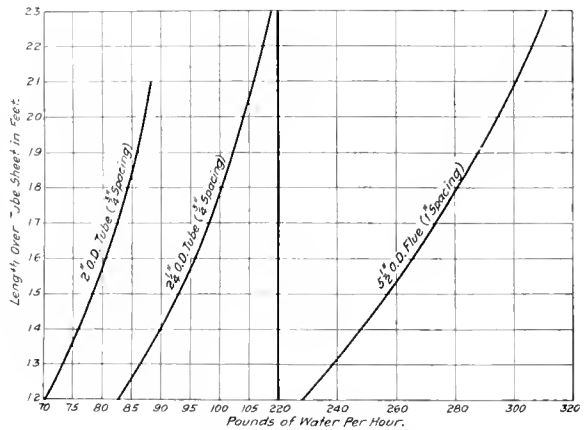

Fig. 6—Tube Evaporation Curves

will be noticed that the evaporation curves straighten as the lengths increase. It follows that the longer the boiler, the more it will weigh, not only on account of more metal but on account of the water as well.

Now the evaporation value of a square foot of fire box heating surface, including that of arch tubes and combustion chambers, is taken as 55 lb., which is at least five times that of a square foot of tube or flue surface. Therefore where the construction would require flues 20 ft. long or over without the use of a combustion chamber, by introducing a combustion chamber the tubes and flues can be shorter, the boiler horsepower will be materially increased while at the same time the weight of the boiler will be reduced.

The writer does not know the methods used by the Locomotive Superheater Company for determining the number of superheater units. It is, therefore, best to get their recommendation first. If time is limited the number may be taken from the published descriptions of similar locomotives. For the Pacific type locomotive which we are studying, let us assume that there are to be 36 $5\frac{1}{2}$ -in. flues, and that flues and tubes are to be 18 ft. long, the combustion chamber to be 3 ft., 6 in. long and 56 in. in diameter. This would give

a combined heating surface for the firebox, combustion chamber and arch tubes of 320 sq. ft., which multiplied by 55 lb. would give 17,600 lb.; deducting this from 50,600 lb. leaves 33,000 lb. to be evaporated by the tubes and flues. One 18-ft. 5½-in. flue (17 ft., 11 in. between heads) evaporates 280 lb. of steam per hour. The 36 flues will evaporate 10,080 lb., which leaves 22,920 lb. to be evaporated by the tubes. From Fig. 6 we find that one 2¼-in. tube, 18 ft. long, evaporates 100 lb. of steam per hour. Thus 229 tubes will give the remaining 22,900 lb. of steam and provide a 100 per cent boiler.

Good boiler design requires that the clearance between the

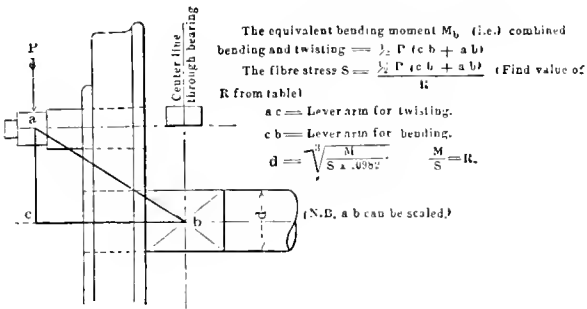

Fig. 7—Method of Calculating Driving Axles

shell and tubes shall not be less than 1¼ in. at the front tube sheet, and 1½ in. at the top, 1 in. at the sides, and 2 in. at the bottom at the back tube sheet. The 5½-in. flues should be spaced on 6½ in. centers and the 2¼-in. tubes should be spaced on 3 in. centers. A tube and flue layout for the front and back tube sheets should be made on tracing cloth and by superimposing the two layouts it will be easy to discover if a better scheme can be provided. After a careful study it is not unusual to increase the number of tubes a dozen or so. The distance from the crown to the roof of the boiler should be not less than 25 per cent of the outside

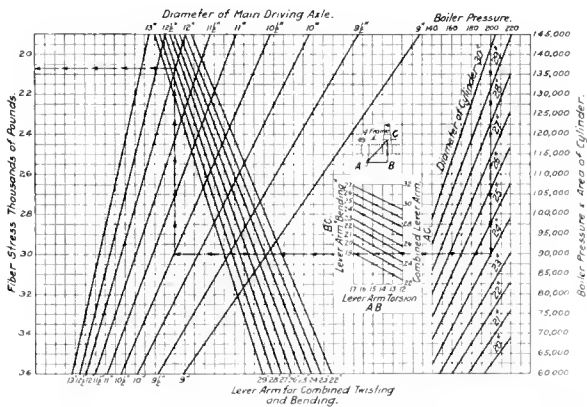

Fig. 8—Diagram for Determining the Fibre Stress for Any Given Driving Axle Diameter

diameter of the largest boiler course. From the foregoing it will be found that the outside diameter of the first course would be 78 in. and the diameter for the back course 88 in.

The boiler should be built with a factor of safety of not less than 4½. For a 200 lb. pressure boiler, a rough rule for estimating purposes is that with a sextuple seam the thickness of the shell is 1 per cent of the boiler diameter; of a dectuple seam 0.9 per cent; of a diamond seam 0.88 per cent. The throat sheet should be not less than 24 in.

deep in order to provide for a fairly thick fire over the grates.

As shown in the May, 1917, issue* of this journal, the efficiency of the boiler and the drawbar horsepower are greatly increased by the use of a brick arch. In designing the ash pan, the openings for the admission of air should be as near 15 per cent of the grate area as the construction will permit.

Frames.—While it is the common practice to use the same factors in designing Vanadium cast steel frames as is used for ordinary open hearth cast steel frames, the practice would seem faulty, as a material having a higher yield point should be stressed higher, thus deriving a benefit from the higher priced material. The writer has used the following with success in determining the sectional area at different points of frame:

	O. H. Steel	Vanadium
Top of pedestal.....	T × .0038	T × .0035
Top rail between pedestals.....	T × .0033	T × .0030
Lower rail between pedestals.....	T × .0022	T × .0020

In which T = piston thrust of one cylinder.

Axles.—Axle bearing pressures in pounds per square inch should not exceed the following limits:

	Passenger	Freight
Driving.....	175 lb.	200 lb.
Traveling.....	175 lb.	185 lb.
Engine truck.....	160 lb.	180 lb.

Driving axles are subjected to a variety of strains. The journals must be large enough to prevent undue heating and the diameters must be such that the fibre stresses, produced not only by the superimposed load but also by the torsional stresses caused by the pressure on the crank pin, must be well within the elastic limits of the material. The method for calculating the size of the axle is shown in Fig. 7.

In a paper on "Alloy Steel in Locomotive Design" read at the 1916 convention of the American Railway Master

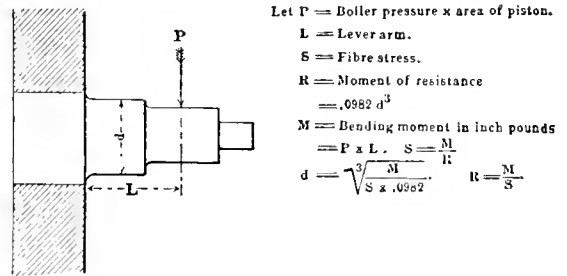

Fig. 9—Method of Calculating Crank Pins

Mechanics Association (see also *Railway Mechanical Engineer* for April, 1916, page 171, and *Daily Railway Age Gazette* for June 21, 1916, page 1499) by L. R. Pomeroy, a diagram (Fig. 8) for quickly determining fibre stresses and sizes for driving axles is given, this diagram being based on the generally accepted formulae shown in Fig. 7. The method of reading the diagram (Fig. 8) for main rods is indicated by the dotted lines. From the boiler pressure, found at the top, read down to the diagonal for the cylinder diameter, at the right of this intersection read the piston thrust or load on the pin, thence to the left to the lever arm A C (the diagonal distance between the center of driving box and main rod fit on crank pin), thence upward to the diameter, thence to the left find the fibre stress. In the same manner the fibre stresses in the other driving axles may be found, assuming that the thrust on the crank pin is 40 per cent of the weight on all the drivers actuated by the pin or assume some arbitrary percentage of the piston thrust.

To determine the crank pin stresses use Fig. 9.

Fibre stresses in driving axles made of open hearth steel having an ultimate tensile strength of 80,000 lb. and an

*Locomotive Brick Arch Tests—page 235.

elastic limit of about 40,000 lb. should not exceed 21,000 lb. per sq. in., while for crank pins the limit should be 15,000 lb. Should alloy steel with a higher elastic limit be used then the fibre stresses may be increased proportionately.

By hollow boring, the weight of driving axles and crank pins may be greatly reduced, without materially decreasing their strength. A 4-in. hole in a 12-in. axle reduces the weight 11 per cent, while its strength is reduced only slightly over 1 per cent. A 4-in. hole in a 9-in. axle reduces the weight 20 per cent, while its strength is reduced less than 4 per cent. Certainly an efficacious method of saving weight but at an increased cost.

Miscellaneous.—The question of correct balance is all important and closely allied with it is the question of the weight of the reciprocating parts. This weight may be reduced by the use of alloy steel. The formulae for determining the proper counterbalance may be found in the 1915 proceedings of the Master Mechanics' Association. Similar formulae are found in the Master Mechanics' proceedings for designing main and side rods. Care should be taken to avoid offsets in these members as well as in all motion work. The wheels should be located to provide sufficient clearance space between them and other parts of the locomotive.

The problem of determining the estimated weight of the locomotive and its distribution is difficult when the complete file of the weights of locomotive parts is not at hand. Probably the easiest way to determine this is to compare the proposed locomotive with another of the same type and for

which drawings and weight distributions are available, listing the differences in weight in "plus" and "minus" columns and in this way a fair estimate will be obtained. To determine with any degree of accuracy the distribution of weight on drivers and trucks, the center of gravity of the boiler and principal parts should be determined and their effect on the total weight distribution be calculated.

The capacity of the tender should be such as to meet the demands of the service in which the locomotive is to be used. The distance from the coal gate to the firedoor should be not less than 6 ft. or more than 6 ft. 6 in., and where there is no coal pusher the slope sheets should come within 14 in. of the coal gates and have an angle of 37 deg., so that the coal will feed to the coal gate without it being necessary to shovel it ahead. If the wheel base of the locomotive and tender has been determined, the longitudinal center of gravity should be found. Twice the distance from the center of gravity to the furthest wheel plus about 18 in. will be the diameter of the smallest turntable on which the locomotive can be turned.

No attempt has been made to go into the design of the locomotive in any great detail, as the limits of space forbid, but with the above, one should be able to make a reasonably accurate preliminary design of the locomotive, which, of course, is necessary before any definite arrangements are made. With the preliminary design determined upon, a finished locomotive may be designed by the use of good engineering practice.



FIREBOX TEMPERATURE EXPERIMENTS

Oil Burning Locomotive Tests Show Increases in Temperatures and Boiler Efficiency with Gaines Wall

FIREBOX temperatures—and particularly temperatures at different points in the firebox—is a subject of more than passing interest to railway mechanical officers; but, unfortunately, it is a subject about which little is known. The high-temperature thermocouples in use at the present time are impractical for road test purposes, so firebox temperature determinations have been confined to a few test plants, such as the Pennsylvania Railroad's Altoona plant, Purdue University and the University of Illinois. At these plants firebox temperatures have been determined in numerous tests, but the temperatures were determined at only one point, that generally being at the rear of the brick arch.

The Texas & Pacific recently had occasion to take firebox temperature readings at different points in the fire box, and some interesting data was obtained during the tests. The locomotives tested were of the 2-10-2 type, in oil-burning service, the size and design being indicated by the following data:

Gage	4 ft. 8½ in.
Service	Freight
Fuel	Oil
Tractive effort	62,700 lb.
Weight in working order	324,600 lb.
Weight on drivers	262,100 lb.
Weight on leading truck	27,100 lb.
Weight on trailing truck	35,400 lb.
Weight of engine and tender in working order	501,300 lb.
Cylinders, diameter and stroke	28 in. and 32 in.
Driving wheels, diameter over tires	63 in.
Working pressure	185 lb. per sq. in.
Boiler, outside diameter of first ring	84 in.
Firebox, length and width	176½ in. by 82 in.
Firebox type	Jacobs-Shupert
Tubes, number and outside diameter	267—2 in.
Flues, number and outside diameter	41—5¼ in.
Tubes and flues, length	38 ft.
Heating surface, tubes and flues	3,530 sq. ft.
Heating surface, firebox	307 sq. ft.

Heating surface, total	3,846 sq. ft.
Superheater heating surface	886 sq. ft.
Grate area	70 sq. ft.

FIREBOX TEMPERATURES.

The locomotive was equipped with a firebox of the Jacobs-Shupert type, 176½ in. long, there being a 42½ in. combustion chamber at the front end, separated from the main portion of the firebox by a Gaines wall with five 3-in. air ducts. The object of the tests was to ascertain the firebox temperatures at different points, in order to determine if there was any concentration or localization of temperatures above the Gaines wall or in the combustion chamber. Two series of tests were run—one with the Gaines wall in place and one with the wall removed.

Fig. 1 shows the general firebox layout, the wall being shown in dotted lines and the pyrometer locations being shown by small circles. Locations *A, B, C* and *D* show points at which temperature determinations were made with the wall in place, while *A', B', C'* and *D'* show locations of thermo couple with the wall removed. It is the usual practice to insert thermocouples in firebox by cutting a hole through the side sheets and placing a thimble therein to accommodate the thermocouple; but as this was not desirable in the present tests, the thermocouples were introduced into the firebox through holes in the combustion chamber floor and fire pan, the body of the thermocouple being protected from the flame by a water jacket.

Temperatures at the different points were obtained by the use of a Platinum Rhodium Thermocouple, used with a Leeds & Northrup potentiometer indicator. The instrument was furnished by the railway department of the University

of Illinois and the readings were taken by Professor J. M. Snodgrass, of that institution. As the type of instrument used is not of a sufficiently rugged character to withstand the jars and shocks of a road test, standing tests were conducted by removing the main valves and blowing all the steam generated through the valve chamber and out of the stack.

Four tests were run with the wall in place and four with the wall removed; and in order to make them strictly comparable, an endeavor was made to keep the oil fired during each test the same, by working the firing valve and the throttle in constant position. As the results show, however, this did not accomplish the desired effect, as a little more oil was burned without the wall than with it. A Louisiana fuel oil with a gravity of 24 to 30 and heat value of 19,332 B. T. U. per pound was used. The temperatures obtained during the tests are shown in Table I.

As a check on the temperatures obtained with the Leeds & Northrup pyrometer, a radiation pyrometer was used, this

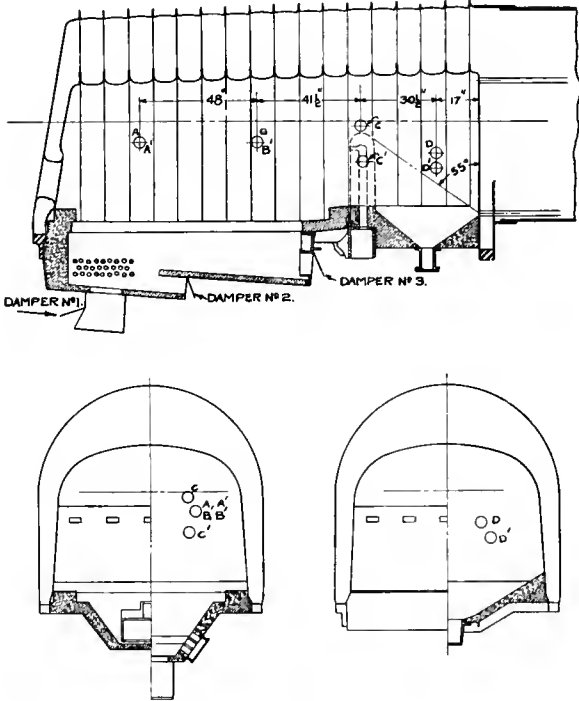

Fig. 1—Location of the Thermocouples in the Firebox.

being inserted through the sand hole in the firedoor. The temperatures registered by this instrument were nearly constant throughout the range of tests. In order to compare the standing test conditions with road service, two road tests were made, during which temperatures were obtained with the radiation pyrometer inserted through the door. The results of this test are also shown in Table I.

Fig. 2 shows graphically the maximum temperature ranges, with and without the Gaines wall, the average temperatures being 20 to 60 deg. lower than those indicated by the curves. It will be observed that with the wall in place, the highest temperatures were obtained in the back part of the firebox; and that there was a gradual drop in temperatures as the flames approached the flue sheet. With the wall removed, the temperatures in the rear and middle portions of the firebox were fairly uniform, with a decided drop in the combustion chamber space. At a point directly above the Gaines wall location, the temperatures were higher with the wall removed

than when the wall was in place, this being due to the fact that the wall has the effect of baffling the flames and throwing them back into the rear portion of the firebox where combustion is most intense; whereas with wall removed there was no such baffling effect and there was a noticeable short-circuiting of the flames from the burner over into the combustion chamber.

The temperatures shown are probably lower than might be expected in burning fuel oil under these conditions, but this can be accounted for in two ways:

First: The large volume of the firebox (433 cu. ft.)

TABLE I. AVERAGE TEMPERATURE AND DRAFT
STANDING TEST—ENGINE 511

Test No.	L. & N. Pyrometer Location	L. & N. Pyrometer		Radiation Pyrometer Through Door	Front End Temp. F°	Draft Ins. of Water		Pounds Oil Burned Per Hour
		Avg.	Max.			Fire Pan	Front End	
3	A	2,315	2,330	595	3.8	8.4	3,952
7	A'	2,006	2,040	2,000	645	4.1	8.9	4,164
2	B	2,056	2,140	2,045	...	3.0	7.8	4,008
6	B'	1,940	2,055	2,040	...	3.8	8.5	4,068
1	C	1,855	1,875	2,315	...	2.9	8.0	3,139
8	C'	1,966	2,020	2,015	625	3.9	8.3	4,261
4	D	1,580	1,645	2,025	590	3.8	8.5	3,607
5	D'	1,710	1,730	2,030	580	3.7	8.0	4,135

ROAD TEST—ENGINES 500 AND 511

Engine 511, with Gaines Wall	2,110	570	3.3	6.9	*2,157
Engine 500, without Gaines Wall	2,175	600	4.1	7.3	*2,982

Pyrometer Locations A, B, C and D are with Gaines Wall. Pyrometer Locations A', B', C' and D' are without Gaines Wall.

*Pounds of oil burned on trip Longview to Marshall, Tex.

reduces the heat liberation per unit of volume and therefore reduces the temperature. If the same amount of oil were burned in a firebox of smaller dimensions, the heat liberation per cubic foot of volume would be greater and the temperatures would be higher.

Second: The temperatures registered by thermocouples might be a little low, due to the fact that a thermocouple will radiate heat to a cooler object if brought sufficiently close. In the tests it was endeavored to keep the thermo-

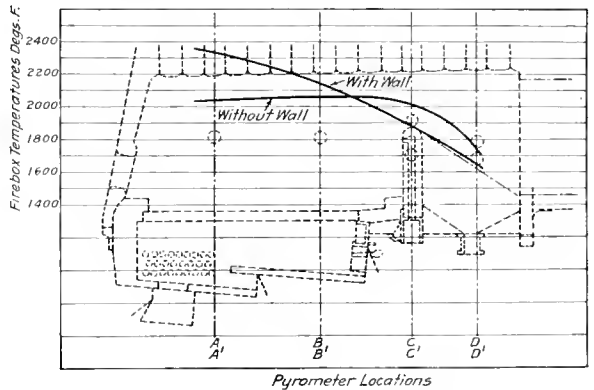

Fig. 2—Firebox Temperatures With and Without the Gaines Wall.

couple far enough away from the crown and side sheets to prevent this loss of heat by radiation; but it is barely possible that some radiation did occur, and that the temperatures registered are a little lower than the actual.

BOILER PERFORMANCE

Advantage was taken of the opportunity to make some determinations of the evaporative efficiency of a boiler, with and without the Gaines wall. The results of the test are summarized in Table II. With the wall in place, an average of 3,675 lb. of oil per hour was fired, with an apparent evaporation of 47,968 lb. of water; this being equal to an

evaporation of 13.05 lb. of water per pound of oil and 12.47 lb. of water per square foot of heating surface. With the wall removed and the same front end draft, the average amount of oil fired was 4.142 lb., with an apparent evaporation of 46,842 lb. of water per hour, or 11.3 lb. of water per pound of oil and 12.18 lb. of water per square foot of heating surface.

The boiler horsepower generated per cubic foot of firebox volume averaged about 4.2; while the equivalent evaporation per pound of oil averaged 17.03 with the wall and 14.8 without the wall, the corresponding boiler efficiencies being 85.5 and 74.5—or a difference of 13½ per cent. in efficiency, due to the Gaines wall.

The boiler efficiencies are high, considering the rate of firing; but it should be borne in mind that in burning oil there is no loss through grates and ashpan and no discharge of fuel at the stack in the form of cinders. With the wall in place, combustion was perfect; there being no indication of CO (carbon monoxide) in the flue gases, and no black smoke issuing from the stack at any time. Under these conditions, practically all the heat loss will be accounted for in the front end gases; and, as shown in Table I, the front end temperatures were uniformly low, considering the length (18 ft.) of the flues. With the wall in place, the average front end temperature was 585 deg.; without the wall, 615 deg.; a difference of 30 deg., which accounts for a part of the efficiency shown by the wall.

With the wall removed, smoke emission was very noticeable; and there was considerable fuel wasted, due to the

face and large firebox volume will absorb more heat than a similar firebox without a combustion chamber, thereby reducing the temperature of the gases entering the flues. Since, under a given set of conditions, there is a direct relation between the temperature of the gases entering the flues and leaving at the front end, this results in lower front end temperatures and higher boiler performance.

CONCLUSIONS

The following conclusions may be drawn from the results of these tests:

When burning oil, there is no localization or building up of temperatures above the Gaines wall, the highest temperatures being obtained in the back of the firebox and gradually decreasing as the flames approach the flue sheet.

Without the wall, temperatures are more uniform from the door to the combustion chamber, with a decided drop in the combustion chamber. The temperatures above the wall location were higher without the wall than with the wall in place.

Removal of the wall causes a decrease of 13½ per cent. in evaporative boiler efficiency. This is accompanied by an average increase of about 30 deg. in the front end temperatures and a noticeable increase in the amount of smoke.

The wall seems to have little or no effect on the superheat in steam, as these temperatures average from 225 to 230 deg. with the wall in place to 225 to 235 deg. with the wall removed.

The indications are that with a combustion chamber fire-

TABLE II—EVAPORATION, BOILER HORSEPOWER AND BOILER EFFICIENCY

Test No.	Oil—Gaines Wall	Oil—		Water—Apparent Evaporation			Equivalent Evaporation From and at 212 deg.			Boiler Horsepower		Boiler Efficiency
		Lbs. Fired Per Hr.	Per Cu. Ft. Firebox Volume	Lbs. Per Hr.	Per Lb. of Oil	Per Sq. Ft. Evap. Surf.	Lbs. Per Hr.	Per Lb. of Oil	Per Sq. Ft. Ht. Surface	Total	Per Cu. Ft. Firebox Vol.	
1	With	1,139	7.25	41,697	13.25	10.84	54.06	17.30	11.45	1,571	3.63	86.8
2	With	4,004	9.25	52,720	13.16	13.70	68,536	17.11	14.48	1,986	4.59	85.8
3	With	3,956	9.12	50,241	12.17	13.06	65,815	16.65	16.65	1,907	4.40	83.5
4	With	3,607	8.33	47,216	13.09	12.27	61,852	17.14	13.07	1,792	4.13	86.0
Ave.	With	3,675	8.49	47,968	13.05	12.47	62,602	17.03	13.22	1,814	4.19	85.5
5	Without	4,135	9.56	47,500	11.48	12.35	62,225	15.05	13.45	1,804	4.16	75.5
6	Without	4,008	9.25	46,036	11.48	11.97	60,307	15.04	12.74	1,748	4.03	75.5
7	Without	4,164	9.61	44,607	10.71	11.60	58,435	14.03	12.35	1,694	3.91	70.4
8	Without	4,261	9.84	49,227	11.55	12.80	64,487	15.13	13.62	1,869	4.31	75.9
Ave.	Without	4,142	9.59	46,842	11.30	12.18	61,363	14.81	12.96	1,779	4.10	74.3

short-circuiting of the oil from the burner into the lower flues, partly unconsumed. Calculations based on the rate of flow of heat through fire brick and boiler lagging indicate that less than 1 per cent. of the fuel used was lost by radiation through the pan and through the boiler lagging.

AIR SUPPLY

Air used for combustion was drawn in through dampers 1 and 3, the pipe thimbles in the rear of the fire pan and the air ducts in the Gaines wall, as shown in Fig. 1. Damper 2 was kept closed during the tests, as it was found that air admitted at this point caused a violent drumming in the firebox. The total effective air opening was 540 sq. in., and this was found sufficient to burn 4,000 lb. of oil per hour without making smoke. The gas analysis indicated an air excess of about 40 per cent.

FRONT END TEMPERATURES

The relatively low front end temperatures obtained show clearly that the long flues are not necessary for low front end temperatures and high boiler performance. These engines had flues 18 ft. long; and the results show that a flue of this length, used in conjunction with a firebox equipped with a combustion chamber of ample length and volume, will give as low front end temperatures as longer flues used in conjunction with a firebox without a combustion chamber. This is due to the fact that a firebox equipped with combustion chamber and providing a large area of heating sur-

face of this type, with an air opening of one square inch per gallon of oil burned, 4,000 lb. of oil can be burned per hour without making smoke. Without the wall, considerable smoke was made at this rate of firing.

Firebox volume is a very important factor in burning oil. These tests indicate that not more than 9 to 10 lbs. of oil per cubic foot of firebox can be completely burned per hour. This is equivalent to 4 to 4½ boiler horsepower per cubic foot of firebox volume.

Furnace conditions with the Gaines wall in place are almost perfect; and with firing of ordinary intelligence, these locomotives can be driven to maximum capacity with high boiler efficiency and without smoking.

The firebox temperature determinations made in these tests open up a new and unexplored field of research work, which if followed out will add greatly to our rather limited fund of knowledge and will remove much of the guess-work that is now involved in firebox and boiler design.

It should also serve to stimulate the design and manufacture of high-temperature thermocouples, and ultimately result in the evolution of an instrument that is reliable and rugged enough to make firebox temperature readings under road service conditions.

CANADIAN RAILWAYMAN HONORED.—Lieut.-Col. C. W. P. Ramsay, chief engineer for construction, Eastern lines, C. P. R., and now with the Canadian Army in France, has been made a Companion of the Order of St. Michael and St. George.

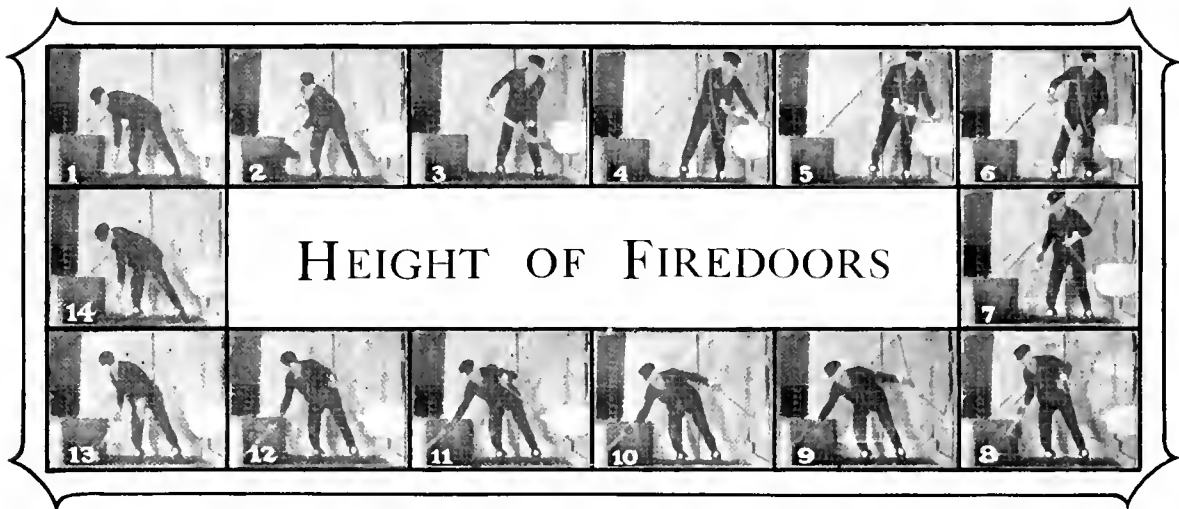

HEIGHT OF FIREDOORS

THE fact that the distance from the cab deck to the bottom of the firedoor varies on our modern locomotives from $17\frac{1}{2}$ in. to 26 in. shows that no very great consideration has been given to this particular feature of locomotive design. It has, however, an important bearing on efficient locomotive construction, for with an improperly located firedoor the fireman cannot perform his work efficiently. In order to determine as near as possible the proper height at which the firedoor should be located, the Pennsylvania Railroad conducted some unique tests at its Altoona test plant which give without question the most authoritative information on this subject. These tests show that regardless of the height of a fireman, freer action of the arms and body will be obtained with the bottom of the firedoor located 22 in. above the cab deck and that the coal should always be within reach of the fireman.

The tests were made on a firing platform which had the dimensions of the cab and tender of a class L-IS (Mikado) locomotive, the back head of the boiler being arranged so that the firedoor could be raised or lowered by the man shoveling the coal. The coal was placed on the platform at about the same location as the coal gates on the locomotive. The box that corresponded to the grates was given the same slope as on the locomotive and an improvised brick arch was used, being properly located with respect to the grates and back head of the boiler.

Twenty-four road firemen, six from passenger and six from freight service on two divisions, were called in to operate on the test platform. Each man fired coal for intervals of 15 minutes at firing rates of 5,000 and 9,000 lb. of coal per hour. They were instructed to set the firedoor at the height which best suited them. The results of these tests were plotted and it was found that with the two rates of firing, the desired height of the firedoor above the cab floor varied between 18

	Number of Men	Average Height of Firedoor	
		5,000 lb. Rate	9,000 lb. Rate
Division A firemen.....	12	22.89 in.	22.69 in.
Division B firemen.....	12	22.93 in.	23.01 in.
Special firemen.....	6	20.66 in.	20.85 in.
Average.....		22.46 in.	22.21 in.

in. and 25 in. No definite relation between the height of the men, which varied between 5 ft. $5\frac{1}{2}$ in. and 6 ft. 3 in., and the height of the firedoor could be found. Some special duty firemen and the test plant firemen, who were taller than the road men, preferred a low door. It was also found that those men who had been operating engines with high firedoors were

generally higher in their choice than those operating locomotives with the low firedoors. The average height of the firedoor chosen in these trials is in the table.

MOTION PICTURE STUDIES.

In addition to these tests an analysis of the movement of three expert firemen when firing with the bottom of the firedoor set at heights of 18 in., 22 in. and $25\frac{1}{2}$ in. above the cab deck were made from motion pictures taken during the operation. The firemen were 6 ft. tall and fired at the rate of 5,000 lb. of coal per hour.

The film showed approximately 75 positions of the fireman during a complete cycle, i. e., from the time coal was taken from the firing platform, delivered to the firebox and the shovel returned to the coal pile on the platform. From the film, which had been previously exposed to specially prepared co-ordinate paper, the path traveled by any portion of the fireman's body could be plotted. The photographed images of miniature incandescent lamps fastened to the head, wrists and ankles of the fireman, gave definite reference points on each of the 75 pictures, from which the paths traveled by these parts of the body were subsequently plotted. A sample of the films obtained is shown at the head of this article.

The path traveled by the head, which represents the movement of the man's back, and that traveled by his left hand, which opens and closes the firedoor and lifts the shovel, have been plotted for the three heights of firedoor in Figs. 1, 2 and 3. Only that portion of the movement during the delivery of the coal from the firing platform to the firebox is shown on these sheets. The three lower curves on these sheets represent the path of the left wrist of each of the men, while the three upper curves represent the movement of the head.

Referring to the lower curves, the firedoor chain was released at point X after the firedoor was opened. The path X to A was a free movement of the hand; the hand grasped the heel of the shovel at A, the shovel was lifted from A to B, the shovel full of coal was moved from B to C nearly horizontally toward and through the firedoor to the firebox.

The upper curves R to S represent the path traveled by the man's head during the time that his left hand was traveling the path X A B C. In discussing the curves, the center line P Q of the firedoor will be taken as the reference line as it lies midway between the upper and lower limits through which the coal must pass.

Firedoor 22 in. Above Deck Plate.—In Fig. 1 are shown the paths traveled by the head and left hand of the three fire-

men with the firedoor set 22 in. above the deck plate. An analysis of these curves and those determined when the fire-door was set 18 in. and 25½ in. above the deck shows the probable reason for the thirty firemen choosing an average height of firedoor above deck of 22 in. It will be noted in Fig. 1 that the expert firemen all lifted the coal to approximately the same level, *B*. The horizontal difference in the position of the left hand after the coal was lifted from *A* to *B* and in the location of point *R* of the head curves, was due to the difference in the reach for coal. It will be observed that the point *B* in the hand curve in Fig. 1 is slightly above the center line of the firedoor.

As the horizontal movement shows a tendency to be parallel to the line *PQ* from *B* to *C*, it seems that the location of point *B* determines the natural height *AB*, to which the coal would be raised during its delivery. Otherwise stated, the height *AB* is the natural vertical lift and ordinarily will be approximately the same height regardless of the height of the firedoor. The curves *RS* show a natural movement of the back. There is a uniform rise from *R*, where the head is at its lowest position, to *S* the point of maximum height. The head curves indicate that the man's back was gradually straightening during the delivery and taken in conjunction with the lower (wrist) curves, indicate that the lifting of the

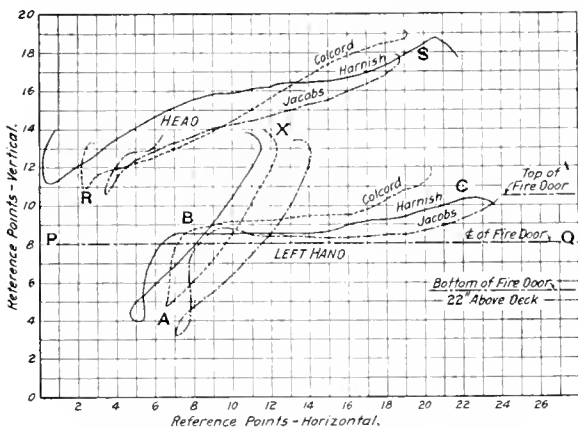

Fig. 1. Analysis of the Motion of the Head and Left Hand When Firing Through a Firedoor 22 in. Above the Cab Deck

coal from *A* to *B* and the delivery from *B* to *C* was accomplished by muscular action of both arms and back.

Firedoor 18 in. Above Deck Plate.—The paths of the head and left hand when the firedoor is set 18 in. above the deck plate are given by the curves in Fig. 2. Here the vertical lift *AB* is different for each fireman, although all raised the shovel from approximately the same point *A*. Fireman Jacobs raised the coal approximately the same height as he did for the 22-in. door, and in his horizontal movement gradually lowered his left hand until near the point where the coal left the shovel. His head curve is similar to the one for the 22-in. firedoor. The head and hand curves for fireman Jacobs when firing through the 18-in. firedoor, are similar to those on the 22-in. firedoor, but at the lower height of door there is more bending of the knees during the delivery from *B* to *C* and in this respect his position is more cramped than when the firedoor is 22 in. high.

Firemen Colcord and Harnish did not raise the coal as high in this case as they did for the 22-in. firedoor; the path of delivery *BC* is similar to the one for the 22-in. firedoor, but the back movement appears unnatural and indicates that they crouched more or less while working and that there was little back movement while the coal was traveling the path *ABC*.

Firedoor 25½ in. Above Deck Plate.—The curves when

firing with the firedoor 25½ in. above the deck plate are shown in Fig. 3. All the men lifted the coal approximately the same height *AB*; the maximum height *B*, at the initial lift was below the center line of the firedoor. The horizontal movement *BC* shows a greater rise than for the lower height doors. This movement must have been a combination of

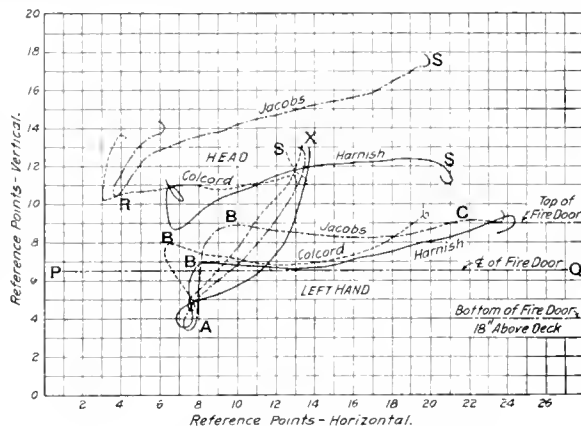

Fig. 2. The Same as Fig. 1 for the 18-in. Height

muscular effort, to raise the coal to and above the reference line *PQ*, and pivot action of the arms.

The motion pictures from which the curves were plotted show that there was a decided upward movement of the right hand near the point where the coal left the shovel, this movement being necessary in order to lower the bowl of the shovel. This upward movement of the right hand was not so noticeable when firing through the 18-in. and 22-in. doors.

CONCLUSIONS

It appears from the motion study that with the bottom of the firedoor 22 in. above the deck plate, the fireman lifts the

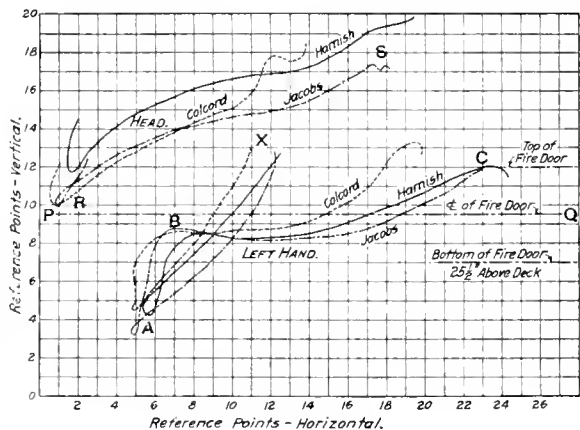

Fig. 3. The Same as Fig. 1 for the 25½-in. Height

coal with greater ease due to the combined muscular effort of the back and arms and the movement in delivering the coal is more uniform. False movements of the shovel are a minimum. With this height the coal is lifted to a natural height, *B*, and there is a natural use of the delivery curve *BC*, due to the pivot action of the arms at the shoulders. This height of door will be satisfactory to the average fireman as was shown in the firing tests in the laboratory.

As disclosed in all three of these plots, location *A*, the position of the left hand when lifting the scoop of coal should be the same for each action regardless of the firedoor height.



STEEL CAR SHOP OF THE E. J. & E.

Methods Used to Increase the Capacity of the Plant
 Interesting Application of Some Portable Riveters

MANY railroads at this time find themselves confronted with the necessity of increasing the output of the car shops in order to furnish the rolling stock required to handle the present heavy traffic. With tools, materials and men so hard to get, the problem is by no means an easy one to solve. The way in which the Elgin, Joliet & Eastern increased the capacity of its plant for repairing steel cars at Joliet, Ill., is therefore of particular interest.

Under normal conditions the repair tracks formerly made

These sections consist of 12 tracks, each having a capacity of about 13 cars. When the cars are set on any of the tracks for repairs they are not moved until all are finished. About two days are usually allowed for stripping, two for reassembling and two for painting the cars, but this allowance is increased when new sills are required.

The cars on which the majority of the work is being done are of two different designs, one a side dump car, shown in the process of stripping in Fig. 1, the other a bot-

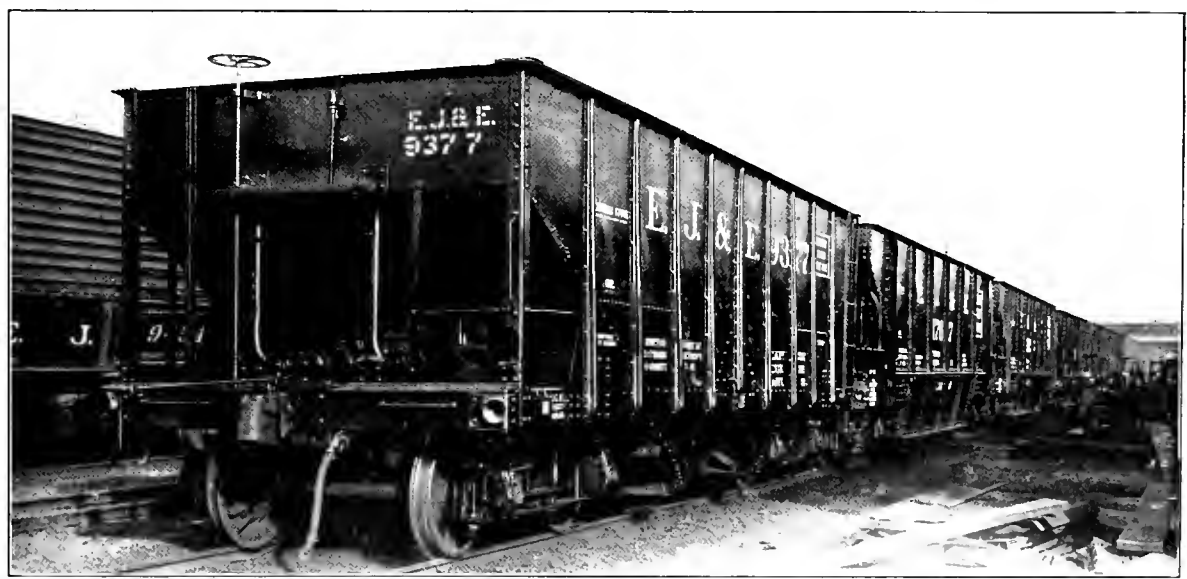

The Day's Output Ready to Leave the Repair Track

heavy repairs to about 100 steel cars each month. The great increase in the ore and coal traffic made it necessary to keep every available car in service and plans were made for increasing the capacity of the plant to handle about 200 cars a month. The capacity of the tracks was about 180 cars and this was increased to about 320 cars by adding 11 short tracks to the repair yard. Narrow gage tracks were arranged to serve the repair tracks, one being placed between every second track and one running transverse, across all the tracks. Sheds open on the sides, with louvers to admit light and air, were built to cover half the tracks.

For purposes of organization the repair yards are divided into two sections, each under the supervision of a foreman

tom dump, shown in Fig. 2. Most of these cars were built 14 or 18 years ago and are receiving their first overhauling.

As soon as the cars are placed on the repair tracks they are inspected to determine what parts are to be removed. The majority of the sheets are 5/16 in. thick when new and they are renewed if the thickness is 3/16 in. or less. The principal parts of the cars which require renewal are the side sheets, dump doors and floor sheets. These parts are made in quantities and carried in stock for all classes of cars. All rivet holes are punched according to templets and reamed after being placed in position. Dump doors, sills, etc., are assembled complete ready for application.

The shop was well supplied with punches and shears,

there being 12 of these machines ranging in size from 21 in. to 56 in. There were also two coping machines, one double angle shear, one 200-ton hydraulic press and three drill presses.

Since the forming operations could not all be done on the

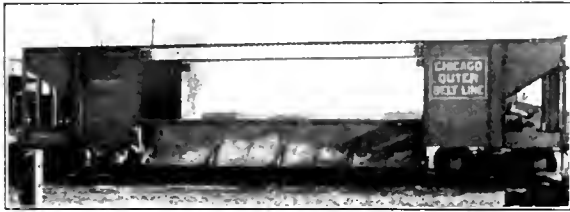

Fig. 1—Side Dump Car Being Stripped for Repairs

hydraulic press it was necessary to provide some means of doing this work. The pneumatic press designed for this purpose is shown in Fig. 3. A double-acting air cylinder operates the bar, the height of which can be adjusted at



Fig. 2—Bottom Dump Car Ready for the Application of New Sheets

either end. Formers of various types have been developed for use with this device, thus adapting it to a wide range of work. In the illustration it is shown closing up the end of a channel which forms part of a bolster.

The riveting of the dump doors and similar parts is han-

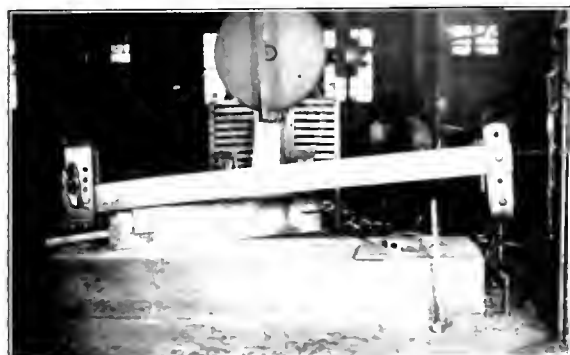

Fig. 3—Pneumatic Forging Press Adapted to a Wide Range of Work

dled in a novel manner. The method used on dump doors is illustrated in Fig. 4. After the doors are assembled trunnions are bolted on each end near the center. The doors are then placed on horses directly under a portable air riveter, being supported by the trunnions, while a hinged dog

attached to one of the horses keeps the door from turning on its supports. The riveter is supported overhead on a rail, along which it can be moved, while the height is adjusted by a chain hoist. When the rivets in the upper half of the door have been driven it is revolved on the trunnions to bring the other end up. In this way it is possible to handle the work with riveters having a reach equal to only one-half the width of the parts which are riveted. The work is done more rapidly than where air hammers are used and much better workmanship is secured.

The application of the air riveters to the riveting of center

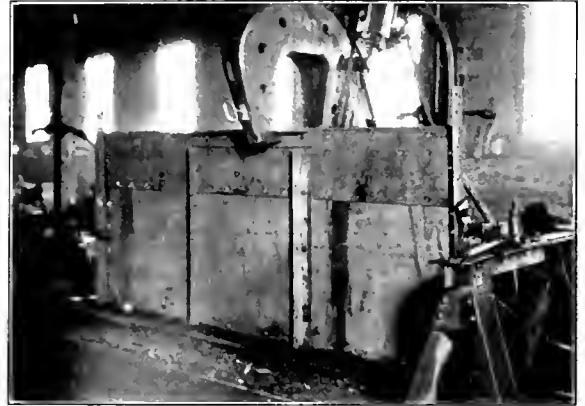

Fig. 4—Riveting Dump Door on Trunnion Supports

sills is shown in Fig. 5. Here the riveter is suspended at a fixed point and can only be moved vertically. The work after being assembled is mounted on strong push cars and moved along under the riveter. Some of the push cars are fitted with trunnion supports and in case all the doors cannot be handled on the horses some are mounted on cars and finished at the stationary riveter.

The assembling of the cars is done by gangs consisting of

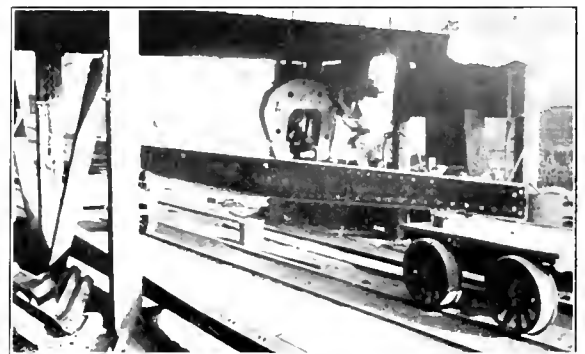
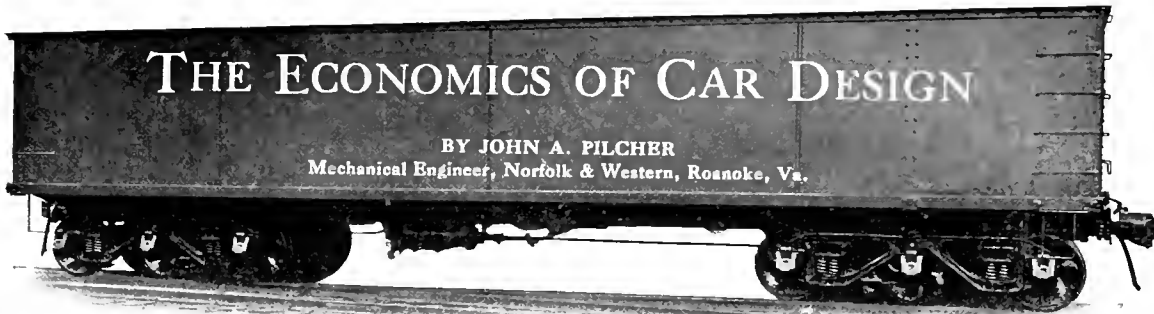

Fig. 5—Method of Handling Center Sills in Pneumatic Riveter

four fitters and two riveters. The parts are placed in position by the use of cranes and jacks and riveted with air hammers. The exterior is then given two coats of paint.

The work that is being done on the E., J. & E. is a splendid illustration of what can be accomplished under the present conditions to get greater production from labor and tools. The increase in the output of the shop is due to the ingenuity that has been used in designing special tools for the more important work, in devising effective methods of using the class of equipment that was available, in arranging for producing parts in quantities, and in maintaining a definite system for routing parts through the shop.



WHEN consideration is given to the very large number of freight cars built from a single design, the importance of giving careful study to each detail is readily understood. Every small saving that can be made in the labor of construction, each slight saving that can be made in the weight of the material, and every case where unnecessary material is used, as well as every slight defect, is multiplied by a thousand, in many cases by two or three thousand, or more. The large expenditure of money involved in the building as well as in the operation and upkeep of the cars which may be represented by a single design, justifies the thought of the best designers for an unlimited amount of their time.

The writer has a case in mind in which the slight shifting of the location of two rivets in a single detail, used several times on the car, made a difference in the cost of an order of 1,000 cars or more than \$2,000. How easy it is for the draughtsman or designer to let such a small matter go, rather than to take the time to make a slight change, which in this case had no influence whatever on the strength or maintenance of the structure, overlooking the extent to which his time will be repaid by the slight saving in the cost of the detail involved when such a large multiplier is used!

An experienced and enthusiastic car designer once said to the writer that he could take any car design, whether made by himself or another, and by again carefully going over every detail, save enough on an order of 1,000 cars to pay himself handsomely with 10 per cent of the reduction in the cost of construction, without reducing the strength of the structure in any way.

WHY THE RAILROAD SHOULD DO ITS OWN DESIGNING

The design for any type of freight car may be laid out along many different lines, each of which must be developed in great detail, and some in complete detail, before a proper and intelligent selection of the best for the purpose can be made. When the general type of construction has been determined there are then a large number of details, each of which should be given careful study from many angles. How is this study to be made? Who is to make it?

At the outset it must be clear that time is a most essential element in the solution of the problem, no matter to whom or what agency the task is to be given. No one can make a comparative study of several types of construction, each involving many details, without a liberal allowance of time. Such an allowance of time can only be had when the designer has his problem before him well in advance of the actual requirements of the equipment. This work must be done before the production of the working drawings becomes necessary.

Rushing through the design of a new car in order that the material may be ordered for quick delivery and the

contract brought to an early completion is probably the most prolific of all sources of unnecessary expense, both in first cost and maintenance. It cannot be expected that each of the many car-building organizations will maintain a sufficient staff, necessarily getting its information second-hand, to make an advance study of the many special needs of each railroad that may become a purchaser of cars.

In many cases the result is that plans are quickly prepared to meet an early date set for the receiving of bids, and regardless of the ability and experience of the designer, it invariably is found in such instances that less material could have been used with even greater strength or that there are real weaknesses in the design which could have been made amply strong without the use of additional material. Neither the bidder who fails to secure the contract nor the successful bidder has the time or opportunity to modify the design after the contract is let. Any change then made brings about correspondence, adjustment of price and delay.

For the following reasons, therefore, any railroad ordering as many as 1,000 cars of the same type at one time is fully justified in maintaining its own engineering force, made up of as many men as can be used, and in holding the best men who can be obtained:

(1) The men in this organization can easily be kept informed as to the probable special needs of the road. They can be preparing to anticipate these needs and experimenting with the equipment with that end in view. They may thus have definite general plans formulated and ready when the need arises.

(2) They have opportunities for first-hand information as to the relative effectiveness of different types of equipment and details under the service conditions of their own road.

(3) They are in a position to appreciate fully all phases of the problem, whether it be low first cost of construction, which means light weight and, therefore, low cost of operation, or low cost of maintenance, which means ample structural strength and proper provision for deterioration.

(4) They are also in a position to keep in close touch with the methods and appliances used in the road's shops, keeping these in mind when the design is made in order not to require the introduction of new methods or tools unless necessary; they are also in a position to know what older or standard parts should be retained in new designs. Frequently much money is expended in constructing a difficult detail in the shops, which could have been saved had the designer been familiar with his shop equipment.

(5) The railroad by going into the market to purchase a specific design completely worked out in detail, with complete specifications, receives the advantage of real competition, as the only considerations are the reliability of the bidder and the price. This also effects a large saving of

time, as each bidder is not required to prepare a new design before making the estimate.

The economic and engineering problems of freight car design are primarily two—cost and strength. While here considered more or less separately, they cannot properly be considered separately when an actual design is being worked out.

STRENGTH AND COST OF MAINTENANCE

Some years ago there came into the office of the writer an old man, an engineer representing a manufacturer of a device for railway use. In the course of his conversation he made the statement that when a young man he had been told by an older man always to be sure that he made everything very strong. If a structure never broke down its cost was never questioned in after years, but if it proved to be not strong enough it would always stand as a record against him. If an engineer is preparing a design for a single structure and the factors limiting the strength are difficult and expensive to determine closely, he is justified in insuring safety even at considerable extra expense over what might be a perfectly safe design, were a more accurate knowledge of the stresses available. To handle a problem in freight car design in this manner, however, is not engineering at all. The commission to design a freight car, when large numbers are to be built from the design, warrants all the diligence and expense necessary to determine with certainty the limitations within which the strength of the design must come in order that the weight and corresponding first cost, cost of maintenance, and cost of operation, may be properly compromised.

There are certain details of the car, both the truck and body, that are either fixed as standard or recommended as good practice by the Master Car Builders' Association. Where the standard has been established, as in the case of the axles, brasses, boxes, brake shoes and heads, couplers, brake pins, etc., any departure, even for special cars, must be carefully considered to avoid all complications and delays under the M. C. B. rules of interchange.

Recommendations in the matter of practice take care of nearly all other truck details, either fixing the tests they must withstand or space they may occupy, or both. To the springs, however, I wish to call especial attention. They should be of such capacity that under no conditions of operation will they ever go solid. The solid closing of the springs puts stresses in other members of the truck which they are not designed to take and which cannot be predetermined. Inattention to this matter may lead to broken side frames and bolsters.

In the car body construction the coupler and its location are practically the only important exact standards adhered to. Since the stresses in the body structure are of such an indeterminate character, depending so largely on the treatment the car receives in service, the Master Car Builders' Association has placed recommended minimum limitations for the construction of the center sills, to discourage the building of cars not sufficiently strong to be used without trouble in interchange traffic. The recommended minimum is based upon a maximum load in the center sills of 500,000 lb., and a combined maximum fibre stress due to this load of 30,000 lb. per sq. in. The minimum sill area is placed at 24 sq. in., the ratio of stress to end load at .06, and the maximum unsupported length of the center sills at 20 times the width. It may be stated in passing that this should also apply to the depth.

It is fortunate that the car designer has a measure of the buffing stresses fixed for him, as no construction he may use will insure freedom from failure if the cars come together at sufficient speed.

It is not the purpose of the writer to go into the details of construction. There are, however, a number of funda-

mental considerations which the designer should keep in mind as a means of properly directing his study, which it may be well to point out.

(1) Every stress imposed upon the car from without as well as every stress set up in the car from the load it carries, or from changes of speed or direction while either loaded or empty, sets up a reaction at one or more points in the car and must be resisted in some way. This is so fundamental as hardly to need statement, and yet it requires the closest study to determine all the points of reaction and all the effects of a stress. All the vertical and lateral forces must finally be transferred to the rail. All the longitudinal forces must either be passed on to an outside object, absorbed as work done within the car structure or taken up by the friction of the moving car. Keep in mind the fact that all forces act in straight lines.

(2) In considering longitudinal stresses, the limit of which cannot be definitely determined, there should be a progressive selection of the order in which the parts should fail. For example, the knuckle should break before the coupler, as it is easier to replace. The coupler possibly should break before the coupler attachments, and the attachments certainly before the center sills. If the coupler shank has a section of 15 sq. in. it might be well to put 20 sq. in. in the coupler attachments, particularly to resist the buffing stresses, and thus lead up to the 24 sq. in., which is the minimum recommended practice of the Master Car Builders' Association for the center sills.

(3) Where contact surfaces are in constant motion under heavy pressure the maximum bearing surfaces should be provided, particularly where the development of slack is seriously detrimental to the proper functioning of the parts or is hard to eliminate, as in draft gear connections and friction draft gears. It would be difficult to use so much material, properly distributed around the draft gear connecting parts, that any of it need be considered as wasted material.

(4) Try throughout the structure to so select the number, size and location of rivets as to balance the shearing, bearing and tensile stresses, on the basis of the well established ratios. So place all rivets that they will do the maximum work. Always keep in mind where the failure preferably should occur from the standpoint of maintenance.

FIRST COST AND COST OF OPERATION.

Above all else the car must hold its shape and the parts stay together if it is to give service. All of these points must be considered in the interest of strength, and with a view to reducing maintenance, which means keeping the car in service. But these are not the only considerations. The weight of the car is of great importance and keeping down the weight means not only reduced first cost but a reduction in the cost of operation continuing throughout the life of the car. The writer has in mind two cars designed for the same class of service under the same conditions, one of them the result of continued study through several stages of development, each represented by a complete design, the work covering a period of several years. The result is that the car finally developed represents a reduction in weight of 20 per cent when compared with the first car, 13 per cent when compared with the second design and 10.4 per cent when the third design is considered. This was accomplished without reducing the service value of the car from any standpoint; as a matter of fact, a considerably stronger car has been produced, and it is much simpler in construction.

The revenue load of the first car was 75.3 per cent of the total loaded weight and of the fourth car 77.35 per cent on the cubic capacity basis. With the lading increased in the fourth car to give the same wheel loads as the first, the revenue load was 77.95 per cent of the loaded weight. The

last design effects a direct reduction in first cost of over 10 per cent, and a saving in the cost of operation during the life of the car (assumed as 20 years) of at least one and one-half times the whole cost of the cars, because of the reduced dead weight to be hauled. In addition to this, it offers an opportunity to carry an increased load, due to its lighter weight, which means a very material increase in revenue on every car. In the fourth car, as compared with the best of the other three, there were about 25 per cent less rivets to drive.

The following suggestions are worthy of consideration in reducing the weight, and thereby the cost, without detriment to the service or strength of the structure:

(1) Eliminate as far as possible the lapping of material in joints. Extra material is often used in this way which does not enter into the calculation of strength and which often adds nothing to the strength of the structure. The designer, in an attempt to accomplish this end, is justified in having special shapes rolled when there are a large number of cars to be built, but should study carefully every available merchant shape before resorting to this expedient.

(2) When considering the use of any section, compare it and every other available section to see which gives the required strength with the minimum amount of material. Sometimes the form that appears as most suitable and gives the best finish is the least efficient in strength and weight of material. A freight car is primarily an article of utility, not one of beauty.

(3) See that there are no overhanging ends or corners which are simply extensions of serviceable parts, in themselves, adding nothing to the strength of the car or to its holding capacity.

(4) Reduce the end distance beyond the outside rivet holes on every piece, to the minimum consistent with mill and shop practice. Long end distances on many pieces total up to a large tonnage and frequently require re-shearing.

(5) Consider carefully what allowances should be made for corrosion in metal cars in order to provide against a decrease in strength to keep the car in service for a reasonable lifetime. Remember that where parts can be replaced without too much expense it is cheaper to replace them at intervals than to carry too much dead weight throughout the life of the car and pay interest on the extra investment in first cost for a long term of years.

(6) Consider every part from the viewpoint of repairs in case of wreck damage, taking into account the facilities at hand for producing a new part or repairing the damage part. Where a road has a large number of cars of the same type the necessary facilities for such work can be afforded, but the car may sustain the damage when away from home, where the repairs will hold it out of service for a long time.

A HANDICAP OF THE DESIGNERS

Very frequently the car designer finds himself handicapped by some things which he would like to change. What is now a standard has often become so because of its utility under conditions which no longer exist, or have been materially modified.

An outstanding example of this is the M. C. B. standard coupler with its standard length of shank and standard maximum height above the rail. The height of the coupler was fixed in the days of light wooden cars when the fact that the impact load falls out of line with the neutral axis of the sills was not of serious consequence. Conditions could be greatly improved now, however, if the coupler could be raised even two inches.

The length of the coupler shank was fixed without consideration of the possibilities of larger coupler heads, longer overhang of couplers, draft gears with long travels which

add so materially to their capacity, and without regard to the advantages in increased strength of fastenings if these were set further back on the car sills.

It is scarcely to be believed that it was ever the intention of the designer of the first automatic coupler, that the coupler, containing the movable parts of the locking mechanism, should receive the full shock of buffing blows. In the early days of the automatic coupler cars almost universally were equipped with dead blocks. Although later, when switchmen and trainmen were required to go between the cars to manipulate the coupler, the removal of the dead blocks may have been in the interest of safety, at the present time when there is no occasion for any one to go between the cars when coupling, the dead blocks might again be used to advantage. They would prevent the coupler, with its moving parts, and the draft gear from receiving greater blows than they can be designed to withstand. Under present conditions the coupler receives the full force of all buffing blows, an unreasonable service to which primarily may be due many of the break-in-tuos occurring to-day. By the use of dead blocks the force of all buffing shocks, above the capacity of the draft gear, could be delivered to the car structure directly in line with the neutral axis of the center sills or sufficiently above the neutral axis to counteract the effect of the coupler load, due to the distance of its line of action below that point.

These paragraphs have touched on only a small number of the problems of the designer and outline but a few of the limitations within which he must work. They may be suggestive, however, of the almost numberless leads for study in car design. Possibilities are always ahead of the diligent student if he can only free his mind from consideration of what has been done and start on fresh lines of thought. The real problem of car design, after all, is the selection of the best possible compromise when all the limitations imposed by existing standards or economic and engineering conditions have been clearly defined and carefully weighed.

HANDLING MATERIAL FOR THE CAR DEPARTMENT*

BY R. A. DOHERTY

Storekeeper, Delaware, Lackawanna & Western, E. Buffalo, N. Y.

The primary object of a railroad, as we all know, is to transport commodities of every description. In order to do this with safety and with the least expense, the equipment must at all times be kept in proper condition, otherwise considerable revenue may be lost, due to the railroad not being able to handle the business on account of poor equipment, and additional expense will be incurred as transfer-loads after shipments have once been made may be necessary.

It is the duty of the car department to see that the proper repairs to cars are taken care of as quickly as possible and with the least expense, while it is the duty of the stores department to endeavor to be able at all times to furnish the material required. In the first place it should be the business of the storekeeper and his force to see that a proper stock of standard materials is on hand at all times; this should be taken care of by following up each day the condition of the stock and reporting such items as are running low, or which may be entirely out. In cases where the material is being hurried and is made in one of the company's own shops, the storekeeper at that point should be urged for prompt delivery. In this way by constantly following up the stock you will be able, as a rule, to take care of the needs of the repair department.

In ordering the materials, uncertain deliveries must be

* Abstract of a paper presented at the Niagara Frontier Car Men's Association.

taken into consideration as well as the monthly consumption of all items. It is getting to be a very difficult matter nowadays to follow up the question of deliveries on a great many items, and, due to this fact, it is necessary at times to order in heavy quantities, otherwise your orders will not receive the desired attention. The above applies principally to standard items of material. Whenever special items are required, which, as a rule, are not carried in stock, the car department should immediately notify the storekeeper just what materials are wanted, and when the cars they are wanted for are required to be put into service, so that a special effort may be made to obtain such items promptly. This is a very important feature and if it is given the proper attention by the supervising foremen it will often avoid cars being held out of service unnecessarily.

Co-operation between the car and stores department employees is very necessary. The railroad company in general benefits in the end if each individual employee will forget to draw the departmental line and realize that all departments will show the proper results at the end of each year if the principle of co-operation between departments is followed out in a consistent manner.

In order to minimize the expense of handling, material should be stored as closely as possible to the shops and repair yards, where it is intended to be used. All valuable material should, without question, be stored under cover, and in addition under lock and key. Employees in charge of the material should be thoroughly familiar with it, so as to avoid delays in delivery. All heavy materials, such as wheels, couplers, etc., should be stored outside at the most convenient points, where the work is done on them by the shops. It is just as important to carry the stock of new freight car wheels close to the mill building where they are bored and mounted and the freight car couplers close to the blacksmith shop in order to have pockets applied, as it is to carry the balance of the stock close to the repair yard.

The stock of lumber required should also be carried as close as possible to the shops in order to save expense in handling. The finished lumber should be kept under cover adjacent to the repair yards, if possible, while the rough lumber should be kept close to the mill building. All material should be stored as close as possible to the points where it is intended to be used and not stored as a matter of convenience to the stores department, taking into consideration, of course, facilities for handling and storing material.

A very important feature in connection with this subject is the use of reclaimed material. It should be used instead of new material in every case where it is possible to do so. This point cannot be impressed any too strongly on your employees. By making use of reclaimed, instead of new material, thousands of dollars can be saved annually. A great many employees have gotten the idea that once a casting or a bolt is removed from a car it cannot be used again. It is a well-known fact that a great many of such items which are daily removed from cars being repaired are just as good as new, or can be made as good as new with little expense, instead of being consigned to the scrap.

It should be the object of the car department of every railroad to see to it that responsible men who understand material thoroughly have supervision over what is known as material gangs, which gather up all material removed from cars. Such material should be examined thoroughly at that time and any items which can be used to advantage should be placed in the reclaimed stock and the balance delivered to the scrap docks. This is the time when it will pay to have the material examined and not wait until it has been delivered to the scrap docks, as it may mean a big saving to the company to have such material available for immediate use.

Due to the unprecedented advance in the cost of materials, particularly during the last three years, railroads today are

facing a very serious and expensive situation in keeping the equipment in proper repair, and as I have just mentioned, it is the duty of every employee, regardless of department, to see that no new material is used where reclaimed material can be used instead.

Where shops have the facilities, it is now the practice to repair bolsters, couplers, axles, knuckles, etc., which were formerly scrapped. All bolts should be carefully sorted from the scrap, straightened, cut to the desired lengths, and re-threaded. All nuts can be assorted as to sizes and re-tapped, likewise all wrought iron washers can be reclaimed and assorted as to sizes. In fact, on every class of material handled, you will find a good portion of it can be reclaimed and made fit for use, instead of being sold for scrap.

There are two good points about this feature which it would pay us to remember; one is that a considerable saving is being effected in the use of reclaimed material and the other is that prompt repairs are being made to the cars by reason of using such material, whereas such work might be delayed considerably if sufficient new material was not on hand at the time. This reclaimed material question should be gone into thoroughly with the local inspectors at the outside inspection points, as well as foremen in the repair yards, as it is just as important to have this feature handled properly at these points as it is in the larger shops.

Our people handle this question in the following manner. All material required by local inspectors is ordered on our regular requisition forms once a month. These requisitions are forwarded to our general foreman, who turns them over to a competent material man, who in turn goes over each individual item very carefully and in every case possible, material from reclaimed stock is furnished before the requisitions are forwarded to the stores department for handling. I can assure you a good many dollars have been saved by this plan.

The accounting of material used is another important item which should be very carefully considered. The Interstate Commerce Commission Rules governing the classifying and accounting of materials cover this question thoroughly. In every large shop and repair yard the different foremen or clerks who have jurisdiction over the issuance of material tickets should endeavor to familiarize themselves with the standard rules of material accounting in order to see to it that all materials used are charged properly. This matter should be given very careful attention as the railroads are held strictly accountable for the proper distribution of material.

In closing, I would like to bring out two points very forcibly—the use of reclaimed materials and the co-operation of all employees to the end that all work required be done as promptly and as economically as possible. Each department head should instill in his subordinates the spirit of co-operation, and there is no question but that the railroad companies in general will greatly benefit in the end if this practice can be followed.

RAILWAY SHOP EMPLOYEES' PART IN THE WAR.—The Railroads' War Board has had prepared and distributed 50,000 copies of a colored poster, the first of a series, addressed to railroad men, which will be placed in shops and other places where railway employees gather. The poster is illustrated with a large locomotive and train and an insert showing soldiers firing a large gun. The wording is as follows:

YOUR NATION'S NEEDS AND YOUR PART IN IT.
 YOUR JOB DURING THE WAR IS TO CARRY THINGS WHERE
 THE COUNTRY NEEDS THEM.
 WHAT GOOD IS A GUN, UNLESS YOU HAVE IT WHERE IT
 IS NEEDED? WHAT GOOD IS A GUN WITHOUT SHELLS—
 WITHOUT FOOD FOR THE MEN WHO FIRE IT?
 YOUR SERVICES ARE ABSOLUTELY VITAL TO OUR COUN-
 TRY'S SUCCESS IN WAR.
 YOU ARE A RAILROAD MAN.
 THE NATION IS COUNTING ON YOU.



FREIGHT CAR MAINTENANCE

BY LEWIS K. SULLCON*



STEADY progress in the efficient operation of large train units will be considerably governed by our ability to so provide and maintain old and new equipment that a reasonable margin of safety will obtain. The greatest problem today is the all-steel car and it will continue to remain so unless adequate facilities are provided to assure a proper program of shopping. It is simply a question of time until the greater part of a steel car must be replaced; renewals can only be economically and quickly carried out on a large scale for each car, for the reason that corrosion is more or less uniform throughout each section of the structure and one part cannot be disturbed without equally affecting the adjacent one. As steel cars advance towards the time of their periodical overhauling, many fail in service due to deterioration and care should be employed in selecting the worst cars in a series to be handled first, or it may be that prior to being taken into the shops, they can be used for company material, cinders or in the case of gondola cars, have solid wooden floors applied temporarily and assigned to lumber, cane, tie, brick or pipe loading.

Steel cars develop peculiar weaknesses, dependent considerably upon the service in which they are operated. It may be that side girders cause difficulty in buckling, which perhaps may be due to a weak center sill construction, or a light top chord or compression side girder member. Sometimes, but not often, side sills need reinforcement, or it may be that the end sills and draft members fail considerably. In any case it is generally conceded that replacement should be carried out in re-designed construction or such modification of the old that thoroughly good service in operation is assured. Hardly any expense less than \$200 per car should be disregarded, if it is known that such expenditure will result in keeping the car away from the repair track the greatest amount of time between rebuilding periods, which extends anywhere from seven to twelve years.

Car Repair Costs.—Merely quantitative statements tending to reflect items such as average car repair costs, mileage per day, etc., for definite periods of time are only useful in a general way and in order to obtain a true idea of the actual cost of operation, it is necessary to determine the attitude in which the management of any road consider additions and betterments for instance, or write off depreciation. Sometimes many legitimate charges to capital account are allowed to remain under the heading of operating expenses unless due consideration is allowed for all accounting features affecting repair costs to equipment.

As a matter of interest repair costs on 28 prominent roads representing a total mileage of 119,857 and owning 1,119,481 freight equipment cars revealed the fact that those lines spending the least amount of money obtained the least mileage from their cars. For instance, a road in the western classification territory spent \$27.19 per car per year ending

June 30, 1916, and the average mileage amounted to only 2,632 miles per car owned per year. On the other hand, another road in the same territory spent \$79.30 per car per year during the same period and obtained 11,865 miles per car per year, or 32.5 miles per car per day, as compared to 7.21 miles per car per day in the previous case. The same relation, only not so marked, is true of roads in the Northwestern section of the country; here we find one road spending slightly less than \$100 per car per year rendering a mileage of almost 13,000 miles per car owned per year; this as compared to an outlay of less than sixty dollars per car per year, but a mileage of only nine thousand on an adjacent line. The general tendency throughout the country can briefly be stated, that those roads spending the most on their equipment to keep it in good physical condition are able to realize a practical corresponding increase in mileage. The following gives the average cost of maintenance on 29 roads:

District.	Number of Roads Compared.	Total Cars Owned.	Average Mileage per Car Owned per Year.	Average Cost of Maintenance per Car per Year.
Pacific Coast	3	62,326	11,846	\$74.91
Western	8	150,739	9,092	72.32
Northwestern	5	254,298	9,977	69.29
Central & Southern.....	6	162,936	9,345	87.47
Eastern	7	552,761	10,971	71.93
	29	1,183,060	10,246*	\$75.18

* Equivalent to an average of 28 miles per car per day.

DRAFT GEAR

Unquestionably, no feature of car maintenance and construction has been so fully discussed as that surrounding the question of the draft gear and many hard problems are presented from the standpoint that a proper determination of the subject involves a compromise between theoretical and practical considerations,—neither can be neglected. Aside from any reference to a usual discussion, it might be interesting to devote attention along the lines that the average car itself, on account of being generally resilient, embodies a capacity for absorbing severe shocks, tentative analysis of which is given in the following broad examples and ought to be considered in the sense of practical rather than mere theoretical reasoning, as one familiar with switching movements in large terminal yards, often wonders why more damage does not result from rough handling than is actually experienced.

This necessitates a consideration of the mechanical factors involved, that is, what are the stresses set up and what energy is involved in the movement of cars approaching each other as in yard service or in train service, wherein the cars are coupled together? The following calculations are basic in their nature and in accordance with well known laws. For the purpose of illustrating, mathematically, the amount of energy which must be transmitted through the draft gear and car framing, we have fixed upon a maximum coupling velocity of 6 m. p. h., with a view of approaching what might

* Mechanical Engineer, Illinois Central.

be termed violent yard service. The equipment taken into consideration in these calculations are gondola cars and furniture cars.

The energy which must be transmitted through the draft gear in a moving car striking another standing car of same weight and capacity (this condition is selected as being the least destructive of any combination which might be considered), equals one-half the mass multiplied by the square of the velocity. This figure should be divided by 4 to obtain the value of the work which should be absorbed or dissipated through the draft gear and other resilient parts of the car, in view of the conditions laid down above. The application of the figures above mentioned develop the following results:

Empty Gondola Car.—

Conditions:

Light weight of car.....	41,000 lb.
Capacity of car.....	110,000 lb.
Velocity of moving car.....	6 m. p. h.

First, the energy (E) developed in the cars at the time they come in contact must be determined. As explained above this is equal to one-half the mass (M) multiplied by the square of the velocity (V). This figure should be divided by 4 to

*Loaded Gondola Car.—*The same procedure is followed in this case as before except the weight considered is 151,000 lb. instead of 41,000 lb. The energy (E), therefore, is—

$$E = \frac{M V^2}{4} = \frac{4,689 \times 77.44}{4} = 45,394 \text{ ft. lb.}$$

Since the sills are capable of absorbing 14,763 ft. lb., the remainder 45,394—14,763=30,631 ft. lb., must be transmitted or absorbed by other members of the car than the sill—preferably of course by the draft gear.

Furniture Car.—

Conditions:

Light weight of car.....	45,000 lb.
Capacity of car.....	88,000 lb.
Velocity of moving car.....	6 m. p. h.
Area of sills (A).....	34.5 sq. in.
Modulus of elasticity (E).....	29,000,000
Elastic limit of steel.....	30,000 lb. per sq. in.
Truck centers (C).....	37.2 in.

By following the same procedure as outlined above the energy developed by the light furniture car is 13,532 ft. lb.

The amount of energy the sills may absorb without exceeding their elastic limit is 16,388 ft. lb.

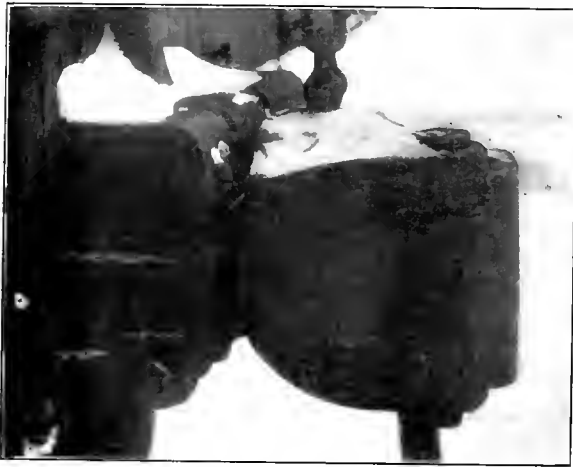

View No. 1.—Showing the car with the coupler pushed back towards the striking car.



View No. 2.—Showing the same car with the coupler pried out, denoting excessive slack which results from neglected maintenance.

An Example of a Poorly Maintained Draft Gear.

obtain the value of the energy which should be absorbed or dissipated in view of the conditions given above.

$$M = \frac{41,000}{32.2} = 1,272.67$$

$$V = \frac{6 \times 5,280}{60 \times 60} = 8.8 \text{ ft. per sec.}$$

$$E = \frac{M V^2}{4} = 12,317 \text{ ft. lb.}$$

The next step is to determine the amount of energy the sills are able to absorb (the cushioning effect) without being stressed beyond their elastic limit.

Conditions:

Area of sills (A).....	34.5 sq. in.
Modulus of elasticity (E).....	29,000,000
Elastic limit (L).....	30,000 lb. per sq. in.
Truck centers (C).....	37.2 in.

The elastic factor (e) of the sills is—

$$e = \frac{L \times C}{E} = \frac{30,000 \times 37.2}{29,000,000} = 0.38$$

The amount of energy these sills may absorb without exceeding their elastic limit is—

$$\frac{A \times L}{e} = \frac{34.5 \times 30,000}{0.38} = 177,156 \text{ in. lb., or}$$

$$\frac{177,156}{12} = 14,763 \text{ ft. lb.}$$

The amount of energy developed by the furniture car loaded to its capacity is 39,983 ft. lb.

The following table sums up all four cases and shows in addition the energy developed at 5 and 7 m. p. h.

Type of Car.	Conditions.	Weight in Lbs.	Energy in ft. lbs. to be Dissipated.		
			5 Miles per Hr.	6 Miles per Hr.	7 Miles per Hr.
Gondola.....	Empty	41,000	8,575	12,317	16,769
Gondola.....	Loaded	151,000	31,600	45,394	61,800
Furniture.....	Empty	45,000	9,421	13,533	18,424
Furniture.....	Loaded	133,000	27,833	39,983	54,434

In this connection it is well to state that these loads are not capacities or stresses, but simply energy expressed in terms of "foot-pounds," which is force multiplied by distance, that is, one foot-pound would be the energy developed by one pound passing through one foot of space, or two pounds through half a foot (6"), or four pounds through one-quarter of a foot (3").

Maintenance.—There seems to be a uniform misunderstanding regarding the maintenance of high capacity draft gears in general. When it is considered that we have a unit which is crowded into a very small space and designed to absorb in so far as possible the very worst shocks which service conditions impose upon it, any thinking person will appreciate that a certain amount of deterioration must re-

sult. With this thought as a foundation, is it not logical to assume that a penalty should be imposed upon the road which for any reason whatsoever offers a car in interchange with draft gears which have developed excessive lost motion; yet these conditions are experienced every day and result in break-in-tuos on account of air brake hose parting or draft attachments failing on account of excessive slack action. It is simply a matter of deferred or neglected maintenance and if we are to obtain reasonable protection to equipment through the medium of a high capacity draft unit, we must be prepared to stand the expense for the work fulfilled. There is no use going about this important matter in a disinterested manner.

Draw Bar Yokes.—The matter of determining between the use of cast steel or wrought iron drawbar yokes is largely dependent upon the viewpoint taken. From actual tests covering a large number of samples, selected at random, it may be stated that the maximum holding power of a new genuine wrought iron yoke carefully gibbed and fitted over the butt of the coupler and secured in place by two 1½ in. steel rivets, does not exceed 300,000 lb., the average being approximately 270,000 lb. On the other hand some roads require cast steel yokes to test out at 450,000 lb. when new and if under these conditions the construction employs the use of a gibbed design of pattern tending to relieve the coupler key from excessive strain, the full holding power of the yoke may probably be utilized in service with an ample factor of safety. The cross section, namely 5 in. by 1½ in. thick (5.64 sq. in.) of the M. C. B. standard coupler key,



Failure Caused by Poor Loading.

Damage caused by a load of dressed timber loaded in an adjoining car and which was not bulkheaded.

makes it necessary to provide a material of high elastic limit, not less than 0.40 per cent. carbon steel, in order to resist excessive bending in service and, furthermore, coupler keys wear considerably in the slotted openings through the sills, unless carefully maintained. The wrought iron yoke, if properly applied, will generally give satisfaction, but so many cases of neglect in this respect has to a large extent discouraged its use in certain sections of the country. Improper design or installation of any type of a drawbar yoke is poor economy and dangerous in practice.

REINFORCEMENT OF HOUSE CARS

Sufficient emphasis does not seem to have been laid on the need of suitable end reinforcement for house cars. Only a small percentage of the roads are really providing designs which meet present-day requirements, either from the fact that they do not care that foreign roads are continually obliged to replace the original construction through combination, or because they have failed to compile figures showing the costs of repeated replacement of light construction, of a car with no reinforcement other than the common unreasonable delay to equipment and loss of lading resulting therefrom. The difference between the strength of the ends of a car with no reinforcement other than the common wooden end post with heavy end lining and one with the

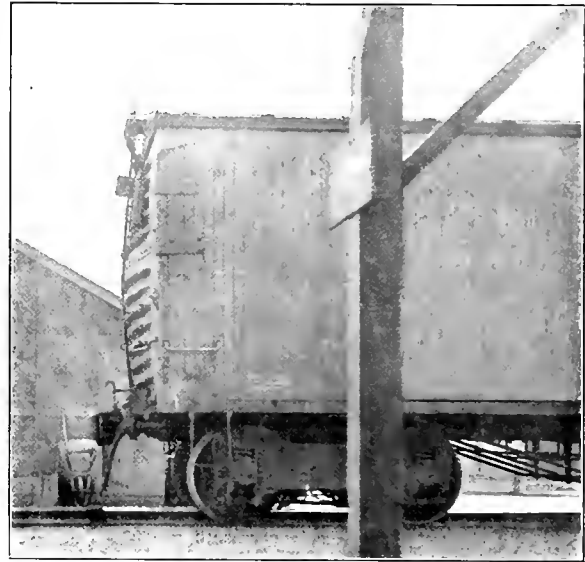

Substantial End Saves Damage Claims.

This car was loaded with power house machinery and had not a substantial end reinforcement been provided, a damage claim of large proportions might have been experienced, certainly more than the expense of providing the steel end to the car.

same construction supplemented by two rolled steel Z-bars properly tied in place has been shown by actual test to be practically 100 per cent. This was obtained with an addition of only 500 lb. of metal per car.

TRUCKS

No car, if allowed to operate a sufficient length of time, will fail to develop patent defects in the truck side frames and bolsters. A truck frame or bolster which fails to give seven years' service, can be classed as being improperly designed. There is no real economy in reducing the weight of these parts to such an extent that their service life is directly affected. Just to maintain a so-called standard, it is hardly desirable to replace broken parts on obsolete types of trucks; it is a simple matter to provide the latest design and remove the old style, employing all the useful material in the maintenance for other trucks of like construction. From actual observance of results obtained in service, it is a question whether, in the interest of safety, it is a far-sighted policy to weld broken truck side frames and bolsters, as some of this work seems to be poorly done by those employing the practice and has resulted in very serious accidents.

BRAKE BEAMS

Another important feature that should be given careful attention concerns defective brake beams and parts. Pos-

sibly the largest percentage of the difficulty lies in the brake head, the brake hanger and the brake shoes. A great many cars are now in service with parts worn to such an extent that they are absolutely unsafe. Some roads give the attention required by these items, while others seem to disregard them entirely. Brake beams should be raised to properly inspect the heads, hangers and keys while the cars pass over repair tracks. A properly applied truck brake arrangement should guarantee uniform shoe wear, full release of the shoes when the brakes are not applied and the elimination of torsional strains tending to collapse the trussed type of brake beams.

AIR HOSE

Those roads operating through extremely cold climates give serious consideration to the matter of inspecting cars for serviceable and safe (non-porous) air brake hose. This element of caution could well be applied throughout the country and the number of break-in-tuos, caused by bursted hose which generally result in disaster to car equipment, would be greatly reduced. For a single car or cut of cars with hose coupled together, it is only necessary to charge them with air in the usual manner, applying a standard coupling with the nipple end plugged to both ends of the car or cut of cars and open all angle cocks, then paint the hose with soap suds and remove any which show signs of porosity. If this practise were followed on all cars which are shopped or appear on the repair tracks, it would not be found to be a severe inconvenience.

A consideration of this matter would not be complete

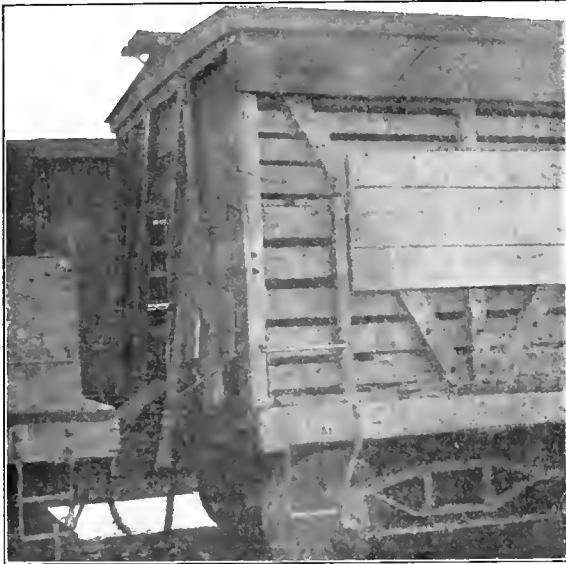

Weak Ends in Stock Cars.

Where stock cars are used for lumber loading, it is generally agreed that the posts should be securely braced, on account of the construction not admitting the application of heavy end lining such as is applied to other house cars.

without deciding upon the probable life of air brake hose made in accordance with M. C. B. specifications and applied to equipment operating under normal weather conditions. Data carefully compiled along these lines, covering hundreds of samples selected at random as manufactured by four of the leading rubber companies for four prominent roads discloses the fact that the maximum life obtainable for any of the samples selected did not exceed 50 months' actual service, the minimum being about 24 months and the average less than 33 months, representing a service mileage of 409,860 miles per hose.

RECLAMATION OF MATERIAL

To properly consider the reclaiming of material to be re-worked at a definite and known saving, would require too much detailed analysis and each branch of the work might be profitably considered separately; however, it is seldom that such items are dealt with satisfactorily in writing, as so much more can be gained from actual observation. Occasion is taken, however, to casually suggest a few of the items numbered among those generally followed throughout many sections of the country:

Re-rolling old truss rods into brake masts, column bolts, sill steps, flat bar iron for miscellaneous forgings.

Using arch-bar truck bottom tie straps to make brake

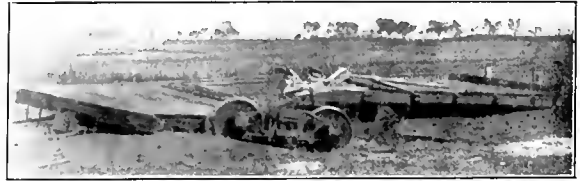

Wooden Flat Cars Should Be Eliminated.

The wooden flat car for main line traffic is fast proving a failure and is frequently the cause of serious accidents in terminals, as well as damaging first class equipment adjoining it.

beam safety supports, brake mast stirrups, reservoir supports, draft sill ties and old arch-bars to make coupler carrier irons, coupler horn braces for steel under-frames, side bearings and air brake levers.

Old bolts can be straightened and pieced out to advantage under a Bradley hammer.

Worn brasses can be re-bored and lined, also bearing wedges and journal boxes can be reclaimed by building up the worn places by means of the welding torch.

Many cylinder packing leathers removed from service can be re-treated. That is, after all the dirt and other foreign matter is removed, they are re-filled and made non-porous in large quantities at reasonable cost.

Journal truing and wheel grinding machines of proper pattern are elements tending to guarantee extensive savings under certain conditions.

Door hasps for box and stock cars, pressed door handles, etc., can be made from good parts of old plates removed from steel cars.

Old tubes can be pounded out and made into split keys, washers, etc.

With the increased difficulty in obtaining suitable lumber, it is natural to consider the utilization, in so far as it can be economically done, of dismantled material. Old car-lines and posts can be used as side door braces, old flooring, and for grain door nailing strips. Sheathing, if carefully removed, can be applied to work equipment and can be used for doors and as a lower course of roofing and lining in bunk and non-revenue cars. Short lengths of sills can be made into running board saddles, grain strips and cripples, and good parts of broken sills and serviceable sills from dismantled cars can be made into sill splices, if they are of the proper cross section.

Where fruit cars are required, it is generally economical to convert old equipment for this service.

In order to simplify the maintenance of a suitable stock of lumber on hand at all times, it is good practice to furnish a list of sizes covering the entire requirements for the system, a sample of which is shown below:

STANDARD SIZES OF CAR LUMBER—FREIGHT CARS. End Sills

White oak, 7½ in. by 8¼ in. by 10 ft.—caboose cars.
White oak, 7½ in. by 9¼ in. by 9 ft. 6 in.—30-ton fruit and caboose cars.
White oak, 7½ in. by 14¼ in. by 10 ft.—40 and 50 ft., 30-ton furniture cars.
White oak, 8¼ in. by 9¼ in. by 9 ft. 6 in.—40-ton box cars.

White oak, 8¼ in. by 12¼ in. by 10 ft.—40-ton gondolas and 40-ton flat cars.
 White oak, 8½ in. by 13¼ in. by 10 ft.—40 and 50-ton H. & B. side dump cars and 40-ton gondolas.
 White oak, 9¼ in. by 13¼ in. by 10 ft.—40 and 50-ton Rodgers ballast cars.

These are, of course, in addition to the usual material specifications which include the standard contour for all classes of lumber.

PAINTING

With a view towards the systematic maintenance of freight equipment, several roads have adopted rigid instructions regarding the periodical painting of cars which has resulted in great benefit to all-steel equipment and metal roofs on house cars. Below is shown an extract from existing instructions employed by one of the largest roads:

"The following figures are given as a general guide in

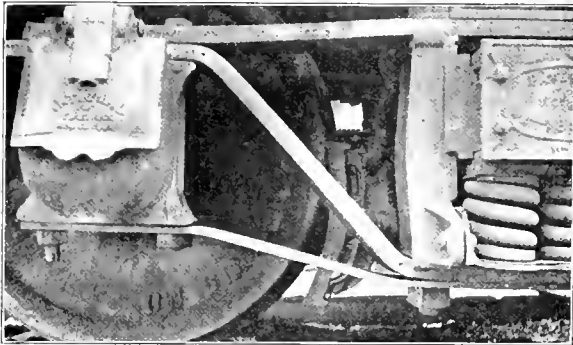

Poorly Designed Truck Side Frame.

Deterioration of spring plank channels provides a substantial argument favoring the use of strong sections and not mere pressings of the lightest thin plate.

arriving at a plan of carrying on the painting of cars in order to cover the entire ground periodically.

Kind of Car.	Cars Owned and Leased.		Average Re-painting per		
	All-Steel.	Wooden Box, etc.	5 Years.	Year.	Ratio.
House		28,595	5,719	475	.42%
Gondola	11,582	13,751	5,066	422	.39
Refrigerator		4,606	921	77	.07
Flat		2,994	599	50	.04
Stock (owned)		1,230	246	21	.02
Stock (leased)		371	74	6	.006
Caboose		797	155	13	.01
Tank	10		2		.004
Work		2,852	570	50	.04

"This indicates that, based on a life of five years for each re-painting period, we would have to re-paint 1,114 cars per month. Out of every 10 cars re-painted, the ratio should be 5 house to 4 gondola to one of all other classes of cars."

Cars are stenciled when painted, in a suitable manner, showing the date painted and the shop at which the work was done.

GENERAL

It is good business to repair cars and put them in serviceable condition when they are idle, having them ready for use when required, instead of having them held out or in service in a crippled condition. Good serviceable cars mean so much in reducing other expenses that there seems no reason why they should not be maintained in an efficient condition. A load placed in a defective car often means delayed movement, added expense in transportation, claims for demurrage and possibly dissatisfied patrons.

Undoubtedly the most economical repair costs may be obtained by the adherence to a policy of operating shops uniformly throughout the year, insuring the maximum yearly output with the minimum capital invested in buildings and

equipment, permitting the retention of a steady trained force of workmen and insuring the best condition of rolling stock at all times.

The men who hold supervisory positions in the mechanical department are without exception loaded with a burden of cares and responsibility which leaves them little time for the study of long, intricate statements or reports. Columns of figures, no matter how skillfully arranged, give the salient facts only upon diligent study. This should encourage particular care being exercised in the preparation of periodical reports, cost statements and results of tests.

Wreck Reports.—A careful analysis of wreck reports is well worth the time spent. The following was developed from a twelve-month record of reports for one large road. The defects listed are exclusive of assigned responsibility for collisions, bad track, broken rails, improper loading, side swiping or rough handling, disregarding signals and they are shown in order of extent to which damage occurred: (1), axle failures; (2), truck side frame failures; (3), wheel failures; (4), draft gear giving away; (5), bursted piping and hose; (6), center plates and side bearings locked; (7), truck brake rigging down; (8), improper location of the side bearings; (9), loose wheels; (10), failures of the truck bolster.

Central Repair Points.—The general centralization of heavy car repair work at important terminals is by far of the greatest economy, provided adequate facilities are installed to handle the work with despatch. It is simply deplorable to observe the almost universal absence of suitable facilities to care for the maintenance of steel freight cars throughout the country, when with suitable arrangements cars could be passed through the shops in less than half the time it takes at present; this with a corresponding reduction in expense. Practically all car repair shops throughout the country are overburdened with repair work, because a much larger number of cars are in service and freight traffic has reached the highest point in the history of this country. There is a degree of efficiency necessary to keep a car reasonably safe

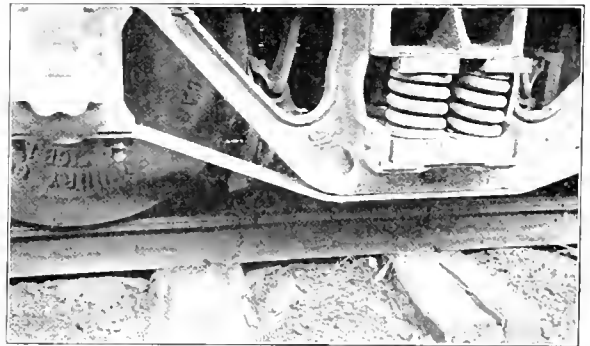

Improperly Hung Brakes.

A typical example showing the importance of providing a properly designed brake arrangement. It is also to be noted that all nuts and bolts should be properly locked from turning or becoming detached.

for handling, and for the protection of the freight it carries. This efficiency must be such as to prolong its life at minimum cost. Greater uniformity in construction would insure a larger output at less cost, as suitable material would be more readily available and workmen becoming familiar with similar construction could perform the work with greater despatch.

Stores Department.—There is often a tendency in the part of the mechanical department to feel a lack of responsibility in the matter of keeping the general storekeeper fully advised in advance as to the requirements of the mechanical

department and also as to any necessity in its assisting to avoid an excessive accumulation of stock. Shortage of material is unavoidable under present market conditions, no matter how large or varied a stock is carried, but much of this can be prevented by keeping the division and general storekeeper fully advised as to the progress of the work for

which material is needed. Every mechanical officer should consider it his duty to frequently make a thorough inspection of all material carried on hand for his department. As a rule the divisional mechanical officer who works in closest harmony with the division storekeeper is the one who least often is heard to complain about the shortage of material.



M. C. B. LETTER BALLOT RESULTS

No. 2 Brake Beam Adopted as Recommended Practice with Modifications ; Other Important Changes

At a meeting of the executive committee of the Master Car Builders' Association held in Chicago on June 14, 1917, a letter ballot containing 108 questions suggested by the various committees, was formulated to be submitted to the members of the Association. Of these 108 questions five were rejected by the members as follows: Specifications for journal box packing; the need for specifications covering freight car lubricants; the revision of section 41 in the specifications for lumber; the advancement of journal bearings for passenger and freight equipment to standards, and the revision of M. C. B. sheet U-11 regarding the pulleys, pulley seats and pulley keys for electric lighting equipment of passenger cars.

Following is an outline of the more important questions submitted to letter ballot which were accepted:

STANDARDS AND RECOMMENDED PRACTICE

It was voted to increase the over-all width of the bearings for 4 1/4-in. by 8-in. journals from 4 1/8 in. to 4 3/8 in., and on 5 1/2-in. by 10-in. journals from 5 1/4 in. to 5 3/8 in. in order to allow for the proper boring of the bearing, the present dimensions leaving too thin an edge after boring for a 5/16-in. lining metal.

The following items listed in the 1916 proceedings as recommended practices are advanced to standards:

- Specifications covering dimensions and tolerances for solid wrought steel wheels for freight and passenger car service.
- Minimum thickness for steel tires.
- Wheel tread and flange for steel and steel tired wheels.
- Wheel circumference measure for steel and steel tired wheels. (It was voted to have this measure cover steel, steel tired and cast wheels, thus eliminating the circumference measure for cast iron wheels shown on M. C. B. sheet 16.A.)
- Roundly gage for solid steel wheels.
- Flange gage for solid steel wheels.
- Lining for outside-framed cars.
- Sizes and dimensions for solid steel wheels. (It was also voted to change the name to wrought steel wheels.)
- Truck side bearing clearance.

Limiting Dimensions for Pedestal Jaws for Cast Steel Truck Sides.—It was voted to change the limiting dimensions *B* for the 70-ton truck frame which are given on M. C. B. sheet 8 to the following:

- Truck frame maximum 5 15/16 in., minimum 5 3/8 in.
- Journal box, maximum 6 1/16 in., minimum 6 in.

LOADING RULES

Rule 9.—Rule 9 has been changed to read: "Lading on single cars must never project over the end sill of the car unless such overhang is protected by an idler or carrying car forming part of a group of cars." See Fig. 1." Note.—Fig. 1 and the first sentence of rule 10 has been changed to conform with the rule.

Rule 12.—The principal change in this rule was in the second sentence; it now reads: "(B) Hemlock or similar wood may be used only for the following loads: For single loads of stored lumber, rules 32, 33 and 34 (Figs. 5 and 6);

for loading of tan bark, rules 60, 61, 62, 63 and 64 (Figs. 22 and 23); for loading of skab wood, rule 66; for lading of laths, rule 66a (Fig. 24) and for chocking and blocking for any load."

The paragraph *A* in the existing rule has been changed to paragraph *E* and now reads: "Gondola cars with sides 30 in. high and over may have the stakes placed on, inside of the car sides, either in or out of the pockets, providing the stakes rest on the car floor and are substantially wedged to the car sides by the lading."

Rule 13.—The sentence in the parenthesis in this rule has been changed to read as follows: "(Hemlock may only be used for single loads as provided for in rule 12, section B.)"

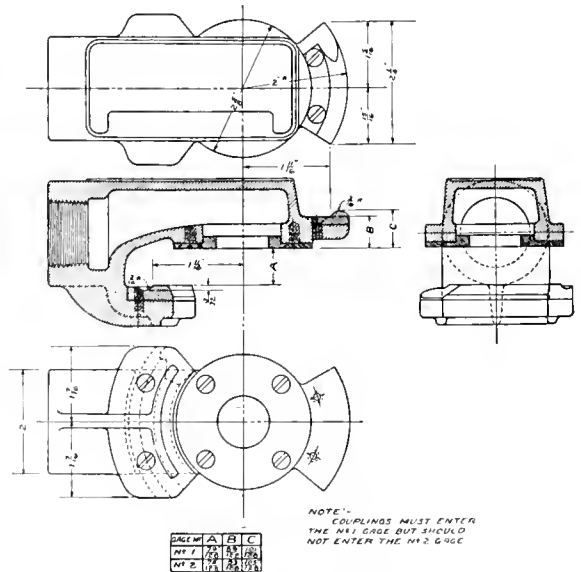

Fig. 1.—Gage for Air Brake Hose Couplings

Rule 33.—In the first line after the word "equal," change the word "width" to "thickness" and after the word "side," in the eighth line, add the following: "Provided that strips will not be required if load does not extend more than 30 in. above the top of car sides."

Rule 34.—Section *D* is changed to read as follows: "For loads of lumber lapped or stripped in accordance with rule 33, size of hardwood stakes must not be less than:"

Rule 36.—The reference in the parenthesis in this rule has been changed from rule 34 to rule 13.)

Rule 58.—The second paragraph of this rule has been changed to read as follows: "When lading is in two piles

on flat or gondola cars and the ends of poles are interlaid at the center of the car as per Figs. 18, 19, 20 and 21, there must be not less than three pairs of stakes per pile, or six pairs of stakes for the total length of load." Figs. 18, 19, 20 and 21 are revised to conform to these changes.

Rule 67.—A note has been added to this rule reading as follows: "Sawed ties of more than 12 ft. in length may be loaded on flat cars, subject to the rules governing the loading of lumber on open cars.

"Hewn ties more than 12 ft. in length may be loaded on flat cars, subject to the rules governing the loading of logs,

The K-1 triple valve for 8-in. and the K-2 triple valve for 10-in. air brake equipment were advanced to standards.

SPECIFICATIONS

The specifications for the following material were adopted as recommended practice: Black paint; elliptical springs; insulation paper for refrigerator cars.

The paragraph regarding "deflection test" was added to section 4 of the specifications for air brake hose gaskets. The specifications for helical springs were rewritten. A slight change was made in the specifications for steam heat hose for passenger equipment cars, steel axles, and air brake and train air signal hose.

The knuckle pivot pin specifications were eliminated, being substituted by the specifications for heat-treated knuckle pivot pins and these were advanced to standard. The requirement for silicon was omitted from these specifications.

A few changes were also made in the specifications for lumber, the most important of which was the addition of a note following section 42, as follows:

"Note.—For material furnished in accordance with sections 43 to 47, the following 'Density Rule' may be

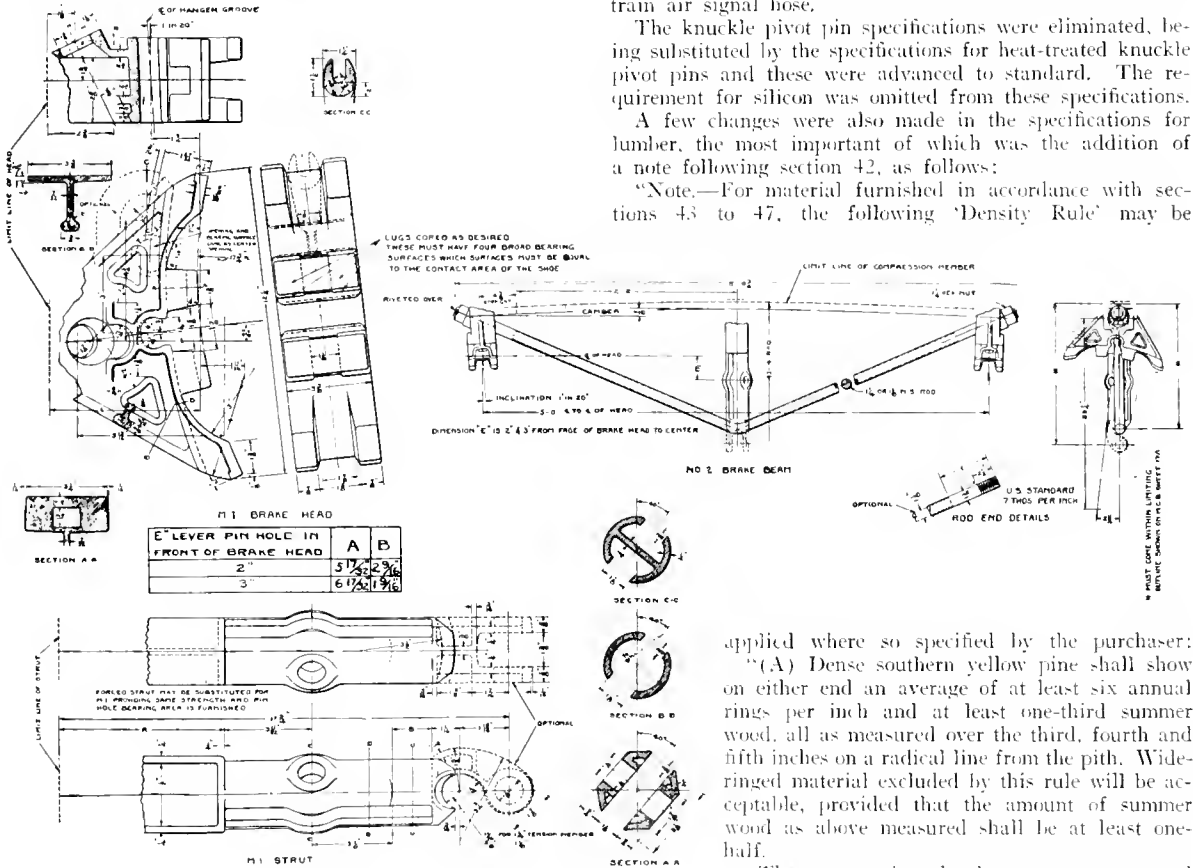

Fig. 2—No. 2 Brake Beam Adopted as Recommended Practice by the M. C. B. Association

pling, props, telegraph and telephone poles."

Rule 81-C.—In the third line change the size of the top clamp from 2 in. by 4 in. to 4 in. by 6 in.

Rule 93.—The following note has been added to this rule: "The metal sliding plate used in connection with twin or triple loads of flexible material should be greased at interchange points to facilitate the curving of the cars."

Rule 124.—A paragraph has been added to this rule as follows: "Lading in vehicle cars with end doors must be securely protected against end shifting and loaded in such a manner that the lading will not come in contact with the end or side doors."

TRAIN BRAKE AND SIGNAL EQUIPMENT

It was voted to change the rules covering the adjustment of piston travel to read as follows: "Piston travel should be adjusted to not less than 6 in. nor more than 8 in."

The gage for air brake hose couplings shown in Fig. 1 was adopted as recommended practice.

applied where so specified by the purchaser:

"(A) Dense southern yellow pine shall show on either end an average of at least six annual rings per inch and at least one-third summer wood, all as measured over the third, fourth and fifth inches on a radial line from the pith. Widering material excluded by this rule will be acceptable, provided that the amount of summer wood as above measured shall be at least one-half.

"The contrast in color between summer wood and spring wood shall be sharp and the summer wood shall be dark in color, except in pieces having considerably above the minimum requirement for summer wood.

"(B) Sound southern yellow pine shall include pieces of southern pine without any ring or summer-wood requirement."

The following specifications were advanced from recommended practice to standards:

- Carbon Steel Bars for Railway Springs.
- Rivet Steel in Rivets for Passenger and Freight Equipment Cars.
- Mild Steel Bars for Passenger and Freight Equipment Cars.
- Chains.
- Cement for Mounting Air Brake Hose.
- Galvanized Sheets for Passenger and Freight Equipment Cars.
- Structural Steel, Steel Plates and Steel Sheets for Passenger Equipment Cars.
- Structural Steel, Steel Plates and Steel Sheets for Freight Equipment Cars.
- Welded Pipe.

BRAKE BEAM AND BRAKE SHOE EQUIPMENT

It was voted to adopt as recommended practice a strut, strut lever and lever pin connection for brake beam and lever of 1 3/32 in. in diameter by 3 1/2 in. under the head; a brake

beam hanger pin of 1¼ in. in diameter by 7 in. under the head, and a brake beam hanger diameter of 1 in.

No. 2 Brake Beam.—The brake beam committee succeeded in designing a No. 2 brake beam which, with certain limitations, has been accepted by the association as recommended practice on a close vote, 1,425 voting in favor of it, 673 against it, with 1,399 votes necessary for adoption. This has been accepted with the understanding that a future report will be made on the compression member and its attachment to the head and strut members. The beam is shown with its details in Fig. 2. It is further understood that this beam is adopted only as a progress design, as the final requirements have not been worked out by the committee. No third point suspension is shown. It is optional in providing a 1½-in. opening at the end of the strut casting for supporting this portion of the beam by any means desired by any road, but that is not compulsory in the construction. A tabulation of the malleable brake heads which are being put on beams developed the fact that they weigh all the way from 6½ lb. to 21 lb. apiece. In the first case the shoe

thin and worn vertical flanges of cast steel wheels to 15/16 in. when worn thin and 1 in. when worn vertical, which is the same as for wrought steel wheels.

An additional paragraph was added under the heading "mounting wheels," in the specifications for 33-in. cast iron wheels, as follows: "The wheel face on all axles must be turned to a uniform diameter throughout the entire length of each wheel fit and must be smooth and free from ridges, so as to provide an even bearing for the wheel fit throughout.

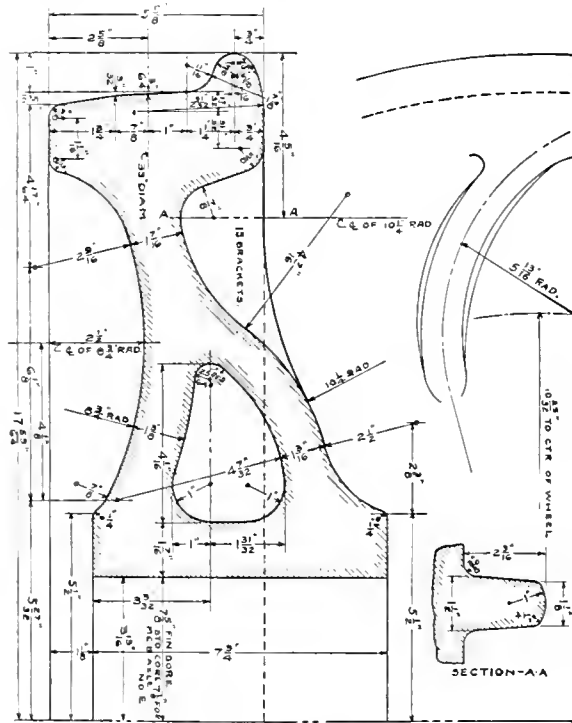

Fig. 3—Cast-Iron Wheel for Cars of Maximum Gross Weight Not to Exceed 210,000 lb.

cracks and works out, and in the second case an unnecessary amount of malleable iron is being purchased. In the design of the brake head, the pot-hook opening is shown at the center as the committee feels that the center hanging is correct. However, an optional location shown by dotted lines in Fig. 2 for the pot-hook opening at the upper end of the head is permitted.

The specifications and tests of brake beams were revised.

CAR WHEELS

The 33-in. cast iron wheel shown in Fig. 3 was adopted as recommended practice for cars of maximum gross weight not to exceed 210,000 lb.

The 33-in., 700-lb. cast iron wheel shown in Fig. 4 was adopted as recommended practice in place of the present 675-lb. wheel of the same diameter.

It was voted to change the condemning limits for worn

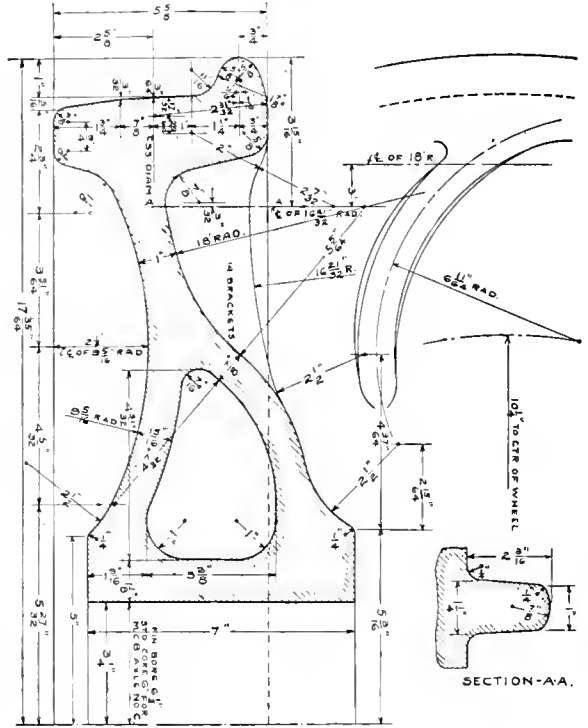

Fig. 4—Section of 700-lb., 33-in. Cast-Iron Wheel Adopted to Replace the 675-lb. Wheel.

Mounting wheels on axles having the wheel fit tapered is not permissible."

TRAIN LIGHTING AND EQUIPMENT

The following paragraphs of the specifications for electric lighting of passenger equipment cars were advanced from recommended practices to standards:

- Paragraph 1. (System voltages.)
- Paragraph 5. (Mounting.)
- Paragraph 6. (Axle pulley and bushings.)
- Paragraph 9. (Size of ball bearings.)
- Paragraph 10. (Boxes, design.)
- Paragraph 12. (Dimensions of battery trays.)
- Paragraph 13. (Connections.)
- Paragraph 14. (Charging receptacles.)
- Paragraph 16. (Terminals.)
- Paragraph 19. (Switchboards.)
- Paragraph 20. (Fuses.)
- Paragraph 21. (Installation of conduit and wire.)

TANK CARS

A number of changes were made in the specifications for tank cars, most of which are minor in character and as a rule do not change the substance of the present requirements. The following are the principal changes: Item 23 in the class I and class II specifications was changed to permit the restricted use of cars tested to 40 lb. after January 1, 1918.

In the specifications for the class III and the class IV tank cars item 9, paragraph 3 has been changed so that malleable iron for striking plates and draft lugs is optional.

A new set of specifications called "Class V, Tank Car" was adopted for the use of chlorine and sulphur dioxide.



Instructing an Apprentice in the Cabinet Shop.

FREIGHT CAR APPRENTICES ON THE SANTA FE

Difficulties Encountered in Securing Recruits and Successfully Training Them Gradually Being Overcome

THE Atchison, Topeka & Santa Fe has had exceptionally good results in its attempts to provide an adequate apprenticeship course for its freight car apprentices. That part of the proceedings of its ninth annual apprentice instructors' conference referring to this class of apprentices, an abstract of which follows, is therefore of more than ordinary interest. A similar account of the proceedings of the eighth annual conference was published in the *Railway Mechanical Engineer* of August, 1916, page 403. That the importance of making a decided effort to select and train young men for this work is becoming more generally recognized is indicated by the large competition on this subject which was held last year under the direction of the Chief Interchange Car Foremen's Association. The prize article was printed in the November, 1916, issue of the *Railway Mechanical Engineer*, page 579. The second prize was awarded to C. N. Swanson, superintendent car shops of the Santa Fe, Topeka, Kan. It was printed in the December, 1916, issue of the *Railway Mechanical Engineer*, page 639, and gives an excellent outline of the courses of training which are provided for car department apprentices on the Santa Fe. The more important parts brought out at the recent conference follow:

WHAT IS NEEDED IN THE FREIGHT CAR SHOP?

O. D. Buzzell, general foreman, car department, San Bernardino, Cal., spoke on this subject as follows:

In addition to teaching the boys carpenter work they should also be given a thorough training on airbrake equipment. The Interstate Commerce Commission requirements are very strict regarding the airbrake equipment. Furthermore, if these men are made familiar with air work, it will serve to retain more of them in service, as they will be able to command a better rate of pay, and be eligible for further advancement as inspectors. Our apprenticeship

system is the best method known for training men in air brake equipment.

The highest class of car work is given the apprentices at San Bernardino, including the reconstruction of cars. After a boy is far enough along the car carpenters are glad to have them work with them. Start the boys on truck work. As this is the foundation of the car, it should also be the foundation, or first work of the apprentices. During the course they should be given an opportunity to see how every part of a car is constructed.

Mr. Buzzell commented on the rapid change from the wood freight car to the steel car, and emphasized the importance of giving the apprentices a thorough training on steel work. As long as we have refrigerator cars there will always be more or less wood work, but the trend is toward the use of the steel car, and it is up to us to prepare for this need.

Discussion.—It is important that the instructors take an interest in the work of the boys and in the personal life of the boys, and they should be encouraged to save.

The latter point was emphasized by S. L. Bean, mechanical superintendent, who also mentioned the importance of helping to develop the young man's character, and doing all possible to keep him out of bad company.

The school hours of the boys of this trade were also discussed; it was the consensus of opinion that instead of having two hours of school twice a month, they should be allowed to attend school as often as apprentices of other trades, that is, two hours a week, if it is possible. The school should be held in the morning hours rather than in the afternoon.

INSPECTION WORK—HOW HANDLED.

In teaching the apprentices inspection, it was thought best to teach them the minor defects first, and later the com-

plex defects. When an apprentice is on any particular class of work, the principal or common defects arising therein should be explained. This should be carried out throughout the entire apprenticeship. The instructor should go with the boys and actually make an inspection trip over a train of cars. The boys should be taught to live up to the M. C. B. rules explicitly. It was agreed by all that the inspection work should be given the apprentices toward the last six-months' period of their course.

TEACHING M. C. B. RULES

In order that the apprentices may fully understand these rules, it is best to have the school instructor teach the boys the rules in the school room; this to be followed up by the work of the shop instructor. The shop instructor, wherever possible, should give the boys work on foreign cars, where they may have a better opportunity of explaining the rules to the apprentices.

The subject of teaching the apprentices the manner of billing for repairs on freight cars was also discussed. It was suggested that the local instructors arrange for the M. C. B. clerk, or travelling car clerk, to visit the school room occasionally and give instructions to the freight car carpenter apprentices regarding the bills to be made out incident to repairing foreign cars.

METHOD OF SECURING APPLICANTS

It was pointed out that applicants for this trade were very hard to secure, particularly so in some localities. The general opinion seemed to be that the best applicants had been secured from labor gangs in the shops or car yards, from sons of employees, or from friends of other apprentices. Many good boys have been obtained from nearby towns, and often have made application as a result of baseball games in these localities. It was suggested that when one of these boys from a nearby town went on a vacation the instructor should make it a point to speak to him about his work, and in wishing him a good time on his trip should suggest that if there were any other good boys in his home town who would care to serve an apprenticeship in the car shops, to have them make application. In this way, many good boys have been obtained. When a prospective applicant calls upon the shop instructor, the latter should make it a point to show him thoroughly what work the apprentices in this trade are given, and what the opportunities are for advancement.

In addition to the difficulty of securing good applicants for apprenticeship in this trade, still greater difficulty was reported in holding the young men during the first six months' period. The boys are older than the apprentices in other trades, most of them being 20 to 24 years of age. Since many of them are married, they have great difficulty in pulling through, with the wages being paid at present. It was agreed by all the instructors that if a higher rate of pay was given during this period it would be of material help in holding these boys.

It was urged, too, that a greater variety of work should be given the apprentices during the first six months to keep them interested in their work and let them know that they are actually learning a trade and would later receive greater benefits. It was urged also that the instructor enter thoroughly into the home life of the boys, and make them feel that he is their friend. In connection with the question of humane treatment and kindness that should be accorded the apprentices, the following poem was recited:

If with pleasure you are viewing any work a man is doing,
If he's worthy of the comment, tell him now.
Don't withhold your approbation till the parson makes
oration,
And he lies with snowy lilies o'er his brow;

For then, no matter how you shout it, he won't really care
about it.

He won't know how many teardrops you have shed—
If you think the praise is due him, now's the time to slip
it to him.

For he cannot read his tombstone when he's dead.

More than fame and more than money, is the comment kind
and sunny.

And the hearty warm approval of a friend;

For it gives to life a savor, and it makes you stronger,
braver.

And it gives him heart and spirit to the end.

If he earns your praise, bestow it; if you like him let him
know it.

Let the words of true encouragement be said.

Do not wait till life is over and he's underneath the clover,
For he cannot read his tombstone when he's dead.

SCHEDULE OF WORK

It is best to start the boy out on truck work, as far as possible, and have the inspection work given him last. In general, the schedule adopted at the last meeting (*Railway Mechanical Engineer*, August, 1916, page 404) has been found very satisfactory, though, of course, it will have to be varied according to the location.

INSTRUCTORS CO-OPERATE

The school instructor can assist the shop instructor in teaching M. C. B. rules; also in helping the boys on air work with the charts in the school room. From charts showing the anatomy of freight cars, flat cars, etc., he can give the apprentice much instruction that will assist the shop instructor in teaching the work of this trade. He can also assist in teaching safety appliances and should train the boys in sketching and drawing.

The freight car shop instructors introduced a resolution stating that they believed it would be a great benefit to both the shop instructors and the apprentices if they could have blue prints showing classes and series of freight cars, these to be filed in a convenient place for the use of the apprentices. They have experienced much trouble because of not having access to prints. Standard prints are just as essential in the car shop as in the locomotive shop, and a series of prints should be worked out and made available for the use of the apprentice boys.

UNIQUE UNDERFRAME REINFORCEMENT

For several years the Marsh Refrigerator Service Company, Milwaukee, Wis., has been building steel underframes which have been applied both to new cars and to old cars requiring reinforcement of the draft members. A new design has recently been adopted by this company which is of interest because of several novel features, the most important being the arrangement for making use of the bolsters removed from rebuilt cars in connection with the new underframe.

The underframe formerly used was built up of two 9 in. 20-lb. channels extending the entire distance between the end sills and reinforced in the center section by a 13 in. 32-lb. separator channel. The body bolsters were steel castings with cored holes through which the center sill channel passed. Heavy cast steel striking blocks were used. The center of the car was carried on needle beams of channel section, attached to the center sills and further supported by four truss rods.

In order to do away with the necessity of providing new body bolsters when reinforcing cars, the design of the underframe has been modified. The center sill cross

section has not been changed, but the channels, instead of extending the full length of the car, are brought only to the bolsters. Economy draft arms of special design, fitting over the bolsters and securely riveted to the center sill

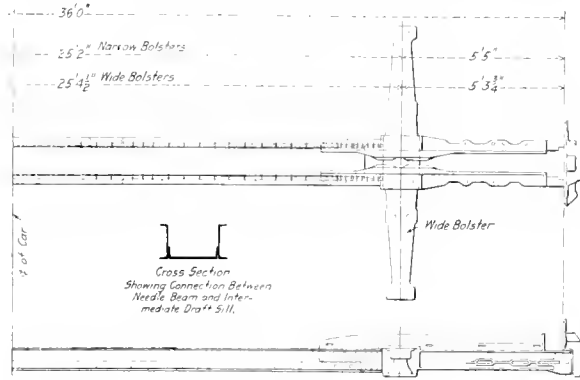

Half Section of the Underframe Used by the Marsh Refrigerator Service Company

channels, form the center members at both ends of the car. The draft arms are made to accommodate Farlow draft gear with 8 in. by 8 in. springs. Cast steel striking plates similar to those used on the original design are riveted to the draft arms; thus, the end sill is held securely between the lug on the draft arm and the striking casting. Two of the truss rods pass through the striking casting and over

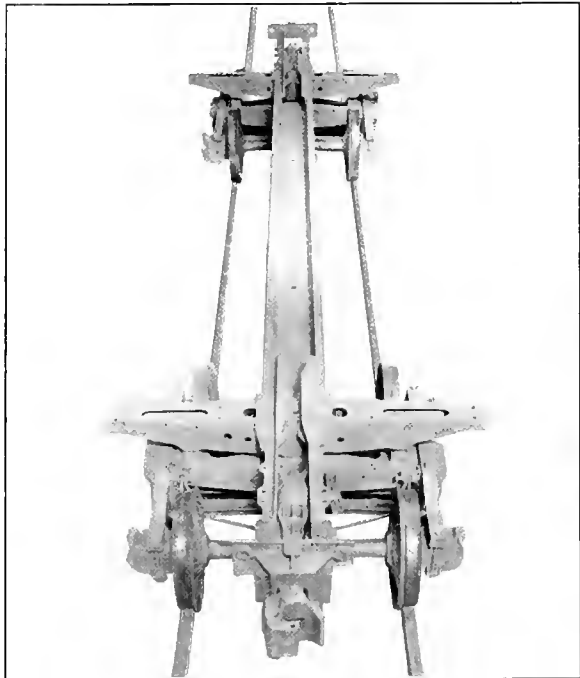

Underframe Ready for Application of Car Body

saddles at the bolsters, furnishing additional support for the outer ends of the draft arms. A change in the needle beam has also been made in this design. It was found that in case a car was knocked off center considerable damage was often done to the wooden sills by the metal needle beams. It was therefore considered best to return to the use of wood for these members.

In building wooden refrigerator cars to be used with steel underframes, the sizes of the wooden sills are not reduced. It has been found advantageous to have the car bodies sufficiently rigid to do away with the necessity of supporting them at a large number of points when they are raised off the underframe. In the present design side sills of 5 in. by 10 in. section have been used with 5 in. by 9 in. intermediate sills and 5 in. by 8 in. center sills.

In designing the new underframe it was desired to make it applicable to cars of two different series, one having a body bolster 14 in. wide while the bolsters on the other series were 11 1/2 in. wide. In order to accommodate both bolsters the underframe was designed with a 14 in. bolster

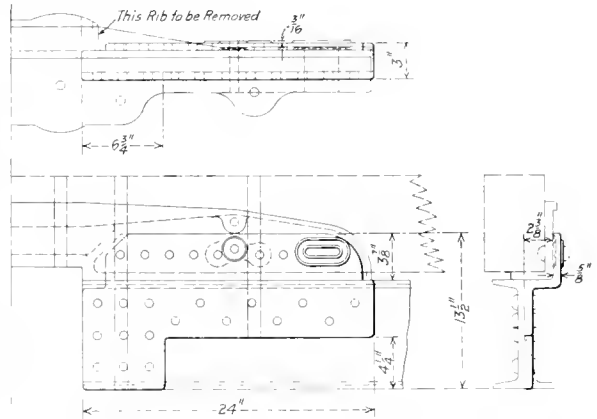

ADAPTER CASTING USED ON ECONOMY DRAFT ARM

opening. When applying underframes to cars with 11 1/2 in. bolsters a 2 1/2 in. filler casting is welded to the bolster. Some of the cars now being reinforced with steel underframes have been equipped with the Economy draft arm applied to the wooden sills. In order to save the draft arm a casting was designed to be attached to the section of the

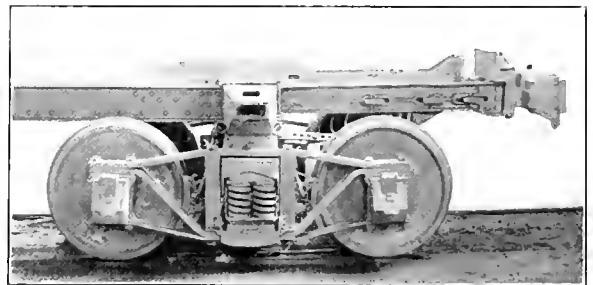

View Showing Construction at End of Underframe

draft arm which extends beyond the bolster, joining it with the center sills in the same manner as in the case where the special design of draft arm is used.

THE FIRST SUBMARINE.—The first submarine boat of which history makes any record was built by a Dutchman, named van Driemel, in 1640. The boat was built in England with money said to have been advanced by King James I. According to reports the vessel had a unique ballasting system. There was a number of goatskin bags placed under the deck between two large planks. These bags, when filled with water, caused the vessel to sink. To cause it to rise again the bags were pressed together again with a windlass arrangement, forcing the water out, and thus giving the boat reserve buoyancy.—*The Engineer.*

TANK CARS FOR THE SANTA FE

Constructed in Accordance with the Latest M. C. B.
Class III Specifications, of 12,000 Gal. Capacity

THE Santa Fe has ordered from the Pressed Steel Car Company, 500 tank cars of 12,000 gal. capacity, which are to be used largely in the company's service for handling fuel oil. These cars were designed by the railroad in accordance with M. C. B. specifications for class III tank cars as revised in 1916.

The barrel of the tank is of open hearth steel plate, the bottom being a continuous plate $\frac{1}{2}$ in. thick and 83 in. wide. The upper part of the barrel is in five sections of $\frac{3}{8}$ in. plate. The heads are $\frac{1}{2}$ in. thick and are dished to a radius of 10 ft. The dome is 5 ft. in diameter inside and is made of $\frac{5}{16}$ in. plate on the sides and $\frac{3}{8}$ in. on the top. The dome cover is dished to a radius of 8 ft. The dome ring

the upper plate placed 3 in. from the inside of the top of the tank shell and with a $5\frac{3}{8}$ in. space between the upper and lower plates. They are secured to the shell by $\frac{5}{16}$ in. gusset plates. The bottom outlet valve casing is of the usual type except that it has an internal thread above the valve seat into which a casting is fitted which serves as a valve rod guide and also prevents foreign substances from getting under the valve seat. The safety valves are two in number of the latest M. C. B. standard type attached to the top of the dome and set to open at a pressure of 25 lb. per sq. in.

An ingenious method of fastening has been used on the handholds at the ends of the tank. In order that the handholds may be replaced from the outside they are attached

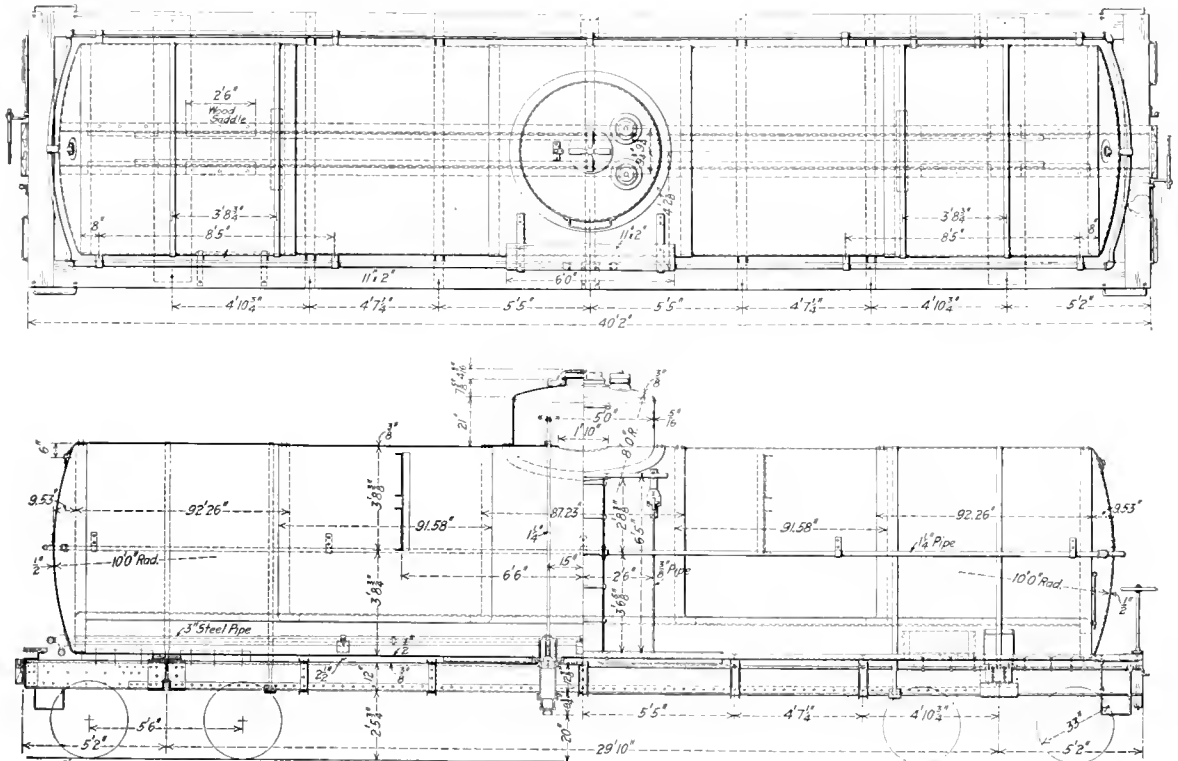

Santa Fe Tank Car Built in Accordance with the New M. C. B. Specifications

is of cast steel and the dome cover of malleable iron. The cover has the usual outlets just below the flange to allow any pressure confined in the tank to escape before the cover is removed. There is a special lead gasket provided on the lower side of the flange of the tank cover and four holes spaced at 90 deg. are cored in the top so that pipes may be inserted to facilitate the application and removal of the cover.

One of the unique features of the construction is the application of splash plates to prevent an unequal distribution of weight on the trucks during brake applications. Two of these splash plates are provided, one on each side of the center of the tank and 6 ft. 6 in. from the center. They consist of two sections of $\frac{5}{16}$ in. plate, each 18 in. wide,

with a special stud. The section is such that breakage is most apt to occur outside the hexagonal portion of the stud, in which case it can be readily removed with a wrench. In case the stud is broken flush with the tank it can be drilled out and replaced from the outside.

As the vapor given off by fuel oil is poisonous, the cars must be steamed out before it is safe for a workman to enter them to make repairs.

In one end of the tank near the top a 4-in. pipe flange and plug are provided to facilitate washing out the tank. The heater pipes are arranged according to the Vapor Car Heating Company's system. Two flanged couplings are provided at one end of the car. The main steampipes, 3 in. in diameter, are screwed into these castings and extend along the

bottom of the tank for nearly the entire length, being closed at the end with a pipe cap. Inside each of the 3-in. pipes is a 1-in. pipe held in position by star couplings. The end

channels. The body bolsters are of built-up construction with a cast steel center filler and $\frac{3}{8}$ in. pressed steel side diaphragms spaced 5 in. back to back and reinforced on top and bottom by $\frac{1}{2}$ in. steel plates 16 in. wide. On top of the bolsters are cradles built up of $\frac{5}{16}$ in. plate. Wooden blocks fitted into these cradles support the tank at each end.

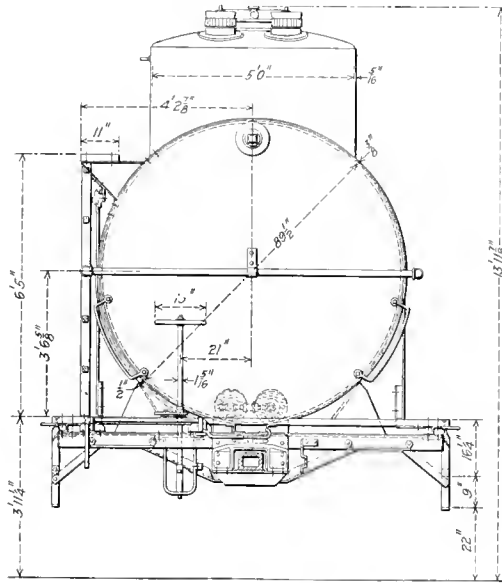

End View of the Santa Fe Tank Car.

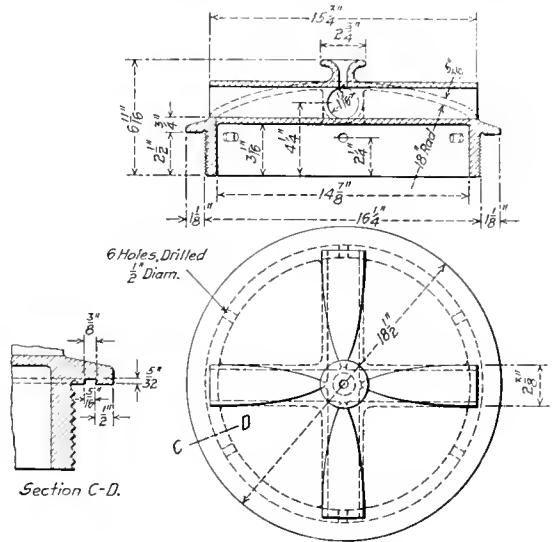

Dome Cover for Oil Tank Car

castings are joined by slip joints and the steam pipes lead to a trap under the tank.

The underframe is designed principally to resist buffing stresses since the tank is largely supported at the bolsters. The center sill is made up of two 12-in. 35-lb. ship chan-

nel push pole pockets are riveted to each end of the bolsters on the side nearest to the end of the car.

The end sills are built up of 4 in. by 4 in. by $\frac{1}{2}$ in. steel angles reinforced on top by a Z-shaped cover plate $\frac{5}{16}$ in

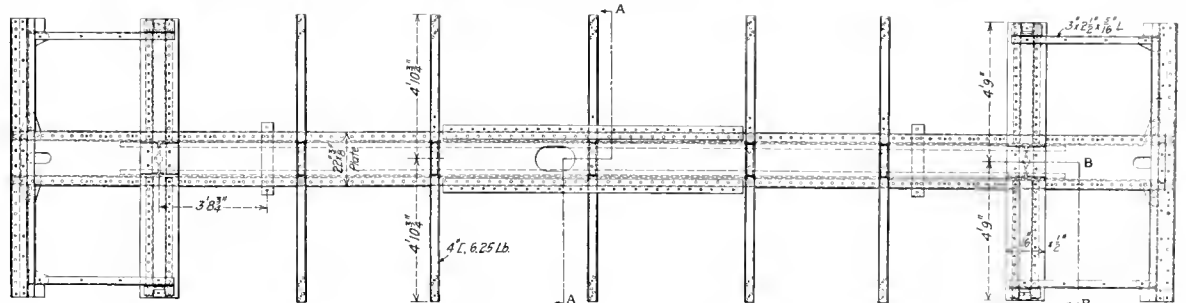
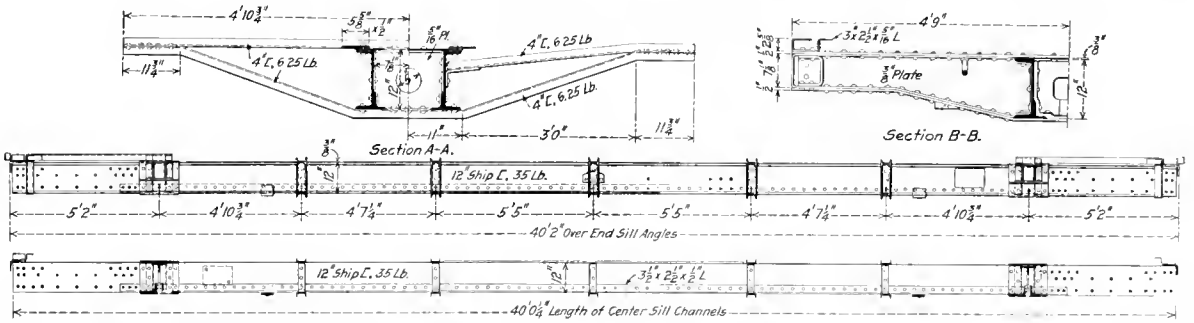

Underframe of the Santa Fe Tank Car.

nels spaced $14\frac{1}{4}$ in. back to back, reinforced on the top by a $\frac{3}{8}$ -in. cover plate 22 in. wide extending the full length of the car and at the bottom by two $3\frac{1}{2}$ in. by $2\frac{1}{2}$ in. by $\frac{1}{2}$ in. angles, extending 16 in. beyond the centers of the bolsters. Five stiffeners of pressed steel are located between the

thick. The ends of the end sills are supported by 3 in. by $2\frac{1}{2}$ in. by $\frac{5}{16}$ in. angles connected to the bottom flange of the center sill channel.

The tank is secured against end shifting by anchors 10 ft. long of $\frac{1}{2}$ in. pressed steel. These are secured to the bottom

of the tank with $\frac{3}{4}$ in. rivets and are fastened with 1 in. bolts of double refined iron to anchor supporting plates $5\frac{5}{8}$ in. wide, $\frac{1}{2}$ in. thick and 10 ft. 4 in. long.

The end running boards are supported by the end sill cover plates by Z-shaped brackets of $\frac{1}{4}$ -in. plate. The side running boards are supported between the end sill and the body bolster by 3-in. by $2\frac{1}{2}$ -in. by 5 16-in. angles. Between the bolsters four supports are provided which are

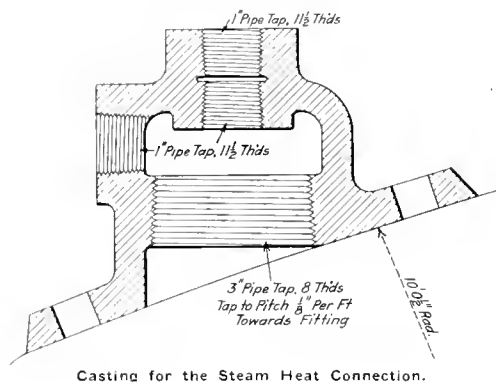

Casting for the Steam Heat Connection.

formed of 4-in., 6 1/4-lb. channels placed back to back under the running board and riveted together, one running over the top and one under the bottom of the center sills, to which they are also riveted.

The draft gear is of the friction type Miner class A-18-R. The draft lugs are of cast steel, the front and rear lugs on each side forming an integral casting. The coupler yokes are of open hearth steel, $5\frac{1}{2}$ in. by $1\frac{1}{2}$ in., fastened to the couplers with rivets of double refined iron. The couplers have 5-in. by 7-in. shanks and $9\frac{1}{8}$ -in. butts. The coupler

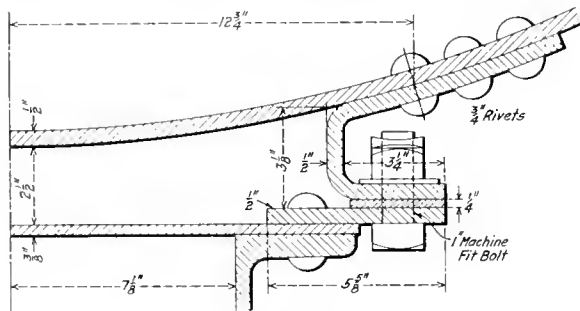

Method of Attaching the Tank to the Frame.

is supported by a carrier wearing casting placed on the carrier iron which furnishes a large bearing surface and reduces the wear on the coupler.

The trucks are of the Andrews cast steel side frame type with cast steel truck bolsters equipped with Barber roller lateral motion device. Cast iron wheels and malleable iron journal boxes are used. Among other specialties are Westinghouse brakes, Simplex couplers, Creco brake beams, National malleable journal boxes and the Imperial uncoupling arrangement.

THE VALUE OF MECHANICAL ENGINEERING.—Nowadays most of the civil engineer's work is done by machinery. The mechanical engineer is called in at the inception of every big undertaking, whether civil or military; and those not thoroughly grounded in mechanics have to take a back seat. —*Railway Gazette, London.*

STRESSES ON END FRAMING OF CARS

BY H. J. HENNESSEY

Calculations covering the stresses on end framing of cars by the action of the lading when abrupt changes in the speed are encountered, have been very vague or unreliable. The following method is submitted for consideration:

Maximum buffer shock which the car will sustain (freight 150,000, passenger 300,000) the force necessary to bring a moving car to rest instantly A
 Light weight of car B
 Load C

$$\text{Foot-pound factor} = \frac{H + C}{A} = D$$

Referring to the following table, opposite the foot-pound factor, corresponding to D, will be found the speed of car in miles per hour (E) and feet per second (F).

Foot Pound Factor (D)	Miles per Hour (E)	Feet per Second (F)
.033	1	1.4167
.134	2	2.9167
.300	3	4.3333
.535	4	5.7500
.930	5	7.7500
1.200	6	8.7500
1.640	7	10.2500
2.140	8	11.7500
2.640	9	13.1667
3.500	10	14.6667
4.070	11	16.0833
4.820	12	17.6667
5.660	13	19.0000
6.550	14	20.5000
7.480	15	21.9167
13.36	20	29.25
20.88	25	36.67
30.12	30	44.00
40.80	35	51.25
53.50	40	58.58
67.60	45	65.75
83.40	50	73.25
100.00	55	80.75
120.00	60	88.00

Disregarding friction of the lading on the floor or sides of car and considering the load moving at the rate F feet per second at the time the movement of the car is stopped, the load will strike the end of car with a force equal to that of a body falling a distance of G feet, which will be found in the following table, opposite the proper value of F.

"F" Velocity Feet per Sec.	"G" Height of Fall, Feet.	"F" Velocity Feet per Sec.	"G" Height of Fall, Feet.
.25	.0010	20.	6.22
.50	.0039	21.	6.85
.75	.0087	22.	7.52
1.00	.016	23.	8.21
1.25	.024	24.	8.94
1.50	.035	25.	9.71
1.75	.048	26.	10.50
2.00	.062	27.	11.30
2.50	.097	28.	12.20
3.00	.140	29.	13.10
3.50	.190	30.	14.00
4.00	.248	31.	14.90
4.50	.314	32.	15.90
5.00	.388	33.	16.90
6.00	.559	34.	17.90
7.00	.761	35.	19.00
8.00	.994	36.	20.10
9.00	1.260	37.	21.30
10.00	1.550	38.	22.40
11.00	1.880	39.	23.60
12.00	2.240	44.	30.00
13.00	2.620	51.	41.00
14.00	3.040	59.	54.00
15.00	3.490	66.	68.00
16.00	3.98	73.	83.00
17.00	4.49	81.	100.00
18.00	5.03	88.	125.00
19.00	5.61		

Therefore, the force of the blow exerted against the end of the car by the lading is:

$$C \times G = H \text{ pounds.}$$

Consider the end frame a beam uniformly loaded for a length equivalent to the height of load in car, extending from one point of support. The bending moment of the end and corner posts and braces can then be figured in the usual manner for box cars, assuming the beam supported at end sill and end plate and for gondola cars consider the end stakes a beam supported at one end.

The foregoing is calculated on the assumption that the end frame will retard the lading and absorb the shock without distortion or penetration.



SHOP PRACTICE



FORGING MACHINE WORK AT SILVIS SHOPS

At the Silvis shops of the Chicago, Rock Island & Pacific, many parts are made in quantities and distributed through the store department over the entire system. The production of large amounts at one time has naturally led to the development of the cheapest and quickest methods of doing the work. One of the most interesting features of the practice

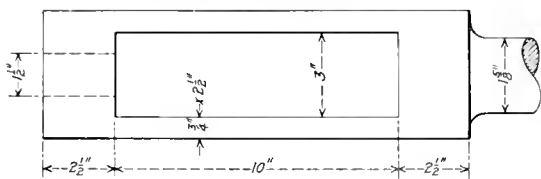

Driver Brake Slack Adjuster Made on a Forging Machine

in the blacksmith shop is the extensive use of forging machines.

It has been found possible to do much work on the forging machines that was formerly shaped or welded under power hammers. Some parts which are usually made on automatic machines are also turned out at a considerably lower cost for both labor and material on the forging machines. An example of this is the spring roller pin shown below. These were formerly made from 1 7/8-in. bar stock, the center portion being turned down in an automatic machine. They are now made on the forging machine, 1 1/4-in. stock being used, and the enlarged ends are formed by upsetting. The saving of labor and material by this method amounts to 20 cents

on a single item was the result of a change in the method of making beading tools. It had been the practice to forge these oversize and mill them to the contour desired. The corners were then rounded by filing. It was found possible to produce a tool of almost exact shape required on the forging machine, the only finishing needed being filing off the fins. The saving by this method amounts to \$.58 for each tool or \$2,106 per year.

In making draw bar pins the head is upset and the hole for the key is then punched in the other end. This not only saves labor as compared with the method of drilling the hole for the key, but it reduces the amount of handling required as well.

The reduction in the cost as compared with forging by hand has shown the economy of making dies for all parts

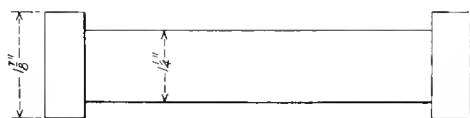

Spring Roller Pins Made on a Forging Machine

which are used in considerable quantities. On engine truck swing links, which are finished at one heat in the forging machine, the saving in labor is \$1.16 each. Cranks for velocipedes, the labor cost of which formerly was \$1.28, are now made at a cost of \$.05 each. Clevises for safety chains now cost \$.085 each as compared with \$.44 when made by hand. In making safety chain hooks, the eye is first formed under a Bradley hammer. The piece is then bent in a bulldozer and finished in the forging machine. Eyebolts for

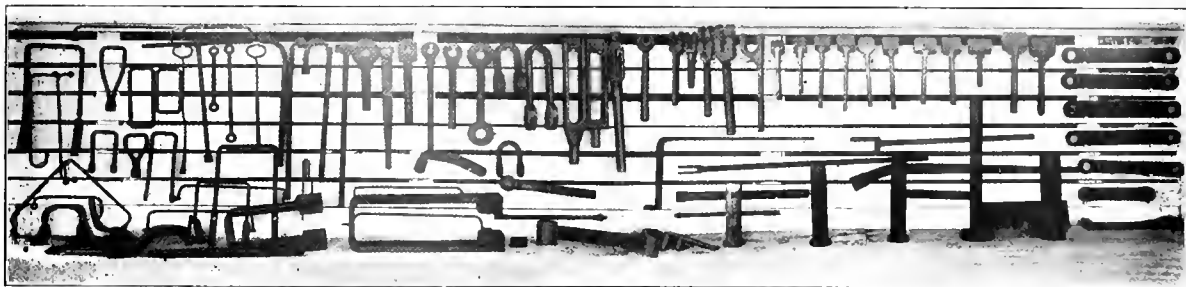

Example of Some of the Forging Work Done at the Silvis Shops of the Rock Island.

for each piece. Brake rigging pins are made in the same way. Bushings for flexible staybolts also were formerly made on automatic machines. It was necessary to turn them from solid bars and the cost was \$.025 each. Dies have now been made for forming these parts on the forging machine and the cost has been reduced to \$.0044 each. It should be borne in mind that when such parts are forged it is often possible to use scrap material, thus effecting a further saving.

One of the largest savings which has been brought about

safety chains are formed on the forging machine alone.

Among other parts for which dies have been made are ashpan wrenches, grate shaker bars, yokes for Waugh and Sessions draft gear, brake hanger posts, spring bands, eccentric blade jaws, knuckle pins, and screws for reversing gear. The last named parts when forged under a steam hammer cost \$2.04 each, but they are now made at a cost of \$.18 each.

Brake shoe keys when made under a power hammer cost

\$.02 each for labor, while the present cost of making them on the forging machine is \$.00375 each. Brake beam hangers with welded eyes are made on the forging machine which not only produces a stronger hanger, but reduces the cost as well. Strap spring hangers which when made by hand cost \$.96 each are now turned out in one heat on the forging machine at a labor cost of \$.16. The parts produced on the machine are far superior to any made by hand. The saving in this item amounts to \$1,960 per year.

A rather difficult piece of work is the end for the driver brake slack adjuster, shown in the sketch. These are made in two heats on the 4-in. machine. The block for the end which carries the screws is placed in the machine between the two $\frac{3}{4}$ -in. by $2\frac{1}{2}$ -in. side pieces and welded. The other end is made in much the same manner, the $1\frac{5}{8}$ -in. rod and a small block being placed between the ends of the side pieces. This piece is now made at a cost of \$.37 each as compared with a former cost of \$2.76.

At the present time the forging machine equipment at Silvis consists of one 4-in., one 3-in., one 2-in., two $1\frac{1}{2}$ -in. and two 1-in. machines. A 6-in. machine is now being installed on which it is planned to make drawbars, side rods, motion parts such as radius bars and eccentric bars. Dies will also be made for reclaiming axles.

LATHE BORING TOOLS

BY M. HERBLIN

The drawings and photographs show a lathe boring tool holder and a drill socket that have been in use at the Nashville, Chattanooga and St. Louis shops at Nashville, Tenn.,

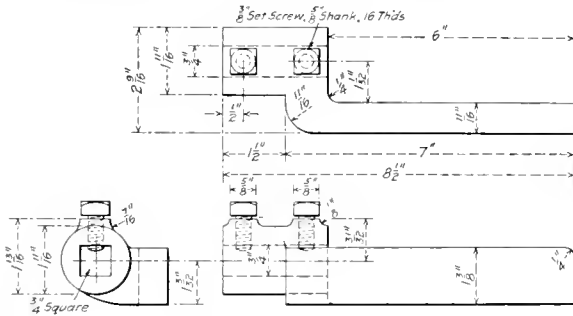

Details of the Lathe Boring Tool Holder

for some time, where they have proved very efficient.

The lathe boring tool holder is made with the desired off-

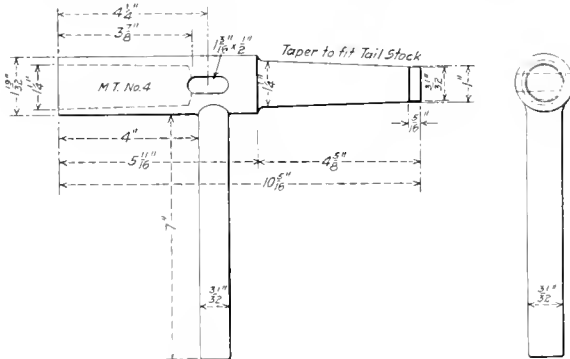

Drill Socket for a Machine Lathe

set, having a shank $1\frac{3}{8}$ in. by 11-16 in. High speed tools, $\frac{3}{4}$ in. square, are held in the holder by two $\frac{3}{8}$ -in. set screws. The entire length of the holder is $8\frac{1}{2}$ in. The

proportion of the holder may be changed so that much larger or smaller tools can be used. The tools are easily removed for grinding and they may be adjusted to suit the various depth of holes with but little trouble. This tool holder has a number of commendable features. It is very rigid and uses high speed steel tools that can be made economically, but little material being wasted.

The drill socket is used for drilling holes on a lathe. The

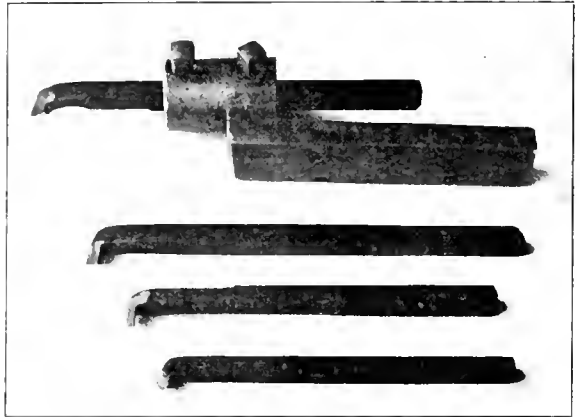

Lathe Boring Tool Holder For High Speed Steel Tools

stem is turned to fit into the tail stock center. This holds the drill in perfect alinement and eliminates the trouble caused by the socket slipping from the tail stock center when the drill pushes through the work, as is the case with other sockets. The tail or arm of the drill socket is long enough to rest on the tool carriage and it relieves the tail stock of all torsional strain. This tool has been found very satisfactory and useful. It is made from $1\frac{5}{8}$ in. material, the arm being 31-32 in. in diameter. It has a No. 4 Morse taper and is 10 5-16 in. long.

FOLDING HORSE FOR SHEET METAL WORK

A device used in the Dale Street shops of the Great Northern which has been found very useful for jacket work in the erecting shop is a folding leg horse, a drawing of which is shown below. The legs are of No. 10 gage sheet steel bent to form an angle, and hinged so that they can swing inward.

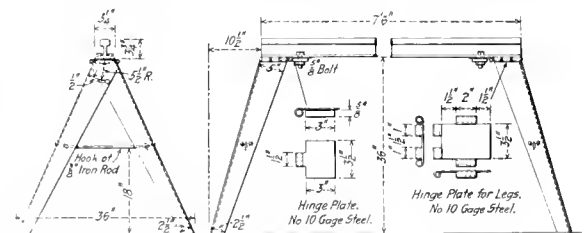

Tinners Horse with Folding Legs

The plates to which the legs are fastened swing downward so that each pair of legs will fold over against the rail which forms the top of the horse. Since there is a considerable load on the inner hinge plates they should be held by a piece of $5/8$ -in. iron fastened to the base of the rail with two $5/8$ -in. bolts. A rail weighing about 40 lb. to the yard is the most convenient size for such a horse.

BOILER SHOP APPRENTICESHIP METHODS

The Santa Fe System Is Steadily Progressing With Its Educational Work in This Important Department

THAT the problem of boiler maker apprentice is regarded as of special importance on the Atchison, Topeka & Santa Fe is indicated by the large amount of attention that was given to it at the ninth annual conference of the apprentice instructors on that system. So important was the discussion of this subject considered that the convention was extended an additional day over the time allotted in order to complete it. The more important points of the discussion are covered in the article which follows. A similar report of the proceedings of the eighth annual Santa Fe apprentice instructors' conference will be found on page 415 of the August, 1916, issue of the *Railway Mechanical Engineer*.

ROUNDHOUSE BOILER WORK

This subject brought forth considerable discussion and no little criticism over past methods. It was found that entirely too much time had been given to finding a boy's weak points when transferred to another shop, so that his lack of knowledge could be criticized. It was agreed that this course should be discontinued and every effort be made by instructors to see that each boy is given the proper class of work. The instructor should feel just as much responsibility for the thorough training of a boy from another shop as for one of his own boys. When a boy is transferred from the back shop to the roundhouse, the shop instructor should furnish the other instructor and foreman a statement showing each class of work the boy had performed. Upon the boy's arrival, the instructor should talk with him and learn just what class of work he most needs, and what he is most deficient in. He should then consult with the foreman, and see that this work is given him. The assistant boiler inspectors who were present emphasized the importance of the apprentices being given experience in roundhouse work, and promised to do everything in their power to see that they were given a more thorough training than had been given these apprentices in the past.

FEDERAL AND COMPANY RULES—HOW TAUGHT?

It was suggested that these rules should be taught while the boys are engaged in the work to which they apply. Each apprentice will be supplied with one of the company's rule books, and should be made to study it during his apprenticeship. It was suggested that one school period each month should be devoted to the discussion of the boiler rules with the general boiler inspector, or one of his assistants, acting as chairman; the boiler foreman should be present, whenever possible. Not only should the rules be learned, but the boys should be taught their meaning and application. Failure to comply with these rules generally means defective work, and defective work endangers life and property.

WORK DURING FIRST SIX MONTHS

One instructor advocated a change of work each month during the first six months in order to study the nature and ability of the boy, and acquaint him with the work of the shop and his trade. He recommended increasing the kinds of work gradually from light to heavy, letting the boy learn during this period something of the different classes of work in the boilermaker's trade. This would also give the instructor an opportunity to study the boy, and would keep the boy interested and help to hold him on his apprenticeship, whereas, if he is kept too long on one class of work,

especially at the start, he is likely to become discouraged and give up his apprenticeship. It was suggested that the apprentice be given some work in heating rivets during this first period, but that he should not be kept longer than two weeks on this class of work. During the first six-months' period he should have some sheet iron work, some work on ash pans, and some work in the tank room.

It was also suggested that shop instructors be placed at several of the smaller points, as they are greatly needed at such places. It is a paying proposition to give the boys a chance, to give them thorough experience in all classes of work.

One instructor recommended placing a boiler shop instructor at every point where there were at least five boiler-maker apprentices; with such an instructor the number could probably be increased to ten or twelve. A foreman should not be allowed to keep a boy on any class of work simply because he has become proficient in that particular work and is of some personal help to the foreman in remaining there. The instructor should work in harmony with the foreman, but should see that the apprentice gets the experience needed to develop him into an all-round mechanic.

SUGGESTIONS FOR IMPROVING THE COURSE

G. Austin, general boiler inspector, brought out the inadvisability of attempting to train all apprentices for the more generally specialized classes of work, saying that all are not adapted to such training. He also recommended that efforts be more thoroughly devoted towards the development of mechanics rather than of foremen; that only a few could be selected for foremanship, while the mechanics were greatly needed. He stated, too, that there were a lot of good boys who could be developed for "coarser" work, whose ability would prevent their absorbing the special training which would be of advantage for certain of the brighter boys.

A greater number of boiler shop apprentice instructors was recommended; wherever five or more boiler-maker apprentices are employed, a shop instructor should be appointed; it would then probably be possible to increase the number of apprentices.

The practice of advancing boys by specified time periods was discouraged, it being thought better to advance them according to their progress and ability. It was suggested that special meetings be held, say once a month, in the apprentice school room, the general boiler inspector, or one of his assistants, giving a lecture or other form of instruction to the apprentices and having the foremen and instructors present.

A more thorough training in the use of hand tools was recommended because of the limitations of pneumatic tools.

When defective parts of boilers are removed the attention of the apprentices should be called to the cause of removal, and the possible cause or the reasons which brought about this condition. It was also suggested that it would be well for the boiler inspector occasionally to take the older boys with him on a general inspection, when at terminals, to see what is being inspected, and why. It was suggested that in teaching laying-out work in the school room it would be well at times in addition to using drawing papers to lay the object out and cut and flange it from light weight iron.

It was also recommended that every apprentice be sup-

plied with a book of boiler rules, and be taught the information and instructions therein.

SCHOOL ROOM COURSE FOR BOILERMAKERS

This subject has been discussed by the instructors for some time and the need for a distinctive course for boiler-maker apprentices is apparent. The course as recommended will differ but slightly from the regular school work for machinist apprentices for the first nine months. The first 50 lessons in drawing will be the same, after which such drawings as relate to boiler work, radial development, intersections, triangulation, etc., will be begun. The work in the school room should at all times be as closely related as possible to the shop work being done by the boy. A definite number of drawings and problems must be completed by each apprentice during each six-months' period.

In laying-out work taught in the school room the boy should work from prints similar to those used in the shop. Each step should be thoroughly understood before taking up advanced work.

In mathematics, the course will include in addition to the present problems specially prepared problems on boiler work, strength of materials, riveted joints, including the use of formulas. It is imperative in these days for a boiler-maker to be able to use formulas for calculating seams, joints, staying, etc. Boiler-maker apprentices should be taught enough of the principles of algebra so they may be able to obtain an adequate working knowledge of these formulas.

Questions on boilermaking will be used as a guide and should bring to the boy's mind the important features of his trade, which he should know and remember. The questions will be given at regular intervals throughout his apprenticeship, but in the last six-months' period he will be required to write out answers to all questions. This will be a review, and will enable the instructor to ascertain if there are any features with which the boy is not thoroughly familiar; and if so, he will be able to go over the subject with the apprentice before he graduates.

LAYING OUT—HOW TAUGHT IN THE SHOPS

It seems to be the general practice of the boiler shop instructors to give the apprentices sheet iron work and light laying out in their first year, and heavy laying out, such as belly patches, side sheets, back sheets, door sheets, throat sheets, flue sheets, etc., in the fourth year of their apprenticeship. The apprentice should work with the regular layer out, or where there is more than enough work for one man, the instructors should be in charge and give the apprentice the necessary instructions. The boys at many places are given laying-out work in the school room. This should conform with the work he is doing in the shop at that particular time. The object should be laid out on as large a sheet of paper as convenient, and should later be cut and rolled to shape.

STATIONARY BOILER RULES

Owing to the introduction and passage of so many state laws regulating the care and maintenance of stationary boilers, it was suggested that additional questions be added to the list of questions for boiler-maker apprentices covering the principal features of the new state laws. While the majority of these requirements are covered by the Santa Fe book of boiler rules, still there are some features that are not covered, and it was suggested that whenever a state passes any law or adopts any rule as to the care and maintenance of stationary boilers, the apprentice schools in that state should provide copies of these regulations for the information of the instructors and the thorough instruction of the apprentices.

QUESTIONS ON BOILERMAKING

Questions recently prepared on boilermaking for the instruction of the boiler-maker apprentices had been previously assigned to the boiler shop instructors, who had been asked to write out the correct answers to these questions. These answers were thoroughly discussed with the shop instructors and with the general boiler inspector and his assistants, and after a thorough discussion, they were submitted to the general boiler inspector for verification, with the understanding that each boiler shop instructor would later receive a copy of the correct answer to each of the questions, in order to compare it with the one he had previously submitted, and that he might be sure of the correct answers and interpretations.

BRICK ARCHES

G. M. Bean, western representative of the American Arch Company, suggested that while formerly the brick arches were applied as fuel savers, they were now considered more as boiler capacity increasers. A great benefit is secured from arch tubes as a circulating agent and in increased evaporation. Mr. Bean spoke of the necessity of taking good care of the bricks in storage, keeping them under shelter and free from moisture; avoid rough handling as all fire brick is more or less fragile, and cannot be handled like stone or vitrified brick. The design and location of the arch tubes is the result of considerable experiment, and the shape and position of these tubes indicated on the blue prints should always be adhered to. Keep the flues clean, especially the lower ones. While at times it may be inconvenient to get to them, it is necessary that they should be kept clean if economical results are to be accomplished. When the arches are properly applied and maintained, longer life will result for both flues and fireboxes, as the arches will distribute the heat more uniformly over the entire firebox; on account of the even distribution of the heat the cinders and gases will be consumed rather than pass through the flues and out of the stack, thereby making it a smoke consumer.

LOCOMOTIVE SUPERHEATERS

R. R. Porterfield, of the Locomotive Superheater Company, gave an illustrated talk to the instructors on the installation and maintenance of the superheater.

APPLICANTS—HOW SECURED

Arthur Irving, Chanute, Kan., was assigned to this subject owing to his success in securing applicants at Chanute. He attributed his success in securing these applicants to his being in thorough touch with each of his apprentices; most of the applicants had been secured from among friends of his apprentice boys, or from friends of their friends. There are various ways of securing applicants—by solicitation through the apprentices, fraternities, Sabbath schools, or occasionally talking with a small gathering on the street, when he happened to be down town. He also had found it a good plan to occasionally go to the neighboring towns, and talk with the young men there. It was suggested that the instructor should keep in close touch with the public schools, occasionally giving a talk to the high school students, or at least explaining the situation to the high school teachers in order that they may present the matter to such of their pupils as are interested.

All the instructors agreed that loafers, or boys from poolrooms, made very poor apprentices. In talking to a prospective applicant, it was pointed out that the young man should be made to realize that in this day and age it is very necessary to have either a good education or a trade, or better still, both; that unless he has one or the other he will be doomed to work for mere laborers' wages, and be compelled to compete with the lowest class of laborers. If

this matter is thoroughly brought to the attention of these young men, many of them will be induced to go into a shop to learn a trade.

Mr. Irving pointed out that the instructor could well afford to make a personal sacrifice occasionally to help out some deserving boy, who perhaps is unable to pay the surgeon's fee, or possibly unable to pull through during the first period of his apprenticeship.

When a prospective applicant complains about the apparently low rate of pay, he explains the reason for this, and also calls attention to his having a chance to work every day and to what the average wage throughout apprenticeship really amounts to. Each boy is urged to look toward the future and make his plans accordingly.

In giving the school examination to applicants for boiler-maker apprentices, all agreed that the instructor must make considerable allowance and if the boy seems physically strong, of clean morals, and is ambitious, that he should not be rejected on account of his deficiency in schooling. The importance of the moral element in passing upon the fitness of a boy for a trade was emphasized. In connection with this, the subject of cigarette smoking was thoroughly discussed. If a boy is addicted to this habit, he should be taken in hand and be given a fatherly talking to. If the boy does not quit smoking cigarettes, he should be made to understand that he must either quit the habit or give up his trade; usually the boy chooses to give up the cigarettes.

The instructors reported that a higher rate should be paid in order to attract boiler-maker apprentices. At some points there seem to be plenty of applicants, but when the question is raised of sending some of these boys to other points, it has been found that although they could live at home on the wages paid, they cannot go to another shop where they have neither credit nor relatives, and be able to pull through. It was suggested that in certain cases relief might be obtained by employing prospective applicants first as rivet heaters. This would give the boy a chance to become familiar with the shop and in certain cases enable him to get a little bit ahead financially, before starting on his apprenticeship. The question is under consideration of letting the boiler-maker apprentices, or at least the most deserving ones, serve a part of their apprenticeship, say six months, in the machine shop, in order that they may be better prepared for promotion when vacancies occur.

DIE FOR REPAIRING THREADS ON CROSSHEAD PINS

The details of an adjustable die which is very useful for cleaning up injured threads on cross-head pins, knuckle

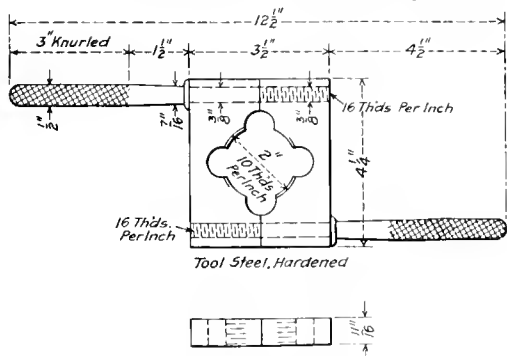

Adjustable Die for Cleaning Up Battered Threads on Crosshead, Crank and Knuckle Pins

joint pins and crank pins are shown in the drawing.

When men are working around an engine, or when the pins are being handled, it often happens that the threads are

damaged. They have to be only slightly battered to prevent the starting of a nut on the end of the pin. To secure a large socket die to clean up threads in this condition is inconvenient and rather expensive because of the time usually required. Where the threads of this description are standardized on the various classes of engines, the simple adjustable die, which may always be kept at hand for the purpose, is equally as effective and much more convenient.

The die is made in halves which are joined by handles placed at diagonally opposite corners. Each handle passes through one die and is threaded into the other. To use the die it is opened and slipped over the end of the pin, after which it is closed on the thread by screwing up the handles. The threads are cleaned up by running the die off the pin.

RADIAL LINK GRINDER

BY J. H. CHANCY

Foreman Blacksmith, Georgia Railroad, Augusta, Ga.

In many shops no provision is made for resurfacing valve motion links except to anneal them and true them up on the bench by draw filing. This requires anywhere from two to three days' work. In order to make it possible to do this work by grinding without the necessity of annealing the links, a simple radial attachment was developed by F. B. Kuhlke, in charge of rod and link work at the Augusta Shops of the Georgia Railroad, which is used with an ordinary two-wheel pedestal grinder.

The foundation of the radial attachment is a column 2 in. by 2 1/2 in. in section and 40 in. long, with flanges at the top and bottom to which are bolted brackets of 5/8-in. by 3-in. material. These brackets support the column from the

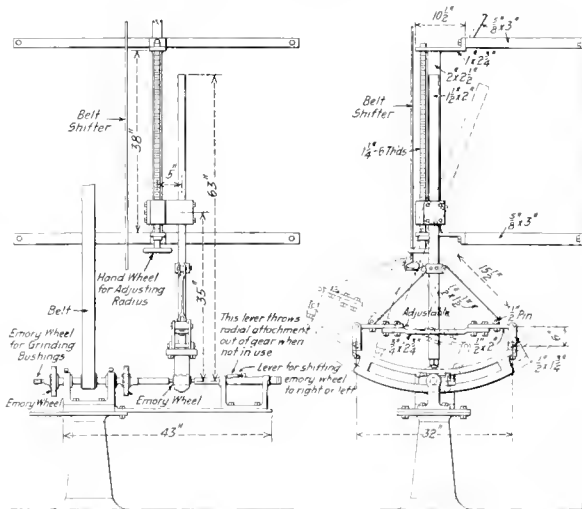

A Shop-Made Radial Link Grinder

wall of the shop. The flanges at the end of the column also serve as bearings for a long 1 1/4-in. screw with a hand-wheel at the lower end. Mounted on the column is a sliding head, the position of which is adjusted by the screw. To one side of this head is pivoted a block in which the adjustable radius arm is clamped.

The method of attaching a Southern valve gear link to the radius arm is illustrated in the drawing. The yoke to which the ends of the link are attached with eye bolts and 6-in. links of 1/2-in. by 1 3/4-in. material, is triangular in form, the base being connected to a sliding block on the radius rod by two 1/2-in. by 1 1/2-in. links, 15 1/2 in. long. With the sliding block properly adjusted and securely clamped to the

radius rod, the valve motion link is rigidly supported by a jack screw in the end of the radius rod which may be set up tight against the inner curve of the link. In adjusting either Stephenson or Walschaert links, turnbuckles are used in order that the link may be accurately squared up with the radius rod.

To one side of the grinding wheel stand is attached a bracket, the outer end of which contains an outboard bearing for the link grinder shaft and a shifting lever arranged to throw the link grinder attachment out of gear when its use is not required.

By means of the adjusting screw on the column of the radius attachment, the pivot of the radius arm may be raised or lowered on the column to provide for a range of link radii from 35 in. to 63 in. After the radius arm has been adjusted to the proper length in the pivot block, the final adjustment of the height of the pivot is made with the hand-wheel so that the grinding wheel may be passed through the link, and the work fed against it.

The machine was built at a nominal cost of about \$50, most of the material used being selected from available scrap. It was built in the shop at such time as the labor could be spared from the regular work. With this machine, work that originally required from two to three days' draw filing by hand, may now be done with better results in two hours.

GAP RIVETER FOR STEEL CAR REPAIRS

BY "APEX"

The gap riveter shown in the illustration is used for riveting sheets in open steel cars on a South African railway. It is made up of a 5-in. pipe bent as shown and in the ends of



Gap Riveter for Repairing Steel Cars

which are placed the anvil and air operated plunger. It is hung on a cradle made from 1½-in. by 1-in. bar iron with

bossed ends for the trunnion pins. These pins are contained in clamps made of 3½-in. by 5-in. material. These clamps are bolted securely to the pipe and are so placed that the machine is nicely balanced. The riveter is supported by a chain hoist on a crane by a shackle at the top of the cradle so that it may be adjusted to any desired position. While it is not claimed that this riveter will perform the work faster than when a hand riveting machine is used, it is much easier for the workmen and a better rivet is made. It has been found to be especially advantageous where heavy repairs are made or new work is being done.

AIR PRESS FOR ROD BUSHINGS AND DRIVING BRASSES

BY E. A. M.

A convenient air press which can be made in most any shop and which has been found particularly serviceable in rod and driving box work, is shown in the illustration. The cylinder of the press has a diameter of 30 in. The press is made up of a base 4 in. thick by 47 in. square with a tongue

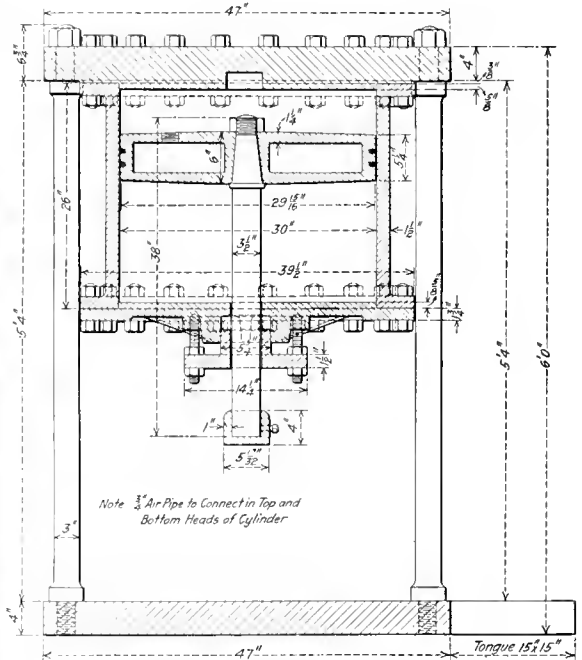

Air Press of 70,000 Lb. Capacity

on one side 15 in. square. This projection is left on the base as it enables the operator to get the work on and off the press easier. Four wrought iron upright columns of 3-in. diameter are screwed into the base and the top plate of the press is held to these rods by four 2½-in. nuts.

The air cylinder walls are bolted to the top plate by 20 1¼-in. bolts. The underside of the top plate is cut away as indicated in the illustration to permit the top plate fitting into the cylinder, the upper plate forming the head of the cylinder. A cast iron piston with two packing rings is used on a 3½-in. piston rod. The bottom head of the cylinder is fastened to the wall by 20 1½-in. bolts. It is strongly reinforced by six ribs. A suitable packing gland is applied on this end of the cylinder. It is made of brass and held in place by two 1-in. studs. The cylinder may be operated by the regular three-way valve and at 100 lb. air pressure it will provide a pressure of about 70,000 lb.

FEDERAL INSPECTION REQUIREMENTS*

A Suggested Outline of the Methods Followed in Making Inspections and Keeping Records of Them

WE all realize that in the tremendous strains of present day railway service, equipment in general must necessarily wear out and of course receive necessary repairs at the proper time. In order to determine definitely the condition of the motive power at all times, our attention must be given to the subject of inspection, especially so, where the power is used in pool service. The theory of which is to eliminate defects before the power is returned to service, or if necessary, remove the power from service as soon as defects have appeared. It has become almost universal practice to place the very best mechanic obtainable on this class of work, giving him authority to remove the power from service if necessary to have proper repairs made.

In order to facilitate the handling of the work, as well as other inspections, etc., required by the federal laws, it is imperative that some effective system of procedure be installed.

Realizing the impracticability of attempting to formulate a basic rule whereby the various requirements of the federal laws could be complied with under conditions found at different shops and terminals, it has been decided to arrange the various items under headings, with suggestions as to the method of handling.

Every foreman must necessarily organize a system of procedure to best suit his particular shop conditions.

BOILER INSPECTION

Interior Inspection.—It is general practice to have the interior of the boilers inspected by the boiler shop foreman or his assistant when locomotives are in the back shop receiving repairs. When sufficient number of flues are removed to allow examination, while the locomotive is undergoing light repairs in roundhouse, the foreman in charge of roundhouse boiler work usually makes the inspection. A combination of water and sand blast has been used with some success to remove boiler scale. However, the standard practice is using a special scaling tool with a small pneumatic hammer.

Flues.—Records of flues kept in all boiler shop offices will enable the foreman in charge of boilers to see that the three-year limit is not exceeded.

Exterior Inspection.—In order to relieve the roundhouse of as much work as possible, the entire removal of the jacket and lagging should be made when the locomotive is receiving classified repairs in the back shop, if it is found that complete removal of lagging will be necessary before the locomotive receives the next general repair. This, of course, sometimes results in lagging being removed several months before it is due. However, the stopping of serviceable power, when it is no doubt badly needed, is avoided.

Testing Boilers.—A common method of making the hydrostatic test is by the use of a pump operated by compressed air, arranging a drain pipe to one or two gage cocks so a steady pressure may be maintained in the boiler and at the required amount while the boiler is being examined. The testing of the boiler is witnessed by the boiler shop foreman, his assistant or the regularly assigned inspector.

Stay-bolt Testing.—It is practical to have one or more men regularly assigned to stay-bolt inspecting, as they will soon become highly proficient at this work. They also inspect tell-tale holes, see that they are kept open at all times. The inspection and removal of broken stay-bolts, each time

the boiler is washed, is found to prevent delays to the locomotive when the regular monthly inspection is made. The work of removing and applying stay-bolts should also be assigned to a regular man.

Steam Gages.—If possible, all steam gages should be tested and repaired at a central point and the work specialized. This not only prevents a large amount of repair parts being kept in stock, but insures good workmanship. While isolated terminals are not expected to make extensive repairs to gages, they should, however, be provided with a dead weight tester, in order to satisfy themselves as to the correctness of gages when in doubt.

Safety Valves.—The safety valves should also be repaired by a specialist and handled in the same manner as steam gages wherever practicable. In most cases it is possible to consolidate the work.

Water Glass and Gage Cocks.—It is the practice on a great many roads to clean the scale and sediment from water glass gage cocks at the same time the locomotive is given the monthly inspection. Some roads have a man regularly assigned to this work, and make it a practice to not only clean the water glass and gage cock, but also clean and grind boiler checks and repack all cab cocks every time the boiler is washed out.

Injectors.—It has been found good practice to specialize the repairing of injectors, the work being taken care of in the air brake department and coming directly under the foreman. They should be tested at the engine house upon arrival of the locomotive, as well as before departure.

Washing Boilers.—The round house foreman is held responsible for boiler washings and must see that all plugs are removed and that the boiler is thoroughly cleaned and that the washout card is punched. He must also know that all arch and water tubes are thoroughly cleaned. A convenient card which is made in triplicate for recording boiler washings is shown below:

THE RAILWAY CO.

Spindle of Gage and Water Glass Cocks removed and cleaned by

RECORD OF BOILER WASHING

Place

Eng. Initial

B. H.

Punch month and date Boiler is washed

Jan.	Feb.	March	April	May	June	July	Aug.	Sept.	Oct.	Nov.	Dec.
3	2	1	3	4	5	6	7	8	9	10	11
9	10	11	12	13	14	15	16	17	18	19	20
17	18	19	20	21	22	23	24	25	26	27	28
25	26	27	28	29	30	31					

Filing Reports.—The matter of filing as well as the handling of inspection reports must necessarily be taken care of in a way to best suit local conditions. In order to facilitate the work for the clerk in making out the forms covering various inspections, a form similar to that shown in Fig. 1 has been found of great assistance. This form is made out and signed by the inspectors.

Fig. 2 shows a convenient cab frame to accommodate Forms 1 and 3. The forms as well as the glass can be easily applied or removed, and the forms will be kept in a clean condition.

LOCOMOTIVE AND TENDER INSPECTION

In the general design and construction of the locomotive depends in no small way the cost of maintenance, and in

*Abstract of a committee report published in the advance papers of the General Foremen's Association.

a great many cases, details of an apparently minor nature are overlooked, which cause an endless amount of difficulty in maintaining the power in a satisfactory condition. It is the duty of every foreman to advise his superior officer of any change he thinks would decrease the cost of maintenance in any way. This is particularly true when the company is contemplating the construction of new power.

Inspection and Work Reports.—A system of handling inspection and work reports must be worked out to best suit

and date various tests are due, and should be checked off when completed.

Draw Gear and Draft Gear.—In addition to regular quarterly inspections of draw-bars and pins, safety bars and safety chains, it is good practice to make careful examination for defects at any time the tender might be disconnected from the engine, and lost motion between the engine and tender taken up. The application of radical chafing castings provided with slack adjusting wedge, has been found of great assistance in preventing lost motion between engine and tender.

Cross Heads.—The methods of maintaining crossheads in a suitable condition depends entirely upon the style of cross-

THE RAILWAY CO.	
Engine House	Engine No.
1. Number of flues removed?
2. Were all flues removed?
3. Was dome cap and throttle stand pipe removed?
4. Was lagging on fire box removed?
5. Was lagging on barrel removed?
6. Safety valves were set this day to pop at lbs.
7. If hydrostatic test was made, give pressure applied lbs.
8. Were caps removed from all flexible staybolts?
9. Condition of exterior of barrel
10. Condition of interior of barrel
11. Condition of flues
12. Condition of arch tubes
13. Condition of water bar tubes
14. Condition of firebox sheets
15. Condition of staybolts
16. Condition of radial stays
17. Condition of sling stays
18. Condition of cross stays
19. Condition of throat stays
20. Condition of crown stays
21. Condition of crown bar bolts
22. Condition of crown bar braces
23. Condition of dome braces
24. Condition of back head braces
25. Condition of front flue sheet braces
26. Were steam gages tested and left in good condition?
27. Were both injectors tested and left in good condition?
28. Was boiler washed?
29. Were gage cock and water glass cock spindles removed and were cocks cleaned?
30. Were all steam leaks repaired?
31. Were fusible plugs removed and cleaned?
32. Number of broken crown stays and staybolts removed?
33. Were draw bars and draw bar pins inspected?
34. Were air gages tested?
35. Were air pumps tested?
36. Were distributing or control valves cleaned?
37. Were reducing valves cleaned?
38. Were triple valves cleaned?
39. Were straight air double-check valves cleaned?
40. Were dirt collectors cleaned?
41. Were brake cylinders cleaned and lubricated?
42. Were main reservoirs hydro tested?
43. Were main reservoirs hammer tested?
44. Condition of brake and signal equipment
45. Condition of draft gear and draw gear
46. Condition of driving gear
47. Condition of running gear
48. Condition of tender
Inspector,	

Fig. 1—Form for Recording Boiler Inspections

shop conditions. The locomotive inspector's report and the engineer's report should not be allowed to leave the round-house office, the work being distributed to the repairman on a separate report, similar to that shown in Fig. 3, being signed and returned by the repairman after the work is completed. The repairman's reports are filed in round-house office for reference, and quite often are instrumental in placing responsibility for engine failures.

Ash Pans.—At most locomotive terminals it has been found advisable to have a special inspector for ash pans, grates, shaker rigging and smoke box netting, etc. It is his duty to also make inspection after repairs have been completed, and make necessary notation in record book. A record of this kind is very valuable in case of law suits due to fires along right of way.

Time of Cleaning and Inspecting.—It is essential that an accurate record be kept of all tests, and that the foreman and repairman will have some means of knowing when a locomotive is due for one or more of the various tests. In some instances a test bulletin case is installed at some convenient point in the round-house, where it is accessible to all repairmen. The bulletins should give the engine number

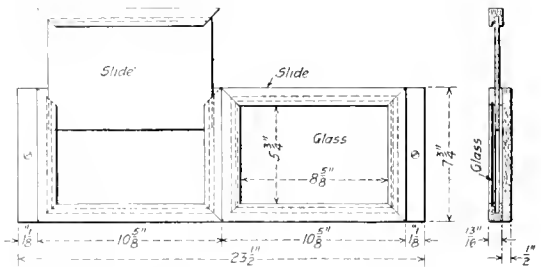

Fig. 2—Cab Frame for Inspection Records

head. Where side plates are used, it has been found practicable to apply two 1/16-in. liners between the crosshead and side plate, which enables repairman to take up 1/4-in. lateral.

Guides.—The common practice is to plane the guide bars when they become worn. However, some shops have found it practical to electric weld the guide before planing, maintaining the original width. They should be relined to the standard spread and sufficient liners applied to insure obtaining maximum wear on crosshead gibs and enable the repairman to maintain the piston rod central in the stuffing box.

Piston and Piston Rods.—Pistons are renewed if worn 3/16 in. smaller than the cylinder when locomotives are

The Railway Co.		
LOCOMOTIVE WORK CARD No. _____		
Eng. No. _____	Eng'r _____ or Insp. _____	Place and Date _____
Work Performed by _____		Date _____

Fig. 3—Repairman's Report

receiving general repairs. A limit of 5/16 in. is the general practice in the round house. Piston rods are given close inspection for defects each time they are removed, the hammer test being found very effective. It is also good practice to anneal the crosshead and piston fits whenever possible. Rods are renewed when reduced to 1/4 in. below the original size, 1/16 in. being allowed for wear at last turning.

Main and Side Rods.—All main and side rods are given special inspection in the erecting shop, the hammer test being used. Side rod bushings are not permitted to go out

of the shop, if more than 3/64 in. larger than pin, and are made larger than pin, and are made 1/16 in. longer than pin to accommodate liners between the collar and pin, for the purpose of taking up lateral. If excessive lateral still exists after liners have been removed, and the rod bushing is still serviceable, a loose brass liner of proper dimensions can be applied. All side rods should be carefully trammed before being placed in position.

Axles.—Driving, trailing, engine truck or tender truck axles are not placed in service if they are out of round, or have a taper of more than 1/32 in. in the length of the journal.

Crank Pins.—It is considered good practice to remove the crank pin when it is worn 3-16 in. below its original size. The outside diameter of the crank pin collars should be at least 1/4 in. larger than the side rod bushing to prevent the side rod interfering with other parts of the locomotive should the bushing become loose while the locomotive is in service.

Driving Boxes.—The use of cast steel driving boxes has almost totally eliminated breakage of this important part of the locomotive. Pouring the crown bearing and the hub plate solid has been found very successful and eliminates loose crown bearings. In order to eliminate the maintenance of solid brass shoes and wedges, the boxes are made 3/4 in. below standard size, and brass liners 3/8 in. thick are applied to the shoe and wedge face of the box. Where

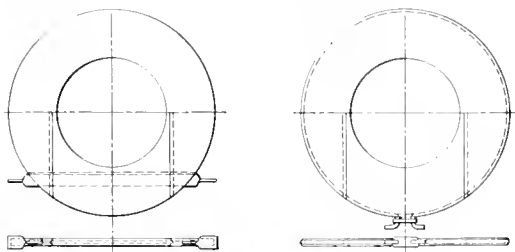

Fig. 4—Type of Lateral Plates that Have Been Used with Success

a brass foundry is available this work can be facilitated by planing dove-tail grooves in the shoe and wedge face of the box and pouring the brass on, the box is then planed to the standard size.

Lateral Motion.—The practice of applying brass plates between the driving boxes and the hubs of driving wheels where the lateral has become excessive is followed generally. However, this is usually considered as temporary repairs. Lateral plates are not difficult to manufacture or to apply, being dovetailed and held together with a key or round iron band fitted into groove around outside edge. (See Fig. 4.)

Spring Rigging.—The use of case-hardened pins and bushings in spring rigging has become a necessity, especially on heavy power. Since the enginemen cannot be depended upon to properly oil the spring rigging, and it is essential that it be lubricated, it is necessary that some one in the round house organization be regularly assigned to this work.

Driving and Trailing Wheel Tires.—All round houses should be provided with a chart, preferably framed and under glass, showing the axle load, diameter of wheel center, minimum thickness of tires for road and switching service, covering the various classes of power, which is not only a time saver, but minimizes the liability of foreman and inspectors making mistakes regarding limit of tire thickness permissible.

Record of Tests.—Book records of all tests must be kept, preferably in one office, which usually requires services of

a special clerk. It is his duty to issue bulletins showing when engines are due for the various tests, write up certificates, see that they are properly signed, and he sometimes holds a notary commission.

It has been found very convenient to make the regular monthly and quarterly inspections at the same time, and the semi-annual inspection with every second quarterly inspection, the annual inspection with every second semi-annual inspection, which not only facilitates handling the work, but is of great assistance in keeping records.

The following are samples of bulletins regarding inspections posted in round houses for the information of the foremen and repairmen:

To all engine inspectors and foreman: May 30, 1917.

The following is list of engines due for Hydrostatic, Quarterly and Flexible tests during the month of June, 1917, also engines due for removal of lagging from barrel:

Quarterly		Hydrostatic	
June 1		257	6-1
June 2	171 237	254	6-16
June 3		78	6-21
June 4	101 232		
June 5	73 173		
June 6	169		
June 7	106 177 232 254		
June 8	160		
June 9	236 249		
June 10	226		
June 11			
June 12	260		
June 13	123 229		
June 14	96 158 252		
June 15	84 264		
June 16	116 127 152 269	Flexible Tests	
June 17	270	260	6-17
June 18	109	225	6-22
June 19		226	6-24
June 20		227	6-30
June 21	128		
June 22	268		
June 23			
June 24			
June 25			
June 26	113 108 235		
June 27	265		
June 28			
June 29	181		
June 30			

Flexible Tests
260 6-17
225 6-22
226 6-24
227 6-30

Lagging
None

To all engine inspectors and foreman: May 30, 1917.

The following is list of engines due for inspection of draw bars, draw bar pins, air gages, air pumps, distilling of control valves, reducing valves, triple valves, straight or double check valves, dirt collectors cleaned and cylinders cleaned and lubricated during the month of June, 1917:

Draw Bars, etc.	3 month test.
73, 77, 78, 79, 84, 86, 90, 96, 101, 106, 107, 109, 113, 116, 123, 127, 128, 152, 158, 160, 164, 165, 168, 171, 173, 175, 177, 179	
Distributing Valves, etc.	6 month test.
86, 106, 123, 152, 158, 177, 226, 229, 232, 235, 252, 254, 257	
Hydro test Main reservoirs	12 month test.
77, 78, 103, 155, 165, 257, 270, 275, 189, 101	
Hammer test Main reservoirs	18 month test.
None.	

The report is signed by: J. B. Wright, chairman; C. D. Rafferty, H. W. Heslin, B. L. Davies and G. W. Ingrand.

SOME OXY-ACETYLENE REPAIRS

Some roads in the bad water districts experience considerable trouble with pitted flues to the extent that the flues do not give anywhere near their proper mileage. At one large

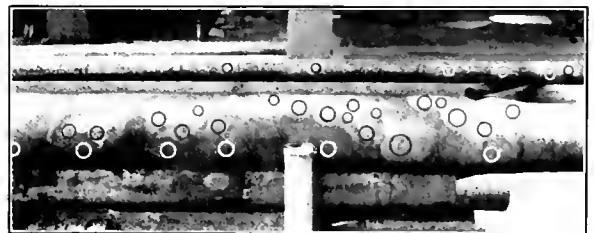

Fig. 1—Pitted Flues Welded by the Oxy-Acetylene Process

shop where these conditions exist it has been found possible to fill up these pits with metal by the oxy-acetylene process. The flues are hammered around the pits so that all scale and

dirt will be removed before the pits are welded. So many pitted tubes are received in this shop that a regular organized force is formed to handle this work. Fig. 1 illustrates the end of a large and small flue which have been repaired in this way. They were picked indiscriminately from a large pile and circles have been drawn around the welded pits in order to bring them out more clearly. These clearly show the extent to which the welding is done. These flues are, of course, in otherwise good condition and the pits have not been allowed to get too deep before the welds are made. Those flues that are too badly pitted are scrapped. This road handled over 6,000 such flues during a year at a cost slightly over one



Fig. 2—Example of Welds on Transoms

dollar per flue. The life of the flue is just about doubled. This represents a very substantial saving, particularly so at the present time on account of the increase in cost of these products.

At this same shop considerable work is done in reclaiming bolsters by the oxy-acetylene welding. Figs. 2 and 3 show examples of some of the work that has been done and that was laid aside to be done. The transom in Fig. 2 had previously been broken, as shown by the white chalk line. The old weld was previously repaired by the oxy-acetylene process and the proximity of the new to the old break indicates how well the first break was welded. A second break occurred,

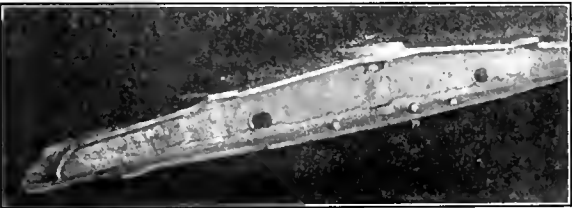

Fig. 3—Cracked Transom to Be Repaired

which was cut out as indicated, by the oxy-acetylene flame preparatory to rewelding. This practice is followed in all such welds. Fig. 3 shows a bolster that was received at the shop to be repaired. This clearly indicates the extent to which this welded work is carried on. On over 300 bolsters thus repaired, a net saving of over \$4,000 was made over the cost of the new bolsters.

This work well indicates what may be accomplished by this process and with the price of materials so high at the present time every effort should be made to reclaim as much material as possible.

MUFFLER FOR USE IN BLOWING DOWN BOILERS

BY C. W. SCHANE

The drawing shows the details of a simple muffler which is in use at the Huntington, Ind., roundhouse of the Erie, for blowing down boilers preparatory to washing out or making repairs. The discharge of steam from the boiler directly to the atmosphere through the restricted opening of the ordin-

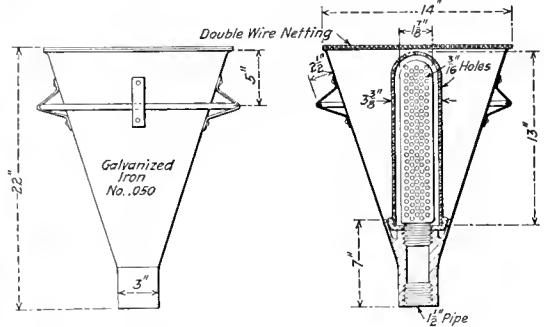

A Simple Shop-Made Muffler for Blowing Down Boilers in the Roundhouse

ary small blow down pipe is extremely noisy and confusing. The muffler materially softens the sound of the escaping steam and makes working conditions in the vicinity much more agreeable.

The device may be made in any pipe shop at very little expense. Two tubes perforated with equally spaced 3/16-in. holes are inserted in the center, and the casing is made of No. 05 galvanized iron. The cover is made of double netting. An iron ring is riveted on the outside in order that the muffler may be handled conveniently when hot.

PROPER ALINEMENT OF LOCOMOTIVE PARTS*

This subject is a very broad one and practically takes in the locomotive in its entirety. A few suggestions are offered with the hope that they may be of benefit.

First—Level the boiler until the center line is in a horizontal position, then level the firebox till the vertical center line is vertical.

Second—Fit the cylinder saddles so the center line will be parallel to the center line of the boiler, regardless of the smoke box, with the back faces at right angles thereto.

Third—Line the frames at right angles to the back joint faces of the cylinders, and thus make them parallel to center lines of the cylinders.

Fourth—Locate the centers of the pedestal jaws on the frames for the shoes and wedges so that the driving boxes and axles will be 90 deg. with the cylinder line (too much care cannot be taken with this part of the alinement). There are quite a number of different methods used in squaring the shoes and wedges, with the object in view of bringing the wheels square with the frames and cylinders, a few of which are as follows:

A line is passed through the cylinders, being made central to the counter bore of each end of the cylinder, and run well back of the main pedestal jaws. A straight edge is then placed across the main jaws at perfect right angles to this line, using a true two-foot square along the straight edge, allowing it to "feel" the line which is drawn through

*Abstract of a paper published in the advance report of the General Foreman's Association.

the cylinders (see Fig. 1). If the straight edge is not perfectly square with the line it will then be necessary to place shims between one of the jaws and the straight edge until it is. After this has been done draw a vertical line on the side of the frame square with the top of the frame and letting the blade of square "feel" the edge of the straight edge. This will be what is termed as the "square line" and from this should be drawn a second line at right angles to the first on each frame and at the same distance down from the top of the frame. From this the centers on the main jaw are located and from these centers and with trams set to the rod lengths the centers on the other jaws are located. After these centers have been obtained lay off half the diameters of the boxes each side of the centers and after the shoes and wedges have been placed in position, with binders tight, draw vertical lines down on the shoe and wedge, half the diameter of the box plus one inch. This line is used for setting up shoes and wedges on the planer, and if the work is properly done this method will answer very well. It should be borne in mind that the cylinder casting should be located exactly central between the frames.

There are various other methods used for lining shoes and wedges, but the object is the same and it is only a difference of opinion as to which is the best. However, whichever method is used it cannot be done too carefully, for without care driving box trouble, rod brass trouble, and

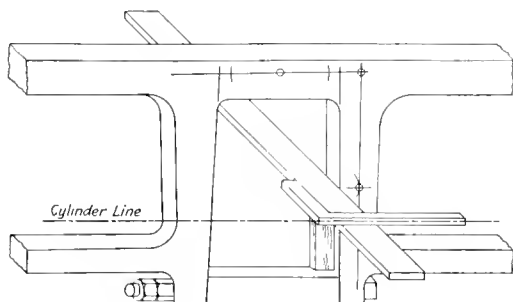

Fig. 1—Laying Out Shoes and Wedges

also the cutting of tire flanges will result. All parts of the engine should fit snug, but go into place without strain.

Improperly located springs, saddles and boxes cause a great deal of unnecessary wear and friction. Strong evidence of this is to be found in any repair shop. Glance at the outside face of the boxes; some are worn on top, and some on the bottom sides, which also indicates unevenly worn brasses. Examine the saddle seats on top of the boxes, and in many cases they will be found to be uneven and not square with the planed surface of the box. While in many cases the spring hangers and saddles are machined and fitted in accordance with a blue print, there will probably be as much difference in the thickness of some of the brasses as $\frac{1}{2}$ in. This is an error that should not go by unnoticed, as it will not allow each box to carry the weight assigned to it, and is an additional cause for friction.

The wheels should be properly quartered. The writer has found some of them out as much as $\frac{1}{4}$ in. and doing business. Longer side rod journals than is the general practice is recommended as the longer the bearing the less friction. It would be well to provide some way of lubricating the bearing in the truck center casting, perhaps by means of a grease plug tapped in at the most convenient place on side. Some sort of a roller bearing for the center casting would also reduce friction.

Careful attention should be paid to the alinement of the guides, both transversely and in a horizontal direction.

This is to take care of undue friction in piston packing and piston rings. There is no doubt that if this is done as it should be the life of the rings, packing and piston rod will be extended.

The valve motion should be gone over carefully, in order not to have too much lead and to see that as much steam is used on one side of the engine as on the other. Any great distortion in the use of the steam, even though the valves are square, will cause a jerky motion and endanger the frames.

The report is signed by B. F. Harris, chairman of the committee.

ELECTRIC ARC WELDING*

BY E. WANAMAKER
Electrical Engineer, Rock Island Lines

The ability of the railroads to meet the demands upon their transportation facilities will be an important factor in the time required for the nation to become effective on the battle fronts. This discussion deals with one way of getting more transportation service out of the railway equipment in existence at the present time. Efforts spent in this direction are as patriotic and necessary as can be imagined. The patriotism of the civilians, particularly of the mechanical engineers in railway service, must not stop with the more or less superficial demonstrations of loyalty to the stars and stripes. Those of us who cannot go to the fighting front must use the best of our abilities to get service, "and still more service," to paraphrase Lloyd George's quotation, from the motive power and rolling stock of the nation's railway systems.

The growing possibilities of the welding processes in motive power and rolling stock maintenance have been a source of amazement to every railway man who has come in contact with the practice. In cutting metal the application of the oxygen cutting processes save from 50 to 90 per cent of the time required to perform the operation. Yet in many of our locomotive shops and car yards the old practices are still followed and our man power for this cause has not produced the maximum result.

The welded fastening came down to us from antiquity. The welded fastening has always been looked upon as a stronger joint than the riveted or bolted fastening. As a general proposition the riveted joint, or bolted joint, has a tensile strength which is considerably less than the tensile strength of the original piece, while the welded joint is as strong as the original section. The welded joint, and particularly the butt welded joint made by an autogenous welding process offers greater strength, with a thickness for practical purposes equal to the thickness of the original plate.

There was a time when worn surfaces of the steel parts in a machine made it necessary to scrap those parts. It was only with the introduction of the autogenous welding processes that it became possible to stop this economic waste.

The repair of broken members of a machine has been another important work of the autogenous welding processes. Prior to their introduction certain steel parts could be welded in the forge fire, but the range of the work was very limited and in many cases its cost equal to the cost of a new part. Now, however, with the exception of cast iron parts, the failure of which would bring death and destruction, practically all parts of a machine which break may be safely repaired.

It is my purpose to point out so far as is possible how far these new practices may be utilized on steam railways to enable the railway systems of the country to meet the present emergency in the matter of service demanded from motive power and rolling stock equipment. The first of the new welding processes, which may properly be called autogenous processes, since the welding takes place more or less auto-

*Abstract of a paper before the Western Railway Club.

matically, was the thermit welding process. This process found a wide application in the repair of broken steel parts on the railroads and the saving which resulted from its use, without doubt aggregated millions of dollars.

Welding with the oxygen and fuel gas flame was the first widely used autogenous welding process. Since everyone is more or less familiar with the gas welding process, this paper will deal primarily with the electric welding process and an extended discussion of the gas process will be omitted. It is sufficient to state that at the present moment the essential difference is in the method of producing the heat for welding, rather than in the fundamental principles involved.

There are two kinds of electric arc welding, known respectively as carbon electrode welding and metal electrode welding. In the former an arc is drawn between a carbon electrode and the piece to be welded and the metal to be added fed into the arc in the form of a "melt-bar." This process is not used extensively in railway work, due to the fact that welding may only be done in the horizontal plane in this manner and that the work is in general inferior to that which is possible with the metal electrode process.

The metal electrode process uses, as the name implies, a metal electrode, the arc being drawn between the electrode and the piece being welded. The heat of the arc melts the metal of the piece and the metal of the electrode simultaneously. As the metal of the electrode melts it is drawn across the arc to the molten metal of the piece where a complete and homogenous union is formed, which we call an autogenous weld. I say the metal of the electrode is drawn across the arc rather than that it falls through the arc advisably, since it will flow straight overhead as well as straight downward. The temperature of the arc is extremely high at its center, actually vaporizing the metal to form the visible arc. With the exception of work with certain electrodes (manganese steel and slag-covered electrodes), the electrode is always made the cathode or negative—that is, the current of electricity flows from the piece being welded to the metal electrode. The reason for this practice is that the greatest amount of heat in an electric arc is liberated at the point at which the current passes from the solid medium to the heated vapor of the arc. Since the metal of the piece has more mass and conducts the heat away from the point at which the welding is being done more rapidly than the electrode, it is desirable to have the greatest amount of heat on the piece. Due to the composition of the manganese and slag-coated electrodes, it is necessary to make these electrodes the positive.

The voltage required for metal electrode welding is approximately 20 volts and direct current power is necessary. The various types of welding equipment are merely different plans for rendering available a rather heavy current at this voltage, and the power economy of the several systems for obtaining this result varies over a wide range.

The successful application of the arc welding process requires the combination of three factors—engineering knowledge, craftsman's skill, enthusiasm. The direction of the practice on our road rests with the engineering staff of the mechanical department; the actual operation is done by skilled members of the boilermakers', pipefitters', machinists' and blacksmiths' crafts. We do not employ novices or apprentices in this work. Only the best men of the respective crafts are picked for operators. It has been plain from the start that only the highest type of craftsmen could secure the results we want and we have witnessed the growth of a considerable amount of pride and enthusiasm in the work among our operators. Even with the best of equipment and facilities for welding, we recognize the fact that it is absolutely necessary that only skilled operators be employed.

Under competent direction, the skilled and enthusiastic operator will seldom make serious blunders in the application of the process. I am quite certain some roads have had

great difficulties in this line among operators made of green apprentices and "handy men." Further, we have found that the skilled craftsman, who is enthusiastic is continually finding new and profitable fields for its application.

COMPARISON OF ELECTRIC WELDING VS. OLD METHODS AND GAS WELDING

Description of parts	Cost old method	Cost gas welding	Cost elec. welding	Saving over old method	Saving over gas	No. engs.
Valve stems	\$7.38	\$15.76	\$4.72	\$11.52	\$10.50	6
Eccentric straps	17.95	7.63	2.38	15.57	5.25	2
Cross heads	1.36	1.04	.34	1.02	.70	1
Piston heads	356.40	120.23	37.73	318.67	82.50	13
Motion saddles	47.93	32.74	10.24	37.69	22.50	4
Frame braces	8.22	10.94	3.44	4.88	7.50	2
Crank arms	99.50	48.90	15.00	84.50	33.00	10
Rocker box castings	18.81	26.14	8.14	10.57	18.92	5
Expansion bar	4.59	7.29	2.34	2.95	5.25	1
Reach rod	2.80	4.38	1.38	1.42	3.00	2
Rocker arms	1.25	1.09	.34	.91	.75	1
Eng. truck equalizers	20.75	13.24	4.24	16.51	9.00	6
Truck frame	7.70	17.24	5.24	2.46	12.00	2
Trailer jaws	15.70	13.04	4.04	11.66	9.00	3
Trailer frame	2.76	4.38	1.86	1.40	3.02	1
Extension piston cross head	6.30	4.36	1.36	4.94	3.00	1
Brake beams	1.69	2.18	.68	1.01	1.50	1
Brake hangers	5.10	7.45	3.40	1.70	4.05	3
Smoke arch braces	3.50	6.25	2.14	1.36	4.11	1
Air pump valves	2.50	1.33	.53	1.97	.80	1
Lugs on valve yoke	32.45	21.80	6.80	25.65	15.00	6
Push car wheels	6.00	10.50	3.05	2.94	7.50	4
Drill wrench	1.00	1.00	.00	1.26	.75	1
Prill chisel	15.00	2.18	.68	14.32	1.50	1
Driver brake nutmen	5.52	8.72	2.72	2.80	6.00	1
Wheel spools	1,276.80	113.08	35.08	1,241.72	78.00	15
Main rod blocks	15.88	28.34	6.84	7.04	19.50	9
Triple valve gages	20.00	3.27	1.02	18.98	2.25	1
Link blocks	7.24	51.49	15.49	56.75	36.00	20
Lift shafts	23.98	4.02	1.02	22.96	9.00	1
Quadrant	7.43	11.09	3.59	3.84	7.50	3
Wedges	55.04	69.69	21.69	33.35	48.00	25
Chafing castings	8.30	10.70	3.20	5.10	7.50	1
Plugging and building up holes	349.69	280.94	140.47	209.22	140.47	70
Tyre rim keys	3.22	5.38	2.38	.84	3.00	2
Flange stem	1.50	1.50	.00	1.16	.75	1
Reverse lever support	3.38	4.36	1.36	2.02	3.00	2
Smoke box	61.38	32.43	9.93	51.45	22.50	2
Hub livers	12.51	13.11	4.11	8.40	9.00	3
Strap on cross heads	25.37	31.00	12.66	12.66	18.34	3
Fire door handles	1.75	1.09	.34	1.41	.75	1
Boiler cranes	63.21	30.30	9.32	53.89	20.92	1
Frame buckle	5.52	2.41	1.29	3.99	1.50	1
Trailer yokes	5.25	6.45	1.95	3.30	4.50	1
Motion frame	9.10	10.17	4.17	4.93	6.00	1
Combination lever	1.03	1.75	.55	.48	1.20	1
Lugs on trailer hub	4.50	4.52	1.52	2.98	3.00	2
Center castings	76.81	28.56	9.06	67.75	19.50	3
Spring blocks	1.15	1.09	.34	.81	.75	1
Guide blocks	4.90	4.29	1.29	3.60	3.00	1
Steam pipes	5.19	13.10	4.10	1.09	9.00	2
Flat spots on tires	3.79	5.12	2.12	1.67	3.00	1
Cylinder bushings	59.86	95.77	29.77	70.09	66.00	4
Building up side rods	35.65	9.10	3.40	32.25	6.00	1
Grease cups	93.48	81.16	31.16	62.32	50.00	2
Cracks in tanks	11.79	11.43	3.93	7.86	7.50	5
Stationary fire doors	8.00	8.72	2.72	5.28	6.00	1
Cracks in flanges	372.69	113.62	35.72	337.53	78.46	14
Pitotant pipes	140.52	52.37	16.37	124.15	36.00	18
Filling worn spots	2,672.80	1,064.60	329.60	2,348.20	735.00	138
Pins	70.66	87.23	37.23	43.43	60.00	27
Reverse lever parts	103.02	74.04	23.04	79.98	51.00	38
Total	\$6,434.10	\$2,755.74	\$921.61	\$5,512.49	\$1,834.13	

Comparison of Electric Welding vs. Other Methods

Description of parts	Cost of other methods	Cost of elec. weld	Saving	No. engs.
Pedestals	\$645.00	\$45.24	\$599.76	5
Fault frames	9.03	1.36	7.67	1
Shop tools	34.36	3.40	30.96	4
Piston rods	165.00	16.37	148.63	10
Sharp flange brackets	165.00	3.28	161.72	3
Truck side	194.00	10.20	183.80	4
Building up dr. axles	121.50	4.90	116.60	1
Steel car underframe	11.34	1.71	9.63	1
Building up car axles	315.00	25.24	289.76	..
Bushing staybolt holes	204.96	73.74	321.22	36
Welding flanges	2,607.65	521.53	2,086.12	102
Frames	934.00	133.28	799.72	11
Cracks in fire boxes	2,431.27	297.17	2,134.10	92
Total	\$7,839.15	\$1,154.42	\$6,684.73	

Cost of other methods	Cost of gas welds	Cost of electric welds	Saving over other methods	Saving over gas weld
\$6,434.10	\$2,755.74	\$921.61	\$5,512.49	\$1,834.13
7,839.15	3,697.42*	1,154.42	6,684.73	2,540.00*
\$14,373.25	\$6,453.16	\$2,075.03	\$12,197.22	\$4,377.13

Costs and Savings Per Year

\$77,209.20	\$33,068.84	\$11,059.32	\$66,149.88	\$22,009.56
94,069.80	44,369.04*	13,853.04	80,216.76	30,516.00*
\$171,279.00	\$77,437.88	\$24,912.36	\$146,366.64	\$52,525.56

*Figures show cost of gas weld if work could have been welded with gas.

The connecting link between the engineering staff and the operators is the supervisor of welding, who is fully informed on the range of approved applications and is also the most expert operator on the road. He is continually traveling between the shops keeping the practice of each up to date and seeing that everything runs smoothly. The operators at local points are under the supervision of the foremen and master mechanics in exactly the same manner as lathe operators or other craftsmen.

It was found essential that we compile a complete set of welding instructions, which comprise some thirty typewritten pages. It is the purpose of this set of instructions to standardize the major operations as far as possible. The extreme range of the application of the process has made it quite impossible, up to the present time, to standardize every single operation, but these instructions cover the field in such a general way that the operator is prevented from making serious welding blunders.

The actual results of the operation of the welding equipment and the welding system on the Rock Island Lines have proven very interesting. We have recently undertaken a rather extensive investigation of what the results are, and I am giving below some of the figures we have obtained as a result of about six months' operation of the complete system. The real answer to the question of whether or not the expenditure of some \$40,000 for the installation of the system was justified lies in the actual facts—reduction of maintenance cost and actual gain in engine days with our present equipment. The following table shows some actual figures on the cost of repairing a small number of representative locomotive and other parts (for which we were able to obtain costs at a reasonable expenditure) by the gas and electric method, as compared with the old method, which in many cases involves a complete replacement of the part. As compared with the old method, the saving of the electric process arises principally in the saving in labor. As compared with the gas process, the electric welding offers a saving in cost of producing heat and an appreciable saving in cost of labor.

Our figures show that the saving effected by the electric arc welding system is being made at the rate of approximately \$200,000 a year with our present equipment. This figure includes a direct saving as compared with other methods of about \$136,000. The saving arising from the fact that we keep the engines in service a greater proportion of the time makes up the balance of the figure. Our figures show that this saving is being made at the rate of about 1,400 engine days per year.

Another way of looking at the same matter is that by the operation of the electric welding system we have obtained the service of four additional engines, without the additional investment, beyond that required to install the welding system. Four additional engines are worth approximately \$200,000. The welding system installed complete cost about \$40,000. The cost of operation of the system for a year is approximately \$34,000. Figuring the value of the engines at \$40 per day, we will pay for the operation of the whole electric welding system and will clear \$22,000 from this feature of the operation of the electric welding system alone. However, we made important savings, as are shown in the preceding table, in the repair of parts on engines, where we could not show an actual gain in engine days of service, and this saving amounts to more than twice the saving arising in the increase of the number of engine days of service we get from our equipment. The net return secured on the electric welder investment amounts to approximately 500 per cent per annum. The net cost of the installation and equipment per unit under present conditions is approximately \$1,300. The foregoing figures show rather conclusively that the installation of the electric welding system has been a profitable investment on the Rock Island Lines.

In spite of the fact that we have probably a larger number

of operators than any of the Western roads, we believe that we are far from fully equipped. The field of application of the process is continually widening. We are not able at the present time to handle all the operations which we have demonstrated to be practical and profitable. There is a totally unexplored field in maintenance of freight and passenger cars.

Within the last three years the arc welding process has been greatly improved and developed, both in the equipment for making the weld and in the welding material. It has, in fact, been developed to such a state that it will no doubt cause changes in many forms of construction, and the welding of fire boxes, tanks, etc., will become an economical practice. In the field of car construction and maintenance we may look for a wonderful development. For instance, today the cast steel truck side frame will last almost indefinitely where the electric welder is used in maintenance. By the intelligent application of spot welding with the electric arc, it will, no doubt, be possible to tie down bolts and nuts in the various parts of the rolling stock and motive power in such manner as to prevent their working loose, with the attendant very large saving in maintenance and operating expense. Quite recently we have been able, by using what is called a slag-coated electrode, to deposit steel having a carbon content of .50 per cent, which will enable us to do some work which we have been unable to do heretofore. We can successfully take care of the worn or damaged flanges of driving wheels, and should be able to reclaim much of the special work and rail steel by successfully building up the worn parts or broken sections.

It has been our purpose in establishing the practice in the welding field to look the facts squarely in the face and apply either the gas or electric process, depending on which shows the best results at the lowest price. At the present time we are of the opinion that the electric process will supersede the gas process on all steel welding and some of the rough steel cutting. In the cutting of boiler steel and all close cutting, however, and the welding of cast iron and the non-ferrous metals, the gas process has unequalled advantage. We are operating 75 gas torches and 1 acetylene generating plant on the same general principle as obtains in the case of the electric arc welding equipment. It is also best to use gas welders at all points where only occasional welding is done and which would not justify the investment necessary for the installation of an electric welder.

It is our belief that with approximately five times the amount of electric welding capacity we have at present, we can show at least five times the annual net saving, which would amount to a million dollars a year, and that we can with this equipment in operation show a saving of around 7,000 engine days per year, which means that we would be able to secure from our present engines a mileage that will equal that which could otherwise only be secured by the purchase of 23 additional engines.

DISCUSSION.

While many roads reported large savings by the use of oxy-acetylene welding only, a few had installed the arc welding process. The field for electric welding is even wider than for gas welding. Contrary to the opinion generally held, cast iron can be welded by the electric process with success. In judging the efficiency of welding, consideration should be given to the elasticity of the metal in the weld as well as the tensile strength. Welding can be done with thermit where other processes prove unsuccessful; for instance, the welding of main and side rods with thermit was practiced with entire success up to the time when the locomotive inspection law, forbidding autogenous welding of such parts, went into effect.

[Note.—The electric welding equipment of the Rock Island was described in the *Railway Mechanical Engineer* for June, page 307.—EDITOR.]



SIMPLEX CLASP BRAKE

A clasp brake adapted for use on either four-wheel or six-wheel passenger car trucks is being manufactured by the American Steel Foundries, Chicago. The design has been worked out with a view to providing a truck foundation brake gear that would perform its function in the most efficient manner without sacrificing simplicity, strength and economy of maintenance.

The brake rigging as applied to the truck consists of a

point of support at the center where a fulcrum jaw is fastened. This is connected to a swing hanger suspended from a spring steel bracket bolted to the truck frame. The brake beams in turn support the levers and thus all movement and support of the rigging is taken care of by swing hangers.

The adjustable brake heads, which are mounted on the trunnions, are of a special design to give the maximum space for changing shoes, at the same time affording ample clearance between the brake beams and the flanges of the wheels. Bearings for the release springs are fastened to the brake

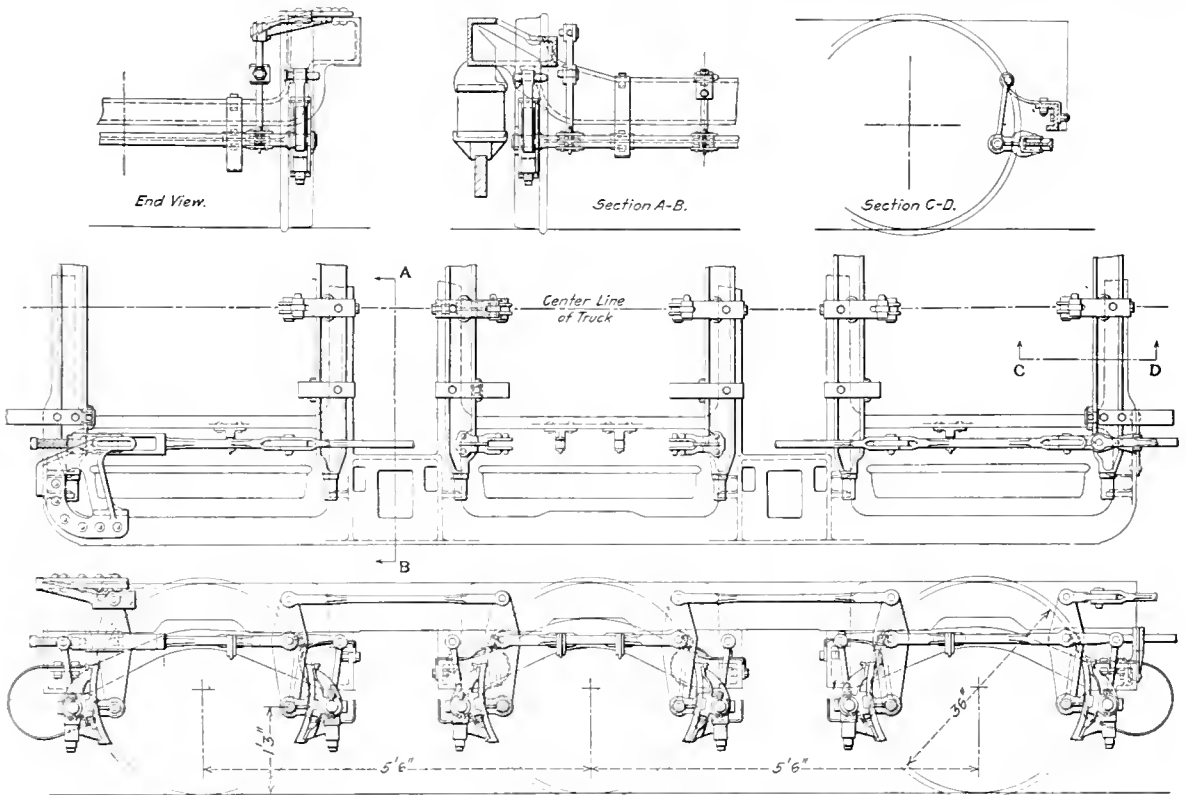

Arrangement of the Simplex Clasp Brake

double system of vertical levers just inside the wheels, connected to one another through pull rods and to the brake beams through fulcrum jaws. The brake beams, which are suspended close to the horizontal center line of the wheels, are straight drop forged members of an I-section, with cylindrical brake head trunnions at both ends. Brake hangers pivoted to the truck frame on both sides support the brake beams at the heads. The brake beams have a third

beams to prevent chafing of the beams. Adjusting screws are provided at the outer ends of the truck and give sufficient movement to adjust the entire rigging, which is necessary only when variations are made in the diameter of the wheels. All moving connections are case-hardened to keep the lost motion in the rigging to a minimum.

The type of construction used in the Simplex clasp brake produces an even distribution of forces on all shoes. Inertia

has been reduced by providing the most direct method of transmitting braking force and by keeping the weight of the parts as low as possible consistent with strength. Friction has been minimized by the swing hanger method of support. Since the rods all pass over some part of the truck it is practically impossible for any parts of the rigging to fall to the track. The design has been thoroughly tested by the American Steel Foundries and is in extensive use.

TYPE "B" RAGONNET REVERSE GEAR

On the accompanying drawing is shown the general arrangement of the "Type B" Ragonnet power reverse gear. This gear has recently been brought out by the Economy Devices Corporation, New York, and is a modification of

used in the older gear, has been retained and the method of lapping the valve and maintaining air pressure in the cylinder is the same in principle as that previously employed. The mechanical connections, however, have been entirely changed and the gear possesses a number of operating features impossible of attainment with the older design.

Starting at the cab, it will be seen that the lower end of the reverse lever is connected to the top of the combination lever, while the crosshead arm and the lower end of the combination lever are joined by a connecting rod. The valve is operated by a rocker extending out through the valve chest gland 19, the end of the outside rocker arm being attached to an intermediate pin connection in the combination lever. For any position in which the reverse lever may be latched, it will be seen that the valve is lapped when the piston has moved to a position in the cylinder corresponding to the position of the reverse lever. In this respect the operation of the "Type B" gear is the same as that of the previous type.

The construction of this gear is such, however, that the position of the reverse lever must always correspond within one or two notches to the position of the block in the link, irrespective of whether or not air pressure is available for the operation of the gear. This is brought about by extending the ends of the slide valve so that its movement in the valve chest is limited in either direction to the amount necessary to bring the cylinder port in line with the adjoining air admission port through the valve. A slight movement of the reverse lever causes the end of the valve to strike the end of the steam chest and prevents any further movement of the lever until the piston moves in the cylinder. The rocker arm connection 37 in effect becomes the fixed pivot, and the further movement of the reverse lever can only take place at a rate proportional to the movement of the piston in the cylinder. Should there be a tendency for the blocks to drop in the links when the engine is standing with the air pump shut off, excessive stresses might be set up in the parts of the gear if the valve and combination lever were

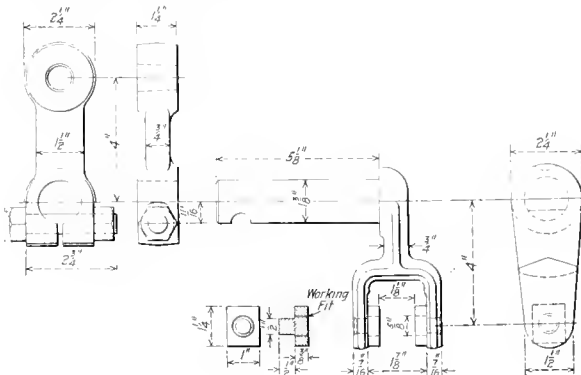

Details of the Valve Rocker and Connections

the well known Ragonnet reverse gear now in extensive service.

The most noticeable modification in the gear is the method

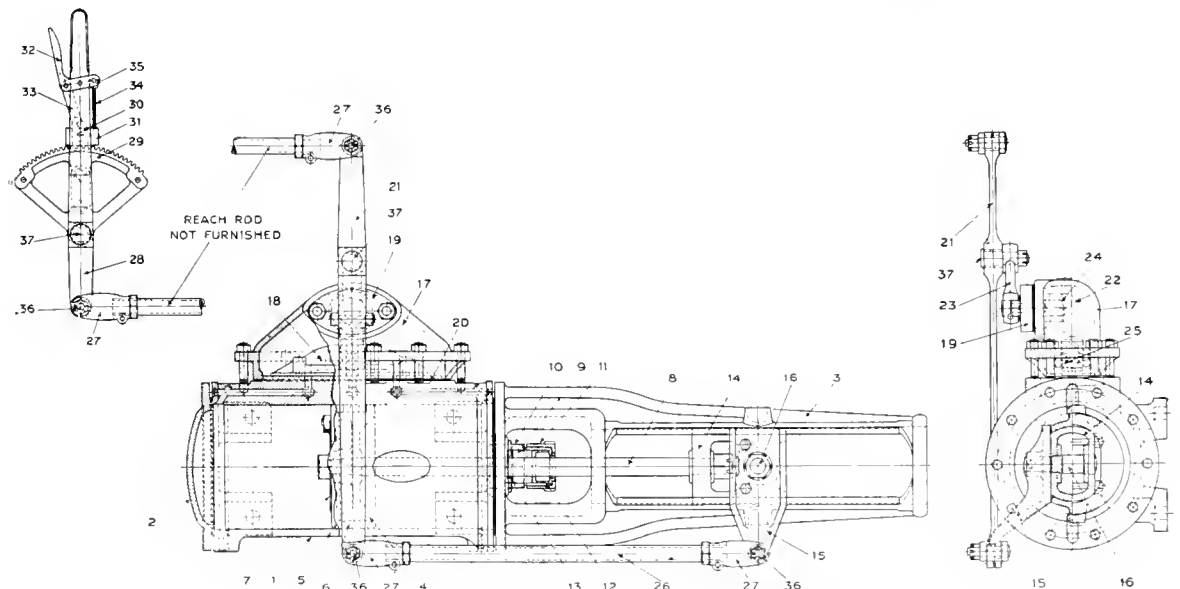

General Arrangement of the Type "B" Ragonnet Power Reverse Gear

by which the combination lever is connected to the slide valve, which materially decreases the length of the crosshead arm and raises the lower end of the combination lever so that there is practically no projection below the reverse gear cylinder. A slide valve, modified in detail from that

depended upon to resist this movement. In order to protect the gear under such conditions the reverse lever latch is so arranged that the force transmitted to the reverse lever lifts from the notches in the quadrant, thus permitting the lever to follow the movement of the link block to the corner.

When the valve chest is again under pressure, no movement of the gear is possible beyond the slight amount necessary to lap the valve until the reverse lever is moved.

In the construction of the cylinder and valve, cored passages have been entirely avoided, thus eliminating any possibility of trouble from coarse sand or scale at the valve seat. The increase in the length of the valve has materially added to the bearing surface and decreased the tendency toward uneven wear. Uniformity of wear is also insured by bringing the point of drive down close to the seat. The cylinder ports in the valve seat require an exhaust cavity in the valve but one-half inch in width and, therefore, the unbalanced area is so small that the valve always moves freely.

The parts inside the valve chest have been so arranged that there is nothing that can work loose or become displaced after they have once been assembled. The valve is moved by means of square blocks, which are placed on the inside of the jaws of the rocker, 22. These blocks work in vertical slots in the sides of the valve, and are pivoted about the ends of pins riveted in the rocker jaws. This construction will be made clear by reference to the drawing of the rocker. The rocker shaft is guided by the valve chest gland, 19, through which it has a working fit. This gland is made steam tight by the use of a ball joint ring, 24, which seats against the end of the gland, the flat face bearing against a shoulder on the rocker. The joints are sealed by the pressure in the valve chest.

The piston is packed with a special type of packing which has been developed especially for that purpose. Each ring is made up of a special rubber core which will not vulcanize under the saturated steam temperatures met with in locomotive practice, and which is not affected by oil. Outside of this core the ring is made up of a duck fabric arranged in vertical layers, so that the edges of the material form the wearing surface. Three of these rings are placed in each piston and are held in place by a follower plate, the edge of which bears directly against the packing. The guides are of the bored type, and are cast integral with the front cylinder head, thus making them self-centering.

A REMOVABLE DRIVING BOX HUB LINER

A removable hub liner for locomotive driving and engine truck boxes has been patented by J. T. Mallard, and its application is being handled by the Mallard Hub Liner Com-

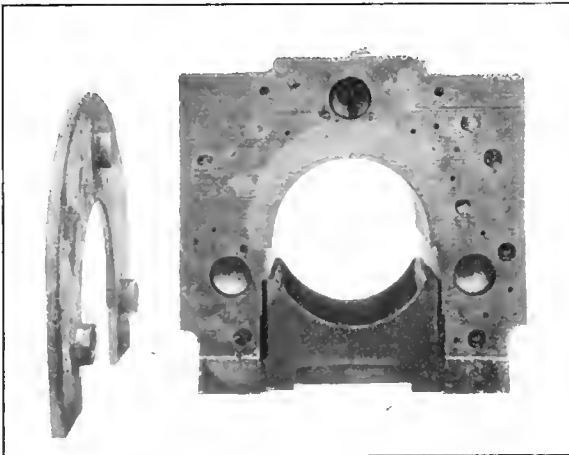

The Hub Liner Removed from the Box

pany, Newbern, N. C. This liner is made in two styles, one for use on roads where considerable curvature is encountered and the other for use where the line is compara-

tively straight. The illustration shows the application of the latter type.

As will be seen from the photograph, the brass hub liner is cast with three lugs of circular section on the back face, the diameters of which are $2\frac{1}{4}$ in. The face of the box is planed off to provide a bearing for the liner and holes are drilled at the proper locations to receive the lugs on the liner. A hole for a $\frac{1}{4}$ -in. pin is drilled in the top lug and a corresponding hole is drilled through the driving box cast-

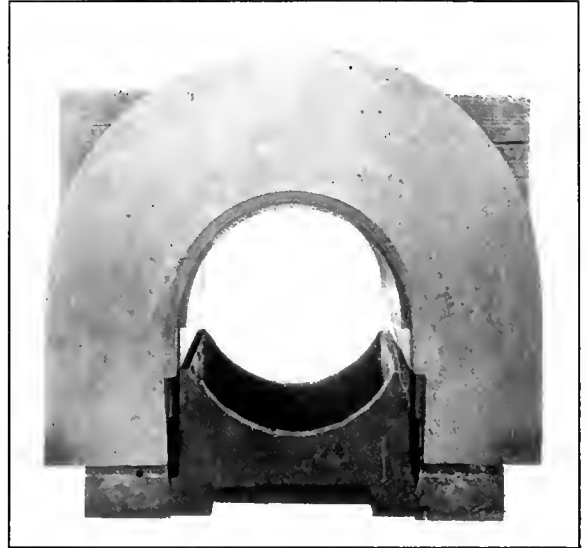

The Mallard Hub Liner

ing in order that the liner may be held in place by the use of a $\frac{1}{4}$ -in. pin.

The type of liner used where considerable curvature is encountered differs in the shape of the lugs which fit into the face of the driving box. These are oblong, the exact dimensions depending somewhat upon the design of the driving box. The upper lug is placed horizontally and ordinarily measures about $7\frac{1}{2}$ in. long by $1\frac{1}{2}$ in. wide, the ends being semi-circular in shape. The two side lugs are placed vertically and are about 4 in. long. The liner is secured to the box by two pins, one being placed through the top lug near each end.

It will be seen that the liner covers the entire face of the driving box, thus affording a bearing for practically the full area of the driving wheel hub. This is of advantage in that it distributes the wear over a larger area. After the first application of the Mallard liner, which should be made at the time the engine goes through the shop, the lateral may be taken up in from two to three hours for each pair of wheels. With liners poured on the face of the driving box, the taking up of lateral has always involved the shopping of the locomotive, it being necessary to take down the rods and drop the wheels in order to remove the driving boxes and apply new liners. With the removable liner it is only necessary to take down the pedestal binder, drop the shoe and wedge and move the box over against the pedestal. This allows sufficient clearance between the box and the wheel hub to remove the liner and replace it with a new one. It is not absolutely necessary that the liners be pinned to the boxes, as there is insufficient clearance between the face of the liner and the driving wheel hub with the shoe and wedge in place to permit the removal of the liner lugs from the pockets in the face of the box. Their use is desirable, however, to prevent undue pounding of the liner between box and hub.

ACORN DIE AND HOLDER

A die and holder has recently been developed by the Greenfield Tap & Die Corporation, Greenfield, Mass., which permits of adjustment without in any way impairing the accuracy of the lead. The die is also so designed that it may readily be removed from the holder and reground.

By referring to the dissembled view of the die holder, it will be seen that the die is secured to the holder by an adjusting cap which fits over the die and is threaded onto the body of the holder. The cap is provided with holes in the walls to permit the exit of chips which may collect inside the base of the die. The adjusting cap is secured to the body in any desired position by a nut lock. The nose of each die is

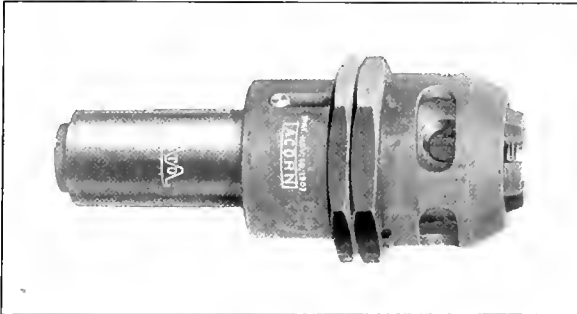

The Acorn Die and Holder Assembled

beveled to an angle corresponding to that on the inside cone of the adjusting cap. Both beveled surfaces are ground, thus assuring perfect contact and accuracy of adjustment. The radial adjustment of the lands is accomplished by turning the adjusting cap on the thread of the body, the bevel on the inside of the cap exerting a uniform pressure upon all the lands and drawing them together to whatever diameter may be required. It is evident that the lands are moved radially and that their angular spacing is unaffected by the adjustment, a condition which does not hold for either the round split die or dies in which the prongs are held in a split ring. The tracking of the lands, therefore, always remains perfect.

The body, the stem of which is inserted in the shank, is

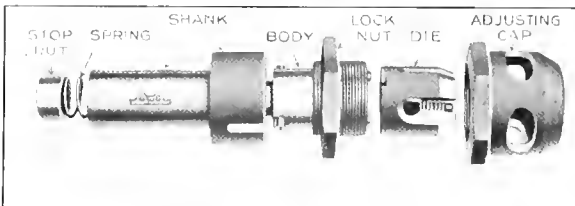

Dissembled View of the Acorn Die Holder

of ample dimensions to provide for any operating strain that may be brought to bear upon it. The body is driven by means of a cross pin which fits into the slot in the shank. The body is not held rigidly in the shank, but is permitted a certain degree of lateral slide or "float."

The lands of the Acorn die are somewhat similar to those of a spring die, but are shorter and wider. Their strength is such that there is no tendency for them to twist. The use of a special alloy steel in their manufacture permits their successful hardening without distortion. In order to facilitate the necessary radial movement of the lands, the section immediately back of the thread is reduced in thickness. The lands are of uniform strength, however, owing to the

increased width at the base; this prevents any tendency toward torsional displacement.

Notches in the base of the die register with dowels on the body, thus securing a positive drive. The base of the die and its seat on the body are accurately ground to a flat surface, which insures absolute alinement when changing the dies or replacing them after sharpening. The opening between the lands facilitates the grinding the dies, which may

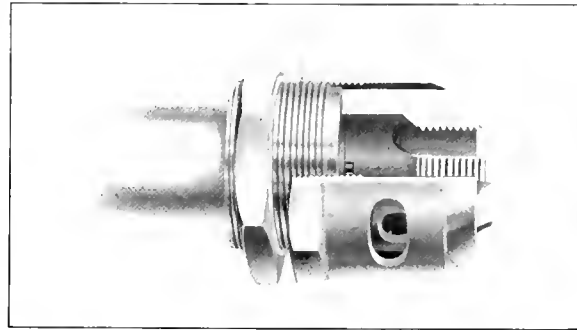

Sectional View of the Die and Adjusting Cap

be done by hand or by machine, in a special holder.

The illustrations show the regular Acorn die holder, but releasing holders or adapters, by means of which the Acorn dies may be used in machines or holders already in operation, may be supplied.

CAST STEEL PILOT AND ASH PAN

Among its several products the Commonwealth Steel Company, St. Louis, Mo., has had in successful service cast steel pilots and ash pans. The pilot is shown in Fig. 1. It can be quickly applied, removed, raised or lowered, one means provided for raising or lowering it being a rack. This construction permits the alteration in height to be attained in a few minutes. These racks on the backs of the pilots are

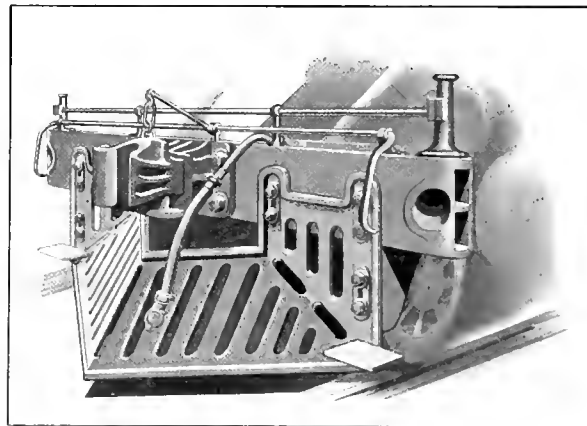

Fig. 1—Commonwealth Cast Steel Pilot

made to fit corresponding racks on the pilot beams, or on separate brackets fastened to the pilot beams.

These adjustable pilots are cast in one piece and can readily be made to meet the requirements of new or old locomotives. They are strong, simple and durable, requiring practically no repairs, and in time make quite a saving in maintenance cost, as compared with other types. They are easily repaired when bent in case of wreck. One of the designs embraces the requirements for both road and switch

engines, a long step being placed at either side to meet switch engine requirements when a road engine is used in yard switching. They meet all Government requirements.

The cast steel ash pan is shown in Fig. 2. It is made for single and double hoppers. These ash pans do away with the frequent expensive renewals and repairs characteristic of other types, as they are so designed that they do not burn out. They also prevent live coals from scattering on the roadway and causing fires. As these pans do not warp,



Fig. 2—Commonwealth Cast Steel Ash Pan

a tight door is maintained that retains the coals. They are made up of but a few parts and have that advantage over the built-up types. This type of pan will last a long time and greatly reduces the maintenance costs for this particular part of the locomotive.

TRUCK LEVER TYPE SLACK ADJUSTER FOR FREIGHT CARS

In the June 14, 1916, issue of the *Daily Railway Age Gazette*, page 1263, there appears a description of an automatic slack adjuster for freight cars which was developed by the Gould Coupler Company, New York. This slack adjuster replaced the push rod in the truck brake rigging, performing the functions of the latter, as well as that of the slack adjuster. The function of the push rod was performed by two members, one of which telescoped within the other. In the barrel, or hollow member, was a pocket containing

a friction sleeve operating between two lugs on the side of the barrel member of the slack adjuster, automatically caused the lengthening of the push rod members on the release of the brakes to maintain a constant clearance between the brake shoes and the wheels.

The drawing shows the application of the same principle in a device, since developed by the Gould Coupler Company, which has been materially altered and much simplified in construction. The slack adjuster proper is attached directly to the lower end of the live lever and through it passes the push rod which in this case is in one piece. The friction

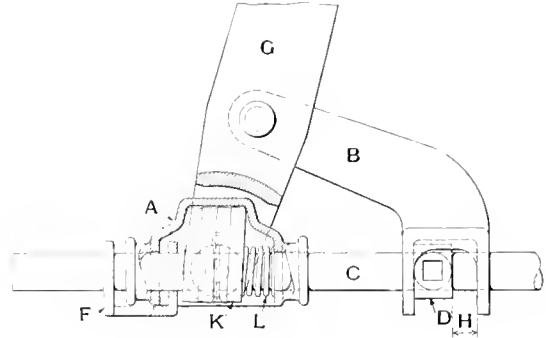

Details of the Slack Adjuster

sleeve is mounted directly on the push rod and the adjusting rod employed in the original device has been replaced by an adjusting bracket attached to the live lever at the same location, but provided with a housing at the other end which slides on the push rod and contains the friction clamp.

The operation of the slack adjuster may be made clear by referring to the sectional drawing showing the arrangement of the details. It will be seen that the slack adjuster body A, containing four clamping dogs K is mounted on the push rod C, the lower end of the live lever G being connected directly to the body A. The spring L normally holds the dogs K in an oblique position in which they grip the push rod and prevent any movement of the adjuster along the rod toward the right. The friction clamp D may be

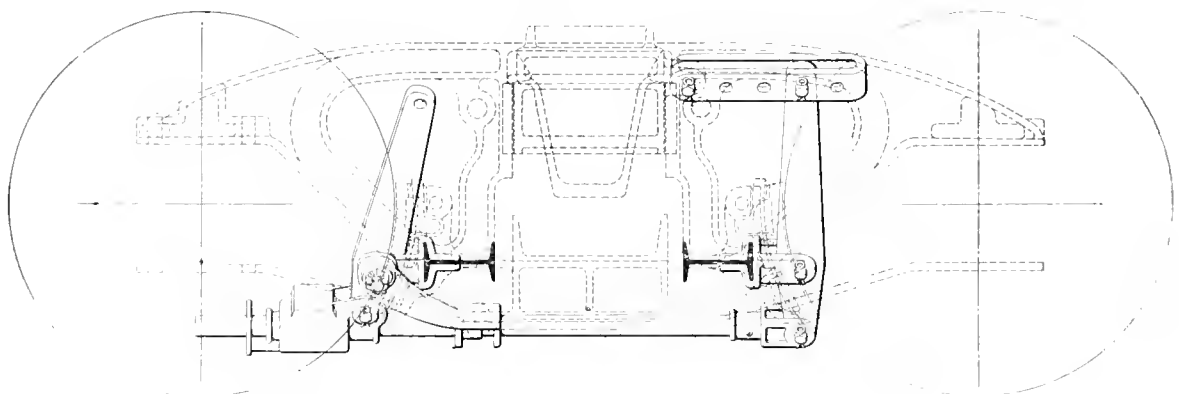

Universal Truck Lever Type Automatic Slack Adjuster

two friction grip dogs through which passed the solid, or push rod member, the normal position of the dogs at an angle of four or five degrees from a line at right angles to the center line of the push rod preventing the latter from telescoping, but permitting its movement freely in the other direction to lengthen the connection between the lower ends of the live and dead levers. An adjusting rod attached to the brake beam fulcrum pin of the live lever, provided with

moved along the push rod, but considerable pressure is required to move it.

The device as shown in the drawing is in release position. An application of the brake causes the upper end of live lever G to move to the left, carrying with it its brake beam and brake shoes until the latter bear against the wheel treads. Further movement then causes the push rod C to be moved to the right, applying the brake shoes to the other

pair of wheels. The distance *H* between the friction clamp and the right hand shoulder of the adjusting bracket *B* is just sufficient to permit the angular movement of the live lever relative to the push rod required to take up the normal amount of clearance between the brake shoes and the wheel treads.

Any increase in this clearance due to brake shoe wear causes the shoulder of the adjusting bracket to move the friction clamp along the push rod toward the left. On the release of the brake, the parts again assume the position shown in the drawing, the left hand shoulder of the adjusting bracket striking the friction clamp *D* and, if the latter has been moved to the left in the preceding brake application, causing the push rod *C* to move to the right through the slack adjuster jaw by the same amount. The slack will thus be taken up and only a normal amount of movement of the parts will take place at the next application of the air brake.

When the brake shoes are renewed it becomes necessary to let out the slack. To do this, the release handle *F* is first moved to the right, thus unlocking the dogs *K* and permitting the push rod *C* to move to the left. The friction clamp *D* is forced to the right until it strikes the right hand jaw of the adjusting bracket, this operation being repeated until the brake beams are far enough off the wheel to renew the brake shoes. The proper adjustment of brake shoe clearance will automatically be effected on the first application of the brake.

MASON GREASE CUP PLUG

A new form of grease cup plug which is being used with good results is shown below. As will be seen by referring to the illustration, the plug is so constructed that it is securely held even though it is screwed in but a short distance.

The design is particularly effective when used with an internally threaded grease cup. It frequently happens that after grease cups are freshly filled, the plugs cannot be screwed into the cups more than three or four turns, which does not furnish a sufficient engagement for the plug and it is dislodged by vibration. It is claimed that with

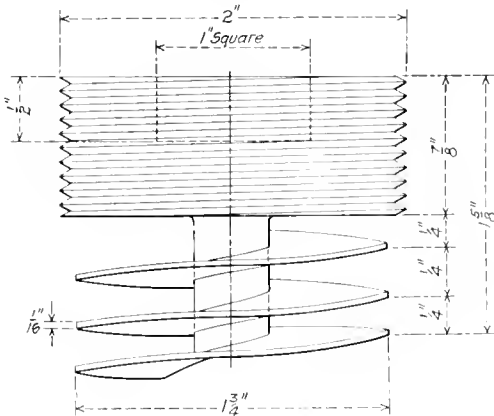

Mason Grease Cup Plug

this type of plug dislodgment is prevented by reason of the fact that when the cup is filled with grease and the plug screwed into place a certain amount of the grease is forced around the screw blade, holding the plug in position. This device has been adopted after extensive tests by one of the large western roads. The plug has been patented by the inventor, Fred Mason, Pittsburg, Kan.

ARCH TUBE CLEANER

The arch tube cleaner shown in the illustration has been patented by R. M. Clark, foreman of the Nashville, Chattanooga & St. Louis, and has been used on that road with considerable success. This tool is made of substantial material and is composed of a hollow spindle and eight round

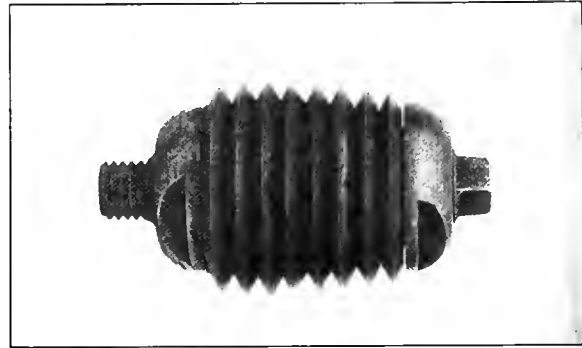

Tool for Cleaning Arch Tubes

cutters. The cutters are made of steel and are tempered hard. The tool is lubricated with hard grease and is ready for service at all times. It can be attached to any turbine motor and will remove the hard scale from arch tubes or any kind of tubes successfully.

HUNTOON TRUCK BOLSTER

The Joliet Railway Supply Company, Chicago, has placed on the market a new type of truck bolster known as the Huntoon bolster. It is of the built-up type and embodies the same principles of reinforcing of the tension member that is used in the tension member of the Huntoon brake beam.

Both the compression and the tension members are of open hearth steel, the compression member being a channel and the tension member a flat bar upset at the ends to retain the full cross sectional area at the rivet holes. The ends of the tension member are provided with shoulders which interlock with the web and flanges of the compression member, thus relieving the shearing strain on the rivets

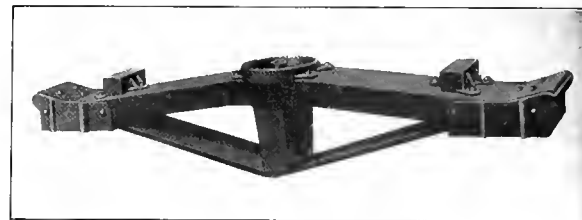

New Type of Built up Bolster

The king post is of malleable iron of heavy cross section. The center plates can be furnished of malleable iron, cast steel or drop forged, as desired. The bolster is adapted to the application of either plain or anti-friction type side bearings.

Tests have demonstrated that this type of construction produces a bolster of great rigidity and strength. Sizes for 30, 40, 50 and 70-ton cars are now being manufactured and the company is prepared to furnish them in any quantities desired.

Railway Mechanical Engineer

(Formerly the RAILWAY AGE GAZETTE, MECHANICAL EDITION
with which the AMERICAN ENGINEER was incorporated)

PUBLISHED ON THE FIRST THURSDAY OF EVERY MONTH BY THE
SIMMONS-BOARDMAN PUBLISHING COMPANY

EDWARD A. SIMMONS, *President* L. B. SHERMAN, *Vice-President*
HENRY LEE, *Vice-President and Treasurer* M. H. WILM, *Secretary*
WOOLWORTH BUILDING, NEW YORK, N. Y.
F. H. THOMPSON, *Business Manager, CHICAGO.*

Chicago: Transportation Bldg. Cleveland: Citizens' Bldg.
Washington: Home Life Bldg.
London: Queen Anne's Chambers, Westminster.

ROY V. WRIGHT, *Editor*
R. E. THAYER, *Managing Editor*
C. B. PECK, *Associate Editor* A. F. STUEBING, *Associate Editor*

Entered at the Post Office at New York, N. Y., as mail matter of the second class

Subscriptions, including the eight daily editions of the *Railway Age Gazette* published in June in connection with the annual conventions of the Master Car Builders' and American Railway Master Mechanics' Associations, payable in advance and postage free: United States, Canada and Mexico, \$2.00 a year; Foreign Countries (excepting daily editions), \$3.00 a year; Single Copy, 20 cents.

WE GUARANTEE that of this issue 10,000 copies were printed; that of these 10,000 copies 7,861 were mailed to regular paid subscribers, 110 were provided for counter and news companies' sales, 311 were mailed to advertisers, 190 were mailed to exchanges and correspondents, and 1,528 were provided for new subscriptions, samples, copies lost in the mail and office use; that the total copies printed this year to date were 92,347, an average of 9,234 copies a month.

THE RAILWAY MECHANICAL ENGINEER is a member of the Associated Business Papers (A. B. P.) and the Audit Bureau of Circulations (A. B. C.).

A roundhouse of the Delaware, Lackawanna & Western at Scranton, Pa., was damaged by fire September 13, and 14 locomotives were seriously damaged.

The Delaware & Hudson has made a general increase in the pay of shopmen; said to be, for mechanics, from 45 cents an hour to 50 cents, and for helpers from 30 cents an hour to 33½ cents.

The State College of Pennsylvania announces special correspondence courses in elementary engineering subjects, established to meet the unusual demand for men in shops and manufacturing plants.

A strike of shopmen of the Kansas City, Mexico & Orient was settled through mediation on September 14, following conferences between committees representing the shop crafts and officers of the road. The men had asked for a 10-cent increase in wages, and were offered an increase of two and one-half cents an hour by the company. The compromise agreement, which was reached on September 14, provides for an increase of from three to six cents an hour for mechanics, helpers and car-men, and two and one-half cents for apprentices. The men had been off work for nine days.

According to advices received by the Texas Railroad Commission, there is such a shortage of expert mechanics that the Southern Pacific and the Santa Fe are meeting delay in changing the fuel equipment of their locomotives from oil burners to coal burners. The purpose of going back to the use of coal is in order to conserve the crude oil supply for war purposes. The demand for mechanics is said to be the greatest ever known in the history of Texas. Thousands of these skilled artisans have left the state during the last sev-

eral months to take employment in industrial plants in the North and East. The railroad shops have been largely depleted of this class of employees, and there is no source open by which to fill the existing demand for them.

Recruiting officers in several of the large cities of the country are advertising for recruits for five additional engineer regiments, one of which, the 21st Engineers, will be for constructing light railroads. The remaining four include the 20th, forestry; the 23rd, highway; 25th, construction, and the 26th, supply and water supply. For the 21st, the light railway, men trained in the following trades are wanted: Timbermen, bridge carpenters, masons, pipefitters, steamfitters, hoisting engineers, firemen, dinkey runners, teamsters, track layers, construction foremen, pile drivers, concrete foremen, telegraph linemen, riggers, cooks, machinists, blacksmiths, transitmen, surveyors, draftsmen, storekeepers, machine repairers, clerks, electricians, oilers, painters, rod drillers, powdermen, signal installers and bridgemen.

The Missouri, Kansas & Texas management recently came to an understanding with its shopmen with reference to wage increases. The terms of settlement with the men included a flat increase of 6½ cents an hour to machinists, boilermakers, blacksmiths, sheet metal workers and electricians, and to the helpers in the different trades and helper apprentices. Regular apprentices were granted an advance of 2½ cents an hour. The increases make the standard rate of pay for machinists, boilermakers, blacksmiths, sheet metal workers and shop electricians for points north of Muskogee, Okla., 50 cents an hour; for Muskogee and points south, including Oklahoma City and McAlester

RAILROAD CLUB MEETINGS

Club	Next Meeting	Title of Paper	Author	Secretary	Address
Canadian	Oct. 9	Locomotive Design and Construction from a Maintenance Standpoint	W. H. Winterrowd	James Powell	P. O. Box 7, St. Lambert, Que.
Central	Nov. 9	The Handling of Scrap, Etc.	J. P. Murphy	Harry D. Vought	95 Liberty St., New York
Cincinnati	Nov. 13			H. Boulet	191 Carew Bldg., Cincinnati, O.
New England	Oct. 9	The Freight Car—A Factor in Winning the War	E. H. De Groot	W. E. Cade, Jr.	683 Atlantic Ave., Boston, Mass.
New York	Oct. 19	Conservation of Material	M. K. Barnum	Harry D. Vought	95 Liberty St., New York
Pittsburgh	Oct. 26	Annual Meeting, Smoker and Entertainment		J. B. Anderson	Room 207, P.R.R. Sta., Pittsburgh, Pa.
Richmond	Oct. 8	The Ability of Refrigerator Cars to Carry Perishable Freight	Dr. M. E. Pennington	F. O. Robinson	C. & O. Railway, Richmond, Va.
St. Louis	Oct. 12			B. W. Brauenthal	Union Station, St. Louis, Mo.
South'n & S'w'n	Nov. 15			A. I. Merrill	Grand Building, Atlanta, Ga.
Western	Oct. 15			F. W. Taylor	1112 Karpen Bldg., Chicago.

PERSONAL MENTION

and all points in Texas, 51 cents an hour, and on the Wichita Falls & Northwestern, 52 cents an hour. Machinists, steel metal workers and electrician helpers will receive 30½ cents an hour at all points on the system and boilermaker and blacksmith helpers 33 cents an hour.

Headlight Order Again Modified

The Interstate Commerce Commission has announced a further modification of its locomotive inspection rules, postponing from July 1 to January 1, 1918, the effective date of the requirement that new locomotives shall be equipped with electric headlights, and providing that for locomotives in service prior to that date the changes shall be made the first time they are shopped for general repairs after that date. All locomotives are required to be equipped by July

Strike of B. & M. Shopmen

The machinists, blacksmiths and boiler makers of the Boston & Maine struck on August 31, and all the locomotive repair shops, general and division, stopped work, about 3,300 men going out. Nearly half of these men were employed at the shops at Billerica, Mass. Conferences concerning the requests of the men for higher pay have been held a number of times since last April, when an increase of about two cents an hour was granted and was made retroactive from January 1, 1917. In July the men asked for a further increase of eight cents an hour. The New Haven road has recently granted an increase and the receiver of the Boston & Maine offered to make the pay on the B. & M. equal to that on the New Haven, but this was refused. The increase on the New Haven, three cents an hour, brought the rates up to a point a little in excess of the rates on the Boston & Maine. An agreement was reached on September 8 at a conference between the strikers, the railroad officers and the Massachusetts Committee on Public Safety, and the 3,300 men involved are now back in the shops.

Both the union and the railroad agreed that the wages be raised five cents an hour, provided the men return to work at once. The men asked for eight cents an hour, and the remaining three cents will be submitted to an arbitration for decision. Henry B. Endicott, executive manager of the Public Safety Committee, was chosen the sole arbitrator.

MEETINGS AND CONVENTIONS

The following list gives names of secretaries, dates of next or regular meetings and places of meeting of mechanical associations:

- AIR BRAKE ASSOCIATION.**—F. M. Nellis, Room 3014, 165 Broadway, New York City.
- AMERICAN RAILROAD MASTER TINNERS', COPPERSMITHS' AND PIPEFITTERS' ASSOCIATION.**—O. E. Schlink, 485 W. Fifth St., Peru, Ind. Convention postponed.
- AMERICAN RAILWAY MASTER MECHANICS' ASSOCIATION.**—J. W. Taylor, Karpen Bldg., Chicago. Convention postponed.
- AMERICAN RAILWAY TOOL FOREMEN'S ASSOCIATION.**—R. D. Fletcher, Belt Railway, Chicago. Convention postponed.
- AMERICAN SOCIETY FOR TESTING MATERIALS.**—Prof. E. Marburg, University of Pennsylvania, Philadelphia, Pa.
- AMERICAN SOCIETY OF MECHANICAL ENGINEERS.**—Calvin W. Rice, 29 W. Thirty-ninth St., New York.
- ASSOCIATION OF RAILWAY ELECTRICAL ENGINEERS.**—Joseph A. Andreuccetti, C. & N. W., Room 411, C. & N. W. Station, Chicago.
- CAR FOREMEN'S ASSOCIATION OF CHICAGO.**—Aron Kline, 841 Lawlor Ave., Chicago. Second Monday in month, except June, July and August, Hotel Morrison, Chicago.
- CHIEF INTERCHANGE CAR INSPECTORS' AND CAR FOREMEN'S ASSOCIATION.**—W. R. McMunn, New York Central, Albany, N. Y. Convention postponed.
- INTERNATIONAL RAILROAD MASTER BLACKSMITHS' ASSOCIATION.**—A. L. Woodworth, C. H. & D. Lima, Ohio. Convention postponed.
- INTERNATIONAL RAILWAY FUEL ASSOCIATION.**—J. G. Crawford, 547 W. Jackson Blvd., Chicago.
- INTERNATIONAL RAILWAY GENERAL FOREMEN'S ASSOCIATION.**—William Hall, 1126 W. Broadway, Winona, Minn. Convention postponed.
- MASTER BOILERMAKERS' ASSOCIATION.**—Harry D. Vought, 95 Liberty St., New York. Convention postponed.
- MASTER CAR BUILDERS' ASSOCIATION.**—J. W. Taylor, Karpen Bldg., Chicago. Convention postponed.
- MASTER CAR AND LOCOMOTIVE PAINTERS' ASSOCIATION OF U. S. AND CANADA.**—A. P. Darc, B. & M., Reading, Mass. Convention postponed.
- NIAGARA FRONTIER CAR MEN'S ASSOCIATION.**—E. N. Frankenberger, 623 Brisbane Bldg., Buffalo, N. Y. Meetings, third Wednesday in month, New York Telephone Bldg., Buffalo, N. Y.
- RAILWAY STOREKEEPERS' ASSOCIATION.**—J. P. Murphy, Box C, Collinwood, Ohio. Convention postponed.
- TRAVELING ENGINEERS' ASSOCIATION.**—W. O. Thompson, N. Y. C. R. R., Cleveland, Ohio.

GENERAL

W. L. BEAN, whose appointment as assistant to the general mechanical superintendent of the New York, New Haven & Hartford, was announced in these columns last month, was



W. L. Bean

born on January 3, 1878, at Stevens Point, Wis., and graduated from the University of Minnesota with the degree of mechanical engineer in 1902. The same year he began railway work with the Northern Pacific as special apprentice. In December, 1904, he went to the Atchison, Topeka & Santa Fe, serving successively as erecting shop foreman, locomotive inspector at the Baldwin Locomotive Works in Philadelphia, and machine shop foreman at La Junta,

Colo. In January, 1909, he was appointed division foreman at Belen, N. M., and the following July was appointed motive power assistant at Topeka, Kan. On February 1, 1912, he became chief engineer for the Oswald Railroad Service Company, at Chicago, and on July 10, 1916, he entered the service of the New Haven in the capacity of assistant to the president.

WILLIAM H. BRADLEY, who has been appointed assistant to the general superintendent of motive power of the Chicago & North Western, with headquarters at Chicago, as announced in the *Railway Mechanical Engineer* for September, was born in May, 1869, at Momence, Ill. He was educated in the Chicago public schools and began work with the Chicago & North Western on December 1, 1885, as machinist helper.



W. H. Bradley

From June 6, 1886, to November 29, 1891, he was a fireman, then becoming an engine-man, and in January, 1903, a road foreman of engines. He was promoted to assistant master mechanic of the Iowa division in August, 1907, and in September, 1908, was made master mechanic of the Madison division. In October, 1909, he was transferred to the Iowa division as master mechanic.

H. C. EICH, master mechanic at the Burnside, Chicago, shops of the Illinois Central, has been appointed superintendent of motive power of the Chicago Great Western, with headquarters at Oelwein, Iowa, succeeding G. M. Crownover, resigned.

H. C. EICH, master mechanic at the Burnside, Chicago, shops of the Illinois Central, has been appointed superintendent of motive power of the Chicago Great Western, with headquarters at Oelwein, Iowa, succeeding G. M. Crownover, resigned.

WILLIAM H. FETNER, general master mechanic of the Central of Georgia at Savannah, Ga., has been appointed acting superintendent of motive power, during the leave of absence of F. F. Gaines.

J. H. FULMOR, master mechanic of the Pennsylvania Railroad at Mt. Carbon, Pa., has been assigned to duty on the staff of the superintendent of motive power, Eastern Pennsylvania division, as inspector, with office at Altoona, Pa. Mr. Fulmor was born in 1874 and received his education in the public schools. On June 9, 1891, he became an apprentice with the Pennsylvania Railroad and on July 1, 1895, was made machinist. On January 16, 1899, he was advanced to acting road foreman of engines and was made master mechanic at Mt. Carbon, Pa., on April 1, 1905.

F. F. GAINES, superintendent of motive power of the Central of Georgia at Savannah, Ga., has been granted a leave of absence on account of illness.

F. N. HIBBITS, who resigned as superintendent of motive power of the Lehigh Valley in 1915, to go to the Baldwin Locomotive Works as assistant general superintendent, has returned to the service of the Lehigh Valley, as superintendent of motive power, succeeding H. C. May, resigned.

L. S. KINNAIRD, master mechanic on the Pennsylvania Lines at Logansport, Ind., has been appointed superintendent of motive power of the Chicago & Eastern Illinois, with headquarters at Danville, Ill., succeeding J. E. Epler, resigned.

PAUL L. GROVE, master mechanic of the Philadelphia Terminal division of the Pennsylvania Railroad, has been appointed superintendent of the Delaware division of the Philadelphia, Baltimore & Washington,

with office at Wilmington, Del. Mr. Grove was born on October 3, 1878, at Altoona, Pa., and was educated in the public schools of that city. From May 1, 1894, to December 1, 1899, he was employed by the Pennsylvania Railroad as messenger and machinist apprentice in the Altoona shops. On February 1, 1902, he was transferred to the shops at Columbia, Pa., as inspector, and in October, 1904, became shop foreman on the Bedford division. He was promoted to assistant master mechanic of the Altoona machine shops on July 1, 1905, and was made assistant engineer of motive power on the Buffalo division in September, 1910. He was promoted on December 1, 1913, to master mechanic on the Williamsport division; in October, 1914, he was transferred to the Renovo division, and on July 1, 1916, he was again transferred to the Philadelphia Terminal division, in charge of the West Philadelphia shops, and now becomes superintendent of the Delaware division.

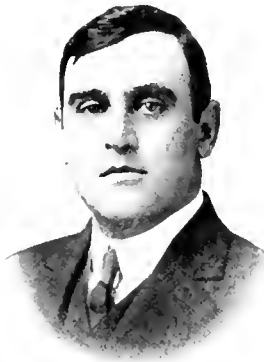

P. L. Grove

was then machinist for three years at the same place. In 1899 he became a student in the Mechanical Engineering School of Purdue University at La Fayette, Ind., from which he graduated in 1902. He was then appointed master mechanic on the Cleveland, Cincinnati, Chicago & St. Louis at Louisville, Ky., remaining in that position until 1907. From 1907 to 1910 he served on the Louisville & Nashville as master mechanic at New Decatur, Ala., and at South Louisville, Ky., and from 1910 to about January, 1916, when he went to the Lehigh Valley, he was superintendent of motive power of the Chicago, Indianapolis & Louisville. He now returns to that road to serve in the same capacity.

G. O. HAMMOND, who has been appointed general mechanical superintendent of the New York, New Haven & Hartford with headquarters at New Haven, Conn., as has



G. O. Hammond

already been announced in these columns, was born on April 20, 1874, in New York City. He graduated from the New York public schools and from Stevens Institute of Technology, where he received the degree of mechanical engineer. In November, 1898, he began railway work as a special machinist at the Susquehanna shops of the Erie Railroad. He subsequently served as special apprentice until December, 1899; then as draftsman to 1901, and during the following year served as engineering clerk. He was general foreman of the Meadville shops until 1903, and later served as machinery inspector until 1905, and as chief draftsman from January to July, 1905, when he became mechanical engineer. He subsequently served as assistant mechanical superintendent and assistant to general mechanical superintendent until January, 1909, when he became mechanical engineer for the New York Air Brake Company. From February, to April, 1913, he acted as assistant superintendent on the New York, New Haven & Hartford. From May, 1913, to May, 1917, he was assistant mechanical superintendent and then was appointed assistant general mechanical superintendent, which position he held until his recent appointment as general mechanical superintendent.

R. J. WILLIAMS has been appointed superintendent of motive power on the Pere Marquette, with headquarters at Detroit, Mich., succeeding W. L. Kellogg, resigned.

FRANCIS M. WARING, acting engineer of tests of the Pennsylvania Railroad at Altoona, Pa., has been appointed engineer of tests. Mr. Waring was born on September 28, 1879, at Charleston, S. C., and is a graduate of the Charleston High School and Virginia Polytechnic Institute. He began railway work with the Northern Central at Baltimore, Md., on November 14, 1898. On March 5, 1900, he entered the employ of the Pennsylvania Railroad, on special duty at Williamsport, Pa. On November 1, 1901, he was transferred to Baltimore on special duty and subsequently served there as a machinist until July 17, 1902, when he again returned to Williamsport to be assigned to special work. On November 1, 1902, he became a draft-man there, and on October 19, 1903, was made an inspector at Altoona. He entered the test department on September 11, 1912, as foreman of the physical laboratory, and from June 1, 1917, until

he received his recent appointment, he has been acting engineer of tests.

JAMES YOUNG, JR., assistant master mechanic of the Philadelphia, Baltimore & Washington at Wilmington, Del., has been appointed assistant engineer of motive power of the New Jersey division of the Pennsylvania Railroad, with headquarters at New York, succeeding James B. Diven. Mr. Young was born on May 25, 1885, and graduated from Purdue University in 1907. His first railroad work was performed as an apprentice in the summer of 1902. On June 19, 1907, following his graduation, he became a special apprentice in the Altoona, Pa., shops. He was advanced to inspector in the Altoona machine shop on June 27, 1909, to assistant storekeeper on November 15 of the same year, and on December 16, 1909, was appointed inspector on the New Jersey division. He was made assistant engine house foreman at West Morrisville, Pa., on November 1, 1910, and from February 5, 1917, to September 1, 1917, when he received his latest appointment, he was assistant master mechanic at Wilmington, Del.

W. H. SAMPLE, master mechanic of the Grand Trunk at Montreal, Que., has been appointed superintendent of motive power, with headquarters at Montreal, Quebec.

Mr. Sample was born in 1864, at Altona, N. Y., and was educated at the high school of his native town. He began railway work in 1882, as fireman on the Central Vermont, and in 1886 was promoted to engineman. From 1887 to 1890, he served on the Santa Fe System as engineman, and then returned to the Central Vermont. In 1901 he was appointed road foreman of engines, remaining in that position until 1906. He then entered the service of the United Fruit Company

as superintendent of motive power and car departments on the Northern Central Railway of Costa Rica, Central America, resigning from that position in 1911 to go to the Grand Trunk as master mechanic on the Ottawa division. He was transferred as master mechanic to the western lines in 1914, and in 1916 was again transferred in the same capacity to the eastern lines.

MASTER MECHANICS AND ROAD FOREMEN OF ENGINES

C. W. BURKET has been appointed assistant master mechanic of the Monongahela division of the Pennsylvania Railroad with office at South Pittsburgh, Pa., succeeding E. H. Newbury.

A. W. BYRON, master mechanic of the New York, Philadelphia & Norfolk at Cape Charles, Va., has been furloughed from railroad service to enter the Officers' Training Camp at Fort Oglethorpe, Ga.

A. McDONALD, foreman of the erecting shop of the Grand Trunk at Stratford, Ont., has been appointed assistant master mechanic, with headquarters at the Montreal shops.

B. H. DAVIS, assistant master mechanic of the Delaware, Lackawanna & Western at Scranton, Pa., has been appointed master mechanic of the Scranton, Syracuse & Utica and Bangor & Portland divisions, with jurisdiction over engine

houses and matters pertaining to road work; succeeding F. H. Reagan, resigned to accept service elsewhere.

CHARLES W. MCGUIRK, general foreman in the motive power department of the Delaware, Lackawanna & Western at Scranton, Pa., has been appointed assistant master mechanic at Scranton, succeeding B. H. Davis.

E. R. BATTLE, general foreman of the Grand Trunk at Deering, Me., has been appointed master mechanic of the Eastern lines, with office at Montreal, Que.



E. R. Battle

Mr. Battle was originally employed by the Grand Trunk as a machinist apprentice at Stratford, Ont., from December 1, 1902, to December 1, 1907, when he became a machinist. He served in this capacity until January, 1909, when he was advanced to the position of shop inspector at Stratford. On March 12, 1910, he was appointed locomotive foreman at Fort Erie, Ont., which position he held till July 1, 1914. He then was transferred to Deering, Me., where he served as general foreman until he was promoted to his present position in September, 1917.

W. J. McLEAN, for the past five years master mechanic of the Kettle Valley at Penticton, B. C., has resigned.

CHARLES J. HALLIWELL, inspector in the office of the general superintendent of motive power of the Pennsylvania Railroad at Altoona, Pa., has been appointed master



C. J. Halliwell

mechanic in charge of the company's shops at Mt. Carbon, Pa., succeeding J. H. Fulmor. Mr. Halliwell was born at Altoona, Pa., on March 29, 1874. He entered the service of the Pennsylvania Railroad as a laborer in the Altoona shops on July 3, 1889. Two years later he became an apprentice, and on April 22, 1895, he was promoted to machinist. On October 1, 1899, he became gang leader at Altoona, and in March of the following year was advanced to foreman on the Pittsburgh division. Mr. Halliwell was made assistant master mechanic of the Pittsburgh division on March 1, 1906, and on December 1, 1912, returned to Altoona as inspector in the office of the general superintendent of motive power, acting in that capacity until September 1, 1917, when he received his appointment as master mechanic at Mt. Carbon, Pa.

JAMES B. DIVEN, assistant engineer of motive power of the New Jersey division of the Pennsylvania Railroad, at New York, has been appointed master mechanic of the Philadelphia Terminal division, with office at West Philadelphia,

Pa., succeeding P. L. Grove. Mr. Diven was born on October 21, 1878, at Landisburg, Pa., and graduated from the Williamson School in 1898. He began his railroad service on April 18, 1898, as an apprentice at the Altoona shops. He was made machinist on May 15 of the following year, and on April 1, 1900, was appointed inspector in the office of the assistant engineer of motive power at Altoona. On August 1 of the same year he was made draftsman in the office of the superintendent of motive power at Buffalo, and on November 1 was appointed inspector. On January 15, 1902, Mr. Diven was advanced to the position of assistant master mechanic at Verona, N. Y. He was promoted to master mechanic of the Cumberland Valley Railroad on September 30, 1904, and from April 1, 1907, until he received his recent appointment, he was assistant engineer of motive power of the New Jersey division.

FRANKLIN E. MARSH, assistant master mechanic of the Altoona machine shop of the Pennsylvania Railroad, has been appointed master mechanic of the New York, Philadelphia & Norfolk, with headquarters at Cape Charles, Va., succeeding A. W. Byron. Mr. Marsh was born on November 20, 1876, at Newark, N. J. He attended the public schools of that city and completed his education in the Newark Technical School. He was first employed in railroad service on January 25, 1897, as a special apprentice on the Pennsylvania Railroad, becoming a machinist on May 1, 1901, and inspector in the Altoona machine shop on July 1 of the same year. On July 12, 1902, Mr. Marsh was transferred to the Wilmington, Del., shop, as inspector, and was made assistant road foreman of engines of the Maryland division on June 8, 1903. He was advanced to assistant master mechanic at Trenton, N. J., on December 10, 1906, and was appointed assistant master mechanic of the Altoona machine shop on September 26, 1910, which position he held when he received his recent appointment.

E. S. McMILLAN has been appointed road foreman of engines of the Grand Trunk, Montreal terminals, succeeding F. H. Holland, assigned to other duties.

VICTOR U. POWELL, master mechanic of the Illinois Central at Freeport, Ill., has been transferred to the Chicago Terminal and Illinois division, with office at Burnside shops, Chicago, succeeding Henry C. Eich.

A. B. OGILVIE has been appointed road foreman of engines of the Grand Trunk, with jurisdiction over the thirty-first and thirty-second districts, including the Ottawa terminal, succeeding W. M. Cooper, assigned to other duties.

G. M. WILSON, assistant master mechanic of the Grand Trunk at Montreal, Que., has been promoted to master mechanic, with headquarters at the same place, succeeding A. A. Mayer, retired. Mr. Wilson was born in Belfast, Ireland, in 1867. After serving a machinist apprenticeship he entered the employ of the Grand Trunk in November, 1890, as machinist, at Fort Gratiot, Mich., and subsequently filled the positions of machine shop foreman, general foreman of the Toronto shops, general inspector of tests and assistant master mechanic. In 1907 he had charge of the layout, and supervised the installation of the entire machinery equipment of the main shops of the Western division, at Battle Creek, Mich., and on the completion of this work was located at Ottawa, Ont., supervising the installation of the power house in connection with the new station and the Chateau Laurier.

SHOP AND ENGINEHOUSE

A. C. ADAMS, master mechanic of the Seaboard Air Line at Raleigh, N. C., has resigned that position to become superintendent of shops of the New York, New Haven & Hartford at Readville, Mass. Mr. Adams was educated in the common schools and served a machinist apprenticeship

on the Missouri Pacific. He went to the Chicago, Rock Island & Pacific as a machinist in 1887 and was promoted to master mechanic on the Colorado division in 1900, later being transferred to the Oklahoma and Missouri divisions. In 1906, he accepted a position as master mechanic on the Alliance division of the Chicago, Burlington & Quincy and in November, 1907, went to the Delaware, Lackawanna & Western as master mechanic at Hoboken, N. J. In November, 1908, he entered the service of the New York, New Haven & Hartford, acting in the same capacity on the Shore Line division. He resigned that position in February, 1911, to become superintendent of motive power of the Spokane, Portland & Seattle and the Oregon Electric & United Railways at Portland, Ore. In February, 1914, he went into the supply business, but again entered railroad service, becoming master mechanic of the Seaboard Air line, which position he held until recently.

J. C. BRECKENFELD, inspector of tools and machinery of the New York, New Haven & Hartford, has been appointed assistant superintendent of locomotive shops, with headquarters at Readville, Mass.

H. W. BREWER, formerly erecting shop foreman at the West Albany shops of the New York Central, has resigned to become general foreman of the Du Bois (Pa.) shops of the Buffalo, Rochester & Pittsburgh.

JOSEPH GREISER, general foreman in the motive power department of the Delaware, Lackawanna & Western at Scranton, Pa., has been appointed superintendent of shops, with jurisdiction over the Scranton locomotive shops.

JOHN REID, general foreman of shops of the New York, New Haven & Hartford at New Haven, Conn., has been promoted to the position of inspector of tools and machinery, succeeding J. C. Breckenfeld.

E. V. WILLIAMS, formerly general foreman of the New York Central at the West Albany shops, has resigned to accept the position of superintendent of shops of the Buffalo, Rochester & Pittsburgh, with headquarters at Du Bois, Pa.

CAR DEPARTMENT

T. A. HEMINWAY, car repair foreman of the Delaware & Hudson at Colonie, N. Y., has been appointed divisional car foreman of the Saratoga division, with headquarters at Colonie.

J. E. O'NEIL, car repair foreman of the Delaware & Hudson at Oneonta, N. Y., has been appointed divisional car foreman of the Susquehanna division, with headquarters at Oneonta.

PURCHASING AND STOREKEEPING

J. A. BRACKETT, division storekeeper of the Atchison, Topeka & Santa Fe at Barstow, Cal., has been transferred to Calwa, Cal., succeeding O. H. Hansen, resigned to enter military service.

JOHN E. BYRON has been appointed general storekeeper of the Boston & Maine, with office at Boston, Mass.

C. N. DAVIDS has been appointed purchasing agent of the Denver & Salt Lake, with headquarters at Denver, Colo., succeeding A. A. Dawley, assigned to other duties.

J. L. DIESSL has been appointed division storekeeper of the Atchison, Topeka & Santa Fe at Riverbank, Cal., succeeding H. R. Spann.

T. S. EDGELL has been appointed division storekeeper of the Mobile & Ohio, with office at Tuscaloosa, Ala., succeeding W. O. Jamison, resigned.

BAYLIS McCALIN has been appointed division storekeeper of the Atchison, Topeka & Santa Fe at Barstow, Cal., succeeding J. A. Brackett.

G. O. HIXON, division storekeeper of the Atchison, Topeka & Santa Fe at Gallup, N. Mex., has been transferred to Winslow, Ariz., succeeding E. J. Burns, assigned to other duties.

F. B. MACSWAIN, storeman on the Canadian Pacific at Ogden, Alta., has been appointed storekeeper, with headquarters at Calgary, succeeding G. F. Rosengren, transferred to Lethbridge.

T. W. MADDEN, storekeeper of the Canadian Pacific, at Revelstoke, B. C., has been transferred to Coquitlam.

H. SHOEMAKER, district storekeeper of the Baltimore & Ohio at Cincinnati, Ohio, will in future have jurisdiction over the Northwest district and Chicago terminals.

H. R. SPANN, division storekeeper of the Atchison, Topeka & Santa Fe at Riverbank, Cal., has been transferred to Gallup, N. Mex., succeeding G. O. Hixon.

W. E. STEEN, storekeeper of the Baltimore & Ohio at Washington, Ind., has been appointed district storekeeper, with jurisdiction over the Southwest district.

N. C. STIBBS, storekeeper of the Canadian Pacific at Lethbridge, Alta., has been transferred to Nelson, B. C., succeeding D. S. Schofield, transferred to Revelstoke, B. C.

G. H. Walters, engineer of tests in the stores department of the Chicago, Milwaukee & St. Paul, at Milwaukee, Wis., has been appointed assistant purchasing agent, with office at Chicago, succeeding A. J. Jennings, resigned.

OBITUARY

C. S. WOOD, for 21 years general foreman of the Boston & Maine roundhouse at Concord, N. H., died on September 12, at the age of 54. Mr. Wood entered the service of the Boston & Maine in 1881 as locomotive fireman, became an engineman in 1885, and general foreman in 1896.

J. F. ENRIGHT, superintendent of the motive power and car departments of the Denver & Rio Grande, died at his home in Denver, Colo., on September 4, after an illness of about one year. He was born at Savannah, Ga., in 1867, and entered railway service in 1885 as a machinist apprentice of the Savannah, Florida & Western, now a part of the Atlantic Coast Line, and remained in the Savannah (Ga.) shops of that road until 1895, when he was appointed general foreman of the shops at Montgomery, Ala. He was subsequently general foreman of shops of the same road at Waycross, Ga., and later master mechanic at Montgomery, Ala. From January, 1902, to January, 1907, he was master mechanic on the Mobile & Ohio at Whistler, Ala., and from the latter date to December, 1909, was superintendent of machinery of the International & Great Northern at Palestine, Texas. From the time he left the I. & G. N. up to the time of his death he was superintendent of the motive power and car departments of the Denver & Rio Grande, with headquarters at Denver, Colo., and during a portion of that period had jurisdiction also over the mechanical department of the Western Pacific.



J. F. Enright

SUPPLY TRADE NOTES

Russell Dale, general sales manager of the Rich Tool Company and manager of the Tungsten Valve Company, Chicago, died in that city on September 22.

E. Kennedy, formerly assistant general foreman at the West Albany shops of the New York Central, is now connected with Manning, Maxwell & Moore, with headquarters at Chicago.

George E. Scott, vice-president of the American Steel Foundries, has become associated with the work of the Red Cross at Washington on the staff of the business manager, H. D. Gibson.

The Acar Manufacturing Company, 30 Church street, New York, has opened a Chicago office, in charge of Leland T. Johnson at room 649, McCormick building. Mr. Johnson will handle matters for this company in the western territory.

The Macleod Company, Cincinnati, Ohio, manufacturers of sand blast equipment and metallurgical furnaces, has found it necessary to enlarge its plant in order to take care of its rapidly expanding business and has increased its capital to \$100,000.

Edward F. Carry, president of the Haskell & Barker Car Company, Chicago, has been appointed director of the government shipping board with headquarters at Washington, D. C. Mr. Carry will not sever his connection with the Haskell & Barker Car Company.

Arthur C. Sullivan, formerly with the Hensley Trolley Manufacturing Company, of Detroit, Mich., has been appointed a sales representative of the National Railway Appliance Company, New York. Mr. Sullivan will be attached to the Chicago office of the company.

The Robinson Paint Company, Aurora, Ill., announces that it has purchased the plant, business and good will of the Akron Mining, Milling & Manufacturing Company. The business will be continued along the same general lines as heretofore, with the same organization.

Harry L. Allen, assistant fourth vice-president of the American Steel Foundries, died at Cleveland, Ohio, on August 31, at the age of 35 years. Mr. Allen had been with the company 15 years, coming to it at the time of its organization, from the American Steel Castings Company.

John E. Woods, formerly manager of sales of the Carnegie Steel Company, the Illinois Steel Company and the Tennessee Coal, Iron & Railroad Company, at Cincinnati, Ohio, has been appointed assistant general manager of sales, with offices in the Carnegie building, Pittsburgh, Pa. Mr. Woods succeeds John W. Dix, deceased.

Horace M. Wigney, formerly superintendent of transportation of the Pacific Fruit Express Company, and recently president and general manager of the Dairy Shippers' Despatch Company and the Federal Refrigerator Despatch, has entered the railway supply and equipment business in his own name, with offices at 750 Railway Exchange building, Chicago.

The McCarthy Drill & Tool Corporation of Toledo, Ohio, with executive offices at 30 Church street, New York, has purchased the Toledo Drill & Tool Company, of Toledo, which has just moved into a new and enlarged fire-proof two-story structure, where it has arranged to turn out large quantities of high-speed drills, in addition to a full line of cutters and reamers.

George A. Turville, secretary and treasurer of the Crucible Steel Company, has also been elected a vice-president. J. M. McComb, credit manager, has been made assistant treasurer.

The Crane Packing Company of Chicago, manufacturer of "John Crane" flexible metallic packing for all vapors and liquids, announces the establishment of an Eastern office in the Woolworth building, New York. Their engineer, A. W. Payne, who has had much experience with packing problems in the oil, mining and industrial fields, has been placed in charge of this branch.

The United States District Court for the Western District of New York has handed down its decision that the Gould "Simplex" system of electric car lighting is not an infringement of the Creveling patent, 747,686, owned by the Safety Car Heating & Lighting Company, and has directed that the suit be dismissed with costs to the Gould Coupler Company. This disposes of the last charge that the Gould "Simplex" system infringes any patent.

E. N. Sanctuary, president of the Oxy-Acetylene Appliance Company, of New York, formerly engineer and secretary of the Bowers Southern Dredging Company, of Galveston, Tex., and an experienced construction engineer, has been commissioned a captain in the Engineer Officers' Reserve Corps, and has been assigned to the Washington office of S. M. Felton, director general of railways, in charge of the personnel of railway troops organized for service abroad.

The Titanium Alloy Manufacturing Company announces that the constantly increasing demand for superior bronze and brass castings has compelled it to enlarge its bronze department and make a distinct unit of it under the name of the Titanium Bronze Company, Inc. The company's works are at Niagara Falls, N. Y.; its sales offices at Buffalo, and its general offices at 165 Broadway, New York.

The Bradford-Ackermann Corporation, Forty-second street building, New York City, has been made the eastern sales office for the Young Brothers Company, Detroit, Mich. The sale of Young ovens, for japaanning and drying purposes, will in the future be handled by this eastern office for the New England states, New York, New Jersey, Maryland, Delaware and eastern Pennsylvania. An engineering department will likewise be available for manufacturers in the East who are interested in quick drying and baking processes, and special oven designs will be offered to meet various requirements.

W. G. Dunham, since 1907 in charge of the manufacture of McCord & Co., products in Canada, with headquarters at Brantford, Ont., died September 8 at the age of 62 years. Mr. Dunham was born in Canada, and came to this country as a young man. In 1884 he entered the employ of the Chicago, Burlington & Quincy, and was with that road as foreman of the old Sixteenth street passenger yards of that company in Chicago during the Debs strike in 1894, when he succeeded in keeping his department operating without damage to railroad property. He entered the employ of McCord & Co. in 1902, and prior to going to Brantford was mechanical inspector.

H. McB. Parker, sales representative of the Hunt-Spiller Manufacturing Corporation, Boston, Mass., who entered the Officers' Training Camp at Plattsburg in May, and was thereafter detailed to special duty in the Submarine Signal Company, has enlisted in the United States Navy, and has been assigned to one of the United States destroyers, which has sailed for France. C. L. Galloway has been appointed sales representative of the Hunt-Spiller Manufacturing Corporation for the Northeastern district. Mr. Galloway for the last 18 years has been in the employ of the New York, New Haven & Hartford, in and about Boston, and serving in various capacities in the mechanical department.

Thomas H. Garland, president of the Garland Ventilator Company, Chicago, whose death was announced in the *Railway Mechanical Engineer*, last month, was born at Augusta, Me., on December 10, 1855. He entered railway service as a brakeman with the Chicago, Burlington & Quincy, at Quincy, Ill., in 1872, and several years later became baggage man at the same point. In 1882 he was promoted to clerk in the freight office at Chicago, and later was appointed chief clerk in the same department, which position he held until his appointment as superintendent of refrigerator car service. In 1908 he left the Burlington to engage in the railway supply business in which he was interested until his death.

Frank W. Davis, manager of railroad sales of the Lake Erie Iron Company, Cleveland, Ohio, died very suddenly of heart disease at the Royal Muskoka hotel, Muskoka, Canada, August 8. Mr. Davis was born in Cleveland, January 1, 1857. He received his education in the Cleveland public schools and Oberlin College and commenced his business career with Bingham & Phelps, who at that time conducted a retail hardware business on Ontario street. He afterward engaged as a commercial traveler, and while on one of his trips he became acquainted with C. W. Scofield, secretary and treasurer of the Lake Erie Iron Company, who eventually employed him as a salesman for that company. He remained in the service of the Lake Erie Iron Company, for 27 years.

Automatic Straight Air Brake Company

The Automatic Straight Air Brake Company has been incorporated under the laws of Delaware with a capital stock of \$5,000,000 preferred and \$20,000,000 common to manufacture and sell a new type of air brake, the invention of Spencer G. Neal, who is the designing engineer of the company.

The directors are A. B. Boardman, A. M. McCrea, K. B. Conger, H. I. Miller, C. R. Ganter, S. C. Holaday, A. M. Trueb and G. C. Pierce.

The officers will be H. I. Miller, chairman of the board and president; K. B. Conger, vice-president and treasurer; A. M. Trueb, secretary and auditor, and G. C. Pierce, chief engineer. The office of the company is at 14 Wall street, New York.

A railroad officers' demonstration of the brake will take place in New York during the early part of October, and arrangements for manufacture are well under way. The company will not build its own plant until after the war.

Baldwin Locomotive Works

President Alba B. Johnson of the Baldwin Locomotive Works announces the following changes in the organization of that company and of the Standard Steel Works Company. In the Baldwin Locomotive Works no change has been made with respect to William L. Austin, chairman of the board, or Alba B. Johnson, president. Samuel L. Vauclain, hitherto vice-president, however, becomes senior vice-president; Grafton Greenough, sales manager, now becomes vice-president in charge of sales; J. P. Sykes, general superintendent, becomes vice-president in charge of manufacture, and James McNaughton, formerly vice-president of the American Locomotive Company, becomes consulting vice-president.

In the Standard Steel Works Company, William Burnham, heretofore president, has been elected chairman of the board, and other officers have been elected as follows: Alba B. Johnson, president; Samuel M. Vauclain, senior vice-president; Robert Radford, vice-president and treasurer; A. A. Stevenson, vice-president and engineer; Wm. H. Pugh, Jr., secretary; T. L. Rogers, assistant treasurer, and O. C. Skinner, works manager.

Railway Mechanical Engineer

Volume 91

November, 1917

No. 11

CONTENTS

EDITORIALS:		Hospital Car for the Erie.....	637
Enginehouse Terminal Competition.....	609	New Floor Plans for Postal Cars.....	637
The M. C. B. 700-lb. Wheel.....	609	SHOP PRACTICE:	
Do Not Slight the Work Reports.....	609	Locomotive Terminal Delays.....	639
Slackers in the Repair Forces.....	610	Steam Hammer Dies for Superheated Flues.....	640
Rolling Stock Situation in Germany.....	610	Plan Cylinder Grinding Work.....	641
Arrangement of Car Repair Yards.....	610	A Time-Saving Attachment for the Planer.....	643
Shop Efficiency and Illumination.....	610	High Speed Typed Tools.....	643
The War Performance of Cars and Locomotives.....	611	Electric Welding Instructions.....	644
New Books.....	611	Method of Testing Valves.....	645
COMMUNICATIONS:		Design of Forging Machine Dies.....	647
A Protest! Educate the Trainmen.....	612	Universal Driving Box Chuck.....	648
GENERAL:		Lubricating Air Cylinders of Cross Compound Type Air Compressors.....	648
Foreign Machine Tool Demands.....	613	Jigs for Planing Outside of Crosshead Shoes.....	648
Word from Our Railway Men in France.....	615	Boring Equalizer Brackets in Place.....	649
Railway Regiments' Tobacco Fund.....	616	Clear Vision Windows.....	649
A Message from the Traveling Engineers.....	616	NEW DEVICES:	
Use of Pulverized Coal in Brazil.....	617	Portable Crank Pin Press.....	650
Converted Switch Locomotives.....	619	The American Trainagraph.....	650
Prevention of Locomotive Smoke.....	621	Drilling Machine with Tapping Attachment.....	651
Mechanical Department a Factor in Train Loading.....	624	Motor Headstocks for Woodworkme Lathes.....	651
Locomotive Terminal Detention Records.....	625	Motor Drive for Radial Drills.....	652
CAR DEPARTMENT:		Abrasive Belt Finishing Machine.....	652
Reclaiming Car Material on the Rock Island.....	627	Automatic Starter for Induction Motors.....	653
Piece Work and Car Inspectors' Duties.....	628	NEWS DEPARTMENT:	
Train Brake Leakage Determinations.....	629	Notes.....	654
Hot Boxes on Freight Cars.....	632	Meetings and Conventions.....	655
Automatic Straight Air Brake.....	633	Personal Mention.....	656
Calculating Height of Gram Line for Box Cars.....	636	New Shops.....	659
		Supply Trade Notes.....	660
		Catalogues.....	662

Enginehouse Terminal Competition

Contrary to our expectations, it has been impossible to publish in this issue the prize winning articles of the engine-house competition which closed October 22. There were a number of contestants and the judges have not had an opportunity to study the papers sufficiently to award the prizes. The decisions will be made shortly and those to whom the prizes are awarded will be so advised. This problem is exceedingly important at this time and was made the subject of a paper before the Western Railway Club, which is published elsewhere in this issue. Particularly good suggestions are brought out in this paper, which should be carefully studied.

The M. C. B. Seven Hundred Pound Wheel

The new design of seven hundred pound wheel for forty ton cars adopted by the Master Car Builders' Association appears to have certain important advantages. The performance will be watched with great interest when this type is placed in service. The principal object of the new design is to lessen the liability of cracks occurring in the plate of the wheel. Cracked plates are not only one of the most dangerous defects in wheels, but also one of the most difficult to detect. The examination of a large number of standard M.C.B. cast iron wheels which failed in the plate showed that there was a tendency for sand to gather at the re-entrant curve of the outer face of the plate, thus reducing the effective strength at that point. In the new arch plate wheel the section has been made thicker and the curvature has been changed at this point to do away with the tendency for sand to gather in the mould. It seems

reasonable to assume that the alterations made in the design will result in a considerable reduction of the wheel failures due to defects in the plate.

Do Not Slight the Work Reports

Upon the running repair forces at the engine terminals rests to a very large extent the success with which the power is maintained and made to perform its full duty. An engine failure at this time is more than ordinarily expensive and the locomotives are more liable to failure because every opportunity is taken to overload them. This means that they must be kept in good condition. The engine-house forces should be so organized that the work reported to be done on a locomotive when it is received at the engine terminal, will not be slighted. A locomotive can be properly maintained only by following the work reports closely. The engineman is in better position to observe defects in a locomotive which interfere with its operation, than the inspector at the terminal, and his report should be given careful consideration. Too many times the engineman is prone to be too general in his reports, and an energetic campaign should be waged to impress upon their minds the importance of being specific in their reports.

The reports of the road foremen of engines should be watched with great care. These men, expert locomotive drivers, are able from their long experience to accurately diagnose the ailments of the locomotives. Their reports of defects should be given the weight they deserve and the repairs that they suggest should be made. The enginehouse has become the firing line of our transportation system; the locomotives, the guns. Unless they are able to shoot straight

and accurately, our transportation facilities will be crippled. There is no question but what the forces of many enginehouses should be enlarged, and unquestionably additional machine tools would be of great assistance. The enginehouse men are the ones that realize this better than anyone else and they should impress upon their superiors the necessity for reinforcements where they are needed. The condition of the locomotives at this time affects as never before the efficiency of our transportation system. They must be kept running and be made to do the full measure of their work. They cannot do this unless they are properly maintained.

**Slackers
in the
Repair Forces**

With the increase in pay for the workmen in almost every craft and the large opportunities for overtime on very nearly every railroad, the shop men are making more money than ever before. Some of them, forgetful, perhaps, of the importance of their work and of the need their country has for their services in the railroad shop, take advantage of these "good times" and give themselves too frequently a day or two "off." In fact the practice has become so general in some shops that it is necessary to send messengers to bring the men back to work. Whether these men realize it or not, they are slackers. The country, and particularly the railroads, need the active service of every man possible—and especially the craftsmen. If these men are earning so much money that they can afford frequent holidays, let them do the patriotic thing and buy Liberty bonds or save their money for the next loan which is sure to come.

We must all do our duty to our country if we are to win this war—and our duty is to do all the work in our particular line we can, and a little bit more. If worse comes to worse and the railways are unable to meet properly the demands for power and equipment there is a possibility of the Government taking over the railways and operating them as a military machine. This surely is not to be desired. The men must be made to realize how important a part they are playing in this struggle—their duty is as clearly defined as that of the soldier, sailor or marine. They must support by their labors the men who are taking life and death chances at the front.

**Rolling Stock
Situation
in Germany**

Because of the extreme shortage of material in Germany it has often been wondered just what the condition of the rolling stock is in that country. A small amount of information in regard to this is found in a letter published in the Railway Gazette of London, which was dated Berne, Switzerland, August 30. Particular attention is called to the lack of lubricants for both freight and passenger cars. It has been noticed in Switzerland that the journal boxes of the cars in which German iron and coal are sent are invariably empty. The Swiss federal railways, in accordance with their custom, fill these boxes and in this way Germany gets a little lubricating material.

Concerning the condition of the equipment, but little definite information has been obtained, but statements have been made in Switzerland to the effect that while about eight per cent of German cars and locomotives were ordinarily under repair, at the present time over 23 per cent is out of service for some reason or other. It is also stated that this percentage has materially increased since the time the information was obtained. The correspondent speaks of cast iron tubes being used in locomotive boilers, but undoubtedly iron tubes are meant, as it was the custom of the German railways to use bronze or copper tubes. Another interesting bit of information is that steel passenger cars, the floors and walls of which are covered with wood, are being built. The cars are longer than the wooden cars and it is said that the

change is to be gradually effected on all German railway lines. It is further claimed that these steel cars are much lighter than the wooden ones because they require comparatively far less material in their construction. It would seem from this statement that these steel cars are being built in an effort to conserve the lumber supply rather than as in this country to provide a car which is materially stronger.

The financial condition of the railways is very well illustrated by the fact that surtaxes ranging from 10 to 16 per cent on fourth and first class passenger tickets respectively, are made with an extra charge for baggage of 12 per cent above the ordinary cost of its conveyance. Further than this, an additional charge of seven per cent has been made on the freight charges of all goods sent by rail, whether for short or long distances, and certain commodities must be sent by water wherever this is possible.

**Arrangement
of Car
Repair Yards**

The car is an important factor in the transportation problem at this time. The value of a car today is possibly higher than at any time in the history of the railroads of this country. The cars must not only be kept in repair, but they must be kept in action as much as possible. The manner in which car repairs are handled in the repair yards has a large bearing on the rapidity with which the repairs are made. To indiscriminately switch defective cars into the car repair yards will result in tying up a large amount of equipment because cars requiring light repairs may be pocketed between cars requiring heavy repairs. By placing the heavies on tracks by themselves and the cars requiring light repairs by themselves, less equipment will be tied up.

The cars to be repaired should be examined by the car foreman as they are brought to the yard and the switching crews should be made to spot the cars where the car foreman directs. The extra time taken in switching will be more than saved by getting the cars having the light repairs through the repair yard in a hurry, and back into service. It is also desirable to have an open end yard so that the damaged cars can be brought in from one end and passed out repaired, through the other end. It may be possible that a cross-over here and a switch there will greatly increase the output of a repair yard. The foremen in charge of these yards should give this matter careful attention and be ready with facts to show how and why their facilities should be improved. By doing this the congestion of the car yards may be reduced and the car supply will be increased.

**Shop Efficiency
and
Illumination**

Illumination considered in a field by itself has received but little consideration in the railway shop. More often the problem of artificial lighting has been met by the placing of a drop light here and there or by running an extension from a nearby socket to the place desired and hanging the lamp on some convenient or make-shift bracket requiring the workman to move it about to suit his particular needs. This is extremely undesirable both from the workman's standpoint and from the net cost for the lighting.

Poor lighting facilities materially interfere with the output of the workmen. Studies made of the effect of good lighting on shop production show that good light will add an average of approximately one-half an hour a day per man to the output which represents a production increase of five per cent, brought about by an expenditure of only one-half of one per cent of the wages; a saving equal to ten times the expense. The subject is of such importance that the Department of the Interior recently issued a technical paper on the relation between illumination and efficiency. The paper points out that actual instances have been reported where

production has been increased from two to ten per cent as a result of improved lighting.

Further than this, with a properly installed and adequate lighting arrangement the men will be more contented, the shop will be more easily supervised and the accidents will be reduced. When it is remembered that an accident not only deprives the shop of the services of the workman but also increases the actual operating expense due to the damage claims, the advantage of reducing the liability of accidents is evident.

With the installation of any system proper arrangements should be made for keeping the lights clean. There is nothing on railroads that depreciates so rapidly as does the efficiency of the lighting system. The rapid collection of dust and soot on a lighting fixture will easily cause the illumination to be reduced 50 per cent of its initial value in a short time. The standard of cleanliness for lamp reflectors should depend on a balance between the cost of cleaning and the loss by not cleaning. It has been shown that the loss on a 1,000-watt gas-filled lamp with porcelain enameled reflector will be approximately \$34 if allowed to go without cleaning for a year. Figures available for an average shop show that it is possible to clean such reflectors for an average cost of \$1 a month or \$12 a year. It would obviously be poor engineering practice to put in more light than was necessary; therefore, it certainly is good practice to keep the reflectors clean so that the installation will give the illumination it was designed to give.

The War Performance of Cars and Locomotives

Interesting are the statistics showing the performance of cars and locomotives in this country since war was declared and the Railroads' War Board was organized in the early part of last April. With only 1.3 per cent more locomotives in service and only 2.3 per cent more freight cars than in July, 1916, railroads operating 220,054 miles of line in July, 1917, handled 20.2 per cent more ton miles of revenue freight. In other words, the 30,277 freight locomotives in service on the roads from which these statistics were obtained, handled in July the equivalent of 33,434,368.526 tons of revenue freight one mile, or an average of 1,104,283 ton miles for each locomotive, as compared with 930,455 in July, 1916, an increase of 18.7 per cent in the efficiency of each locomotive. The revenue ton miles per car for this particular month increased 17.5 per cent.

This was accomplished by increasing the number of tons of freight to each train from 617 to 681, or 10.4 per cent, and loading an average of 2.7 tons more, or 11.1 per cent, in each car, while the average mileage run by each locomotive per day was increased 4.4 miles or 6.8 per cent. The average mileage per car per day increased 1.9 or 7.2 per cent. While the percentage of empty car mileage was increased slightly, 3.9 per cent, the average number of cars in shop or awaiting shop was reduced 9.1 per cent and the average number of locomotives in shop or awaiting shop was reduced 8.7 per cent.

In the months of April, May, June and July, 1916, the average miles made per locomotive per day never exceeded 66 miles. In the same months of 1917 the average mileage per locomotive per day never was less than 68.8 miles, and in June it was 70.7 miles, and in May it was still more—71.3 miles.

These records show how well the railways, and particularly the mechanical department of the railways, have responded to the call of the country for transportation. The demands for cars and locomotives have been ably met but the end is not in sight. The winter with its snow and ice will be the real test. It is then that the locomotives, particularly, will prove their worth. Their steaming qualities

must be carefully watched. Everything possible should be done now to improve them and prepare them for the winter before it is too late.

In other years it has been possible to go into the winter with a reserve of power. This year this cannot be done. It is not a question of how many extra locomotives will be available, but how can the power and the staying qualities of the present locomotives be increased to meet the more severe conditions and the constantly increasing demands. This is the real problem of the mechanical department men today.

NEW BOOKS

Effects of Storage Upon the Properties of Coal. By S. W. Parr. 44 pages, 6 in. by 9 in., illustrated, bound in paper. Published as Bulletin No. 97 by the Engineering Experiment Station, University of Illinois, Urbana, Ill.

A series of experiments, started in 1910, to determine the effects of storage upon the properties of bituminous coal has recently been completed by the engineering experiment station of the University of Illinois. The object has been to devise methods of storing which will avoid the risk of spontaneous combustion and to determine the extent to which coal deteriorates in storage. It is shown that, if properly sized and carefully handled, coal may be stored without danger of spontaneous combustion; that the actual loss of heat value, or deterioration, resulting from storage is slight; and that underwater storage eliminates entirely all risk of spontaneous combustion or of deterioration. The extent of the waste and economic loss incident to the present method of seasonal production, with its attendant abnormal demands upon transportation facilities is discussed, and it is estimated that the lack of storage facilities in large distributing centers necessitates a capital investment in mines and railroad cars of \$500,000,000 in excess of the amount which would be required if production could be maintained at a uniform rate throughout the year.

Locomotive Handbook. Compiled by the American Locomotive Company. Bound in leather, 195 pages, 3½ in. by 6 in. Published by the American Locomotive Company, 30 Church Street, New York. Price 75 cents.

The locomotive designer has always felt the need of a compact and concise source of information on the fundamentals of locomotive design for his ready reference. The American Locomotive Company has done much to supply this need in this *Locomotive Handbook* which has just been published. Heretofore the locomotive designer has been compelled to refer to material published in various places to get the information he desired on locomotive design, or else possibly to refer to rather cumbersome notes compiled by himself. The *Locomotive Handbook* will, therefore, fill a real need in the railway field.

At the beginning of this book is given a brief description of the American Locomotive Company. This corporation has a full working capacity of 3,000 locomotives per year and employs 20,000 men. This description is followed by formulae and tables giving the tractive effort of both simple and compound locomotives. The next subject considered is Train Resistance, the material being contributed by F. J. Cole, chief consulting engineer of the American Locomotive Company. It includes the resistance of freight and passenger cars of different weights and at different speeds, together with information showing how the results of tests check with the values given in the handbook. A comparison of the resistance of four and six wheel trucks is made and interesting information is included regarding the effect of a stop in increasing resistance. All phases of the subject are considered, such as velocity grades, acceleration, weather conditions, track resistance, etc.

Some eighteen pages are devoted to the subject of locomotive ratios, which is also written by Mr. Cole and is based

substantially on bulletin 1017 issued in January, 1914, by the American Locomotive Company. Illustrative examples are given to show how the information given under this head is to be used. Both saturated and superheated steam locomotives are considered. Following this is a section of about eight pages which gives the efficiency of longitudinal seams, stresses in staybolts and crown stays, method of bracing the back head and front tube sheet, the shearing stresses on rivets, etc.

Interesting information is also given on counterbalancing and fuel oil, the counterbalancing information being taken from the 1915 proceedings of the American Railway Master Mechanics' Association. Ten pages are devoted to the Interstate Commerce Commission's rules on locomotive machine and boiler inspection and testing.

The balance of the handbook contains methods used by the American Locomotive Company in the design of axles; crank pins, frames, piston rods, helical springs, elliptical springs, location of gage cocks for various grades over which the locomotive operates, piston thrust, etc. Information in tabular form is also given regarding the proper pressures for mounting wheels and piston rods. Several tables are included showing the effective area of staybolts, the proper location of tires on driving wheels, standard U. S. screw threads, properties of saturated and superheated steam, pipe threads, wire and sheet metal gages, moduli of rectangular and circular sections, decimal equivalents, speed-second table, tangent deflections, metric unit and U. S. equivalent tables, etc. Information is also given regarding valve setting and detailed instructions are included for setting the Walschaert valve gear.

Much time and a great deal of care has been exerted in the compilation of the information published in this book and it will be of considerable assistance to railroad men interested in locomotive design.

Locomotive Valves and Valve Gears. By Jacob H. Yoder, supervisor apprentices, Pennsylvania Railroad, and George E. Wharen, instructor mechanical engineering, University of Pennsylvania. 270 pages, 6 in. by 9 in., illustrated. Bound in cloth. Published by D. Van Nostrand Company, 25 Park Place, New York. Price, \$3 net.

The purpose of the authors in the preparation of this volume has been to provide a treatise on valve gears to meet the requirements of railroad shop men who wish to acquaint themselves thoroughly with the operation of gears used in modern locomotive practice, and to fit themselves to master the intricacies of valve setting. The material has been compiled largely from notes used in the instruction of apprentices of the Pennsylvania Railroad and from knowledge gained by the authors in practical shop experience. Highly technical discussions of the principles of valve motion have been avoided.

The first chapter of the book is devoted to a description of the various types of locomotive valves, and following this the Stephenson and Walschaert valve gear are each dealt with in detail, the relation of the various parts and the effects of the inherent distortion of the motion upon the valve events being covered in a way which should readily be followed by the novice. The other valve gears used in locomotive practice, including the Baker, Southern and Young gears, are all described in a following chapter. The remainder of the text is given over to a detailed study of the effect on steam distribution of alterations in the valve and its events, and of locomotive valve setting.

The text is well illustrated throughout with diagrams and photographs and the book will be a valuable addition to the library of any ambitious mechanic. While not primarily a treatise on valve design, the book should prove of value to the designer and engineer engaged in locomotive work, as in it may be found a description of most of the devices which have been adapted to locomotive valve and valve gear practice.

COMMUNICATIONS

A PROTEST!—EDUCATE THE TRAINMEN

EUREKA, Cal.

TO THE EDITOR:

When reading your editorial in the October issue on car maintenance, showing the necessity for doing the work in such workmanlike manner that the car would stay off the repair track, it occurred to me, as it has often occurred before on reading similar articles, how seldom the matter of the abuse of cars by trainmen and switchmen is touched on. In the present day movement of cars, and especially in the freight yards, it is one continual crash and bang. Half the time the trainmen are too indifferent to give signals. If the cars fail to couple on the first impact, a violent come-ahead signal is given which generally does the work.

Not all of the fault lies with the men by any means. Trainmasters have their arms in the air, as it were, crying, "Get over the road." It is understood, of course, by the tens of thousands of freight car maintainers all over the country, that the object of the transportation department is to keep down overtime in their department. This is a worthy object as we car men admit, but we suspect that it results in the trainman being extra destructive, a tendency he always has to a greater or lesser degree.

Everyone will admit that there never has been any construction which did not have its limit of endurance. This particularly applies to cars and especially to wood underframe cars, of which a large number are daily in service in competition with steel cars and steel underframe cars. Now I wish to state, in defense of the car repair force of the United States that we do not get a square deal from the transportation department. In its endeavor to save one hour of overtime for five men, it creates and fosters an already destructive spirit which costs the railroads of this country many times what it is endeavored to save. How in the name of "Sam Hill" can a car man in the ordinary course of his work on the rip track, put into the draft sills and the draft timbers of a wood underframe car more than was put into it by the designer when the car was first built. Oceans of cars are interchanging today that were built with short draft timbers reaching as far as the body bolster, with exceptionally poor end sills in addition, many of them being cut almost through to bring the coupler up to the proper height; and lots of them have deadwoods utterly inadequate to withstand the destructive handling the cars are given by the transportation department.

What can the repair man do about it? He can apply new draft timbers, a new end sill and probably piece out the center sills, knowing all the time that a train crew if a little hurried or slightly exasperated, can knock the whole thing to smash in one second. It is doubtless true that the car maintainers of the United States need touching up, but I claim, and I can bring several hundred thousand car men to back the assertion up, that the crying need is supervision of the trainmen. They should have some regard for the railroad's property, which may mean a slight increase in the time getting over the division, although I doubt it, and will undoubtedly save thousands upon thousands of dollars now spent in repairing cars that are hit just a few hundred tons harder than they were made to stand.

R. J. QUINTRELL,

Foreman Car Department.

HEAVY SHIPMENTS OF PEACHES.—The New York State Peach Belt shipped this year 6,625 carloads of peaches, as compared with 4,459 cars last year, the best season on record.

FOREIGN MACHINE TOOL DEMANDS

Yearly Output of American Builders Tripled; Export Demands Expected to Continue After the War

THE demand for American machine tools at the present time and what it will be after the war was quite clearly shown in a series of addresses by representatives of foreign countries at the sixteenth annual convention of the National Machine Tool Builders' Association which was held in New York, October 30 and 31. The conditions indicate flattering possibilities for the builders and at the same time a prolonged demand for tools that can not be ignored by the purchasers of machine tools in this country. A large part of the export requirements after the war will be railway shop tools.

The demand for tools at the present time for the manufacture of munitions and for the upbuilding and maintenance of the various industries and railroads involved, directly or indirectly, in the great war machine is large, and will continue to be so while the war lasts. J. B. Doan of the American Tool Works Company and president of the association, stated in his opening address, that during the last three years there has been built about the same number of machine tools as would ordinarily be built in ten years. He said further regarding the war requirements that "any machine tool builder who does not bend all his mental energy to the solution of the problem of rapid output, is a lame soldier in the firing line. We must literally spend sleepless days and nights, for we are the 'machines behind the men behind the guns. No machines—no guns. The machine shops of this country are the real reserves of the army. Our country needs the service of the machine tool manufacturer now more than it ever has before. This terrific struggle means more than physical effort, it means strains of every kind, it means heavy taxes, it means personal sacrifices, it means work and lots of it."

In speaking of the future Mr. Doan called attention to the fact that on account of the present large production of machine tools there may arise the condition of an oversupplied market which, if it were found to exist, must be given careful consideration. Regarding the export trade, he said: "The machine tool builder must further improve his products, must grow more efficient and must deal with all nations in an open-minded, honest, straightforward way, which will permit us to extend our world trade to every country where a machine tool is used."

CONDITIONS IN ENGLAND

Henry Japp, C. B. E., deputy director general in the United States for the British Minister of Munitions, Production Department, spoke of the conditions in England. The following is an abstract of his remarks:

I am sure you gentlemen who manufacture machine tools must all realize the great responsibility that rests on your shoulders today, for without the machine tools of America the Allies could not have reached their present dominating position. This is a war of machinery, of the building up in three years of a machine to smash the war machine of Germany that was surreptitiously built up in the last forty years with malice aforethought to conquer the world.

The production of munitions, of course, depends almost solely on machine tools. The output in England is today twenty times what it was two years ago. There has been made in the cost of the manufacture of munitions for Great Britain during the last year, a saving of \$200,000,000 over the costs of production for the previous year, and workmen have been so prosperous that out of their savings they have contributed \$200,000,000 to the war funds. The employ-

ment of women in the manufacture of munitions and the dilution of labor with women, in the case of machine work, amounts to as high as 60 per cent, and these women have been able to earn, working piece-work, 90 per cent in excess of the time rate. They are employed in all manners of industries; viz., gage making, machining shells, foundry molding, glass blowing and shipbuilding, and, of course, agriculture. The maimed soldiers are being carefully equipped with artificial limbs and trained as skilled workmen.

Duration of War.—As to the possible duration of the war, I am no prophet, but each year the suggestion has gone out from Germany that the Germans cannot last another Winter. This is the same old effort to put the nations to sleep that was practiced for forty years while the Germans were preparing for the conflict. Make no mistake, let us not be deluded; the war, whether it ends this year or later, must be prosecuted as if it were to last for many years. Our combined effort must not relax or the good work already done will be lost. Germany is the nation that passed through the thirty years' war, so we know they have a great reserve of staying power and we must not be deluded by false predictions of early breakdown.

Conditions After the War.—If the British army is disbanded at the rate of 40,000 men per week it will require three years for the work, but as arrangements are perfected this work will no doubt be accelerated. Probably the same scale will apply to all the Allies.

Before the war we had not sufficient courage to spend \$35,000,000 a year on welfare and betterment work, but today we spend that much per day for destruction, so that we will never again fear to invest our capital in pulling down and rebuilding the wretched hovels in which the poor of Europe are housed and in carrying on beneficent work.

There will be endless work to be done after the termination of the war in construction and reconstruction. The supplies required to reinstate the devastated industrial sections of France and Belgium, to say nothing of making up for the neglect in the up-keep of the British railway systems and other public utilities will surely keep the machine tool trade fully occupied for many years, especially as at present so much machinery is allowed to run without repair.

BELGIUM NEEDS RAILROAD SHOP TOOLS

E. G. Todd, of E. Isberque & Co., Antwerp, Belgium, discussed the machine tool situation in Belgium, an abstract of which follows:

Belgium has never been a country which has produced a great number of machine tools. Aside from a few shops which produced heavy lathes for railroad work, which were not of a modern design, and two or three lathe constructors, the country was devoid of machine tool builders. There are, however, a large number of shops which require machine tools. In the district of Liege alone there are 250 machine shops, including both the large and the small. During the idle period occasioned by the war the Belgians have re-arranged their plants so that they will become much more modern and better organized as soon as they can be re-equipped.

During the first two years of the war, certain factories in Belgium were fairly busy, but the German government have stopped the export of their products and have now stripped every plant in Belgium of all the machine tools they could find. There will, therefore, be a large number of tools to

be purchased to rehabilitate the plants, and contrary to general opinion, the Belgians will have funds with which to pay for the tools. Certain Belgian manufacturers are ready to put up the necessary cash for payment of the goods, and it may be of interest to add that all the gold which was held in the National Bank in Brussels has been saved, as well as the gold in a good many other banks and is now deposited in the Bank of England in London. A number of large Belgian firms have sister firms operating either in France or other countries, which will help to restore the plants in Belgium. Also the large profits made in the Belgian Congo during the war will be of assistance.

Before the war the largest exporters of machine tools into Belgium were Germany, then America, then England and Sweden in a minor degree. No doubt, the Germans will endeavor to find means of exporting their machine tools again to Belgium after the war, but the Belgians, however, will surely devise means to exclude these machines. The Germans specialize a good deal on railroad tools.

After the war, tools of all descriptions will be in great demand by the Belgians, particularly the labor saving machinery, as labor will be scarce. There are certain classes of tools which are possibly more in demand in the Belgian market than any other country and to which the American manufacturer has not yet devoted enough attention. These are the heavy railroad tools. There were no less than 19 railroad shops in Belgium before the war, which were producing locomotives for all parts of the world, and most of the tools required for the production of these machines were supplied by Germany, who made very costly and intricate tools which were not at all well received by the workmen. Some of the railroad tools required in Belgium are of a special nature as compared with the tools used in America. For example, in Belgium freight car wheels having cast steel centers with forged steel tires shrunk on are used. Tools which must be of heavy construction must be made to make these wheels. Strong attention is drawn to this fact as boring machines, axle lathes, slotting machines, wheel turning lathes, etc., for this heavy type of work will be in demand.

There should be a very promising future for American machine tools in Belgium after the war. A report has been published in which it is stated that the Belgian government estimates that \$400,000,000 worth of tools, machinery and raw materials have been taken by Germany.

SOUTH AMERICAN SITUATION

G. E. Briggs, a representative of the National City Bank of New York at Buenos Ayres, Argentina, spoke of the export market in South America, saying in part as follows:

Germany realized the danger of abandoning the foreign markets to her competitors and prior to the struggle filled the custom houses of South America with merchandise evidently calculated to supply the demands of those countries for the duration of the war. Today, after three years of war, German products are still obtainable in South America. The grasp which Germany had on the South American trade was so strong that a large proportion of the merchants say frankly that they are waiting impatiently for the moment when they can resume their satisfactory trade with Germany.

ARGENTINE.—While the Argentina is purely a cattle and agricultural country, there is a considerable importation of machine tools for use in the government and railroad shops. However, as 75 per cent of the railroad mileage of the Argentine is owned by English capital, 14 per cent by the state and 11 per cent by French companies, most of the supplies are purchased through London and Paris. Prior to the war 75 per cent of the machine tools imported, exclusive of those for the use of the English railroads, were of German manufacture. The Germans have adapted their machines to various uses such as in a lathe, by providing a deep gap in the bed which will accommodate work of 80 cm.

in diameter, whereas a lathe of the same size without the gap would admit of work with a diameter of only 30 cm.

The majority of the American tools in the Argentine are in the shops of the English railroads and have been purchased by the London offices of those railroads from the English offices of the American manufacturers. Only a few American machines are in the government shops and still fewer are in the smaller industries.

CHILE.—A favorable market exists in Chile. The principal users of machine tools are the government, and when I mention the government I include also the railroads, which are all state owned, and the mines. The government shops are largely equipped with American machine tools at the present time. A great establishment is now being built there by an American concern, to construct locomotives for the state roads. The Chilean government and Administration of Railroads usually buy their supplies through houses in Chile. Occasionally, however, at a time like the present, when they are encountering the greatest of difficulty in obtaining supplies, they send a commission to a European or to the American market. A commission of five or six young men has come from Chile to the United States to study the American railroad system. They intend to spend two years in this country, and it is expected that they will be the ones to dictate the Chilean railroad policy of the future.

OPPORTUNITIES IN RUSSIA

R. Poliakoff, assistant professor of mechanical technology, Technical Institute, Moscow, Russia, and a member of the Russian Purchasing Commission in the United States, spoke on Russia as a market for American machine tools. He said, in part, as follows:

Russia became acquainted with American machinery many years before the war broke out and has learned its value and has acknowledged its superiority as compared with similar products of other countries. In the last two or three years preceding the war, the importation of machinery to Russia amounted to approximately \$4,000,000 to \$5,000,000. Of this about \$1,000,000 came from the United States, the same amount from England and the rest from Germany. While there cannot be the slightest doubt that in most cases the German machine tools were of inferior quality, they, however, served the purpose quite satisfactorily, supplying the ordinary user with a cheaper machine.

It is noteworthy that the types of German machinery were, so to say, inspired by the United States products and in many cases they were an imitation. As an example, a bolt and rivet forging machine of certain size, which is classified by the American manufacturer for making rivets up to 1 in. diameter, was copied by a German manufacturer who specified that it is capable of producing rivets up to 1¼ in. or even 1½ in. in diameter and so he was able to produce a machine which was considerably cheaper than the American machine of the 1½ in. capacity. If the machine became injured, the operator was held at fault. There is not the slightest doubt that the demand for machine tools in Russia after the war will be very great. All of the rehabilitation of the region, the devastation of which was so thoroughly attended to by the Germans, will have to be carried out as quickly as possible when peace permits. Whatever conditions exist now in Russia, which are not as hopelessly bad as they are pictured by some sensation seeking newspapers, the country is undergoing a process of regeneration and reconstruction which will require machine tools. Machine tools are helping and will help us to win the war; machine tools will help us after the war, when we shall want them perhaps even more than now to improve our living conditions.

There is not the slightest doubt that Russia can be a good market for American machine tools after the war, and in order to avail themselves of this market the American

manufacturers will have to be interested in it and see that they are properly represented by reliable parties.

FRANCE A HEAVY IMPORTER OF TOOLS

Roger P. Redier spoke on the machine tool situation in France. An abstract of his remarks follows:

Approximate figures of import of machine tools to France by America, Germany and England, the three principal importers, for a period of five years before the war show a yearly average of \$2,283,000. The imports of machines from America alone to France for the last three years amount to \$50,126,807, or \$16,708,935 yearly. These figures at first sight are enormous, but if it is considered that the machines have been run to their utmost capacity and 24 hours a day with only the most urgent repairs being given them, the above sum should be divided by three to give a more comparative figure.

The fact that French manufacturers are very conservative and do not scrap machines, but repair them and use them over again, does not present a very favorable outlook for after the war business. However, the condition of France after the war will be such that there will be a large demand for labor saving machinery, and France will be an altogether different nation industrially. The industries that will have to be rehabilitated and the new industries that will develop will require the aid of America and of American machinery. France will have to rebuild and re-equip her destroyed factories, rebuild her rolling stock and her merchant marine. All this will demand machine tools.

After the war there will be two classes of machine tool buyers, the ones that have been engaged since the beginning of the war in manufacturing war materials and the others, less fortunate, whose factories have been destroyed or closed during the struggle. The first, although they will require machine tools of certain type to stabilize their regular manufacture, will not be for a little while what we call heavy buyers. The other class will require the most attention and there is no doubt that in order to re-start their business they will require easy terms of payment.

There are good reasons to believe that the machines purchased by the American government for export to France for military purposes will never come back and will be sold on the spot after the war, which might create at that time a little disturbance in the market.

RAPID DEVELOPMENT IN SPAIN

Henry S. Moos, of the American Machinery Syndicate of New York and Spain, spoke on the machine tool situation in Spain. He spoke, in part, as follows:

Industrial life in Spain has now reached a degree of activity never known before, and that country is beginning to take a more prominent position in the world's market of machine tools than heretofore.

At the beginning of 1916 Spain possessed 8,700 miles of railroad track and heavier locomotives have now been acquired. A prominent industry in Spain is the railway and tramway car building industry. There are five factories in Spain, two of which are very important. The largest plant is located near the French frontier and is manufacturing its own axles, tires and wheels and is turning out thousands of railroad cars per year. A new corporation has just been formed for the manufacture of railroad equipment, cars, tires, locomotives, forgings, etc., and one of the engineers of this concern is at the present time in the United States studying conditions with a view of purchasing several hundred thousand dollars' worth of machinery.

In view of the difficulties which a number of Spanish manufacturers have experienced in securing machine tools during the period of 1914 to 1915 from the United States, an entirely new industry has been created in Spain. Be-

fore the war practically no machine tools were produced there. Today, there are at least 20 firms, some of them employing as many as 500 and more men engaged in the manufacture of a wide range of machine tools, principally upright and sensitive drilling machines, screw cutting lathes, engine lathes, planers, shapers, etc. New factories are sprouting up like mushrooms and the continuous development of Spanish industrial life must necessarily create an ever growing demand for new and additional equipment to keep and start industries going. The opportunity for American manufacturers to obtain a lasting foothold in Spain is greater now than it ever has been. The number of machine tools shipped to Spain in the last three years from this country alone, is probably larger than the sum total of such machinery shipped into that territory during the 20 preceding years.

WORD FROM OUR RAILWAY MEN IN FRANCE

An interesting letter from Charles Gibson Brown, Jr.,* who recently went to France with the railway regiment as lieutenant in Company E, 19th Regiment, U. S. Engineers, gives an excellent idea of what our boys are doing over there. He writes as follows, his letter having been abstracted somewhat:

"Today we started work. Owing to delays in shipment of overalls, tools and all manner of equipment, we had a busy two weeks' work getting set, but with a hundred and one typically French delays, we got off. We have taken over parts of the Paris-Orleans shops. They do not compare with those in Altoona, but they are bigger than the average Pennsylvania shops, except those at Philadelphia and Trenton, and have many American tools. The engines range from those much smaller and older than any we have to those as big as our regular freight engines or even a bit larger. Our men started in on a bit of an engine, built in 1885 in Alsace Lorraine, and now in yard service. Starting at 6:30 a. m. with one and one-half hours out for dinner, they had the engine completely dismantled by 5 p. m., ready to start repairs. The French have been in the custom of taking three or four days to get this far, from what I understand. When our men get accustomed to the work and the new system of measurements, they will do still better.

"I get up at 5 a. m. and walk to the shop. I could write for an hour on shop conditions and the many strange peoples working in them, including French women who do all kinds of work. After having been away from shop work for over four months, the clang of the boiler shop was like music. For the most part, things are much like the equipment in the American shops. The French go at the work in much the same general way, but in a much slower and more painstaking manner than we do at home. We find quite a few machines built in the United States and a number of German make. I am general foreman of the erecting and machine shops. This work covers that part of my special apprenticeship. I have 120 men under me.

"When this reaches you I will have finished my fifth month in uniform, and have not had a single regret over going into the service. Together with the other officers stationed here, I made a little trip to the country. It is a fine country; full of remains from ancient and near ancient history. The houses are built into the cliffs and we saw old city walls, ruined castles and so on.

"In any boxes you send, put in magazines, especially those full of pictures. They are most liked. The men will appreciate the Christmas box you speak of sending. Have met Captain Walker, formerly of State College. It was a sight for sore eyes to see him in the dining room when we came in for dinner."

* Mr. Brown is a 1916 graduate of the Pennsylvania State College.

RAILWAY REGIMENTS' TOBACCO FUND

Recent despatches from France have told of the splendid work being done by the nine regiments of American railway men who are now operating an important French strategic railroad. The service which they are rendering is highly important and while they do not take part in the fighting they are exposed to all the dangers of warfare. These men enjoy the distinction of being the first American soldiers to be actually under fire in the war zone in France.

As a means of showing their appreciation of what the members of the railway regiments are doing for their country, a movement has been started by persons connected with the railway supply industry to raise a "Railway Regiments' Tobacco Fund." The committee in charge of the fund is made up of F. A. Poor, president of the P. & M. Company, chairman; Samuel O. Dunn, editor of the Railway Age Gazette, secretary; E. H. Bell, president of the Railroad Supply Company and president of the National Railway Appliances Association; George A. Post, president of the Standard Coupler Company and president of the Railway Business Association; R. P. Lamont, president of the American Steel Foundries; J. M. Hopkins, president of the Camel Company; and A. C. Moore, vice-president of the Safety Car Heating & Lighting Company. John R. Washburn vice-president of the Continental and Commercial National Bank of Chicago, will act as treasurer of the fund.

The movement has the hearty endorsement of Samuel M. Felton, president of the Chicago Great Western and director-general of the military railways of the United States. It is hardly necessary to say that smoking is one of the principal means of enjoyment of the soldiers. Deprived of their usual comforts the solace which tobacco affords is almost a necessity. Anyone accustomed to American tobacco can derive little pleasure from that which is sold in France and for that reason it is necessary to send tobacco from this country, and since it is difficult to secure the delivery of shipments in bulk it must be forwarded by parcel post. Mr. Felton estimates that each of the nine railway regiments now in service will require 20 packages of tobacco of 15 pounds each, with the necessary cigarette papers, and five pounds of pipe tobacco weekly. This would make a total for the nine regiments of 2,160 pounds, which would cost approximately \$1,080 per week.

A circular letter is now being sent to railway supply concerns requesting them to subscribe \$10 a month for fifteen months from October 1, 1917, to January 1, 1919, this subscription to be terminated at an earlier date should the war end before the expiration of that period.

It is hoped in this way to raise an amount sufficient to provide "smokes" for all the members of the existing nine railway regiments.

Up to October 30 subscriptions had been received from the following companies:

Ajax Forge Company, Chicago, Ill.....(to cover 15 months)	\$150
Ajax Rail Anchor Co., Chicago.....	10 a month
American Flexible Bolt Co., Pittsburgh, Pa.....	10 a month
American Manganese Steel Co., Chicago Heights, Ill.....	10 a month
American Steel Foundries, Chicago.....	10 a month
Bronze Metal Co., New York, N. Y.....	10 a month
Buckeye Steel Castings Co., Columbus, Ohio.....	10 a month
Bucyrus Co., South Milwaukee, Wis.....	10 a month
Buda Company, The, Chicago.....(to cover 3 months)	30
Camel Co., Chicago, Ill.....	10 a month
Dilworth, Porter & Co., Pittsburgh, Pa.....	10 a month
Economy Invert Co., New York, N. Y.....	10 a month
Haskell & Barker Car Co., Chicago, Ill.....	10 a month
Imperial Appliance Co., Chicago.....	10 a month
Independent Pneumatic Tool Co.....	10 a month
Interstate Iron & Steel Co., Chicago.....	10 a month
MacRae's Blue Book, Chicago.....	10 a month
Madden Co., Chicago, Ill.....	10 a month
Morden Forge & Crossing Works, Chicago (to cover 3 months)	30
Mare Jones Brass & Metal Co., St. Louis, Mo.....	10 a month
Mudge & Co., Chicago.....	10 a month
Ohio Injector Co., Chicago.....	10 a month
Okonite Co., New York.....	10 a month
Paxton-Mitchell Co., Omaha, Neb.....	10 a month
Pennsylvania Tank Car Co., Sharon, Pa.....	10 a month
Poole Brothers, Chicago.....	10 a month
Premiercast Co., Marton, Ohio.....	10 a month
Pyle-National Co., Chicago, Ill.....	10 a month

P. & M. Co., Chicago, Ill.....	10 a month
Q & C Co., New York.....	10 a month
Railroad Supply Co., Chicago, Ill.....	10 a month
Railway Age Gazette, New York, N. Y.....	10 a month
Railway Review, Chicago, Ill.....	10 a month
Railway Steel-Spring Co., Chicago.....	10 a month
Roberts & Schaefer Co., Chicago.....(to cover 15 months)	150
Ryan Car Co., Chicago, Ill.....	10 a month
Safety Car Heating & Lighting Co., New York, N. Y.....	10 a month
Sargent Co., Chicago, Ill.....	10 a month
Sellers & Co., Wm., Philadelphia, Pa.....	10 a month
Sherburne & Co., Boston, Mass.....	10 a month
Spencer Otis & Co., Chicago.....	10 a month
Standard Coupler Co., New York, N. Y.....	10 a month
Standard Forgings Co., Chicago, Ill.....	10 a month
Standard Steel Car Co., Chicago, Ill.....	10 a month
Valentine & Co., New York.....	10 a month
Vapor Car Heating Co., Chicago.....	10 a month
Whiting Foundry Equipment Co., Harvey, Ill.....	10 a month

Checks should be made payable to "John R. Washburn, treasurer," and forwarded to "Samuel O. Dunn, secretary, Railway Regiments' Tobacco Fund, Transportation Building, Chicago."

A MESSAGE FROM THE TRAVELING ENGINEERS

At a meeting of the executive committee of the Traveling Engineers Association, B. J. Feeny of the Illinois Cent. and president of the association, addressed the members pointing out the duty of the traveling engineers in this world war, saying in part as follows:

"It is well for us to remember that the railways are going to have their hands full to give the necessary service. As employees we are asked to give the best of our talent and energy, as well as suggestions for bettering conditions that come to our attention. The Nation wants our co-operation. Let us all be Americans—both in fact and name.

"While much has been done by the members of this association, I wish to remind you what can be done in the way of greater assistance to the Council of National Defense. The conservation of fuel is one of the most serious problems confronting the Government and the railways today. Many railways have already organized departments for supervising the handling and performance of locomotives. With the cost of fuel as great as it is now, the most rigid economy should be practiced and to this end enginemen must be thoroughly trained—they must be shown how to get the most out of every pound of fuel fired. The only way to do this is by supervision. It will therefore be necessary for the traveling engineer to give the closest attention to firing methods and inspection of idle engines under steam, with a view of reducing to a minimum the consumption of coal. It is of great importance that locomotives be loaded to their full capacity. This not only helps to relieve the congestion, but more work will be obtained from available power.

"The modernizing of old locomotives will require a great deal more attention with a view to bringing them up to maximum efficiency. In modernizing old locomotives we must equip them to take the place of new ones that can be built in time. We are now in position where all locomotives and all men must do more than ever.

"The traveling engineer, from his past experience as a locomotive engineer, can prove very valuable to the railways in co-operating with the operating department. It is therefore up to us to take counsel together and see if we cannot help reduce the cost of fuel and make more perfect the transportation chain."

Action was taken by the executive committee on both this and next year's work. It was decided to publish the reports of the committees who have prepared them for the annual meeting which should have been held in September but was postponed on account of war conditions. New subjects were selected for consideration by the association for next year. A committee was appointed to offer their services to President Willard, Chairman of the Railroad Department of the National Board of Defense. The next meeting will be held September 10, 1918, at Chicago.

USE OF PULVERIZED COAL IN BRAZIL

This Method of Burning Coal Has Made Available Quantities of Brazilian Fuel for Railroad Purposes

AS much as the railroads and industries in this country are suffering from the present fuel situation, the problem is insignificant when compared with that of Brazil. With about 500,000 square miles of territory containing deposits of coal which can be easily mined and transported to the industrial centers, Brazil has been forced

ordinary grates is impossible. The analysis of the coal is as follows:

Moisture	from 2 to 8 per cent
Sulphur	from 3 to 9 per cent
Volatile	from 14 to 28 per cent
Fixed carbon	from 34 to 58 per cent
Ash	from 26 to 30 per cent

The relatively high volatile and carbon content make it very desirable for fuel if it can be burned successfully.

The Brazilian fuel situation is of national importance and has a direct bearing on the political situation. Several extensive and expensive investigations have been made to find a means for successfully using this fuel, but until 1915 the problem remained unsolved. At that time an article appearing in the Railway Age Gazette describing tests made by the Locomotive Pulverized Fuel Company of New York, with pulverized coal on locomotives, was called to the attention of the government by the director of the Central Railway of Brazil, Dr. Miguel Arrojadé Lisboa. This method of burning fuel not having previously been considered in connection with the Brazilian coal, Dr. Joaquim de Assis Ribeiro, chief of traction of the Central Railroad of Brazil, was sent to this country to make an investigation. The possibilities of this method were so apparent that 50 tons of Brazilian coal was shipped to this country for tests on the pulverized fuel burning locomotives. These tests proved so satisfactory that in May, 1916, Dr. J. J. da Silva Freire, sub-director and locomotive superintendent of the Central Railway of Brazil, came to this country for further investigation, paying particular attention to the method of using pulverized fuel in both locomotives and stationary boilers.

As a result of the second investigation the Central Railway of Brazil decided to install a pulverized fuel preparing plant, having a capacity of 15 tons per hour, to be used for steam locomotives and stationary boiler equipment at shops located at Barra do Pirahy, which is about 65 miles north

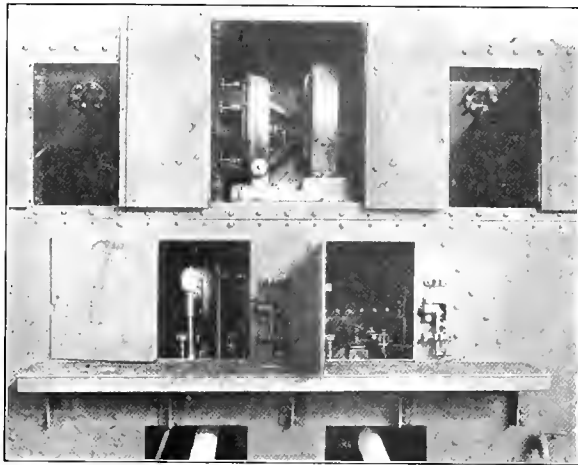

View of the Front End of the Tender Showing the Distributing Machinery

to import this material from Europe and America because of the fact that up to the present time it has been found impossible to burn the domestic coal successfully. In 1915 there was imported 1,346,147 metric tons, 561,150 of which came from America. The price of this coal has more than doubled on account of the war, the average price now paid

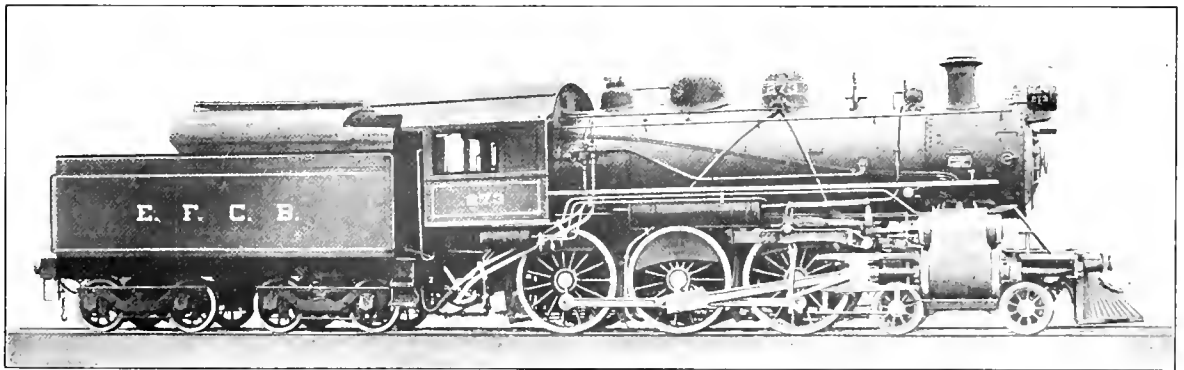

Pulverized Coal Burning Locomotive for the Central Railway of Brazil

being about \$40 per ton. Even at this high rate Brazil has been unable to obtain more than 75 per cent of its requirements.

The difficulties encountered with the use of Brazilian coal are due to the large amount of sulphur and iron pyrites contained in it, which combined with the ash forms such a large amount of clinker that efficient combustion on or-

of Rio de Janeiro. The plans and specifications for this equipment were prepared by the International Pulverized Fuel Corporation, the foreign agents of the Locomotive Pulverized Fuel Company under whose direction the Brazilian pulverized coal tests were made. At the same time an order was placed for twelve 10-wheel passenger locomotives to be equipped with that company's pulverized fuel burning

apparatus. These locomotives were built by the American Locomotive Company.

The ground was broken for the pulverizing plant May 17, 1917, and the plant was placed in operation August 22. The first locomotive fired with pulverized fuel was put into service August 27 and the rest of the locomotives were put into commission at the rate of one a day thereafter. On September 9 the first run was made with the pulverized National coal. This run was made with considerable ceremony, the president of the republic riding the locomotive throughout the trip. A report of the trip from an observer is given below:

"The first official experience with our national coal pulverized was realized yesterday, September 9, on the Central Railway of Brazil, with the special train that transported Dr. Wencenslao Braz, president of the Republic of Brazil, and his staff. Locomotive 282 was attached to the president's special train at Barra do Pirahy and pulled it to Cruzeiro, a distance of 147 kilometers, or about 90 miles, the time being three hours. The trip was made with excellent results, particularly in the long stretch between Barra do Pirahy and Cruzeiro.

"During a great part of the trip the president remained

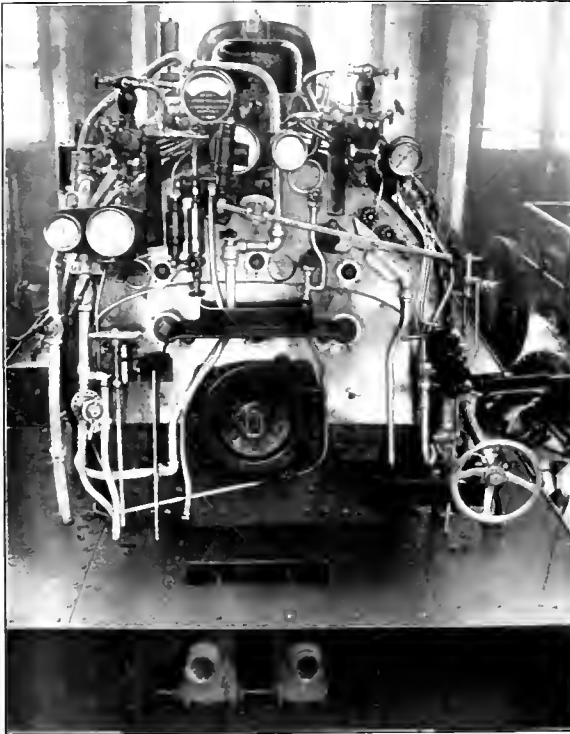

Back Head of the Pulverized Fuel Burning Locomotive with the Cab Removed

in the locomotive cab, assisting with the feeding of the firebox with the national coal pulverized in the plant recently constructed at Barra do Pirahy, the coal having come from the Sao Jeronymo mine. The president of the republic showed himself very much impressed with the calorific value of the coal and the ease and regularity with which steam pressure was maintained by the locomotive throughout the trip, and without any smoke.

"The tonnage of the train was 210, which was hauled back, the total coal used being, as well as I can estimate, about 4 tons. The running time going was three hours

exactly; the return 3 hours and 25 minutes. President Braz sent a telegram to the minister of public works, as follows: 'The fuel problems of our country have been solved.' He also sent a telegram of congratulations to Dr. Assis Ribeiro. The President and the director expressed themselves as being entirely satisfied and highly pleased at the demonstration, and also as to the simplicity of the machinery and control over the fire, which was thoroughly demonstrated while they were on the locomotive.

"On leaving the locomotive cab for his car, the President embraced effusively the engineer and fireman, and congratulated



Interior of the Pulverizing Mill

lated Dr. Aguiar Mareira, director of the Central Railway of Brazil, on the results obtained."

At the conclusion of the trip the president sent the following telegram to Dr. Traveres de Lyra, minister of railways:

"From Barra do Pirahy to Vargem Alegre I traveled on 10-wheel locomotive No. 282 fitted for the use of pulverized fuel, with excellent results. The trip was made with a velocity of 65 kilometers per hour, having a train of 210 units behind it. I take great pleasure to give you this communication, which I am certain will be received by all Brazilians interested as a solution of one of our most important national problems. Salutation.—*Wencenslao Braz.*"

With the successful use of native coal, Brazil has solved one of its most perplexing economic problems. The Brazilian government has contracted to equip 250 of the locomotive on the Central of Brazil with the pulverized fuel burning equipment during the next five years. This contract also includes the equipping of stationary boilers and industrial furnaces.

The 12 locomotives which were built in this country and sent to Brazil equipped to burn powdered fuel weigh 172,000 lb. and have a maximum tractive effort of 28,300 lb. They have a gage of 5 ft. 3 in., cylinders 21½ in. by 28 in., driving wheels 68 in. and weigh 122,000 lb. on drivers. They are equipped with firebrick arches and superheaters, have a total heating surface of 2,149.7 sq. ft. and a superheater heating surface of 428.2 sq. ft.

The illustrations show a view of the locomotive, a view of the back head of the locomotive with the cab removed, the front end of the tender containing the pulverized fuel distributing machinery and interesting views of the pulverizing plant.

FEDERAL POSTAL PROFITS.—The Post Office Department announces that the profits of the department for the fiscal year ending on June 30 last amounted to more than \$9,000,000; and that sum has been paid in to the Treasury Department as a contribution to the general fund.

CONVERTED SWITCH LOCOMOTIVES

Obsolete Twelve-Wheel Freight Locomotives Adapted
To Switching Service by Altering the Frames

BY W. H. HAUSER

Mechanical Engineer, Chicago & Eastern Illinois

THE Chicago & Eastern Illinois has an engine class containing 16 12-wheel freight engines which were built in 1897 and 1899. When these engines were placed in service they were among the largest hauling freight. The size of freight equipment has increased so greatly, however,

simply by removing the engine truck and the rear pair of drivers. In the case of our 12-wheelers, however, this conversion had never been considered as the engines were not designed to permit proper weight distribution if this simple plan of conversion were followed. It was found neces-



Fig. 1—The Twelve-Wheel Locomotive Before Conversion

that for some time past these 12-wheelers have been relegated more and more to odds and ends of service, with their obsolescent day fast approaching. More recently they frequently have been used in a sort of semi-switching and road service but not with entire success due to their long rigid wheel base. They are well built engines, however, except for

sary to change the wheel spacing in order that the proper wheel loads might be obtained.

Figs. 1 and 2 show one of these engines before and after conversion. It will be noticed that the converted 6-wheel switcher is in general a better looking engine than the original 12-wheeler. Many of the characteristics of the en-

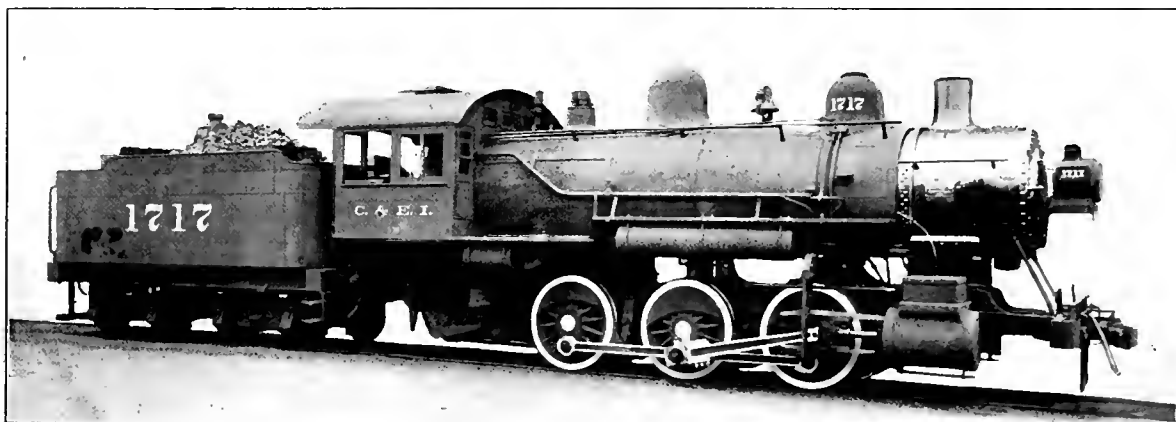

Fig. 2—The Six-Wheel Switcher After Conversion

the type of fire-box, which is of the O-G type very narrow and 10 ft. 6 in. long.

On account of growing need of switch power it was proposed to change some of these 12-wheelers to 6-wheel switchers. The idea of converting freight engines with four pair of drivers and an engine truck to 6-wheel switchers is not a new one as it has been practised by other roads where the engines were so designed that the change could be made

engines are similar as is to be expected, but some of the more important are quite dissimilar as will be noted below:

	Before conversion, 12 wheeler	After conversion, 6 wheel switch
Service	Freight	Switch
Traction effort	35,400 lb.	35,400 lb.
Weight in working order.....	175,500 lb.	160,660 lb.
Weight on drivers.....	144,050 lb.	160,660 lb.
Weight on leading truck.....	35,050 lb.
Weight of engine and tender in working order	292,300 lb.	263,160 lb.

	Before conversion, 12 wheeler	After conversion, 6 wheel switch
Wheel base, driving.....	15 ft. 6 in.	12 ft.
Wheel base, total.....	25 ft. 2 in.	12 ft.
Wheel base, engine and tender.....	54 ft. 7 in.	45 ft. 2 in.
Weight on drivers ÷ tractive effort.....	3.96	4.53
Simple cylinders, diameter and stroke.....	21 in. by 26 in.	21 in. by 26 in.
Driver wheel diameter.....	55 in.	55 in.
Boiler, style firebox.....	O-G	O-G
Boiler, working pressure.....	200 lb.	300 lb.
Firebox, length and width.....	126 in. by 41 in.	126 in. by 41 in.
Flues, number and outside diameter.....	288—2 in.	288—2 in.
Heating surface, flues.....	2,045 sq. ft.	2,045 sq. ft.
Heating surface, firebox.....	197 sq. ft.	197 sq. ft.
Heating surface, total.....	2,242 sq. ft.	2,242 sq. ft.
Grate, length and width.....	1.6 in. by 41 in.	94 in. by 41 in.
Grate area.....	55.8 sq. ft.	26.8 sq. ft.
Tender, weight light.....	42,500 lb.	41,000 lb.
Tender capacity, water and coal.....	6,000 gal.—13 tons	5,000 gal.—10 tons

and the center line of the cylinder by 17 in. that the weight on all three pair of drivers would be very evenly divided—in fact, more evenly than is frequently the case with newly built six-wheel switchers. Below is shown a table of these weight distributions:

	Twelve wheeler, before conversion	Six wheeler, after conversion
Engine truck.....	35,050 lb.	35,050 lb.
First pair drivers.....	35,050 lb.	50,900 lb.
Second pair drivers.....	35,050 lb.	57,800 lb.
Third pair drivers.....	35,250 lb.	52,000 lb.
Fourth pair drivers.....	35,100 lb.	

Fig. 3 shows the frame of the 12-wheelers before conver-

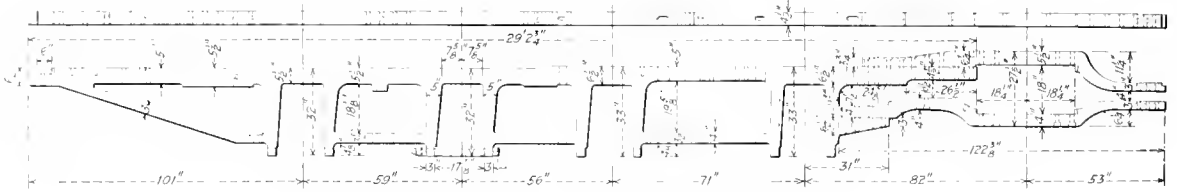

Fig. 3—The Frames of the Twelve-Wheel Locomotive Before Conversion

In converting the locomotives data covering actual or computed weights were collected for the entire engine and its various parts. A center of weight was found and the driver spacing was then sketched preparatory to a complete

conversion and Fig. 4 shows the frame as redesigned with the even distribution of weight over three pair of drivers.

The method followed in changing the frame was quite novel and interesting. The upper and lower front frames

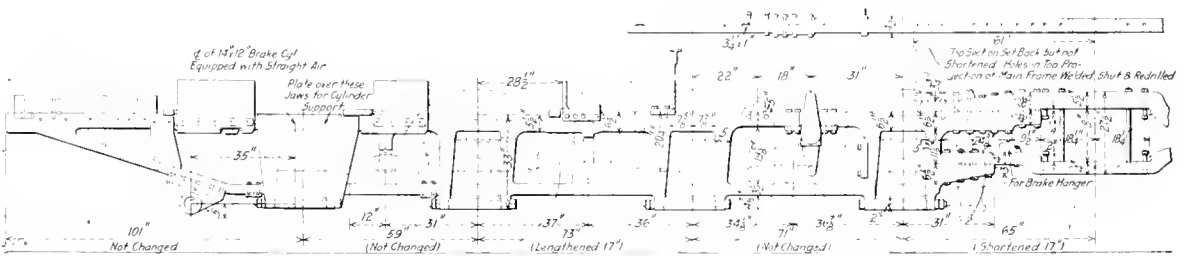

Fig. 4—The Finished Frame for the Six-Wheel Switch Locomotive

consideration of the work necessary for conversion. As a result of these computations it was found that by lengthening the distance between the second and third drivers by 17 in. and by shortening the distance between the first driver

were removed and delivered to the blacksmith shop. Six holes were plugged and welded in the blacksmith shop in the rear end of both top frames in order to match with the holes in the top front tongue of the main frame, while the

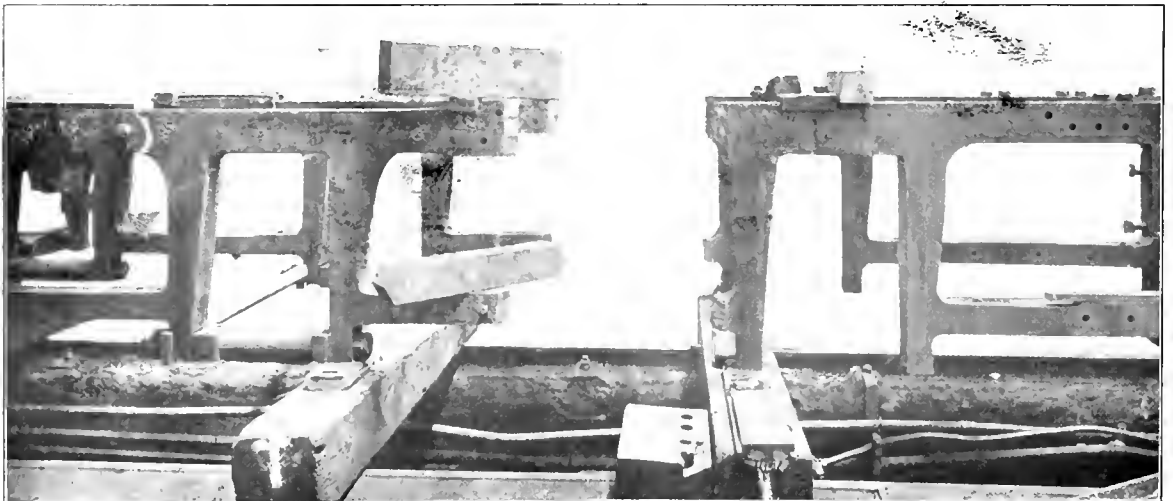

Fig. 5—The Frames Ready for Welding In the Additional Material Between the Second and Third Drivers

rear end of the lower front frame was straightened and cut off to fit as shown. The main frames were cut with the Oxweld torch between the second and third drivers and separated and 17 in. of each of the front upper main frame tongues were cut off by the same means.

Fig. 5 shows how the frames looked after the blacksmith and machine work had been completed and they were ready for welding in the 17-in. pieces between the second and third drivers. These pieces were welded in with the Oxweld torch. The finished job had a neat appearance. Cost figures covering Oxweld method of cutting and welding this frame as compared with taking down the entire frame and welding it by the blacksmith fire method are as follows:

Cut and weld with Oxweld \$117	Taken down, cut, weld and replace by Blacksmith Fire Method \$386
-----------------------------------	---

There are other minor items in connection with the change in the design of the locomotives such as a new and heavier guide yoke brace and a new cast steel guide yoke. The main rods were shortened 17 in., while the side rods between the

second and third drivers were lengthened 17 in. The spring rigging had to be altered but to offset this was the salvaged old springs and the fact that repairs and renewals would have been necessary with the old spring rigging anyway. When the first engine was placed in service it was found that owing to the size of the firebox the firing had to be watched with the greatest care, in fact too closely to permit of good economical operation. The engines had always been free steamers in freight service when properly fired and now when placed in switch service they became too erratic. After a few trials this trouble was overcome by disconnecting and laying firebrick over three of the front grates and building a wall 27 in. high at the rear end of these brick. Since five converted engines have operated with great success and the others are to be converted as conditions permit.

The total cost of the extra work attendant on converting a single engine and over and above the general repairs and credits obtained for material removed was approximately \$450. The converted engines have been very successful in service both from a mechanical and operating standpoint.

PREVENTION OF LOCOMOTIVE SMOKE*

The Effect the Brick Arch Has on Smoke and the Reasons Why Sufficient Firebox Volume is Necessary

BY J. T. ANTHONY †

IN the 1913 proceedings of the Master Mechanics' Association a report was made in which it was stated that a 50 per cent reduction in smoke was obtained by the use of the brick arch. The tests from which this information was obtained were made with Penn gas coal, having

Goss, formerly dean of the railroad department of the University of Illinois, was chief engineer, found that the brick arch decreases the average density of visible smoke by 33 per cent; decreases the total average quantity of cinders and fuel dust emitted in smoke by 25 per cent; decreases the amount of carbon contained in cinders and fuel dust per ton of coal consumed 24 per cent; decreases the amount of ash contained in cinders and fuel dust per ton of coal consumed 28 per cent; decreases the volume of air intermingled with gases of combustion discharged through the stack 15 per cent; increases the volume of CO₂ discharged through the stack 6 per cent; decreases the volume of CO discharged through the stack 10 per cent, and increases the evaporation per pound of coal 7 per cent. These tests were run with coal from Macoupin County, Illinois, of the following composition:

Fixed carbon	37.47 per cent
Volatile matter	38.41 per cent
Moisture	9.89 per cent
Ash	12.23 per cent
B.t.u. per pound of dry coal	12,884

Both of the above tests were run with an 0-6-0 type switching locomotive, with a narrow firebox 40 in. wide by 106 in. long, with 29 sq. ft. of grate area. The air inlet through the ashpan was 5.7 sq. ft., or 20 per cent of the grate area. The arch was 66 in. long and was supported on two arch tubes.

The final conclusions of the above test report also state that "the presence of the brick arch in the locomotive firebox increases efficiency and decreases fuel consumption, decreases the loss of heat units in smoke and ash discharged and reduces the visible smoke."

"The use of incorrect methods of firing, as indicated by the results of tests in which inexperienced firemen were employed, reduces efficiency, increases fuel consumption and fuel losses and increases smoke discharge."

Tests recently conducted on a Mikado type locomotive show smoke reductions varying from 50 per cent at low and medium rates of firing to 31 per cent at high rates; as shown by the curves in Fig. 1. The locomotive was hand-fired, using high volatile Penn gas coal screened over a

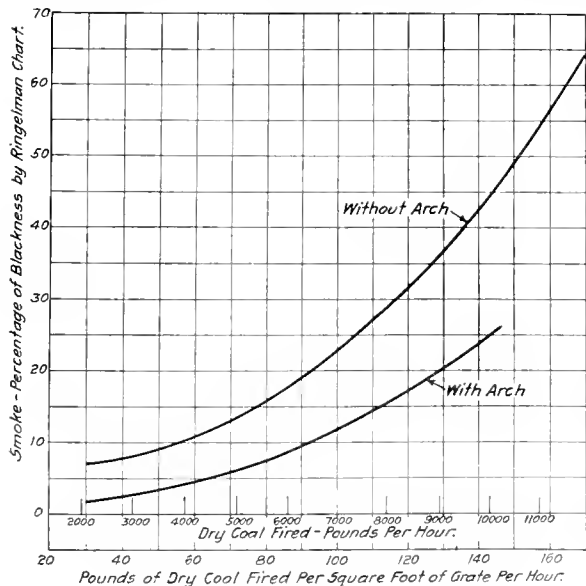

Fig. 1—Smoke Intensity Reduced by the Brick Arch

34.07 per cent volatile matter. Together with this reduction in smoke there was an increase in evaporation of 8.6 per cent due to the arch.

Later the Chicago Smoke Commission, of which W. F. M.

* From a paper read at the annual convention of the Smoke Prevention Association.
 † Assistant to the president, American Arch Company.

1½-in. mesh screen, the coal having the following composition:

Fixed carbon	54.00 per cent
Volatile matter	31.00 per cent
Moisture92 per cent
Ash	14.08 per cent
B.t.u. per pound of dry coal.....	13,088

This locomotive had 70 sq. ft. of grate area, a barrel combustion chamber 42 in. long, a 70-in. arch supported on four 3-in. arch tubes, an air opening through the ashpans of 7.80 sq. ft.—11 per cent of the grate area—and air openings in the grade of 20.21 sq. ft.—28.8 per cent of the grate area.

In these tests the increase in evaporation, due to the arch, varied from 8½ per cent to 15½ per cent. These three tests are probably the most thorough and reliable that have ever been conducted for the specific purpose of determining the effect of a brick arch on locomotive smoke abatement, and the test results are corroborated by the practical experience of railroad men throughout the country. The principal measures taken by railroads today to meet smoke ordinances consist of issuing firing instructions and equipping locomotives with brick arches.

While it is generally recognized that the brick arch will reduce the smoke emission from a locomotive, the reason therefor may not be clear. The formation of smoke is due primarily to the decomposition of the volatile hydrocarbons contained in all bituminous, semi-bituminous and lignite

with which we are familiar in furnace practice. When the various hydrocarbons are decomposed, the carbon is precipitated as a solid particle in the form of soot and these incandescent particles, floating in the flame, give it the luminous color. We are apt to think of this carbon as being set free and deposited in the form of atoms, but such is not the case. We have no knowledge of the atom existing as a unit, separate and distinct. The small particles of soot with which we have to deal are probably made up of a large number of carbon molecules. The very smallest soot particle that exists is this molecule, which consists of a number of carbon atoms (probably 12), held together by a sort of bond or attractive force of an electrical nature.

As a result the soot particles, which are the primary source of all smoke, have a very tenacious structure and are extremely difficult to break down when once formed. In order to burn them completely, it is necessary to supply a number of oxygen molecules sufficient to combine with each carbon atom, to bring them into contact with the carbon atoms at a temperature high enough to sustain combustion and to provide time sufficient for the combustion to be completed.

These conditions are similar to those met with in burning the "fixed carbon" on the grate, but are more difficult to fulfill. A piece of coke, or carbon, burning on the grate is held more or less in place until it is consumed. Combustion

TABLE I—GAS SAMPLES TAKEN AT THE TOP OF THE FUEL BED
Wt. in grams per cu. ft. of total gases at 60 deg. F and 30 in. mercury

Lb. coal fired per sq. ft. of grate per hour	Thickness of fuel bed	Total gaseous						Soot	Total soot and tar	Total combustible	Soot and tar, per cent of total combustible
		C in CO	CH ₄	H ₂	C ₂ H ₄	combustible	Tar				
22.3	6	2.034	.628	.209	.732	3.603	.528	.482	1.010	4.613	21.9
47.5	6	2.136	.142	.068	.036	2.382	.241	.369	.610	2.992	20.4
63.4	6	1.466	.215	.072	.107	1.860	.107	.215	.322	2.182	14.7
124.0	6	1.488	.018	.014	.326	1.846	.004	.016	.020	1.866	1.1
52.0	12	2.536	.484	.173	.242	3.435	.945	.477	1.422	4.857	29.3
105.5	12	2.522	.516	.241	.344	3.623	.658	.738	1.396	5.019	27.8
131.0	12	2.389	.036	.036	.036	2.497	.055	.092	.147	2.644	5.6
185.0	12	1.634	.108	.072	.036	1.850	.123	.415	.538	2.388	22.6

coals, though the presence of coal dust that is fed into the firebox and whirled out through the tubes unburned, adds to the smoke emissions.

As the name indicates, the volatile hydrocarbons are compounds of carbon and hydrogen, and are of a very complex character. The heavier compounds are driven off in the form of tar in a semi-liquid or solid state, while the lighter hydrocarbons are driven off in a gaseous state. The distillation begins at a temperature around 400 deg. F., and is completed at a temperature of 1,600 deg. F. The decomposition of the volatile matter by the action of heat takes place very readily at temperatures above 1,400 deg. F.

The exact composition of the hydrocarbons when first distilled from the coal at the different temperatures is not known, as they break down so readily under the influence of heat and are so unstable that it is impossible to collect samples for analysis. The indications are, however, that the heavy hydrocarbons when first driven off contain by weight about 85 per cent carbon, 10 per cent hydrogen and 5 per cent oxygen. Under the influence of heat, these hydrocarbons break down into carbon, hydrogen, oxygen, lighter hydrocarbons of the methane (CH₄) series, and lighter unsaturated hydrocarbons.

The hydrogen is highly inflammable and burns readily if there is an oxygen supply above the fuel bed. The lighter hydrocarbons also burn readily if the oxygen supply is sufficient. If it is insufficient the hydrocarbon is broken down by the heat into carbon and hydrogen, the hydrogen either combining with the oxygen that may be present to form water or escaping into the tubes unburned.

Carbon does not exist in a gaseous state at temperatures

is accelerated by the high temperature prevailing in the fuel bed and by the violent scrubbing action of the oxygen in the air rushing through the fuel bed.

The particle of soot resulting from the breaking down of the hydrocarbons is well on its way to the tubes at the instant of its formation. It is not brought into violent mechanical contact with a supply of oxygen, but floats along in an atmosphere that has been robbed of much of its oxygen in passing through the fuel bed. The temperatures prevailing in the upper part of the firebox are generally sufficiently high to insure ignition and combustion, but under ordinary conditions the time available for combustion varies from 1/5 to 1/10 of a second, and this is insufficient.

With the conditions that prevail in the locomotive firebox, it is easier to prevent the formation of soot than to burn it when once formed. The precipitation of soot can be prevented only by having an excess of heated air (or oxygen) above the fuel bed, and bringing this heated oxygen in intimate contact with the volatile hydrocarbons at the instant they are distilled off. Research work done by the United States Bureau of Mines indicates that the hydrocarbons are decomposed when they have traveled but a few inches from the top of the fuel bed, and if the precipitation of carbon is to be prevented the air must be introduced at the top of the fuel bed and intimately mixed with the issuing hydrocarbons.

The chief function of the brick arch in abating smoke is that of a gas mixer. By baffling and compelling all of the gases to pass through a relatively restricted area above the arch an intimate mixture of the volatile combustible with

the oxygen is insured. While the mixing of the gases at the end of the arch does not take place soon enough to eliminate smoke entirely, it has the effect of reducing the smoke emissions, as shown by the tests quoted.

In a firebox without an arch carrying a characteristic fire—that is, with a bank of green coal under the fire door, the fire gradually becoming thinner toward the front end of the grate, where the draft has possibly pulled a hole in it—the bank of green coal under the door is expelling large volumes of rich hydrocarbons. These, passing up along the top zone of the firebox, are decomposed by the heat, causing the formation of soot which either escapes at the front end as smoke or is deposited on the heating surfaces to retard the flow of heat. At the same time a large excess of air is rushing through the thin portion of the fire on the front of the grate, and is passing directly into the lower tubes without in any way aiding the combustion of the hydrocarbons liberated in the back of the box and very often causing flue leaks or failures. Such conditions are not at all uncommon in locomotive fireboxes unequipped with the arch. Front end gas analyses often show a large excess of oxygen, due to the blast of air through the lower tubes, in combination with high carbon monoxide, hydrogen and hydrocarbon contents due to incomplete combustion of the volatile hydrocarbons arising from the bank under the door.

With the arch under similar conditions any excess air coming through the thin portion of the fire on the front

TABLE II—HEAT DEVELOPED IN FUEL BED, AND POTENTIAL HEAT IN GASES, SOOT AND TAR

Constituent	Heat Developed in the Fuel Bed		Heat value per lb.	B.t.u. per cu. ft. gas
	Wt. grams per cu. ft.	Wt. lb. per cu. ft.		
C in CO	2.136	.00471	4,500	21.2
C in CO ₂	1.546	.00341	14,500	49.5
Total				70.7
Potential Heat in Gases, Soot and Tar				
C in CO	2.136	.00471	10,000	47.1
CH ₄	.142	.000313	24,000	7.5
H ₂	.068	.000149	62,000	9.3
C ₂ H ₄	.036	.000079	21,600	1.7
Soot	.369	.000813	14,500	11.8
Tar	.241	.000531	16,000	8.5
Total				85.9

of the grates is heated up, deflected and forced back over the end of the arch, where it is mixed with the gaseous combustibles arising from the green coal under the door. A heavy bank of green coal restricts the flow of air at the point where it is most needed and at the time when it is most needed—with the result that most of the hydrocarbons are broken down and the carbon precipitated before being brought into contact with the oxygen entering through the front grates. With the ordinary type of firebox the combustion chamber space and the flamework are insufficient to give all the particles of soot and combustible gas time to burn before reaching the tube sheet, but such a mixing as the arch affords results in a material reduction of the smoke, and under moderate rates of firing will result in almost complete combustion of the combustible gases.

A light level fire should be carried, if smoke is to be reduced to the minimum. With the fuel bed maintained in this condition by a "scatter" type of firing, a uniform air supply is obtained throughout the fuel bed as well as a uniform distillation of the hydrocarbons. This facilitates the mixture of the oxygen and the hydrocarbons from the time they leave the top of the fuel bed, the arch mechanically accelerating this mixture.

Some authorities state that the decomposition of the hydrocarbons is caused by heating them up with an insufficient air supply and then bringing them in contact with the cooler heating surfaces or a draft of cold air. While later evidence tends to prove that this decomposition is caused

entirely by heat, shafts of cold air through the firebox are objectionable—both from the standpoint of combustion and of boiler maintenance.

It is evident from the foregoing that the arch is not in itself sufficient to prevent smoke. Intelligent firing is also necessary. Smokeless firing and intelligent firing are almost synonymous, although there are conditions under which smokeless firing is impossible, regardless of the care and intelligence exercised by the fireman.

In some quarters there has been prevalent an idea that smoke was mainly a nuisance, and that the emission of dark clouds of smoke did not signify any appreciable heat loss. As a matter of fact, the emission of smoke not only indicates bad furnace conditions, but in many cases the soot and tar escaping as smoke may contain from 10 to 15 per cent of the heat value of the coal, and this will account for a considerable portion of our "unaccounted-for" heat losses.

Tests conducted by the United States Bureau of Mines (see Technical Paper 137) showed that when burning Penn gas coal as high as 32 per cent of the combustible arising from the fuel bed is accounted for in the soot and tar which is the source of smoke.

Table I, which is taken from the bulletin mentioned above, shows the composition of gases arising from the fuel bed and the percentage of the soot and tar therein contained. It is evident from these figures that the fuel bed acts chiefly as a gas producer, and a large part of the latent heat contained in the coal is liberated by the burning of combustible gases in the combustion space provided above the fuel bed.

For a specific example, take the second case shown in Table I, where 47½ lb. of coal are burned per sq. ft. of grate per hour, with the fuel bed six inches thick.

Table II shows in lb. per cu. ft. of gas the weights of the different gases leaving the fuel bed, the heat value per pound and B. t. u. per cu. ft. of gas. The gas has a total heat value of 156.6 B. t. u. per cu. ft., of which 70.7 B. t. u., or 45 per cent, are developed in the fuel bed and 85.9 B. t. u., or 55 per cent of the total heat contained in the coal, are developed by the burning of the combustible gases above the fuel bed.

The tar and soot shown in the foregoing table contains 12 per cent of the heat in the coal. If one-half of this were to escape unburned as smoke, the resulting heat loss would be six per cent; and such losses are constantly occurring.

The amount of heat developed by the gases burning above the fuel bed will serve to illustrate the importance of firebox volume and combustion chamber space, and will also explain why intelligent firing with the use of a brick arch is not always sufficient to prevent smoke. The ordinary firebox in service to-day has not volume and combustion chamber space sufficient to provide the time element that is essential for the complete combustion of volatile hydrocarbons and the total elimination of smoke. This deficiency has been recognized by some of our railroads and during the past few years many fireboxes have been provided with combustion chambers, particularly in locomotives of the 2-10-2 and Mallet types, but combustion-chamber engines are few, when compared with the total number of locomotives in service.

It is also probable that we have been too conservative as to the length of combustion chambers that have been installed. Tests indicate that an 18-ft. or 19-ft. tube is sufficient to reduce the front end temperatures to a normal figure. Tubes of this length, when used in conjunction with a firebox of ample grate area and long combustion chamber, result in a boiler design that gives both high efficiency and high capacity.

Fig. 2 shows a type of combustion chamber that is being

used successfully in oil-burning service on some 2-10-2 type locomotives. This firebox has a combustion chamber 41½ in. in length between tube sheet and bridge wall, firebox volume of 435 cu. ft., and an average flame path of 19 ft.

With a fuel oil containing 85 per cent carbon, nine per cent hydrogen and six per cent oxygen, weighing 7.43 lb per gallon, having a heat value of 18,878 B. t. u. per pound, it was found that one square inch of air opening in the pan per gallon of oil burned per hour was sufficient to obtain

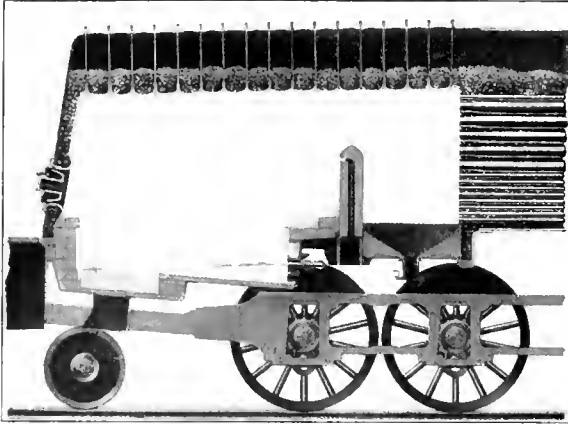

Fig. 2—Gaines Wall Applied to an Oil-Burning Locomotive

complete and smokeless combustion, even when burning 4,000 lb. of oil per hour. At this rate of combustion, an indicated boiler efficiency of 85 per cent was obtained with the Gaines wall in place. With the wall removed the boiler efficiency was 74 per cent, or a difference of 13½ per cent in favor of the wall. With the wall removed, at a rate of combustion of 4,000 lb. of oil per hour, there was a very noticeable increase in the amount of smoke emitted. This serves to show the need of a baffle or some sort of mechan-

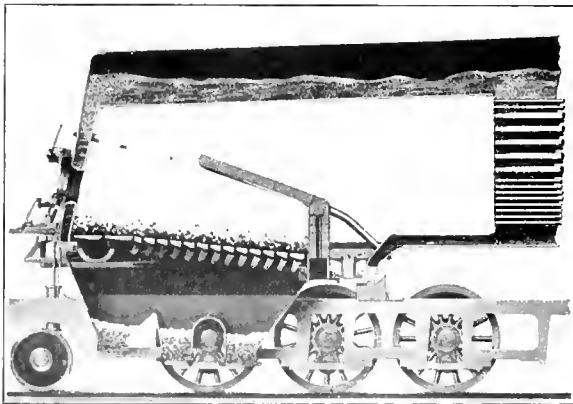

Fig. 3—Combination Combustion Chamber and Gaines Arch

ical mixing device that will insure the thorough mixture of the air with the combustible gases.

For coal-burning service, a modification of the above design is being used most successfully on several railroads. This combination of the bridge wall with air ducts through the wall admitting a secondary air supply above the fire is known as the Gaines Locomotive Furnace. Here an attempt has been made to increase the firebox volume and flamework by reducing the tube length and installing a combustion chamber between the bridge wall and the tube sheet. This

firebox has obtained some of the results desired, but for high volatile coal burned at high rates of combustion the combustion chamber space is too limited.

Fig. 3 shows a Gaines furnace in combination with a barrel combustion chamber. Here additional firebox volume and flamework have been obtained by materially increasing the length of the combustion chamber and, as this particular design was used on Mallet engines, this result was obtained without unduly shortening the tubes.

Fig. 4 shows a Gaines furnace installation in the same size firebox, with the barrel combustion chamber eliminated. This firebox has a grate area of 90 sq. ft. and more than 400 sq. ft. of firebox heating surface, with an effective volume of more than 500 cu. ft. The average length of flamework or gas passage is 15 ft. and the over-all length of the firebox is 18 ft. 3½ in. This represents the latest endeavor to secure adequate firebox volume and flamework.

While the results obtained from this type of furnace have

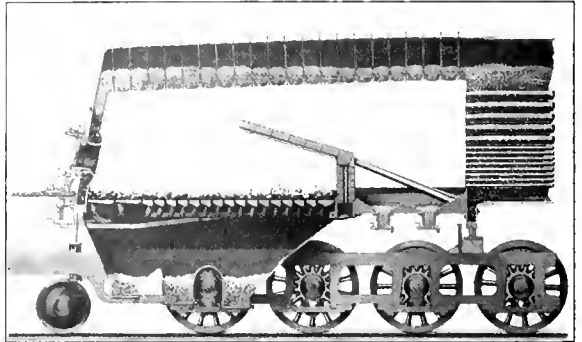

Fig. 4—Gaines Furnace with an Effective Volume of More Than 500 Cu. Ft.

proved most satisfactory, there is still room for improvement in the matter of smokeless combustion. The scientific training of firemen, the use of brick arches and the installation of combustion chambers have all tended to reduce the visible emission of smoke, but the burning of high volatile coal at high rates of combustion with the total elimination of smoke has not yet been successfully accomplished; and the indications are that some radical changes in locomotive firebox design and methods of firing coal will be necessary for the accomplishment of this object.

MECHANICAL DEPARTMENT A FACTOR IN TRAIN LOADING*

BY T. T. RYAN

Division Foreman, Atchison, Topeka & Santa Fe, Las Vegas, N. M.

The principal thing that operating officers can do to increase tonnage on single track roads is to so despatch that the freight trains will have the open door and then keep them moving. Engines and cars with bearings warmed up and lubricated will run free and pull easily, while if the same equipment is run in and out of a dozen side tracks over the division it will pull vastly harder and the cost of operation will increase. Also by their tact and methods of approach operating officers can create an esprit de corps that will automatically increase tonnage. The chief factor in increasing tonnage does not lie with the trainmaster, but with the master mechanic; we can trust the trainmaster to "hang 'em on" if we are ready to "pull 'em." There are many ways to increase the efficiency of the engines. The boilers should be kept scrupulously clean and free from scale. The effect of

*Entered in the Train Loading Competition of the Railway Age Gazette, and published in the issue of September 14.

dirty boilers and the action of scale as a non-conductor should be explained to the men. Next see that fireboxes, flues and front ends are kept free from leaks so that the draft will be unimpeded. This seems like unnecessary advice, but an examination of the 70,000 engines in the United States will disclose that it is needed.

If these things are done we will have free steaming engines. This in turn means that an engineer knows when he gets the "gate open" he can go; you cannot expect an engineer to watch a falling pointer and at the same time try to handle tonnage. The good effect of these features will be largely minimized if coal is not properly selected and sized, for there are few things more discouraging to enginemmen than poor coal and to shop men than engines which do not steam owing to irregularity in the quality of coal. Both are expensive to the railway.

If these and the minor things about the engines are done and done well when they should be, the engines in their turn will pull the maximum rating and do it every day. Then if the dispatcher will use the zeal he should in getting men over the road and *encourage them to make a good*

through the terminals with a test of about a minute per car; they get them through all right, but the road pays for it in loss of tons and in excess of coal consumption and overtime. The remedy is to see that the car is right from point of origin to destination.

LOCOMOTIVE TERMINAL DETENTION RECORDS

The demand for power is now so great that every effort must be made to keep it working effectively a maximum percentage of the time. One of the largest sources of delay is at the terminal and any means by which this delay can be analyzed and corrected will serve to increase the total locomotive supply. The Pennsylvania Railroad uses a form for gathering this information which shows the movement of a locomotive from the time it arrives at the terminal until it leaves.

The form shown in Fig. 1 is made out daily by the round-house force and includes information of interest to the transportation department, as well as the mechanical department.

M. P. 99

PENNSYLVANIA RAILROAD COMPANY

MOVEMENTS OF LOCOMOTIVES AT _____ DIVISION

FROM MIDNIGHT TO MIDNIGHT _____ 191 _____

LOCOMOTIVES ARRIVING														
LOCO NUMBER	DIVISION	KIND OF SERVICE	TRAIN NUMBER	ENGINEMEN	FIREMEN	TIME CREW IS AVAILABLE	ARRIVED AT TERMINAL	TIME FROM TERMINAL TO PIT TRACK	ARRIVED PIT TRACK	TIME FROM PIT TRACK TO ENG. HOUSE	ARRIVED AT ENG. HOUSE	TIME FROM ARRIVAL AT ENG. HOUSE TO TIME READY FOR SERVICE	REMARKS	
1	2	3	4	5	6	7	8	9	10	11	12	13	14	15

LOCOMOTIVES DEPARTING														
TRAIN NUMBER	TIME ORDER WAS PLACED	TIME ORDERED FOR SERVICE	ENGINEMEN	TIME REPORTED	FIREMEN	TIME REPORTED	TIME LOCO LEFT STORAGE TRACK	TIME LEAVING TERMINAL WITH TRAIN	TIME FROM READY FOR SERVICE TO TIME ORDERED	TIME FROM READY FOR SERVICE TO LEAVING TERMINAL WITH TRAIN	TIME FROM ARRIVAL AT PIT TRACK TO TIME READY FOR SERVICE	TOTAL TIME FROM ARRIVAL AT PIT TRACK TO TIME READY FOR SERVICE	TOTAL TIME FROM ARRIVAL AT PIT TRACK TO DEPARTURE FROM TERMINAL	REMARKS
16	17	18	19	20	21	22	23	24	25	26	27	28	29	30

Fig. 1—Daily Report for Recording the Movement of Locomotives Through Terminals

run instead of a poor run we will increase our tonnage 20 per cent without a dollar of capital outlay.

This does not, however, mean that we should not modernize old engines. First in this line come brick arches. The application of arches to all the old power would mean the equivalent of 4,000 engines added. The application of superheaters to engines not yet superheated means the equivalent of 20,000 more engines.

Did we ever hear the best engineer on our territory say the train he had last trip pulled like two trains and he could not get it going? What was the reason. Friction of course, caused by brakes sticking owing to foundation gear binding, too little shoe clearance, and dry bearings with improper area. What is the remedy? Inspect the gear and know it is right and kept so. Inspectors are supposed to get cars

This form furnishes a complete record of all locomotives arriving and departing from the enginehouse between midnight and midnight. At midnight all computations of time automatically cease and the locomotive numbers of all locomotives remaining within the enginehouse or yard territory are carried forward to the sheet for the following day and the computation of the time starts at 12:01 a. m. The time shown under the column immediately preceding the column in which the midnight time is recorded should be carried forward to the next daily sheet for information. A second form, Fig. 2, gives a daily summary of the average time the locomotives spend in passing from one point to another in the terminal.

Referring to Fig. 1, the daily detail report of each locomotive: Columns 1, 2, 3, 4, 5 and 6 are self-explanatory.

Column 7 shows the time at which the crew shown in columns 5 and 6 will again be available for service. Column 8 shows the time the locomotive and train arrive at the terminal, this time being taken from the engineman's time card or work report. In general the point at which this time is to be taken should be that at which the yard delays begin. Column 9 shows the time elapsing between the time of arrival at the terminal and the arrival of the locomotive at the pit track and is one of the items tabulated in column A (Fig. 2) of the summary. In case midnight intervenes between the time the locomotive arrives at the terminal and the time it arrives at the pit track, the time in column 9 is computed to midnight and the locomotive number and the time shown under column 8 are carried forward to the sheet for the following day. Column 10 shows the time that the locomotive arrives at the pit track or other points at which the engine crew is relieved, this time to be noted by the engineman on his work report. Column 11 shows the time elapsing between the arrival of the locomotive at the pit track and at the enginehouse or the point at which the repairs are to be made and is the difference of the time shown in columns 10 and 12. Column 11 is shown in Fig. 2, the summary, as column B. The same rules apply regarding midnight

difference between columns 14 and 18. This is shown in column D, Fig 2, of the daily summary. Column 26 shows the time between the time the locomotive is ready for service and the time it leaves the terminal with its train. This time is shown in the summary sheet under E. Column 27 shows the time the engine has spent in the hands of the mechanical department from its arrival at the pit track to the time it is ready for service, or, in other words, the time elapsing between that recorded in columns 10 and 14, or, again, the sum of the computed time shown under columns 11 and 13. This information is shown in column E on the daily summary, Fig. 2. Column 28 shows the time the engine is at the terminal for which the transportation department is responsible, it being the sum of the time shown in columns 9 and 26. This information is shown in the daily summary sheet under column G. Column 29 shows the total time the locomotive spends in the terminal which is equivalent to adding the computed time shown under columns 27 and 28 of Fig. 1, or columns F and G in Fig 2.

By this means the movement of each locomotive and the average movement of all locomotives through a terminal are readily determined. The performance may be analyzed and the work of various terminals checked. Conditions, of

AVERAGE MOVEMENT OF ROAD FREIGHT LOCOMOTIVES..... DIVISION. AT.....ENGINEHOUSE.										
MONTH OF....., 1917.										
Date	Number of Locomotives Despatched	Column 9	Column 11	Column 13	Column 25	Column 26	Column 27	Column 28	Column 29	Remarks.
		A	B	C	D	E	F	G	H	
		Hrs. Mins.	Hrs. Mins.	Hrs. Mins.	Hrs. Mins.	Hrs. Mins.	Hrs. Mins.	Hrs. Mins.	Hrs. Mins.	
1										
2										
3										
30										
31										

Notes:
 Column 9 Letter A—Time from Terminal to Pit Track.
 Column 11 Letter B—Time from Pit Track to Enginehouse.
 Column 13 Letter C—Time from Arrival at Enginehouse to Ready for Service.
 Column 25 Letter D—Time from Ready for Service to Time Ordered.
 Column 26 Letter E—Time from Ready for Service to Leaving Terminal with Train.
 Column 27 Letter F—Time from Arrival at Pit Track to Ready for Service.
 Column 28 Letter G—Total Time from Arrival at Terminal to Arrival at Pit Track, Plus Time from Time Ready for Service to Departure from Terminal.
 Column 29 Letter H—Total Time from Inbound Terminal to Departure from Outbound Terminal.

Fig. 2.—Summary of Average Movement of Locomotives Through Terminals

as before described. Column 13 shows the time elapsing between the time the locomotive arrives at the enginehouse (column 12) and the time it is ready for service (column 14). This information is shown in column C in the summary. The use of column 15 is obvious.

Where a locomotive arrives at an enginehouse and is to be sent to the shop, it is to be dropped from the daily report sheet after the time shown under column 12, and locomotives arriving at a terminal from the shop begin their record on the daily sheet at column 12. Where locomotives remain at enginehouses for heavy repairs, a record of the repairs to be made is noted on each daily report. The time in column 13 may or may not be kept separate for locomotives requiring over 24 hours for repairs and separate averages computed as between locomotives requiring under 24 hours for repairs and those requiring more than that.

Columns 16 to 23 are self-explanatory, column 23 being the time at which the locomotive and crew leave the enginehouse territory. Column 24 shows the time that the locomotive and train clear the terminal yard for freight trains, or the time the train leaves the terminal for passenger trains. Column 25 shows the time between the time the locomotive was ready for service and the time it was ordered, being the

course, will vary at different engine terminals, which makes the comparison of one terminal with another difficult; but where a locomotive seems to spend too much time either in the hands of the mechanical or the transportation department, a positive record of just what has transpired is at hand and opens the way for a satisfactory investigation. This information is usually gathered by the clerk at the roundhouse who keeps the enginemen's reports. At large terminals, separate sheets may be used for locomotives in each kind of service, such as passenger, freight and work or shifting. Each daily report is in the hands of the superintendent of motive power early the next morning with the averages determined, so that he is able to get a general idea of each terminal under his jurisdiction.

COMPOUND FOR RAWHIDE PINIONS.—Ordinary hydrocarbon oil is most destructive to rawhide pinions, and the fact that rawhide pinions have gained a bad name is entirely due to the use of this lubricant. One of the best compounds for rawhide pinions is given in Marine Engineering of Canada as follows: Plumbago, 15 per cent; resin oil, 55 per cent; resin, 30 per cent. Cloth and paper pinions can be lubricated without injury with ordinary oil.



GAR DEPARTMENT

RECLAIMING CAR MATERIAL ON THE ROCK ISLAND

A systematic campaign to secure the reworking of all serviceable material removed from cars or picked up along the tracks has been carried on for sometime on the Rock Island Lines. As a result the reclamation of material has been developed to a degree that was hardly thought possible when the project was started. Until about two years ago reclamation work was carried on almost entirely at the large shop points. A plan has been devised for taking care of as much of the work of reclamation as can profitably be handled at the points where the scrap originates.

In this way considerable freight and handling has been



Reclaimed Roofing, Siding and Decking Ready for Use

saved on some of the material that can be reclaimed without special equipment. The foremen of all shops were asked to prepare statements showing what material was being reworked and the parts made from scrap. These statements were combined in a single list, which was sent to all master mechanics and shop foremen, with the request that they furnish monthly statements of additional material which had been reclaimed. Many new uses for scrap are constantly being found, and from time to time new lists are sent out.

One of the most interesting features of the work is the large number of uses which have been found for scrap wood. Old car sills are sawed up to make sills for steel cars, sub-carlines on inside roof cars, sill splices, nailing stringers, posts and braces, purlines, grain strips and roof saddles. If all the sills cannot be used for these purposes, they are made into fence posts or stringers for building purposes. Old draft timbers are also used to make fence posts as well as dirt car stakes, ice tank crossties and grade stakes. Braces are cut off and used on lower cars or converted into cripple posts or dirt car stakes. Old siding and lining is cut off and used for smaller cars and for the short siding in doorways and around windows and cupolas of

caboose cars. Part of it is cut up for roof boards, stock car end lining and insulation for refrigerator cars.

Old flooring is used for flat, coal and ballast car floors by splicing, for dump car doors and for stock cars. Running boards are used for stock car end linings and for latitudinal running board extensions. Coal car side planks are cut up for end planks, for grade stakes, nailing stringers and purlines. Sub-sills are used to make running board saddles and stock car braces. Carlines are used for refrigerator ice bunker reinforcing.

Some novel uses have been found for metal parts removed from cars. Arch bars are made into carrier iron, brake levers, striking plates, tie straps and switch engine foot board brackets. Drawbar yokes are also used for many of these parts. Bottom arch bar straps are used for door shoes on box cars, and for corner bands. Door rails of Z bar section are used for reinforcing doors, while stock car door tracks are formed into scrap for draft lug castings. Grab irons which cannot be used again are made into cellar bolts and brake beam safety chain hooks. Old sill steps are made into pipe clamps, running board brackets and uncoupling rod brackets. Scrap truck tie straps will make three dead lever fulcrum plates.

The monthly reports serve to sustain interest in the re-



Shop in Which Lumber is Reclaimed

clamation work and methods have been found for using many parts which ordinarily would have been scrapped without being given a second thought. Scrap coil springs are now made into pinch bars and clawbars, while flat springs are used for making wrenches. Coil springs of $\frac{1}{2}$ in. and $\frac{5}{8}$ in. diameter stock are made into packing irons and hooks. Body bolsters of the built up type with the filler casting broken out of the center are reclaimed by applying pieces of channel iron from scrap truck channels. Discarded roof sheets are worked over to make smaller sizes and are also used for stove pipes, smokejacks, stove bases and drip pans. Refrigerator hair felt is reclaimed to be

used as padding for hatch plugs. Even the salt removed when repairing refrigerator cars is utilized, as it has been found very satisfactory for thawing switches and also for putting into fire barrels to keep the water from freezing.

The amount of material reclaimed has increased to a remarkable degree since the plan of sending out the lists to all the shops was put into effect.

PIECE WORK AND CAR INSPECTORS' DUTIES*

BY W. H. SITTERLY

Everyone is working under the most strenuous conditions that have ever confronted us in our railroad life. Our work is harder, due to the fact that more supervision is necessary on account of the calibre of men we are now handling. I mean inexperienced men, as a great many of our co-workers have been called to other fields of labor or to the front. Therefore, the man of the hour is the man who can stand on his tip-toes and meet the conditions that now confront us.

THE PIECE WORK INSPECTOR

The duties of a piece-work inspector are many and of considerable importance to the company he represents and to the foreman under whom he serves. To my mind, the piece-work inspector is a high-class foreman. He must know what work is included in the operation in accordance with the piece-work chart that he works under, and the price paid for the operation. After the repairs are completed, he must inspect in detail each operation to ascertain if the work has been properly and mechanically performed. It is also necessary for him to be thoroughly conversant with the M.C.B. rules, in order that he may determine whether the items of repairs that his men have performed are chargeable to the foreign line or if they are of such a character that the owner is not responsible for the conditions. In this case, he must honestly handle the matter so that the amount of labor and material covering the item will be absorbed by the company he represents. He must be a man thoroughly conversant with car construction, which will enable him to decide quickly and properly whenever matters are put up to him. He should be a student of human nature and know each one of his men—that is, their peculiarities and shortcomings. He must so distribute the work among the men, that he cannot be suspected of showing partiality. If the above qualifications are lacking, the interests of both the company and the men are likely to suffer.

Errors will be made, but proper supervision should correct these errors should they obtain. Piece-work inspectors should see at all times that the men are supplied with the proper tools and that they are in good repair; also, that the proper amount of material is on hand to make repairs. These two items carefully followed, insure satisfied men and quick repairs.

In preparing piece-work cards, the successful and alert piece-work inspector will so word the items of repairs that the M. C. B. billing clerks can intelligently prepare a repair card from the information furnished by him. Each piece-work card involving a foreign car should show specifically the items billable against the owner, likewise the no-bill. Correct original records reflects a great deal of credit on the maker of such records when an investigation is made.

Another duty of the piece-work inspector which means much to the management, is that of carefully supervising the repairmen, to see if they are resorting to sharp practices.

Last, but not least, a strict observance of the M. C. B. Rules of Interchange pertaining to the repairs of cars and the ability not to be moved from this strict interpretation by strong arguments presented must be had. A slight de-

viation from the rules in time leads to greater deviations.

The foregoing are not impossibilities, but conditions under which every piece-work inspector should work.

CAR INSPECTORS

Car inspectors in C. T. yards generally are men that graduate from the repair track, and their duties should consist of inspecting cars in the receiving yard and the classification or departure yards.

In the receiving yard, they should inspect for defects which would prevent the cars from going to destination without repairs, and the cars will either be marked to be set on repair tracks or so marked that repairman who follows the inspectors, will make the repairs. Good judgment is required from the inspector, for every car he keeps off the shop track, money is saved for the company he represents, and the more repairs that are made in the C. T. yards the easier will be the burden of the yardmaster, who we think at times is hard on us as car men. Sometimes I feel that way myself, and other times I see the multitude of things he has to do and a great many times with cramped and inadequate facilities. I then become charitable with him.

The car inspector working on the classification or departure track must inspect for safety the running gear of the car. Likewise, the safety appliances. See that they are in proper repair and in their places. He must also inspect loads in open top cars to ascertain if they are properly chocked and blocked, also that load will pass the clearance dimensions over the route it is to travel. He must make inspection of the journal boxes and contained parts on the car to ascertain if they are in proper condition, and if not, to mark car for identification by the oiler.

While engaged in these daily duties, the car inspector on the C. T. track must, if he desires promotion to the interchange track, thoroughly familiarize himself with the M. C. B. rules, which include the M. C. B. loading rules, tank car specifications, and bureau of explosives regulations. He must also be thoroughly familiar with the cars owned and operated by the railroad with which he is employed, so that when he goes to the interchange track, he is in position to detect wrong repairs on the equipment. In other words, the car inspector successful in receiving promotion is one that does things and does not wait to be asked to do them.

The car inspector at the interchange track carries in his pocket the check book of the company he represents. By this I mean the defect card. In this district, under the Niagara Frontier Car Inspection Association, he is carrying the other fellow's check book, and with it he guards the interests of the company he represents. If we were working in this district under straight M. C. B. rules, he would be called upon by his neighbor for a defect card. However, in this district under the rules we are working, he is carrying the check book or defect card of his neighbor. He must know absolutely the intent and meaning of the M. C. B. rules of interchange insofar as the interchange of cars is concerned—that is, what constitutes a delivering company's responsibility and what is the owner's. His interpretation must be such that he can stand behind it at all times if he refuses a request made upon him unjustly for a defect card.

He must know thoroughly the construction of his company's cars so that he can protect them on the return home in the case of wrong repairs. He must be thoroughly conversant with the loading rules, and, if necessary, to demand an adjustment order, if adjustment is necessary, on the load when ordered. Also, if called upon to visit an industry on the rails of the company he is employed by, give a decision for loading material. He must know when and why to demand a transfer order against a car that is being delivered which must necessarily be transferred.

Added to all of this is the keen judgment brought about by experience to know when a car must or must not be shopped.

* Abstract of a paper presented at the Niagara Frontier Car Men's Association.

TRAIN BRAKE LEAKAGE DETERMINATIONS*

Tests Made With an Orifice Supplying Maximum Allowable Leakage and Brake Pipe Pressure Observed

BY C. R. WEAVER

Supervisor Air Brakes, New York Central, Cleveland, Ohio

THE customary practice in determining the brake pipe leakage in a train made up ready for departure is by making a 10-lb. brake pipe reduction, lapping the brake valve and noting the rate of drop in the brake pipe pressure. From this, together with the volume of air in the train, the cubic feet of free air lost for a definite period of time is determined. This is accepted as a measure of the relative condition of the trains on the road with respect to leakage from the brake system.

After an extended investigation of long freight trains, the writer was convinced that the information so obtained was of little value and rather misleading than otherwise. Trains were found on which the brake pipe leakage, as noted above, was not excessive, and the compressor capacity ample to supply the air required for maintaining the pressure in the brake system, but subsequent observations on the road showed the compressor capacity insufficient to supply the air lost.

There are several causes for apparent disagreement of such observations, namely:

(1) Opening up of leaks in hose couplings and pipe connections when the train is in motion that do not exist when the train is standing.

(2) Leakage caused by movement of apparatus when running due to insecure fastening of reservoirs or brake cylinders to the car body.

(3) Leakage from the auxiliary reservoir side of the triple valve piston caused by leaky gaskets, leaky release valves, etc.

How much influence these causes may have is uncertain, but the fact remains that trains having no more brake pipe leakage, measured in the usual way, than could be easily supplied by the compressor capacity, have been found in numerous cases to overtax the compressor, causing its failure.

It is very difficult to ascertain brake pipe leakage, in fact, it can only be done by closing all the triple valve cut-out cocks throughout the train, which is impracticable and of little value, since it is the volume of air that escapes from the system that is now the vital consideration as far as train movements are concerned, i. e., time to charge the brake system and to restore and maintain the required pressure.

There is, however, another side of this: viz., the effect of the brake pipe leakage on the operation of the brakes, such as lessening the ability to release all the brakes in the train, and lengthening the time in which they can be released. The leakage may also become so great that a brake application commenced by the engineer may result in a continuous application of the brakes. However, this is hardly likely to become serious with the long, large volume air brake trains of to-day, since the capacity of the compressor, the limitations of transmission of the air by the passageways of the brake valve and feed valve, and the ability to transmit air in sufficient quantity through the pipes of the present long trains will be exceeded before the brake pipe leakage, in pounds per minute, has any serious effect upon the operation of the brakes.

For instance, 5 lb. leakage from the brake system,—

equivalent to about 20 lb. per minute with triple valve cut-out cocks closed,—obtained by merely lapping the brake valve, will not materially interfere with the application and release of the brakes, but 5 lb. of air leakage per minute from a 100-car train of 10-in. equipment will amount to 65 cu. ft. of free air per minute. This amount of air leaking from the system of a 100-car train in one minute would not interfere with the operation of the brake as far as application is concerned, but it might seriously interfere with the release of the brakes, since it reduces the ability by 65 cu. ft. of air per minute to raise the pressure in the brake pipe at the rate required to insure release. The compressor may have but little, if any, margin above that required merely to replenish the leakage. In other words, it is clear that if the leakage is kept down to a point where the compressor, the brake valve passages and the brake pipe resistances, and not the leakage, are the chief governing factors of the rise of the pressure in the system, as they should be, there is no need to fear the effect of brake pipe leakage on the operation of the valves in the brake system.

To accomplish this end, it must be understood that the leakage on individual cars must be less under present day train operation than before the present large volume of air was aggregated in one train.

The whole question of brake pipe leakage resolves itself into what quantity of air may be permitted to escape from the brake system and still permit charging, maintaining and replenishing the brake system in such time as will not impose limitations upon traffic in the way of delays, getting the trains ready in the yard, and operating them over the road.

It is very difficult to ascertain what quantity of air is actually leaking out of the brake system. It is not difficult to find out what drop takes place in the pressure, but this varies owing to variations in methods of making tests, positions assumed by triple valves, etc. It is not difficult, however, to fix on some quantity of air that may be permitted to leak out of the brake pipe and then supply in the yard this quantity of air to a train previously charged and observe whether or not the quantity supplied does, or does not, maintain the required pressure. If it maintains or more than maintains the pressure, it is apparent that the leakage of the train is no more than can be permitted. If it does not maintain the pressure then the leakage must be reduced to the point where it can be maintained. The permissible amount of leakage from the entire brake system is the starting point. Too much leakage must not be allowed or an undesirably large compressor capacity or high degree of compressor maintenance will be necessary. An excessively low amount of leakage must not be insisted upon, or traffic will be interfered with on account of the time required to stop the leaks.

In order to arrive at some basis of what would be the allowable leakage, the Interstate Commerce Commission condemning tests of air compressors is the basis of the available compressor capacity. This, by the way, in the writer's opinion allows too wide a variation in the condemning tests. A New York No. 5 compressor is only required to deliver 59 cu. ft. of air, which is only 65.5 per cent of its capacity when in good condition, whereas the 8 $\frac{1}{2}$ -in. cross-compound com-

*Abstract of a paper presented at the September meeting of the Central Railway Club.

pressor is required to deliver 86 cu. ft. of free air, which is 90.5 per cent of its good condition performance.

DETAILS OF TESTS

A method of measuring total train leakage by means of a charging orifice has been suggested and the tests referred to herein were made to determine the proper orifice to be used, the form of the apparatus and its manipulation.

A 100-car freight train was used, conforming to the following specifications:

Size of equipment, 10-in. (combined); length of cars, 42 ft.; brake pipe volume per car, 920 cu. in.; auxiliary reservoir volume, 2,440 cu. in.; leakage uniformly distributed at car 4 and every tenth car up to and including car 94, regulated by cocks in the branch pipe near the triple valve; test gages on branch pipes of cars 1 and 95 and on auxiliary reservoir of car 1.

A special test apparatus was used as equivalent to a yard charging plant. In addition to the charging orifice this contained an air meter (a Toolometer) which gave a direct reading of the amount of air supplied to the train through the orifice for any test condition. It contained a reservoir, the purpose of which was to stabilize the pressure at the orifice.

Some tests required the use of a locomotive the equipment of which was as follows:

Brake equipment, No. 6 ET; main reservoir volume, 50,000 cu. in.; main reservoir pressure, duplex control 100 lb. and 130 lb.; compressor, two 9½-in. or one 8½-in. CC.; steam pressure, 195 lb. to 210 lb.; test gages on main reservoir and brake pipe.

Two main classes of tests were made which may be referred to as charging tests and pump up tests. The special apparatus was used for the charging tests and the locomotive with compressors was used for the pump up tests. Determinations of leakage were also made by the ordinary brake pipe leakage method to compare with the results obtained in the charging tests.

The first charging test was made using an orifice roughly computed to furnish an amount of air equivalent to 75 per cent of the capacity of a New York No. 5A compressor as determined by the condemning test of the Interstate Commerce Commission, which requires this compressor to deliver approximately 59 cu. ft. at 100 single strokes per minute. The orifice was computed to be such a size that with a yard supply pressure of 80 lb. and 70 lb. in the brake pipe of the first car of the train it would supply air to the train at the rate of 75 per cent of 59, or about 45 cu. ft. of free air per minute. This basis is not correct, because it does not take into account the steam pressure and compressor speed which would be obtained when a locomotive compressor is charging the train. However, the basis was agreed to as a starting point for the tests and the pump up test results served later as a new basis for deciding what the size of the charging orifice should be to furnish the maximum amount of train leakage to be permitted.

The orifice computed to the nearest common size drill was 17/64 in. in diameter through metal 1/16 in. thick. Using this orifice in the apparatus and with the supply reservoir maintained constant at 80 lb. pressure the uniformly distributed brake pipe leakage of the train was increased until the air flowing through the orifice was just able to maintain 70 lb. pressure in the brake pipe of the first car. When this balance of pressure was obtained the Toolometer by-pass was closed and a reading taken of the amount of air or rate required to supply the leakage so obtained. This rate was found to be 41 cu. ft. of free air per minute and the pressure noted on the 95th car was 61¼ lb., or a drop in pressure of 83¼ lb. between the front and rear of the train.

This rate of leakage was assumed as the basis for making pump up tests, using the locomotive with two 9½-in. compressors and 200 lb. steam pressure instead of the yard plant

apparatus. The first pump up test was made starting with the train empty, brake valve handle in service position, main reservoir pressure at 130 lb. and by moving the brake valve handle to running position. The movement of the brake valve handle began the charging of the train through the feed valve and at the same time operated to reduce the main reservoir control to 100 lb. pressure. At various time intervals the main reservoir pressure and the brake pipe pressures on the locomotive, car 1 and car 95, were simultaneously observed. The time required by the two 9½-in. compressors to charge the train through the feed valve to 70 lb. pressure on the head end was measured in this manner. This test was then repeated, except that the brake valve was first placed in full release position and held there until the auxiliary reservoir on car 1 reached 65 lb., when it was moved to running position. This test was made to show how much time could be saved in charging the train by avoiding the use of the feed valve until it was necessary to avoid over-charging. The effect of larger compressor capacity on the time required to charge the train under these conditions was shown by repeating the above test after substituting an 8½-in. CC. compressor for the two 9½-in. compressors.

When the train was charged up to 70 lb. pressure on car 1, and while using the two 9½-in. compressors, an attempt was made to increase that pressure from 70 lb. to 85 lb. by placing the brake valve handle in full release position. After more than 20 minutes the pressure became stationary at 82½ lb. Later the yard plant apparatus was connected to the train and the pressure against the orifice raised until the brake pipe pressure on the first car was maintained at 85 lb. The Toolometer reading showed that it was necessary to supply air at the rate of 50.4 cu. ft. of free air per minute to maintain the total train leakage under these conditions.

It was then concluded that the total leakage rate of 41 cu. ft. of free air per minute at 70 lb. pressure on car 1 was too great, and that the yard plant orifice area and the corresponding total leakage rate should be reduced. This conclusion was based on the assumption that two 9½-in. compressors in good condition would be equivalent to one New York No. 5A compressor when in the condition determined by just passing the I. C. C. condemning test. It was recognized that this assumption was not strictly correct, but as it was not possible to use a No. 5A compressor it was agreed that these two compressor combinations were nearly enough equivalent to base the pump up test results on the two 9½-in. compressors. In this same connection it was also pointed out that the final determination of the maximum permissible total train leakage would depend largely on how the proposed method of testing this leakage should affect the time required both to make up the trains and also to handle them over the road in actual service.

Following the tests described the yard plant apparatus was reconnected to the train and the charging orifice size reduced from 17/64 in. to 1/4 in. in diameter. While maintaining an air pressure supply of 80 lb. for this orifice the uniformly distributed train leakage was adjusted as before described until this orifice was able to maintain a brake pipe pressure of 70 lb. on the first car of the train. The Toolometer reading under this condition showed a total leakage rate of 35 cu. ft. of free air per minute.

The locomotive using the two 9½-in. compressors was again connected to the train and a pump up test, starting with the brake valve handle moved to running position was made similar to the one previously described, except for the reduced amount of total leakage. When the train was charged to 70 lb. pressure on car 1 the feed valve setting was raised and the time noted to raise the brake pipe pressure from 70 lb. to 85 lb. pressure on car 1. This time was about 15 minutes. It was then concluded that the rate of total train leakage of 35 cu. ft. of free air per minute as determined by using a 1/4-in. orifice with the yard plant supply pressure of 80 lb. to charge

the train to 70 lb. on the head end would be a correct basis for fixing the size of the testing orifice.

The above pump up test was then repeated under the same conditions, except the brake valve was first moved to full release position until the auxiliary reservoir on car 1 was charged to 65 lb. pressure when the brake valve handle was returned to running position. This test was made to show how much time could be saved in charging the train by avoid-

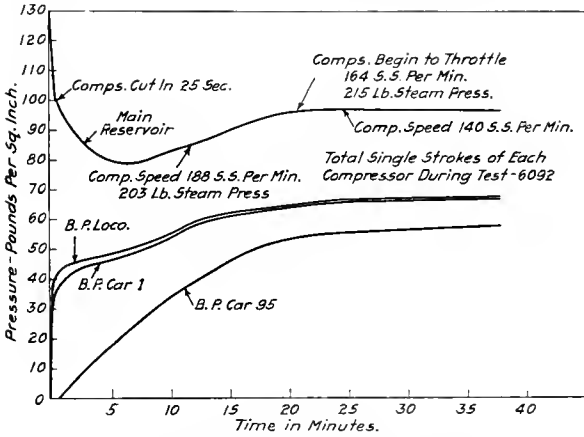

Fig. 1—Time of Charging Train with Leakage of 41 Cu. Ft. per Minute; Brake Valve in Running Position

ing the brake valve running position without over-charging the head end of the train too much.

Following these tests the yard plant apparatus was reconnected to the train and three tests made to show the time required to charge the train from atmosphere to 70 lb. pressure on the head end from the yard plant at 80 lb. pressure through the orifice by three different methods. The total train leak-

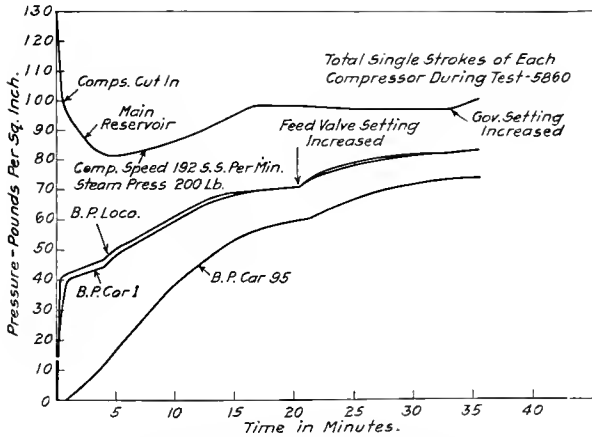
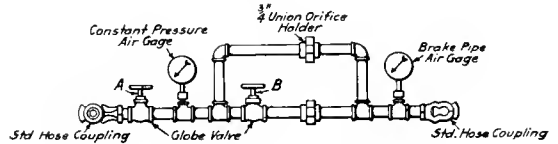

Fig. 2—Time of Charging Train with Leakage of 35 Cu. Ft. per Minute; Brake Valve in Running Position

age was 35 cu. ft. of free air per minute with 70 lb. pressure on car 1 and the leaks uniformly distributed.

The first of these tests was made with yard plant supply pressure held at 80 lb. and a by-pass around the charging orifice wide open. During the test this by-pass was gradually closed so as to hold the brake pipe pressure on car 1 constantly at 70 lb. until just as the train became fully charged the by-pass was completely closed. This method gave the shortest possible time in which the train could be charged by the yard plant without overcharging the head end and it

will serve as an example of the proper manner for operating such apparatus when measuring total train leakage. If for example, when testing a train the pressure on the head end cannot be maintained at 70 lb. with the by-pass completely closed, it will indicate that the total leakage is more than 35 cu. ft. of free air per minute, and should be reduced, whereas if with the by-pass closed the pressure on the head end can be maintained or built up higher than 70 lb. it will indicate that the total leakage is equal to or less than the maximum permissible amount and the train can be allowed to proceed. The second test was made by charging up in the same manner as in the first test except that when the pressure on car 1 reaches 70 lb. the by-pass around the charging orifice was



closed instantly instead of gradually. The third test was made by charging up through the orifice with the by-pass around it closed at all times. During all of the three of these tests the brake pipe pressures on cars 1 and 95, the auxiliary reservoir pressure on car 1 and the Toolometer readings were observed at various time intervals.

Following the first charging test described, two ordinary brake pipe leakage tests were made, one with the brake equipments cut in and the other with all but 12 brake equipments cut out. It was not possible to cut out these 12 equipments on account of leakage cocks and gages in use. A Toolometer reading of the air required to maintain the leakage with the equipments cut out was also taken. These tests served to compare the Toolometer reading with the ordinary brake pipe leakage test method of measuring leakage with the effect of auxiliary reservoir leaks substantially eliminated. The resultant calculations showed the leakage according to the or-

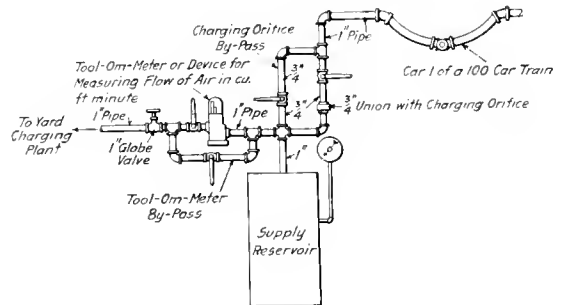

Fig. 4—Apparatus with Which the Orifice Leakage Tests were Made

inary leakage test to be 32.7 cu. ft. of free air per minute and according to the Toolometer reading 33.4 cu. ft. of free air per minute. The difference is remarkably small and could be accounted for by the possible existence of small leaks in the auxiliary reservoirs of the 12 equipments not cut out.

The ordinary leakage tests were made by overcharging the train so that the head end was at approximately 85 lbs. A 20-lb. reduction at the brake valve was then made and the train allowed to leak down. Beginning at 60 lb., simultaneous readings of brake pipe readings of brake pipe leakage on the locomotive, car 1 and car 95 were obtained at 10-second intervals. This test was made first with all triple valves cut in and then repeated with all triple valves cut out except those on the twelve cars fitted with gages and leakage cocks. In the first case the pressure drop during the

first minute was 7 lb. on the locomotive, 7.5 lb. on car 1 and 7 lb. on car 95; in the second case the pressure drop was 7.5 lb. on the locomotive, 8 lb. on car 1 and 7.5 lb on car 95. Under the conditions of the second of these two tests the Toolometer showed that 33.4 cu. ft. of free air per minute were required to supply leakage, where 41 cu. ft. were required when all the equipments were cut in. The calculated volume of free air of 32.7 cu. ft. per minute was determined on the basis of the pressure drop recorded in this test.

Fig. 1 shows a graphic record of the results of the pump up test in which an empty train was charged to a pressure of 70 lb. on car 1 against a leakage adjusted to 41 cu. ft. of free air per minute on the fully charged train. The compressor equipment consisted of two 9 $\frac{1}{2}$ -in. air pumps operating on 200 lb. steam pressure, with a duplex main reservoir control of 100 lb. and 130 lb. The train was charged with the brake valve in running position.

Fig. 2 was obtained under the same conditions except that the leakage had been reduced to 35 cu. ft. of free air per minute on the fully charged train. In this test the pressure on car 1 was raised to 85 lb. by raising the feed valve setting.

CONCLUSIONS

The ordinary method of measuring brake pipe leakage on trains is not an accurate check on the total amount of train leakage which the compressor on the locomotive must be able to supply if the train is to be handled successfully.

The method suggested for measuring the total leakage by charging the train through an orifice supplied with a fixed pressure does not afford an accurate means of measuring the total train leakage.

If the maximum permissible amount of train leakage is fixed upon, an orifice size can be determined which when supplied with a constant pressure of 80 lb. from a yard plant will just supply the necessary amount of air to the train to maintain the leakage specified.

Such a charging orifice can conveniently be used while charging a train from the yard plant and it will afford a means for accurately determining whether the total leakage of the train is less than, equal to or greater than the maximum permissible leakage.

The best method of manipulating the charging orifice test apparatus, a proposed form of which is shown in Fig. 3, is for the operator to start the test with the by-pass around the orifice open and then as the train charges gradually close this by-pass so as to maintain 70 lb. brake pipe pressure on the first car of the train. This method will accomplish the charging of the train in a minimum of time and avoid any objectionable overcharging.

The foregoing seems to point out the necessity of a better brake maintenance and a better initial installation of the brake apparatus; this has particular reference to securing the reservoirs and cylinders to the car body and proper clamping of the brake pipe. A large majority of the leaks are due to loose reservoirs, cylinders, and brake pipes. Tightening of the unions when these parts are loose only affords temporary relief. More attention should be paid to hose couplings when mounting hose, as many are found that do not gage and when coupled, leak.

A recent investigation of 12 trains, varying from 80 to 114 cars per train, showed a loss of air from 50 per cent to 93 per cent of the compressor capacity. Losses of this kind are not only expensive in compressor maintenance and coal consumption, but cause serious delays to traffic.

The writer wishes to express his appreciation to the Westinghouse Air Brake Company for assistance in conducting the tests and compiling the test data.

DISCUSSION

The discussion indicated a general appreciation of the seriousness of train leakage on roads handling trains ap-

proaching and often exceeding 100 cars. Not only has the difficulty of maintaining and supplying adequate train pipe pressure been increased by the handling of long trains, but heavy cars and the severe shocks which result from rough handling have greatly added to the difficulties of maintaining a reasonably tight train line. Under these conditions, reservoirs inadequately secured and pipes not sufficiently clamped, are soon jarred loose and excessive leaks result. The need of co-operation between the maintenance forces and designers, in order that the location of the air brake equipment and the methods of securing it to the car may be such that it will adequately perform its functions, was pointed out.

The opinion was expressed that the time has arrived when a complete system of piping designed especially to meet the requirements of locomotive and car service is needed. The piping now in use is not essentially different from that used for gas and water in our houses under the most favorable conditions so far as external stresses are concerned; it is an adaptation of existing facilities not well suited to meet the entirely different conditions under which they must operate. Attention was called to the frequency with which a poorly designed piping layout is found on hopper bottom cars where the reservoir is often placed directly over the train pipe with a branch pipe not over 12 in. or 14 in. long, and this made up largely of elbows and couplings. With the train pipe located between the center sills it is often impossible to locate, much less attend to repairs to a leak when it is located.

One of the most prolific causes of train leaks is inadequate reservoir fastenings which permit the reservoir to become loose under the stresses imposed in service. It is usually the practice to leave the stopping of leaks until trains have been made up and tested in the yards. Under such conditions time does not permit of doing more than patching up unions and other similar repairs, the result being that leaks caused by loose reservoirs are immediately opened up again as soon as the train is in motion. It was suggested that such repairs might well be made on the house track while cars are being loaded, at which time the leaks could be permanently stopped and delays in despatching trains materially reduced.

HOT BOXES ON FREIGHT CARS

BY "OLD RAILROADER"

Hot boxes are caused by one or the other of the nine following causes:

First.—Poor lining used in filling the brasses. Too much lead is used in the composition and the brass is not properly cleaned before truing it.

Second.—Journal keys not fitting properly in the box or on the brass. There should be a certain allowance made in all keys so that the weight on the journal is properly distributed. If not, that part of journal that has the greatest weight will heat and cause trouble.

Third.—Arch bars not in proper alignment. This defect has more to do with heated journals and hot boxes than is realized. One cause for improper alignment is derailments. All derailed trucks should be carefully examined.

Fourth.—Improper loading. If from any cause excessive loading is placed on any one journal, due either to the side bearing clearance being too small, or shifting of the lading, or improperly loaded car, heated bearings will result.

Fifth.—Flat spots on wheels. This condition also has been known to cause heated journals as the pounding will cause the lining of the brass to be crushed out.

Sixth.—Lack of lubrication. Sometimes the waste or packing is not properly prepared and in the majority of cases the proper time is not allowed for the oil to saturate through the waste.

Seventh.—Defective packing. This condition is brought about by the desire to save all old packing for reuse after it has been improperly sorted.

Eighth.—Rough journals. This condition causes more hot brasses than any of the other causes. This should be carefully watched by every one. Any journal that has been hot and cooled with water by a train crew should not be allowed to leave yard until another pair of wheels be applied

Ninth.—Open boxes. Those that have no dust guards or are allowed to run without lids, or improperly fitting lids, cause heated journals due to the grit, etc., that gets into boxes, particularly during the summer months.

After 39 years of railroad work the writer is of the opinion that if a good clear manual of instructions could be compiled, so that the box packer and car repair man would know how to properly pack a journal box it would prove valuable.

AUTOMATIC STRAIGHT AIR BRAKE

A New System for Passenger and Freight Equipment Which Has Many Interesting Features of Operation

A NEW air brake system has recently been perfected by the Automatic Straight Air Brake Company, 14 Wall street, New York, for freight and passenger equipment, which contains many new and interesting features of operation. The purposes of this brake are to give rapid serial action to the brakes throughout a train, to maintain a constant and uniform brake cylinder pressure regardless of piston travel, to permit a variation of brake cylinder pressure at the will of the engineer, to provide a proper and

that ordinarily used, the service reservoir has a volume of 2,100 cu. in. and the quick action reservoir a volume of 200 cu. in., which with an additional volume due to brake pipe connections, gives an increase in volume of about 2,300 cu. in. per car on 10-in. freight equipment. The service reservoir is used for service and emergency applications of the brake, the auxiliary reservoir is used for an emergency application of the brake and for a quick release of the brake in contrast to a graduated release. The quick action reservoir is used only in making an emergency application of the brakes. The triple valve is made up of disk valves and diaphragms, no slide valves or pistons being used.

Due to its construction and operation this brake has the characteristics of a straight air brake and at the same time is automatically operated. The straight air features are obtained through the fact that with every application of the brakes air is exhausted from the brake pipe under each car. In case of a service application air from the brake pipe is exhausted into the brake cylinder and in case of an emergency application the air from the brake pipe is exhausted to the atmosphere. In the first case, the air is not

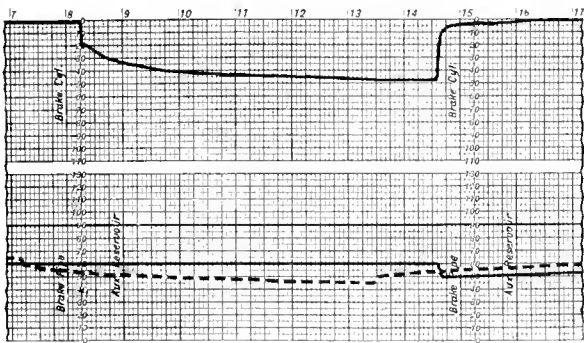

Service Application of the Brakes with Quick Release

The top curve represents brake cylinder pressure, the full line in the lower set of curves represents the pressure in the auxiliary reservoir, while the dash line shows the pressure in the brake pipe. The pen indicating the brake pipe pressure is set a distance of one minute back of the pens indicating the brake cylinder and auxiliary reservoir pressures. The above curves show that as the brake pipe pressure is reduced, the brake cylinder pressure of 20 lb. is obtained at once, which is increased on further reduction of the brake pipe pressure to about 50 lb., the pressure in the auxiliary reservoir remaining constant. With the building up of the brake pipe pressure, a small amount of air from the auxiliary reservoir is released to the brake pipe to hasten the release, the rapidity of release being indicated by the brake cylinder curve.

quick release of the brakes for any brake pipe reduction, to provide for a full emergency application of the brakes at any time, to provide a graduated or quick release as desired, and to provide an economical use of air.

This brake system provides a quick action passenger brake, one brake cylinder being used for a service application and two brake cylinders for an emergency application of the brakes. As the triple valve is capable of compensating for varying volumes in brake cylinders, a second brake cylinder can be added to existing freight equipment for empty and load braking, the braking system retaining at the same time all of its functions and principles.

The brake is operated by the engineer in the same manner as is common with present day practice. The equipment can be used interchangeably with other existing equipment. The main features of this new brake are found in an entirely new triple valve with its auxiliary, service and quick action reservoirs. The auxiliary reservoir is of the same volume as

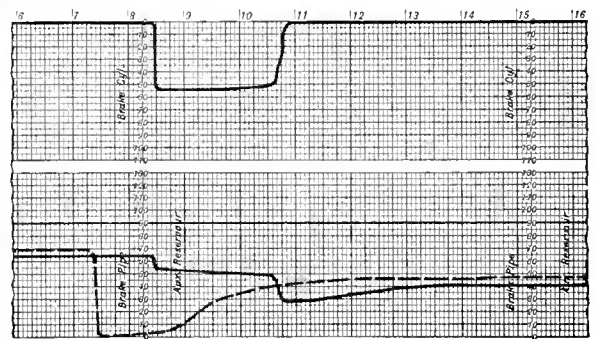

Emergency Application of the Brakes

In this case the brake pipe pressure was reduced to zero, giving an instantaneous brake cylinder pressure of 55 lb. with an accompanying decrease in auxiliary reservoir pressure. At release more air is taken from the auxiliary reservoir to aid the release as described under the quick release operations, the brake being released in about 10 seconds. Due to the construction of the triple valve, the auxiliary reservoir pressure is then raised, through the charging port, with the brake pipe pressure, the difference in the amount being due to the spring used on the auxiliary reservoir diaphragm. This record was obtained from car 91 in the 100-car test rack described in the text.

wasted but is used to build up the pressure in the brake cylinder in conjunction with the supply of air from the service reservoir. In both cases the rapidity of serial action is increased due to the fact that the brake pipe pressure is reduced locally at each car.

The design of the triple valve is such that when fully charged the pressure in the brake pipe acting on the under-

side of a diaphragm balances the pressure in the auxiliary reservoir acting on the upper side. A reduction in brake pipe pressure causes the auxiliary reservoir pressure to force the diaphragm downward admitting air to the brake cylinder from the brake pipe and service reservoir. The air in the brake cylinder acts on a second diaphragm which is connected to the first and which is of one-half its area. The pressure in the auxiliary reservoir remains unbalanced forcing the diaphragm down until the force exerted by the brake pipe pressure on the underside of this diaphragm plus force exerted by the air in the brake cylinder on its diaphragm exceeds it. The diaphragm will then be raised and the supply of air to the brake cylinder cut off. Thus it will be seen that the brake cylinder pressure bears a direct relation to the brake pipe reduction and is not affected by the brake piston travel or brake cylinder leakage. By regulating the brake pipe pressure, any brake cylinder pressure may be obtained.

Each triple valve is provided with means for making a graduated or quick release. The graduated release is obtained by building up the brake pipe pressure from the locomotive. The quick release feature is obtained by raising the brake pipe pressure three pounds, at which time auxiliary reservoir air is released to the brake pipe under each car.

Interesting features of this brake are that service applica-

CHARGING THE TRIPLE VALVE

The air from brake line 1 passes into chamber 2 of the service section and into pipe 1a leading to the emergency section.

Service Section.—The air pressure in chamber 2 acts on the diaphragm 3, raising it until the valve 9 is uncovered. This permits the air to pass through a small port 18 into chamber 4 and the auxiliary reservoir. The spring 7c exerts a force equivalent to three pounds of air and as soon as the pressure in chamber 4 is within three pounds of the pressure in chamber 2 the valve 9 will close.

The air from chamber 2 also passes through port 12 into the hollow stem 6 past the non-return valve 32a into chamber 30 and on top of valve 32.

From chamber 2 the air also passes through the passage 42 to chamber 40a, where it raises the diaphragm 43 which lifts the left hand end of lever 65, opening valves 71 and 55. The air passing through valve 71 passes through pipe 68, past the maintaining valve, when open, to pipe 41c and on top of the valve 77. The air passing through valve 55 passes through pipe 10 to chamber 85 of the change-over valve and from there through valve 95 and hollow stem 94 to the service reservoir. From chamber 85 the air also passes up through ports 14 into chamber 90 above the diaphragm 88.

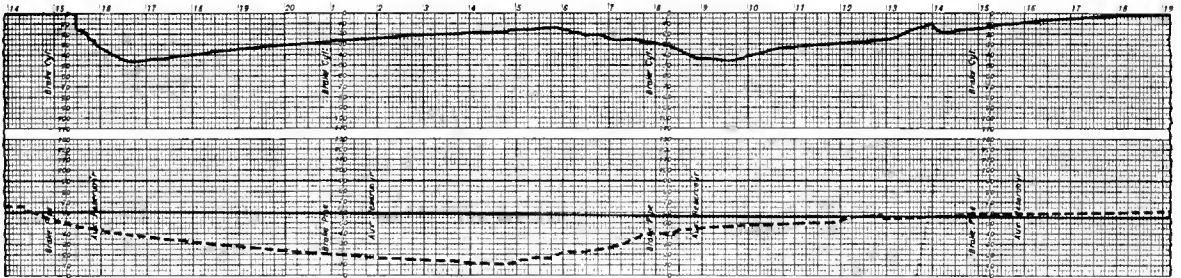

Performance of the Brake Under Conditions of a Gradually Depleted Brake Pipe, Showing the Performance Under Graduated Release

With the reduction in brake pipe pressure, the brake cylinder pressure increases until both are about 45 lb. From that point a further reduction in brake pipe pressure will cause a reduction in brake cylinder pressure, and in no case below this point will the brake cylinder pressure be less than the brake pipe pressure. A prolonged reduction of the brake pipe pressure was made purposely to disclose this fact. As the brake pipe pressure increases, the brake cylinder pressure increases until a pressure of 45 lb. is obtained in both the brake cylinder and brake pipe. From that point on, the graduated release goes into operation and with a further increase in brake pipe pressure, the brake cylinder pressure will be reduced. It will be noted that the auxiliary reservoir pressure has not changed.

tions can be varied at the will of the engineer by his regulation of the brake pipe pressure without the necessity of releasing the brakes before a re-application when operating with the graduated release, and the fact that the auxiliary reservoir maintains a reserve supply for a full emergency application, regardless of the number of service applications made. The triple valve is of such a design that after a train has once been charged, an emergency application will automatically be made if for any reason the brake pipe pressure should be reduced to zero.

This company has been making a series of exhibition tests on a 100-car test rack composed of 51 A S A brake equipments and 49 brake equipments in common use today, which were attended by between 200 and 300 railroad representatives. The equipments have been distributed in multiples of five throughout the train, that is, five A S A equipments, five other equipments, etc., with the hundredth car being an A S A equipment. These tests have shown that the time between the application of the brakes on the first car and the hundredth car with a service application is about 14 seconds, and with an emergency application about 8 seconds. Records taken on trainographs of a service application with quick release, a service application with graduated release and an emergency application are shown in the illustrations.

The following, to be used in connection with a diagrammatic illustration of the triple valve, gives an outline of the operation of the A S A triple valve:

The air passing through valve 55 also passes to chamber 47 above the diaphragm 43. As the pressure in chamber 47 plus the pressure caused by spring 50 equalizes with the pressure in chamber 40a, the diaphragm 43 will be depressed. This allows the valves 71 and 55 to be closed by their respective springs.

Emergency Section.—The air in pipe 1a passes to chamber 39a past the clearance 44 into chamber 40 above the diaphragm 39, keeping the valves 60 and 60a closed. This pressure also acts on valve 46, keeping it closed. From chamber 39a the air also passes through the port 68 to the chamber 81, then down through port 74 to the quick action reservoir.

SERVICE BRAKE APPLICATION

The service application of the brake is made in the usual way by reducing the brake pipe pressure. This reduces the pressure in chamber 2 of the service section and pipe 1a leading to the emergency section.

Service Section.—The reduction in pressure in chamber 2 permits the pressure in the auxiliary reservoir and chamber 4 to depress the diaphragm 3. This lowers the valve stem 6 and with it diaphragm 29, valve cage 28 and valve 32 and with it valve 35, which is rigidly connected to 32. As valve 35 seats on the cage 135, the opening between the brake cylinder and chamber 25 with the atmosphere is closed. The cage 28 drops away from the valve 32, permitting the air

in chamber 30 to pass into chamber 25, which is connected directly to the brake cylinder, thus charging the cylinder. Air also flows from chamber 40a and from the service reservoir through the valve 95, pipe 10 and valve 55 to chamber 2, thus augmenting the air supply in chamber 2 which passes to the brake cylinder.

As the force exerted by the air pressure in chamber 25 on the diaphragm 29 plus the force exerted by the air pressure in chamber 2 on diaphragm 3 exceeds the force exerted by the air pressure in chamber 4 plus the pressure of spring 7c, the spindle 6 will be raised with the valve cage 28, seating valve 32, cutting off the supply of air to the brake cylinder. Since the area of diaphragm 29 is about one-half that of

47 will be reduced with the pressure above the valve 55, but as it with the spring 50 is greater than the pressure in chamber 40a, the diaphragm 43 will always remain down during the service application of the brake.

Emergency Section.—The reduction of the brake pipe pressure causes a reduction in chambers 39a and 40 without operating any of the parts. The reduction is so gradual that the pressure from 81 will be relieved through passage 69 without operating diaphragm 63.

RELEASING THE BRAKES

Graduated Release.—To obtain the graduated release the maintaining valve 80 is closed, thus cutting out the use of the

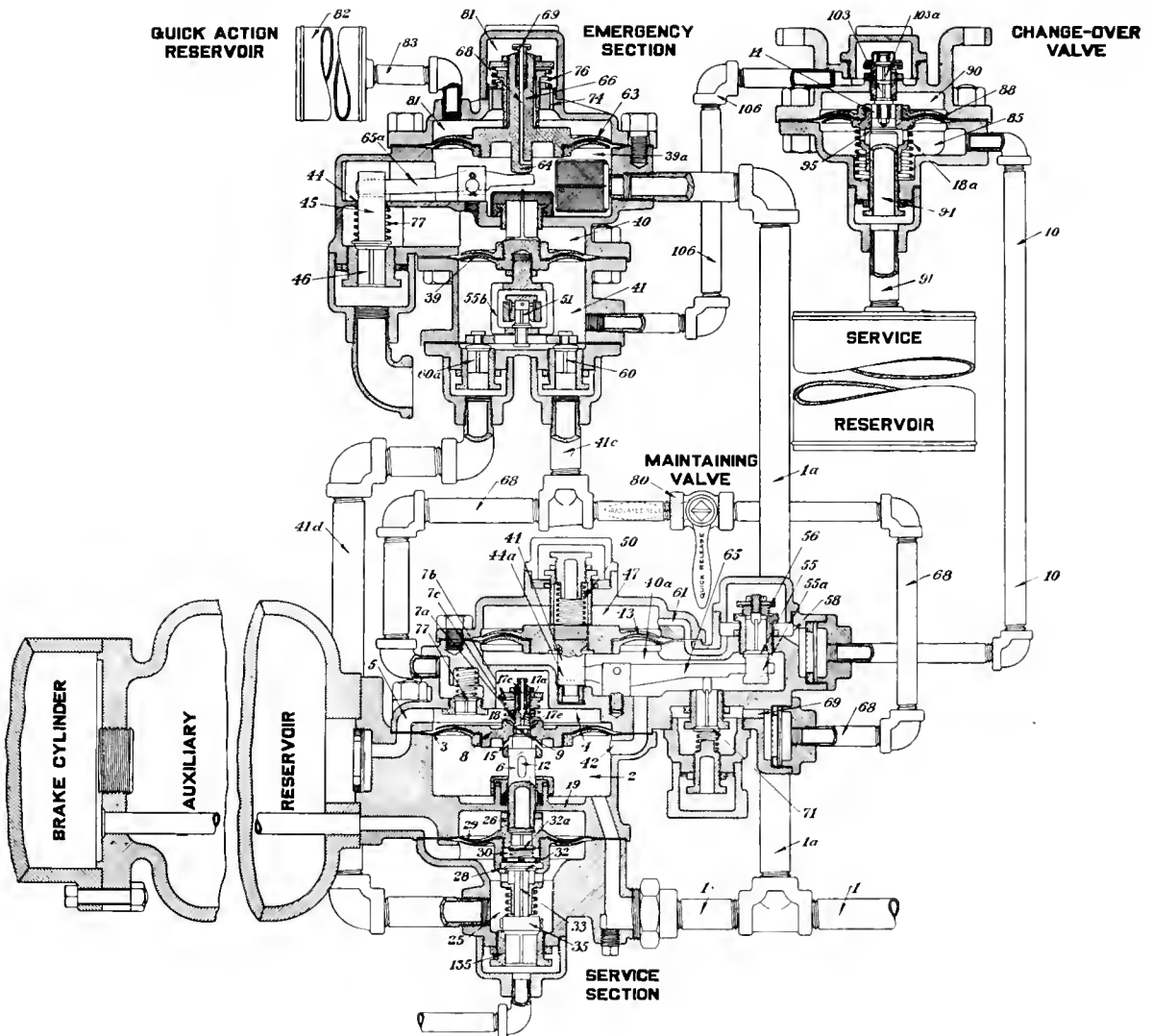

Triple Valve for the Automatic Straight Air Brake System

diaphragm 3, the pressure in chamber 25 to provide equilibrium will be about twice the reduction made in chamber 2. If for any reason the pressure should leak off from the brake cylinder, the forces will again become unbalanced and valve 32 will again be opened until equilibrium is once more established. In this way the brake cylinder pressure will always remain a certain definite function of the brake pipe for each brake pipe reduction. The air pressure in chamber

valve 77 and the auxiliary reservoir pressure. With the service section in lap position, that is, with the pressures in chambers 25 and 2 balancing the auxiliary pressure in chamber 4, by raising the brake pipe pressure and the pressure in chamber 2, diaphragm 3 and with it valve stem 6, diaphragm 29 and valve cage 28 will be raised, this will lift valve 35 from its seat, permitting the air from the brake cylinder to release to the atmosphere until the

pressure in chamber 25 has been reduced sufficiently to re-establish the balance destroyed by the increase in brake pipe pressure. At this time the service section will again move to lap position. In this way the release may be graduated in as many steps as desired, the full release being obtained when the brake pipe pressure has been restored sufficiently to balance the auxiliary reservoir pressure. In case it is desired to reapply the brakes after a partial release has been made, this can be done by simply reducing the brake pipe pressure again.

Quick Release.—To obtain the quick release, the main-
 taining valve 80 is opened, as shown by the full lines in the illustration. With the increase in pressure in chamber 2, the performance of the service section will be as described above. The pressure in chamber 40a will be built up, raising diaphragm 43 and with it the left hand end of lever 65, which will open valve 71 a short time ahead of valve 55 on account of the clearance between the right hand end of the lever and the bottom of the slot in the valve body 55a. Opening valve 71 permits air from the auxiliary reservoir which is at a higher pressure than the air in chamber 40a to pass forward through valve 77, pipe 68, through valve 71 into chamber 40a, thus rapidly increasing the pressure in chamber 2 and insuring a quick release of the air pressure from the brake cylinder. With the brakes released the system will be recharged as described above.

EMERGENCY APPLICATION

There are no movements of the parts in the emergency section during charging, service, lap, and release operations. The moderate service brake pipe reductions permit the air to flow from the quick action reservoir 82 to the train pipe through the restriction screw 69 at the same rate as the brake pipe reduction is taking place, thereby maintaining equal pressures on both sides of diaphragm 63.

To obtain an emergency application, a rapid and prolonged brake pipe reduction is made. This causes the service section to assume service position quickly and reduces the pressure in chamber 39a of the emergency section faster than the pressure in the quick action reservoir 82 can be reduced through the restriction screw 69.

The pressure in chamber 81 above diaphragm 63 will then be higher than the pressure in chamber 39a, with the result that diaphragm 63 will be forced down. Stem 64, moving with the diaphragm, will depress the inner end of the fulcrum lever 65a and the left end will be raised, thereby raising the brake pipe exhaust valve 46, and venting the brake pipe pressure direct to the atmosphere.

The sudden reduction of brake pipe pressure quickly reduces the pressure in chamber 40a of the service section, thereby opening the valve 55 and causing a corresponding reduction in chamber 85 of the change-over valve through pipe 10. The pressure in chamber 85 of the change-over valve will then be reduced faster than the service reservoir pressure can flow through the restricted opening of valve 95, and as the upper chamber 90 is in direct communication with the service reservoir through ports 14, the high service reservoir pressure above diaphragm 88 forces the diaphragm down. This movement closes valve 95 and opens valve 103. The closing of valve 95 seals the service reservoir from the brake pipe, and the opening of valve 103 releases the service reservoir air to chamber 41 of the emergency section through valve 103a and pipe 106.

This action occurs instantly and diaphragm 39 is raised by the decreasing brake pipe pressure in chamber 40, and the increasing service reservoir pressure in chamber 41, thereby raising the yoke 55b. The upward movement of the yoke closes vent valve 51 and opens valves 60 and 60a. The opening of valve 60 releases the auxiliary reservoir to chamber 41 through pipe 41c. From chamber 41 the air from both the service and auxiliary reservoirs flows past

valve 60a through pipe 41d to chamber 25 and the brake cylinder.

The operation of the parts just described quickly reduces the brake pipe pressure, and assures a quick and positive emergency application of the brakes throughout the train.

Valve 46 will remain open until the entire brake pipe pressure has been reduced sufficiently to assure an emergency application. The length of time depends upon the time required to vent the pressure in chambers 81 and 82, above diaphragm 63, to chamber 39a. This is determined by the size of the opening through the restriction screw 69. When the pressure in chamber 81 has been reduced to an equality with that in chamber 39a, spring 76 raises diaphragm 63 and spring 77 closes valve 46.

A release of the brakes after an emergency application is effected by raising the brake pipe pressure above the pressure in chamber 4, which, in emergency, is equal to brake cylinder pressure. When the pressure in the brake pipe and in chambers 2 of the service section and 40 of the emergency section is raised above the equalized pressure in chambers 4 and 41, diaphragm 39 will be depressed, closing valves 60 and 60a and opening vent valve 51. This releases the pressure in chamber 41 to the atmosphere, and the upward movement of diaphragm 3 opens exhaust valve 35, releasing the brake cylinder pressure to the atmosphere.

When the brake pipe pressure has been raised in chamber 85 of the change-over valve above the service reservoir pressure in chamber 90, diaphragm 88 will be raised to its normal position in which it is held by spring 18, and the service reservoir will again be charged.

Should an emergency application be desired following a service application, and service reservoir and brake pipe pressures are below the emergency brake cylinder pressure, valve 103a will prevent the emergency brake cylinder pressure from returning to the service reservoir.

CALCULATING HEIGHT OF GRAIN LINE FOR BOX CARS

BY THOMAS R. WILLIAMS

Mechanical Draftsman, Northern Pacific, St. Paul, Minn.

The purpose of this article is to show the method of calculating the height of grain lines in box cars and to reduce as much as possible the calculations to constants which can be taken from a table.

The height to which a car can be loaded with grain depends on the length and width of car, the lading capacity of car in pounds, and the weight per bushel of various kinds of grain.

- Let H = Height of grain line in inches
- L = Length of car in inches
- W = Width of car in inches
- C = Lading capacity in pounds
- Y = Weight per bushel of grain

The weights per bushel for various kinds of grain are as follows:

Wheat	60 lb.
Corn, eye or flax	56 lb.
Barley	48 lb.
Oats	32 lb.

The number of cubic inches in a bushel is 2150.42. Then the bushels in car for each inch of height is:

$$L \times W \div 2150.42$$

$$\text{and } H = \frac{C}{L \times W \div Y} = \frac{2150.42 \times C}{L \times W \times Y}$$

In this formula all of the factors except the length and width of the car can be reduced to constants for the various

grains and car capacity. These constants are shown in the following table:

	CONSTANTS						
	Weight per bu.	40,000 capacity	50,000 capacity	60,000 capacity	70,000 capacity	80,000 capacity	100,000 capacity
Grain (lb.)							
Wheat	60	1,433,613	1,792,017	2,150,420	2,508,823	2,867,227	3,584,033
Corn, rye							
Max.	56	1,536,014	1,920,018	2,304,021	2,688,025	3,072,028	3,840,035
Barley	48	1,792,017	2,240,020	2,688,025	3,136,029	3,584,033	4,480,042
Oats	32	2,688,025	3,360,030	4,032,038	4,704,044	5,376,050	6,720,063

The simplified formula then becomes:

$$H = \frac{\text{constant}}{L \cdot W}$$

By keeping this table for reference it will be an easy matter to determine the grain line heights.

HOSPITAL CAR FOR THE ERIE

To meet the demands of the Government for appropriate cars in which to transport sick or wounded soldiers, the Erie has remodeled a 70-ft. steel underframe parlor car, as shown in the illustrations, providing it with 28 adjustable cots placed in two tiers. The car is provided with a receiving and supply room 10-ft. 8 1/2 inches long, with a

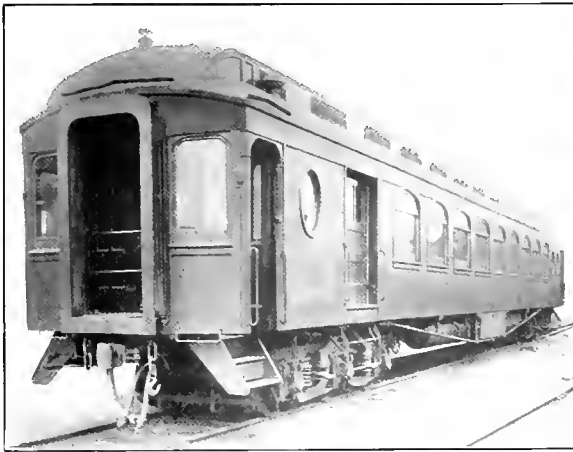

Erie Hospital Car

sliding door at each side, at one end of the car. At the other end is a small rest room for the nurses, provided with a sofa and lavatory. The main portion of the car is about 50-ft. 6 inches long and contains seven two-story cots on each side.

The two-story cots are of a new design furnished by Frank

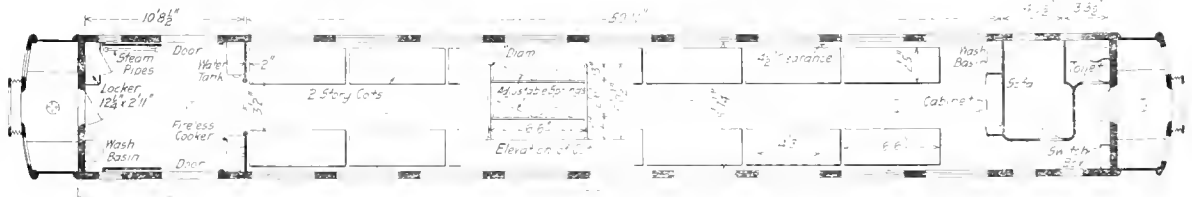

Floor Plan of Erie Hospital Car

A. Hall & Sons of New York. The springs of these cots are adjustable to any desired position for a patient's back or legs. This is clearly shown by a sketch on the floor plan of the car. The cots are finished in white enamel.

The supply room contains a fireless cooker, drinking water tank, wash basin and supply locker. The annunciator on

which calls from any part of the car are indicated is also located here. It is separated from the main compartment by heavy rubber curtains.

The car is equipped with electric lights the lighting fixtures being located on the side decks. Emergency



Interior View of the Erie Hospital Car

lights are provided by Pintsch gas lamps located in the center of the upper deck.

The interior finish of the new hospital car is a light gray which is easy to the eyes.

NEW FLOOR PLANS FOR POSTAL CARS

A modification of plans for the construction of postal cars has been approved and issued as an optional standard by the Division of Railway Mail Service of the Post Office Department. The changes have been made with a view to providing designs that can be easily converted from one standard length to another when service conditions make it necessary to increase or decrease the space devoted to handling mail. The cost of maintaining postal cars conforming to the requirements of the Post Office Department should be materially lessened by this arrangement.

The new plans consist of minor modifications of existing standards which will make it possible to convert a 60-ft. postal car into a 30-ft. apartment car, or change a 30-ft.

apartment car into one having a 15-ft. apartment. In case it is desired to return to the original arrangement it can be done at slight expense. These changes have been made possible by making the location of the doors and windows common to either size car.

The Post Office Department points out in connection with

these plans that the work of transforming from one length to another may be greatly facilitated by making the interior equipment more nearly portable than is customary at present. Screws and bolts may be used for securing fixtures which are

compartment by framing the side doorways at one end for the company's standard baggage door-opening and filling in with false work to reduce the door openings to 2 ft. 10 in., the standard for postal cars.

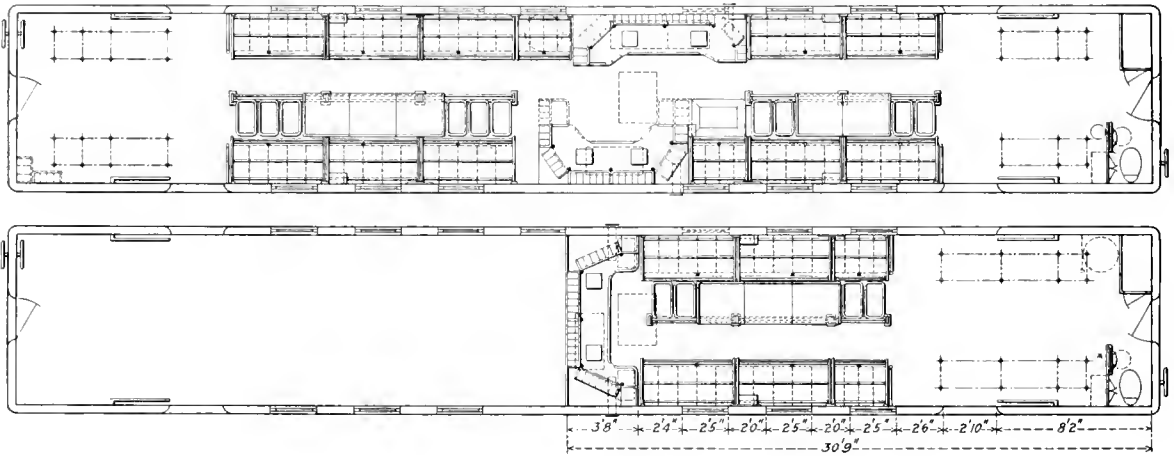

Plans for Converting the 60-ft. Mail Car to the 30-ft. Compartment Car

now permanently attached to the car body. It is also suggested that roads building 60-ft. postal cars which may at some future time be changed to 30-ft. apartment cars may make it easy to change one end of the cars into a baggage

Complete plans for the 15-ft.-30-ft. mail apartment are shown on Railway Mail Service drawing sheet M, while the plans for the 60-ft. mail car convertible to a 30-ft. apartment are shown on sheet N.

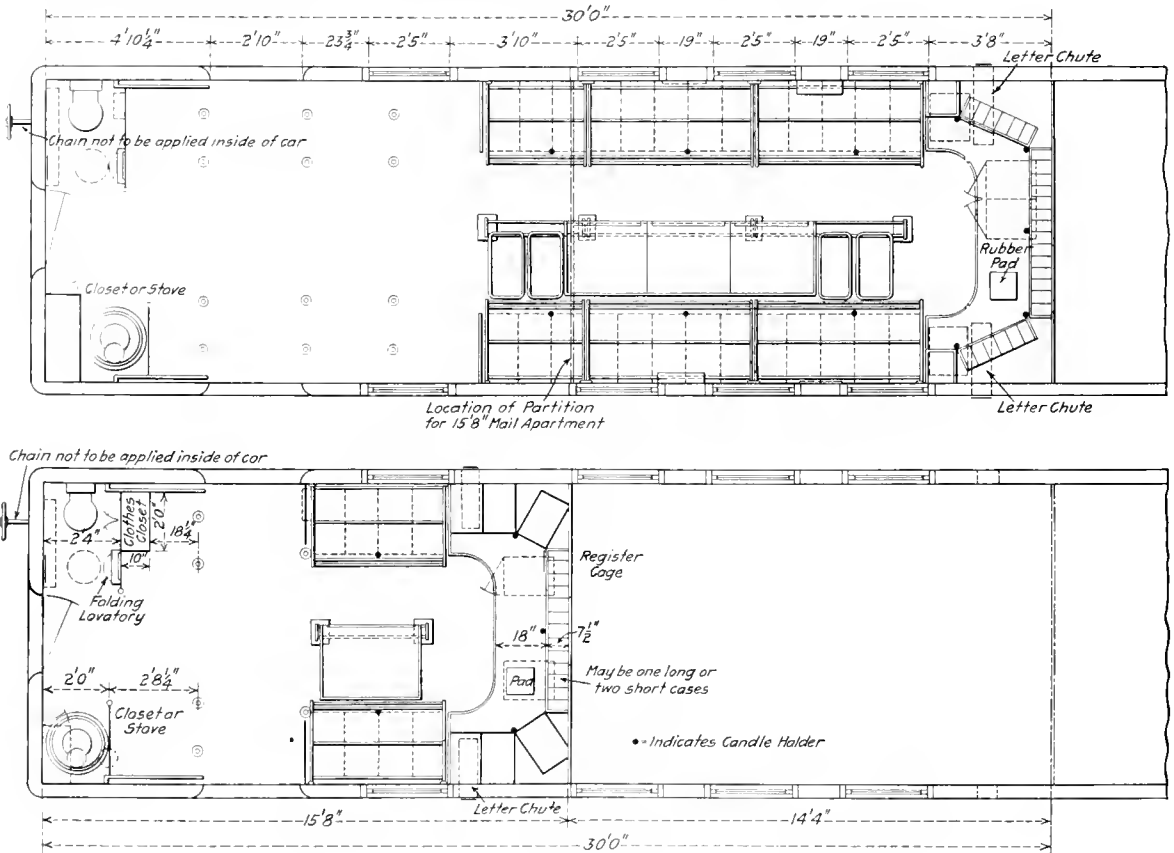

New Optional Floor Plans for 15-ft. and 30-ft. Compartment Postal Cars



SHOP PRACTICE



LOCOMOTIVE TERMINAL DELAYS*

BY H. T. BENTLEY

Superintendent of Motive Power and Machinery, Chicago & North Western

While the subject of this paper is Locomotive Terminal Delays, it might just as well be called "Keeping Engines Moving, or How the Round House and Shop Men Are Helping to Win the War." One of the vital needs of the country at this time is a prompt movement of engines from their arrival at the coal shed until they are ready for service again so as to handle properly not only the troops, but also the ammunition, grain, and other commodities that are just as necessary to bring the war to a successful ending as are the boys in the trenches.

I am not going into technical details, but will simply enumerate a few things that help to expedite engine movements at terminals. First of all the round house foreman must be a hustler and a good all around man, one who has the good will of the men. I believe the round house foreman is entitled to more of our consideration than is sometimes given him.

The following are some of the many good investments for a busy round house:

Coaling facilities that will coal engines quickly without spilling coal on the ground to be shoveled into cinder cars or otherwise wasted.

Clinker pits where cinders can be handled with the greatest despatch and the least amount of labor.

Sanding apparatus that will quickly deliver the sand in the box instead of on the boiler and the running board, and so located that the tender can be filled at same time.

Penstocks or water tanks properly situated so that if a number of engines are waiting to be coaled, the last engine in can get water without having to switch all of the others or wait until they are moved up past the penstock. In the case of a busy terminal, a separate penstock for switch engines is a great time saver. All spouts should be large enough so that no unnecessary delay occurs when taking water.

An engine washing device located outside with proper drainage so that water will be carried off to the sewer.

The turntable should be power operated and the tractor house so located that the operator can see the rails at both ends. A recent installation of a large table came to my notice where the operator could not properly see the rails at either end, making it necessary for two men to be employed where only one would have been needed if the house had been properly located.

It is hardly possible under present conditions to get along without having the use of oxy-acetylene and electric welding outfits in a round house. Numerous terminal delays can be saved with these outfits almost every day, especially in bad water territory where firebox and flue troubles are serious. The welding of flues does overcome delays and the extension of this practice should be considered, although we are told, that unless equipped with welding apparatus in the round

houses to follow the work up, there may be some difficulty experienced in case of leakage.

Labor saving devices of all sorts never were in such great demand as at present, and the men who were far sighted enough to equip their shops, engine houses, and engines with them are now reaping the benefit.

A portable electric light cluster with a reflector is a great help to a difficult night job; there ought to be one or more in every busy round house. For reducing terminal delays they are a good investment and easily made.

The dropping of wheels to replace driving box brasses and take up lateral motion is a big job, but with proper devices applied to your engine, much terminal delay can be overcome; we have recently had two engines come to the shops for the first time in five years for driving wheels to be removed. During that time, side play was taken up, new brasses applied and tires changed without dropping the wheels.

The hot water washout plant has been in service long enough to fully prove its usefulness in conserving coal, water and time.

The emptying of sand boxes to make repairs to sanders or to get rid of wet sand is the cause of lots of delays and profanity, both of which can be overcome by proper attention in shops by knowing that joints are water tight and using a sander that can be repaired from the outside without the necessity of emptying the box and spilling sand over the machinery.

The retaining of heat in a boiler, where such action can be taken, not only helps overcome delays, but conserves wood and coal, both of which are in great demand. In some tests made a few months ago, it was shown that it took about twice the amount of steam from the blower line to raise steam on an engine when cold, as compared with one with hot water in the boiler. We periodically talk about covering stacks and sometimes do it, but after a while the practice is dropped. We all know that heat, or its equivalent, dollars and cents, can be saved by covering the stack of a hot engine, then why don't we do it?

What delays can be charged up to an inadequate blower system, and why does not someone get up a device that will be effective and more economical? The condensation that takes place in a blower line from the boiler room, around the house and then to the locomotive is simply a waste of coal that some inventive genius should be able to overcome. A blower line is a good condenser, but not a very economical medium for steam raising.

The firing up of locomotives is a job that is done hundreds of times every day, and if any member has a method of doing this more economically and quickly than by the practice of using wood and coal and will tell us about it, we may be able to save some time or a few shovels of coal on each fire.

Men speeding up their work in the shops and round houses, and doing it well are just as much entitled to credit as people in other occupations who are doing their bit for this glorious country of ours.

The drawing office is sometimes responsible for delays in

* Abstract of a paper presented at the Western Railway Club.

round houses, and if the round house foremen were consulted more often by the mechanical engineer, many annoying delays due to poor design or inaccessible parts would be overcome.

It is possible that some of us are still doing some things that are not absolutely necessary, you might call them "frills." A short time ago we held a staff meeting at which this subject was discussed, and decided to postpone some things not detrimental to the service, until a more opportune time.

Engineers can save delays at the terminal by correctly reporting the work that actually needs doing; the work slip that shows a bad pound on the right side, or packing blowing without saying where, or the air pump not working, or

utilize the facilities we have to the best advantage to keep the wheels moving; by getting good results under those conditions we really are bigger and better men than if surrounded with every convenience for turning engines promptly. Difficulties bring out a man's resourcefulness, and the more difficulties successfully overcome, the more valuable is that man to his employers.

DISCUSSION

Some roads reported that at the present time the average service obtained from locomotives has been increased to 6,000 miles per month in freight service and 9,000 miles per month in passenger service. The practice of filling tenders not quite to the top has been adopted by one road to conserve coal and save labor at the terminal. The necessity for power operated devices for handling cinders was emphasized by one of the speakers, who told of a terminal employing eight laborers on this work, where it was necessary to hire 42 new men in a single month. Several roads were reported to be using stack covers; some are attached to the stack, while others are suspended by chains inside the smoke jack. It has been found necessary to have an opening from 2 in. to 4 in. in diameter in the cover to prevent the engine sweating. As an instance of the special methods used to keep power in service, a foreman at one locomotive terminal told how one-eighth inch was removed from the flanges of an entire set of drivers without dropping the wheels by means of a cutting tool attached to the frame of the locomotive.

Report of Delays to Engines in Terminal Service

Date _____ From _____ To _____

ENGINE	Arrived	Time Ordered	Departed	Total Delay	CAUSE OF DELAY

Foreman _____

Report for Recording Delays to Locomotives at Terminals

something wrong with the injector, causes lots of unnecessary work looking for a defect that should have been located in service and which in some cases is difficult to find on a dead engine. Coal can also be saved by the engine crew not coming to the clinker pit with a lot of green coal in the fire box, as it is only knocked out and wasted; we cannot afford to waste coal at any time, but now to do so is almost a crime.

The open sided clinker pit with a depressed track for cinder cars is standard with us, but with the present labor shortage it is a question whether there is not something that re-

STEAM HAMMER DIES FOR SUPER-HEATER FLUES

In shops which are not equipped with special machines for handling superheater flues the work of welding them is usually done by expanding the small end of the flue with a roller, swedging the safe end so that it will enter the flue and welding. At the Boone, Iowa, shops of the Chicago & North Western this work has been greatly facilitated by the use of a set of steam hammer dies which are illustrated below.

The dies are guided by the two studs in the upper die and are held about one-half inch apart by the helical springs in the recesses around the studs. The ends of the flues are brought down to the size of the safe end in the dies shown

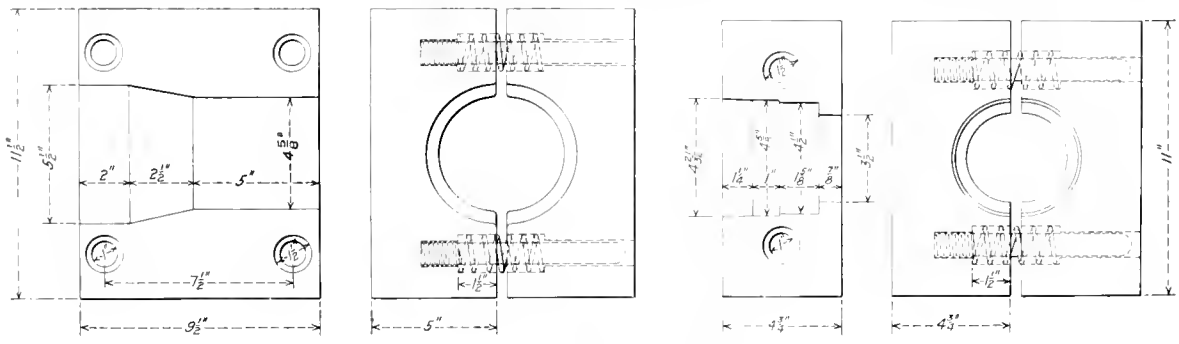

Dies for Swedging Superheater Flues

quires less labor and can handle cinders more economically.

A copy of our "Delays to Engines in Terminal Service" report is shown herewith, from which it will be seen that very little work is required to give information as to the total delay and the cause. The information given in these reports enables the master mechanic to put his finger on irregularities and correct them.

Most of us are able to say what we could do if we had all the improvements we might think necessary, but as it is impossible to get some of those things now, it is up to us to

on the left, while those on the right are used to swedge down the safe end so it will enter the flue for a distance of about 1 1/2 in. The superheater flue is heated before the safe end is inserted so that it makes a tight fit after it has cooled. The safe end is then welded to the flue by the oxyacetylene or electric welding process.

One of the principal advantages of this method lies in the fact that the flue will not give way even though the weld may be defective, due to the considerable overlap of the flue and the safe end.

PLAIN CYLINDER GRINDING WORK

Grinding Machines in the Shop Can Handle Some Classes of Work Better and Quicker Than the Lathe

BY A. B. C.

PLAIN cylindrical grinding machines are now being installed to a limited extent in railway shops and they have been found to be very useful and economical tools. For finishing a number of articles used in locomotive manufacture or repair work, such as cross-head pins, crank pins, piston rods and other parts, it has been found that a better finish can be obtained at less cost than by turning, filing and using emery paper.

Grinding does not appeal to railway people as it does to makers of machine tools and automobiles for the reason that locomotive parts are generally made only in small quantities and the finish need not be equal to that given parts of salable articles, especially where the finish is a selling point. However, as the grinder has proven an economical machine in most branches of manufacture, it will no doubt come to its own in railway work.

Some of the early attempts at grinding in railway shops were not entirely satisfactory due to the fact that the machines were too light and that an improper grade of grinding wheels was used. Later experience has indicated that plain grinding machines for railway work must be heavy and designed so that metal may be rapidly removed, and that the grinding wheels must be of proper grade and grain in order to cut properly and quickly and give the material the finish desired. Recent developments in grinding wheels and appliances for truing them have shown that the same wheel can be used to cut or remove the metal rapidly from any of the various locomotive parts and, after the wheel has been quickly trued with the diamond, satisfactorily finish it with generally superior results than can be obtained by methods where grinding machines are not employed. The experience on universal tool room grinders which are common in all shops does not apply to plain grinders for locomotive parts, the tool room grinder being a small machine and intended only for taking light cuts, whereas for locomotive parts a machine capable of quickly removing metal and producing a smooth finish is essential.

The plain grinding machine that can be recommended for locomotive parts should have ample weight and strength to run grinding wheels with a face of from $1\frac{1}{2}$ in. to 2 in., to their limit. Such a machine will absorb 10 to 15 hp. With some of the heavier plain cylindrical grinders one to two cubic inches of metal can be removed a minute, and with the same wheel properly trued or dressed, a very satisfactory finish can be obtained. The plain machine made by a number of concerns known as 12-in. by 36-in. size is very satisfactory for all work not over 36 in. long and having a diameter up to about 10 in. This machine can be used for crank pins, knuckle pins, crosshead pins, link motion pins and practically all locomotive parts where a running finish is necessary, excepting valve rods, piston rods and axles. This size has ample strength to cut rapidly and produce a good finish. Smaller machines are liable to fall short of requirements and be disappointing. It should be remembered that a grinding wheel is only a circular cutter having a multitude of cutting points. If the machine is strong and the work well supported, the wheel will cut rapidly, but if the machine is weak or the work not properly supported, the work will spring away from the wheel and it will not cut rapidly nor produce a desirable finish.

Grinding machines are economical where it is the prac-

tice to make new and repair parts for locomotives to a semi-finished state on automatic machines, turret lathes or center lathes. When fitting parts made to a semi-finished state it will generally be found that the articles can be fitted and finished more quickly by grinding than by turning, filing and using emery paper.

A few examples of grinding from a semi-finished state are given below:

Crosshead Pins.—These are blanked out to from $1/32$ in. to $1/8$ in. large on the straight and taper surfaces, threaded, keyways cut, etc. When it is desired to fit the pin to the crosshead, the straight portion of the pin is ground with the table set for straight grinding and the tapered portion of the pin is ground with the machine set to the proper taper. When the holes in each side of the crosshead have been reamed at the same time with a single taper reamer, as is generally the case on new work, one end of the pin can be ground about to size and the micrometer dial or stop on the cross feed of the machine set. Afterwards the wheel is shifted to the other end of the crosshead pin and the wheel fed in to the stop. This will insure a proper taper to the pin. In the case the two tapered holes of the crosshead are not of the same taper, owing to unequal reaming, which may be the result of repairs, each end of the pin must be fitted separately. Where the surface to be ground is shorter than the width of the grinding wheel, it is often good practice to feed the wheel directly on to the work without giving it any lateral motion. The latter method can often be followed on the taper ends. Crosshead pins should be carefully finished both for the bearing and the fit in the crosshead. To obtain this finish it is desirable to true the wheel frequently, as will be explained later. The ground surfaces when properly finished are superior to surfaces finished by other methods and the time and cost of doing the work will be found to be less than if the work was done on a lathe.

The grinding machine is very useful when it is necessary to refinish a cut or a worn crosshead pin, as a new surface can be produced by removing a minimum amount of metal.

In fitting worn crosshead pins to other crossheads having holes smaller than the pin, the grinder will be found very useful. In most cases the pin can be fitted and finished quicker on the grinding machine than on the lathe, even though there is a considerable amount of metal to remove. Where conditions will justify, it is advisable to blank out the pins in various sizes, say in steps of $1/8$ in., so that they may be fitted to worn crossheads with but a small amount of grinding.

Side Rod Knuckle Pins.—The practice recommended for the grinding of knuckle pins is similar to that for crosshead pins. Some roads make a practice of casehardening these parts. Where this prevails the pins can be made in quantities, with about $1/32$ in. being left for finish on the straight and taper fits on new work and possibly $1/8$ in. on repair work, the keyways being cut, the holes drilled and the pins casehardened. When it is necessary to fit them to the rods, the straight portions of the pin can be ground to size which will not go below the casehardening, if they are properly pack hardened. The taper ends are then ground to fit the rods. As the casehardened surface on the taper portions is not essential, going below the hardened surface will not affect the wearing qualities of the pin. By follow-

ing this practice a supply of knuckle pins will be on hand ready for fitting to the rods without delay and the pins will be better finished than where the old practice is followed. The warping or distorting of the pins when being case-hardened will as a general rule prevent making a satisfactory fit in the rod or in the knuckle pin bushing unless the pin is ground. Where these pins are not hardened the method of finish would be similar to that for cross-head pins.

Link Motion Pins.—These are small additions to those mentioned above. Where they are case-hardened it is, of course, desirable to grind them in order to obtain proper running fits in the bushings. It will often be found that worn pins can be refinished by grinding to fit other arms without annealing.

Air Pump Piston Rods.—New air pump piston rods can be finished economically by blanking them out about 1/64-in. large and grinding. Where rods are worn or scored they can be very quickly ground true with the removal of the least possible amount of metal necessary to true them.

Crank Pins.—Grinding crank pins is ordinary straight work that can be very readily done on a plain cylindrical or gap grinder such as is used for piston rods. When blanking these out on the lathe or turret machine it is advisable to finish the sides of the collars as the present construction of grinding machines is not well adapted to grinding on the sides of the wheel, also it is difficult to properly true the wheels on the sides. It is to be hoped that some of our wheel makers will develop a grinding wheel suitable for grinding on the sides of the wheel for uses similar to that of making crank pins. The lathe work, with the exception of the collars, can be done with the coarsest feed it is possible to take, about 1/32 in. of the diameter being left for grinding. Both the bearings and the wheel fit can be ground economically.

Piston Rods.—A special gap grinder has been developed which is used largely for the grinding of piston rods, the machine having a gap in the bed large enough to swing a piston rod with its head mounted. These machines are used for finishing new piston rods that have been turned previously about 1/32 in. large. Two methods have been used for repairing rods, one being to take a light cut on the lathe and the finishing cut on the grinder, but it has generally been found more economical to do all the repair work required on the rod on the grinder, no matter how badly it may be cut or out of true. With proper wheels and plenty of steady rests, the worst kind of worn rod can generally be refinished in less than 30 minutes and only slightly worn rods in much less time. Some of these gap grinders for piston rods are operated without steady rests; this will not result in obtaining the full output of the machine, however. For rapid grinding and good finish at least three steady rests should be used, these to be gradually adjusted to the rod as the diameter is reduced. Piston rods are from four to six feet long and must be supported to prevent them from springing away from the wheel. Much of the rough appearance of ground piston rods can be attributed to a lack of support for the rods. Probably there is no one part of a locomotive to which grinding is better adapted than the piston rod. With reasonable care the rods can be ground to one size from end to end to within a limit of .001 or .002 in.

Valve Stems.—These can readily be ground on the piston rod gap grinders.

Locomotive Axles.—These being large in diameter and heavy, require large grinders and for a new installation the size known as 20-in. by 96-in. is desirable. The journals and wheel fits may readily be ground on machines of this size. Axles should be roughed to about 1/32 in. above the required finished dimension. The customary gap grinders used for piston rods can be used for axle grinding. As a general rule they are somewhat light for the work; how-

ever, where the work on rods is not sufficient to keep the machine busy, axles or crank pins may be ground on these machines to good advantage.

Choice of Grinding Wheels.—In the early days of commercial grinding there was a difference of opinion as to the kind of grinding wheels to use. By some a wheel that would give long life was considered the more desirable. Later practices and knowledge of grinding wheels have shown that while long life is desirable, the latter can be sacrificed for good cutting and finishing qualities; also that a wheel desirable for railway work is one that will wear away at a moderate rate. As previously stated, a grinding wheel may be likened to a circular cutter having a multitude of cutting points. These points will eventually dull and clog from chips gathered from the work. If the wheel is moderately soft the dull points will break away and present new sharp points. A hard, fine wheel, however, will glaze and refuse to cut with the speed desirable for locomotive work. For steel such as is used mostly on locomotives, running about 0.40 per cent carbon, wheels classified by the Norton Company as grade M-36 vitrified, or corresponding grades made by other concerns will generally be found a good compromise and can be used on most locomotive work, especially for general locomotive repairs where one grinder is often used for soft steel and case-hardened parts, and where frequent changing of wheels would consume too much time. Where a large number of one article is to be ground at one time, it is, of course, desirable to use different wheels for soft steel, case-hardened steel, cast iron, etc., and possibly one wheel for roughing down and a second wheel for finishing.

Truing Wheels.—Brown & Sharpe milling cutters and those of other makers used to be marked, "Keep the cutter sharp." The same should apply to grinding wheels. The only suitable medium for truing and sharpening a wheel is the diamond. It should be used on all plain cylindrical grinders used in railway work. Diamonds can be purchased for \$10 to \$15 and will last a long time. For jobs such as piston rods, crosshead or crank pins, etc., it is always desirable to grind close to size and true the wheel for the final finishing cut. Truing the wheel takes only a fraction of a minute with the devices for holding the diamond supplied with machines. With a moderately coarse wheel properly trued, a finish can generally be produced that answers all requirements for locomotives.

Cooling Compounds.—Grinding wheels should, of course, be flooded with a cooling compound to prevent heating the work and clogging the wheel. A number of compounds are recommended by the makers of grinding machines. These contain ingredients that prevent rusting of the machine and work. A good grinding compound should always be used; clear water is not satisfactory for this class of work. The nozzle for the cutting compound should be adjusted as close as possible to the point of contact of the wheel and work. No damage will result from too much cooling compound, but bad work will result from too little.

Steady Rests.—Particular attention is called to the value of steady rests. As many as possible should be used in order to prevent the vibration of the work. Even with an article as large as a crank pin one or two rests are desirable.

Feeds.—For roughing down it is generally recommended that the feeds be set to traverse the work in front of the wheel about three-quarters of the width of the wheel for each revolution of the article being ground. It must be remembered that a grinding wheel reduces diameter only at each revolution of the work, a very small amount, rarely over .002 in. This thin layer or chip if spread out to 1½ in. or 2 in. will remove metal fairly rapidly. Grinding can be done much more quickly by a coarse than by a fine feed.

Previous Machining.—Where the practice of grinding is followed, the finish given articles in the lathe or turret

machine can be of the roughest character, thus saving the time taken to provide the smooth surface with a fine feed. A modern grinder will remove the rough surface much cheaper than taking the time to turn it off in the lathe.

Attention to Machine Tool Equipment.—A grinding machine will generally take the place of a lathe in any fair sized railway shop and it costs about the same. Therefore, when additions are necessary the plain grinder should be carefully considered.

Operators for Grinders.—Grinders require good operators who have knowledge of proper measuring and who will take advantage of short cuts and kinks to perform the work quickly and satisfactorily. However, a good lathe hand will generally make a good grinder hand. Given two inexperienced men, one to operate a grinder and one to operate a lathe, the prospects are that the man on the grinder will learn to produce a satisfactory job much sooner.

A TIME-SAVING ATTACHMENT FOR THE PLANER

A handy device used in the Dale Street shops of the Great Northern for planing balance plates of valve chest covers is shown below. A view of the attachment in use is given in Fig. 1, while Fig. 2 shows the dimensions of the parts. The



Fig. 1—Method of Planing Valve Chest Covers

four brackets are forged from mild steel and finished to the dimensions given, care being taken to get the surface marked *B* parallel to and the same distance from the base *A* on every bracket. The brackets are attached to the planer as shown and the steam chest cover to be planed is slipped into position

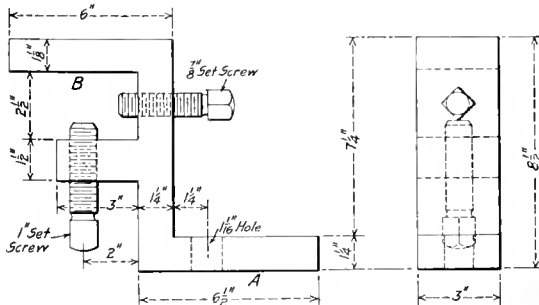

Fig. 2—Details of Brackets for Holding Valve Chest Cover

and the vertical set screws are tightened. This holds the joint surface of the cover against the bracket and brings it parallel with the planer table. The horizontal set screws bearing on the corners keep the cover from moving in the brackets. This attachment makes it unnecessary to use a surface gage when planing balance plates, thus saving considerable time on the operation.

HIGH SPEED STEEL TIPPED TOOLS

BY M. C. WHELAN

Blacksmith Foreman, St. Louis & San Francisco, Kansas City, Mo.

To apply successfully high speed tips on tire steel tool bodies for machine tools has been found quite difficult. The method described below has been used by the writer for some time with success, the tips remaining on the tool body until they are worn away. When the welding of high speed tips on machine tool bodies was first attempted in our shops, it was found difficult to weld a tip on a tire turning tool that



Tool for Forming the High Speed Steel Tips.

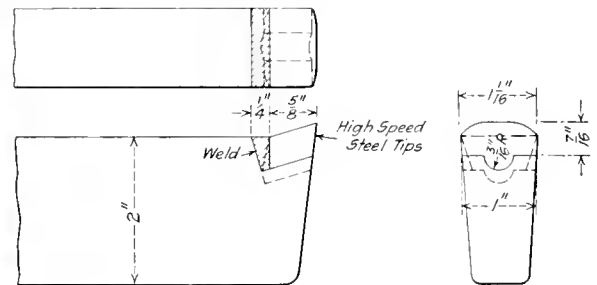

Method of Applying High Speed Steel Tips to Lathe Tools

would last for any length of time, no matter how well the weld was made, on account of the vibration and the great side pressure on the tool when heavy cuts and feeds were taken. The weld used was a flat surface weld. After some experimenting the tongue and groove method illustrated in the sketches was tried and it proved successful. This design not only holds the high speed steel tip in place, prevent-

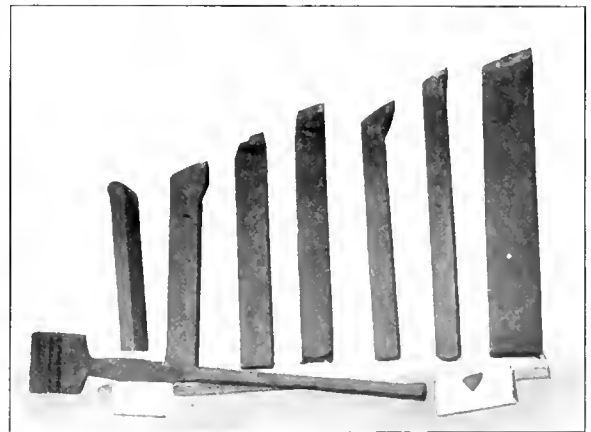

Assortment of Tools Provided With High Speed Steel Tips

ing it being broken off or loosened, but does not require as solid a weld. By taking care not to make the tips too long and by tapping the tips well into the body of the tool, having it seat properly, it is only necessary to weld the back of the tips as shown.

The small steam hammer tool shown in the sketch also is

used for forging the tips from the high speed steel scrap. We use three sizes, viz.: $\frac{3}{4}$ in., 1 in. and $1\frac{1}{2}$ in. wide for the various sizes of tools.

The photograph shows a number of lathe and planer tools. The picture was taken after they had been in service for some time. The largest one had been used along with one other of the same size in turning 36 pairs of driving wheels. In applying the tips the welding must be done by those who can do it properly.

ELECTRIC WELDING INSTRUCTIONS

BY E. WANAMAKER
Electrical Engineer, Chicago, Rock Island & Pacific

Some of the equipment now on the market assures the practicability of electric welding and the perfectness of the job, provided the person doing the welding has thoroughly learned his trade.

Contrary to the opinions held by many, it is far from a simple process and it will take an operator approximately one year to become a fairly proficient welder on all classes of work, such as would ordinarily be found on a railroad and only at the end of approximately three years will he become expert and then not unless he has studied and worked under the direction of a competent instructor and demonstrator.

The choosing of electric welding equipment should only be entrusted to some person thoroughly familiar with electrical principles, welding and general boiler and machine designs. This done, and the equipment properly installed, the next step is the instruction and breaking in of welding operators. The following are the vital points which it is necessary to master before really successful welding can be accomplished:

1. The operator should be taught all the details of preparing different kinds of work for welding.
2. The proper current strength and size of electrode for the job in hand should be selected. This automatically regulates the speed to that which is most desirable for that particular class of work. Also, special electrodes are necessary for a few certain classes of work and are well worth the extra or additional price necessary to obtain same; however, the special jobs would probably not exceed 2 per cent of all welding done.
3. The study of strains and stresses is the most interesting as well as the most important of all steps connected with the welding art. The preparation of the parts for welding and the proper flowing of the metal are comparatively easy to learn; provided, good equipment and welding electrodes are used. It is, however, self evident that if the problem of strains and stresses is not properly taken care of, failure will occur either in the weld itself or at some weaker point or part of the object welded. It is to be hoped that much attention will be given this point by those interested in electric welding in order that we may benefit by the enormous savings that can be effected by the intelligent use of the electric welding arc.

OPERATING AND MAINTENANCE

Installations of electric welding equipment on the Rock Island are designed and made by the electrical department. The division electricians at the point where welding installations have been made are given sufficient instruction to enable them properly to operate and maintain the equipment, being supplied with references for ordering any repair parts that would eventually be required. As soon as possible after the installation has been completed, the supervisor of electrical equipment, accompanied by an expert demonstrator from the manufacturer visits the point and instructs as many men as deemed necessary in the use of the electric arc. As is evident, these instructions are only preliminary and it is

intended to continue giving instruction as frequently as possible in order to realize the full benefit from the equipments.

A complete set of instructions for electric welding has been issued. These begin with an explanation of the electric arc itself, continuing with the proper polarity for different classes of work. The next point covered is the amount of heat used, the kinds and sizes of electrodes and the current and voltage for the different classes of work. Immediately following are the instructions for all kinds of fire-box welding, including the proper use of protective shields. This in turn is followed with complete instructions on the proper methods to use in welding frames and cylinders, and in all building-up operations.

The proper preparation of the work is fully as important as the welding operation, if not even more so. The instruction book supplies detailed sketches showing the proper method of preparing work for welding, including a detail of a small portable sand blast. Several pages are devoted to the properties of iron and steel, in order that welding may be intelligently accomplished. In conclusion, there is a long list of locomotive and car parts, machine tool parts, etc., which it has been found can be successfully and economically welded.

There seems to be practically no limit to the application of electric welding when a good welding machine is intelligently used by a competent operator who thoroughly understands metals as well as the handling of the arc. The results up to the present time indicate that the net returns from the electric welding installation will be far greater than had been anticipated.

METHOD OF TESTING VALVES

BY J. A. JESSON

A simple arrangement for testing air pump and steam heat governors, etc., consisting of a bracket made of $\frac{3}{4}$ -in. by 4-in. bar iron with pipe connection, rubber gaskets and a handwheel for covering the end of the valves is shown in the illustration. The $\frac{3}{4}$ -in. pipe at the right supplies

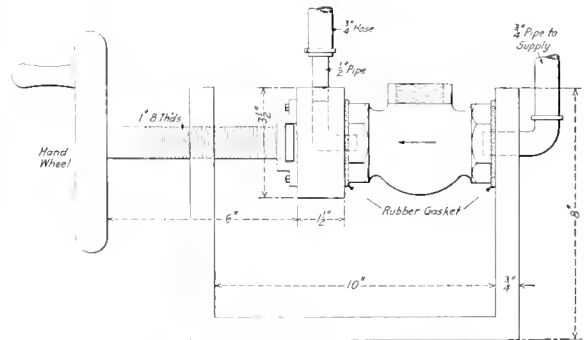

Device for Giving Valves a Pressure Test

the air for testing, and the hose connection at the left leads to a reservoir in which is placed a test gage. Rubber gaskets are placed on each face of the valve to prevent leakage, the left hand valve head being forced against the valve by the handwheel and screw as indicated by the illustration.

EXPRESS PACKAGES BY AEROPLANE.—The Triangle Distributing Corporation, on October 11, sent a package of films from Buffalo, N. Y., to Rochester, by aeroplane, the shipment having missed the last train by which it could have reached the consignee in season for the afternoon exhibition. The flight, 70 miles in 45 minutes, was made by Roland Rohlf, of the Curtiss Aviation Training School.

DESIGN OF FORGING MACHINE DIES*

Fundamental Rules Are Given and Explained Which Should Be Followed Where Good Results Are Desired

BY E. R. FROST

General Manager, National Machinery Company, Tiffin, Ohio

It is our experience that at least 75 per cent of the failures in forging machine die design can be attributed to the disregard of one or more of the fundamental laws pertaining to this work. The desirability of having this information expressed in the form of laws makes the excuse for this paper. Throughout these remarks the policy is followed of not taking into consideration unusual methods; trick heats; welding operations; or, in fact, any laboratory meth-

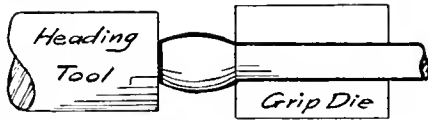

Fig. 1

ods which, while possible under certain conditions, are impractical in average shop practice. Consequently, while certain statements may appear to be too limited, they will, in the main, be found as applying to average conditions.

It is possible to classify the majority of forging machine die problems under three rules or headings.

Rule 1.—*The limit of length of unsupported stock that can be gathered or upset in one blow without injurious buckling, is not more than three times the diameter of the bar.*

As an example, if the diameter of the bar to be upset is 1 inch, then the length of unsupported stock which may be successfully gathered, cannot be more than 3 inches. This rule applies on all diameters of stock. As three diameters, however, is practically the limit, it is best to keep the actual working limit within two and one-half diameters; and where it can be done, even a limit of two diameters is better, as then



Fig. 2

less attention need be paid to the squareness of the end of the bar. On such upsets, as the heading tool advances, as indicated in Fig. 1, the stock will swell uniformly in all directions from the axis of the blank, and it can be carried to practically any thickness without any serious tendency to upset unevenly. It is immaterial whether the stock overhangs the face of the gripping dies, or whether part of the stock is gathered in the gripping dies and part in the heading tool, whether it is all upset in the gripping dies, or all in the heading tool,—the fact must be kept in mind that such conditions represent cases where the stock is unsupported, and hence Rule 1 applying to three diameters or less of unsupported stock will apply.

In order to prove the dependability of Rule 1—if an effort is made to upset a length of stock longer than three diameters, in place of upsetting uniformly, as shown in Fig. 1, the stock will buckle at a point near the middle, and result in more of the upset forming on one side of the center of

the bar than on the other. As an example: Assuming that the diameter of the bar is 1 inch, and the length of unsupported stock 4 inches, then when the heading tool advances, the stock will start to buckle, as shown in Fig. 2, and after it has once started, will, of course, continue.

It is impossible to correct this condition by varying the point in the die where the upsetting takes place. The stock will buckle, regardless of whether it is upset in the gripping dies, in the heading tool, or part in the gripping dies and part in the heading tool.

Rule 2.—*Lengths of stock more than three times the diameter of the bar can be successfully upset in one blow, provided the diameter of the upset made is not more than one and one-half times the diameter of the bar.*

This rule, while fairly well recognized, requires a clear understanding in order to develop its practical possibilities.

Referring to Fig. 3; assuming that the diameter of the bar is 1 inch, and the length of stock to be upset is 6 inches,

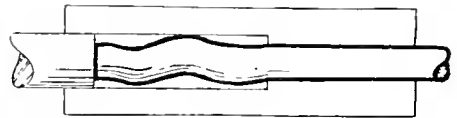

Fig. 3

and that the diameter of the hole in the die is not more than $1\frac{1}{2}$ inches, then when the upsetting begins, the stock will at once buckle, but on account of the limited diameter of the hole the stock soon comes in contact with the sides of the die. This prevents further buckling in this direction, hence any additional upsetting must take place at some other point. The stock will frequently be found to buckle at several points, as in Fig. 3; but as the heading tool advances, the stock will gradually fill the impression in the die, the only objection being a fin around the end of the upset.

If an attempt is made to produce a forging in a die in which the diameter of the hole in the die is greater than one and one-half times the diameter of the bar, then when the upsetting begins the buckling effect at some point—and generally near the middle of the unsupported stock, such as at "1" in Fig. 4—is sufficient so that when the heading tool continues its advance, the stock on the opposite side from

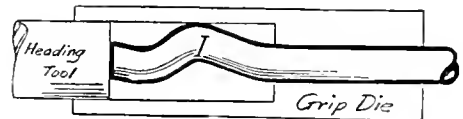

Fig. 4

the buckled portion will fold in, and, of course, leave a defect in the upset.

As in the case of Rule 1, while it is possible to make forgings in which the diameter of the opening in the die is as much as one and one-half times the diameter of the bar, nevertheless, this is very close to the limit, and in practice it is much better to keep the diameter of the upset not more than 1.3 times the diameter of the bar.

The practical application of this law is in the ability to

* Read before the Fourth Annual Convention of the American Drop Forge Association at Cleveland, Ohio.

gather large amounts of stock by repeating the principle, as indicated in Fig. 5. In the first, or top impression, the diameter K of the recess in the die is not more than one and one-half times the diameter of the bar L . In the second impression, the diameter of the recess M is not more than one and one-half times the diameter of the previous upset N . In the last impression, the length of the upset O is well within the limit of Rule 1 regarding unsupported stock, so that no limit need be put on the diameter P of the last die impression. In such upsets, where the length of stock in

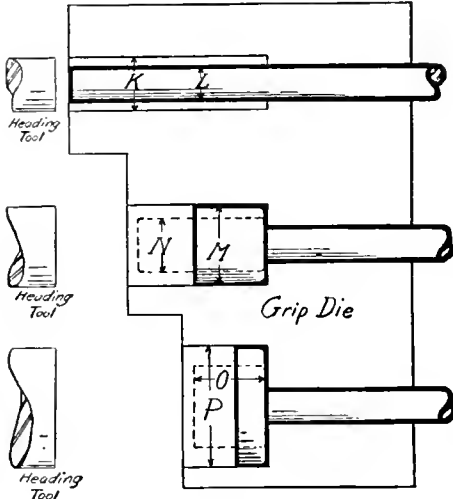

Fig. 5

the first operation is excessive, it is generally necessary to keep the end of the bar at a lower temperature.

Where it is desirable to carefully hold the size of some upset in which the stock requirement is not materially over three diameters in length, if the diameter of the impression in the die is made not more than 1.3 times the diameter of the bar, as in Fig. 6, then the upset formed will be free from fins on the end of the upset, even if no special care is taken in heating. This is on account of the fact that

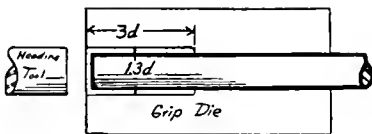

Fig. 6

where the length of the stock is not more than three diameters, the upsetting takes place quite uniformly throughout its length, and any buckling being limited, the friction of the stock along the side of the die does not become a factor.

In handling all upsets requiring more than three diameters of stock, the fact must always be kept in mind that the stock will first start to buckle at the middle of the unsupported portion, and as a result, somewhat more than one-half the stock to be upset must be inside of the impression in the die. It can equally well be in a taper or straight hole in the heading ram; but it is useless to attempt to make part of the impression in the gripping die, and part

in the heading tool, because when the up-setting begins, as in Fig. 7, the stock will buckle, leaving a defective forging.

Among the various ways to reduce the number of operations required to make large size upsets on small diameter bars, attention is called to the square hole scheme as shown in Fig. 8. Here an extra amount of stock is obtained in the

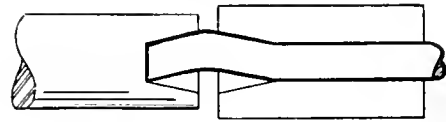

Fig. 7

first upset by making the first impression square, in place of round. The short diameter of the square hole, as at R , is made within one and one-half times the diameter of the bar. Consequently, the sides of the square impression in the die support the bar, and keep it from buckling; but the greater area of the square hole enables a larger amount of stock to be gathered than would be possible were the hole round. The next impression is made round, and the diameter of this impression, as at S can be one and one-half times the long diameter, or in other words, the diameter across the corners of the previous square upset. The square cor-

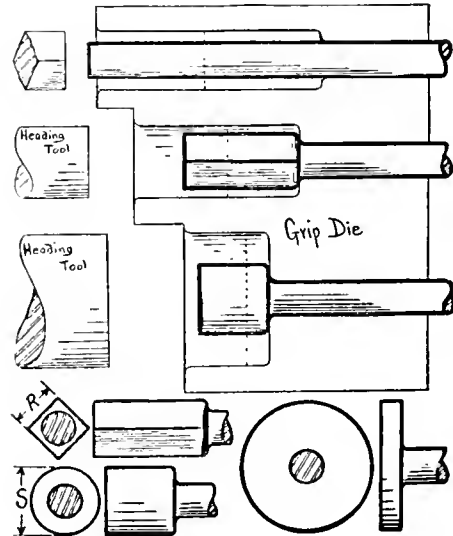

Fig. 8

ners, by coming in contact first with the sides of the die impression, also prevent the bar from buckling and allow a large amount of stock to be gathered. If the length of the stock as it leaves the second operation, has been shortened sufficiently to come within the requirements of Rule 1, then it can be formed in the last operation into any desired shape without regard to the diameter of the die impression.

Another method of increasing the amount of stock that can be gathered in one operation, is to keep the diameter of the impression in the die within the limit of Rule 2 for a distance of slightly more than one-half of the length of the stock, as indicated at T , Fig. 9, but then to increase the size of the opening as shown. When the heading tool begins to upset the stock, it will, of course, buckle at T , but being supported by the die at this point, and by virtue of the fact that the friction along the side of the die will cause the forward end to upset first, the stock will gradually carry back in the die and produce a uniform upset.

As the chuck screw is tightened the box is centered, and after it has been set to give the desired depth of cut in the crown of the brass the vertical set screws on the jaws are tightened. This holds the box securely and it can be bored and faced in one operation.

LUBRICATING AIR CYLINDERS OF CROSS-COMPOUND TYPE AIR COMPRESSORS

BY J. H. HAHN

Machinist, Norfolk & Western, Bluefield, W. Va.

Some trouble has been experienced in devising a successful method of lubricating the air cylinders of the cross-compound type of air compressor. A connection from the hydrostatic lubricator is not advisable on account of the condensation that would be carried into the cylinders, thence to the main reservoir and finally to the brake system.

With a view of furnishing a suitable lubricator for lubricating the air cylinders of the cross-compound type of compressor that would eliminate the objectionable features of the hydrostatic lubricator and the hand oilers, the pneumatic lubricator shown in the sketch was designed. All parts of this lubricator can be made in the ordinary railroad shop at little expense. The oil reservoir can be made of a piece of pipe of suitable size (depending upon the number of feeds). Wrought iron or copper pipe can be used.

On compressors equipped with metallic piston rod packing it is necessary to have a four feed lubricator. The special choke fittings are used in the main reservoir pipe,

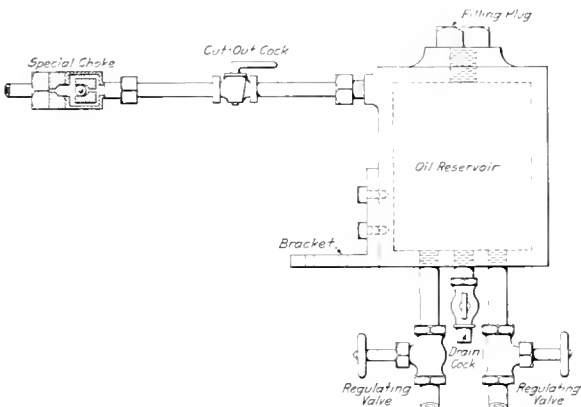

Lubricator for Cross-Compound Air Compressors

also in the pipes to the high and low pressure air cylinders. No chokes are used in pipes to the piston swabs. The regulating valves are 1/4-in. needle valves of the usual design. The cut out cock in the pipe from the main reservoir to the oil reservoir should be closed before the air is drained out of the main reservoir, otherwise some of the oil may escape by the special choke and go into the main reservoir. This cut out cock should also be closed when there is pressure on the main reservoir and if there is any occasion to remove filling plugs, etc.

The pipe at the upper left hand corner is connected to the main reservoir and carries air at main reservoir pressure to the oil reservoir. The air pressure insures that the oil pipes and passages remain open. Cold weather has no effect on this lubricator and the amount of condensation that goes into the cylinders is reduced to a small percentage. By regulating the needle valves, the desired amount of oil can be delivered to the cylinders. The special choke fitting was designed to use on the high pressure air cylinder, however, it can be applied to all connections where required.

The lubricator is attached by two of the 3/4-in. T-head bolts in the steam head of the pump. No dimensions are given as the installation of the lubricator has to be governed by conditions. In some instances it is desirable to use one lubricator for two pumps and in other cases a separate lubricator for each compressor is required, etc. The special choke fittings are made in two parts and about a 1/4-in. ball is used.

JIGS FOR PLANING OUTSIDE OF CROSS-HEAD SHOES

BY LOCKO WALKER

Asst. Machine Foreman, Oregon-Washington Railroad & Navigation Company, Portland, Ore.

Before these jigs were made it used to take us a good six hours to plane four crosshead shoes on the part that fits in the crosshead. Most of this time was consumed in setting up the shoes and trying to keep them from slipping around

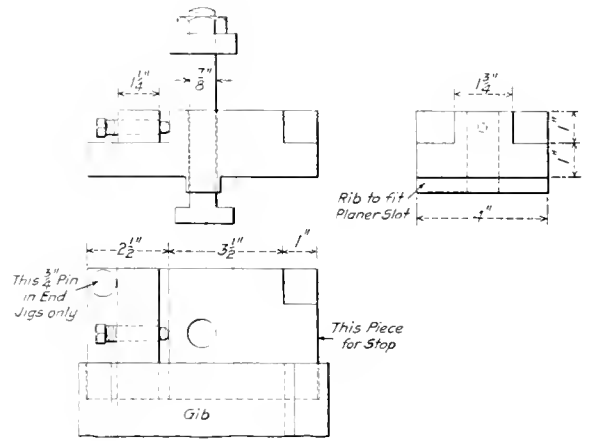

Jig for Planing Crosshead Shoes

under the strains of the cut, but with this jig it is possible to finish entire outside of four shoes in less than three hours. The setting up of these jigs is simple. Place the jigs, with the tongue in the slots, in a row, having a bolt long enough

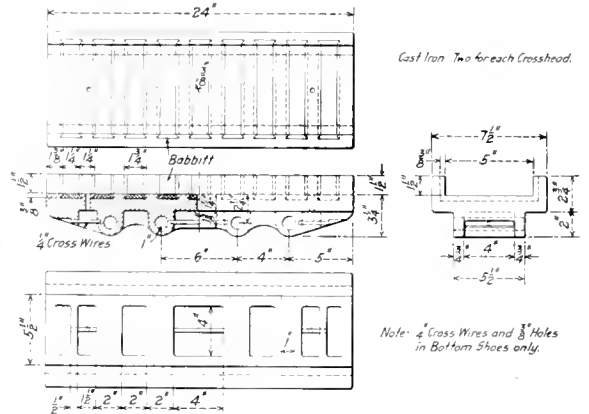

Type of Shoe for Which the Jig is Used

to allow for clamp, run up through jig. Place the shoe on the front jig and pull the second jig up so that the stop on the jig hits the back end of the shoes. Set up the rest of the shoes in the same manner, working from the front.

Then with a socket wrench tighten up the set screw in the loose pieces to prevent side play and then by merely putting the clamps over the bolts and tightening them down with nuts, the shoes are ready for any cut the planer will pull, with both heads cutting.

The jigs are made from scrap found about railroad shops and they will pay for themselves in the planing of eight gibs. Five shoes are required for four shoes.

BORING EQUALIZER BRACKETS IN PLACE

It is the practice on most roads to remove equalizer brackets from the frame whenever it becomes necessary to true up the holes and apply bushings. Where the brake hanger pin hole is in line with the equalizer pin the work can be

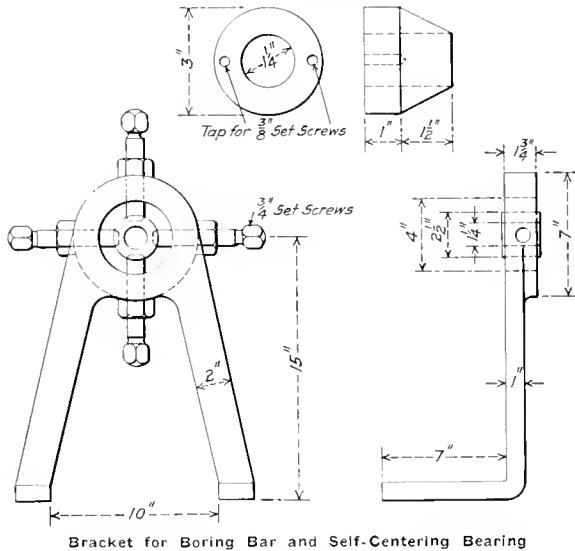

greatly facilitated by an attachment for boring the bracket in place which has been developed at the Boone, Iowa, shops of the Chicago & North Western. The device is shown in

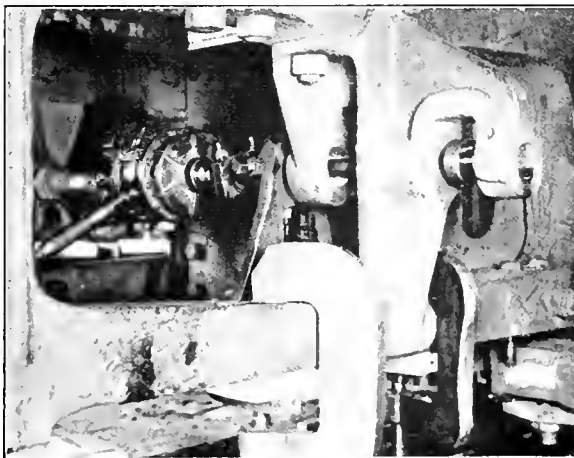

Truing up the Holes in an Equalizer Bracket

use in the illustration below. The cutter bar is driven by an air motor being supported inside the frame by a bracket attached to the lower frame rail by C-clamps. The bearing

in this bracket can be adjusted by means of set screws to bring it in line with the center of the hole. The outer end of the cutter bar is held in place by a bearing, one end of which is tapered at an angle of about 60 deg., so that it is self-centering. The tapered bearing is held securely in the brake hanger pin hole by means of set screws. A wooden collar is clamped on the cutter bar so that it maintains a contact with the inner bearing and slides on the bar as the tool is fed forward by the lead screw of the motor, thus preventing the tool from digging into the work.

CLEAR VISION WINDOWS

BY JOHN H. NAGLE
Chief Draftsman, Buffalo, Rochester & Pittsburgh

To meet the requirements of the Interstate Commerce Commission, that road locomotives used where snow storms are generally encountered shall be provided with a "clear vision" window at the front and so constructed that they may be easily opened or closed by the enginemen—the Buffalo, Rochester & Pittsburgh has designed a neat and suitable arrangement which is placed in the front doors of all cabs.

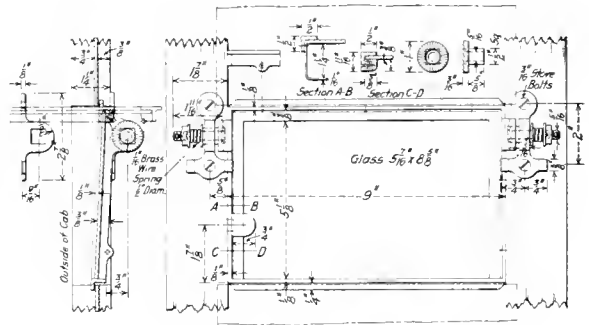

Clear Vision Windows for Wooden Cab Doors

The design is suitable for either steel or wood frame doors.

The clear vision glass frame is of light construction, either of cast brass or malleable iron, but preferably of brass, and is held in the open or closed position by means of a clutch and spring, the clutch being made with small teeth. This also keeps the window in any position desired, while the springs may be adjusted to keep the teeth properly engaged.

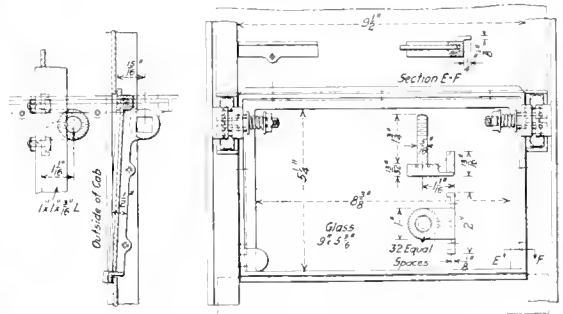

Clear Vision Windows for Steel Cab Doors

The frame bracket for the steel frame door is provided with a small lip on top which holds the glass in the cab door away from the frame, and the small glass in the frame is held in place by small wood strips and brass screws. Repairs can be made or the glass removed without removing the frame from the cab door.

This design has proven entirely satisfactory and has been adopted as standard by this road.



PORTABLE CRANK PIN PRESS

The Watson Stillman Company, New York, has developed a new type of portable press for forcing crank pins into locomotive and engine wheels and for miscellaneous shop and field forcing work. It contains some unusual features in its design and is intended to reduce the time and labor in doing this work.

In this press the hand pump is replaced by one driven by an air engine, the air being taken from the shop air main. The operating valves are so placed that the man in charge can operate the press in addition to directing the work of his men. The use of the air pump eliminates one man, the hand pump operator, from the crew, as well as increases the speed of doing the work approximately three hundred per cent.

The press is equipped with a gage, which accurately indicates pressure required to seat the pin. By this means it

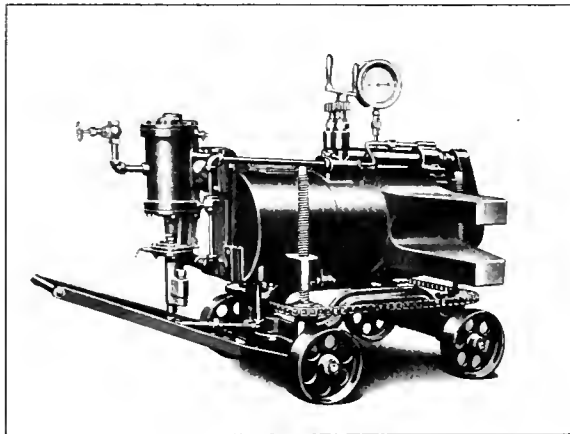

Portable Crank Pin Press of 300 Tons Capacity

is easy to detect a loose fit, which might seriously endanger the performance of a locomotive. The main portion of the press is an open hearth steel cylinder on the sides of which are cast heavy forks which support tie rods. The reservoir is mounted on the rear of the press and the ram operates from the front of the cylinder casting. The whole unit is carried on screws that are mounted on a truck. By turning any one of the screws the center line of the ram can be raised or lowered to meet the center line of the pin. Two tie rods and an abutment beam are used in connection with the press. The distance between the rods is adjustable in the forks so that the rods may be passed through spokes of the wheel at any convenient opening.

The ram is returned by a small hydraulic cylinder mounted on the top of the press, with its piston connected to a lug

on the end of the ram. All movements of the ram are controlled by a geared screw stem valve. These presses are built in capacities ranging up to 300 tons.

THE AMERICAN TRAINAGRAPH

An instrument for recording the performance of air brakes has been developed by the American Steam Gage & Valve Manufacturing Company, Boston, Mass. As shown in the illustration it is provided with three pens; the upper one records the pressure in the brake cylinder, the lower one at the left records the brake pipe pressure and the lower one at the right the auxiliary reservoir pressure. The pencil

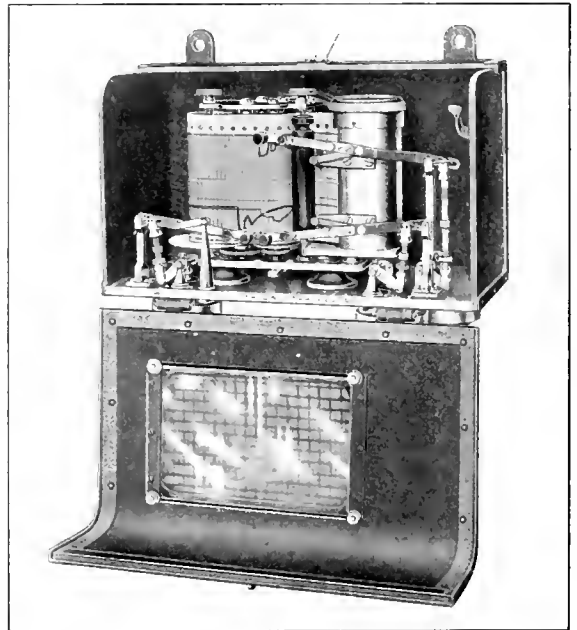

An Instrument for Giving Continuous Records of Brake Cylinder, Brake Pipe and Auxiliary Reservoir Pressures

motion is such that the pens move in a vertical which provides a record that may very easily be read.

The recording paper is divided horizontally into 5 lb. divisions and vertically in 5 second divisions. The movement of the paper is controlled by a powerful clock which can be started or stopped only when the cover of the recorder is opened as shown in the illustration. It can be locked and sealed in the closed position which makes it impossible for the record to be tampered with.

This instrument is particularly useful for testing air

brake equipment and has been designed to meet the particular needs of railway work. It is also of value for checking the performance of the engineman in the handling of a train. It can be placed on the locomotive as well as on cars. A set of 100 of these instruments are being used by the Automatic Straight Air Brake Company in the tests being made on that company's brake, a description of which is given elsewhere in this issue. Samples of charts taken with this instrument are illustrated in connection with that description.

These instruments will give continuous records 24 hours long with one setting which makes them particularly suited for long through service tests.

DRILLING MACHINE WITH TAPPING ATTACHMENT

The illustration shows a friction geared tapping attachment made by the Weigel Machine Tool Company, Peru, Ind., applied to its 25-in. vertical drilling machine. The tapping attachment is mounted directly on the spindle and has a reverse motion of 2 to 1 for the spindle. When tapping is done with the back gears thrown in, which is the usual practice, the spindle has a reverse motion of 12.88 to 1 by throwing the back gear lever onto direct drive.

The lever for operating the tapping attachment is placed in front on the left hand side of the machine close to the back gear lever so the operator can reach either or both

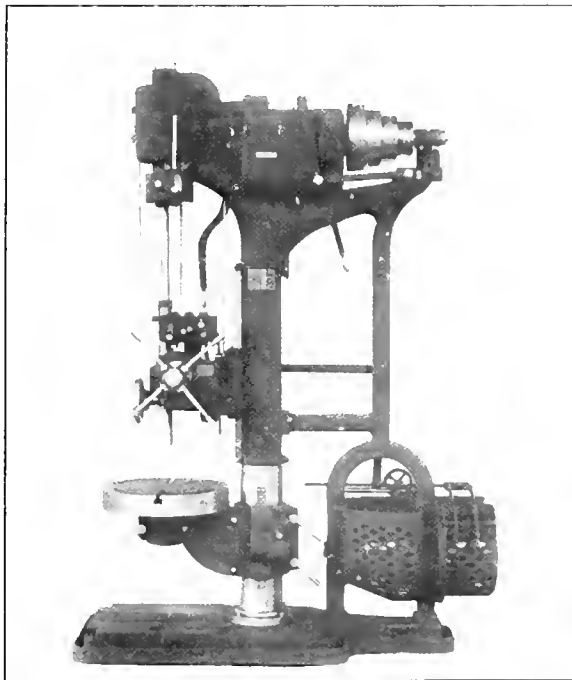

Weigel Drilling Machine with Tapping Attachment

levers without changing his position at the front of the machine. The driving key is made extra long and, having a good bearing on the spindle, prevents any cramping on either of the forward or reverse motion of the spindle. All gearing is entirely enclosed and the splash system of oiling is used. The tapping attachment can be disengaged when no tapping is to be done.

The base of the machine is stiff and well ribbed and has an oil pan extending entirely around the outer edge to keep oil from the floor. The table arm is stiff and is raised and

lowered by means of a rack and pinion actuated through a worm and worm gear. The bore for the hub of the table is made large enough to allow a compound table to be substituted at any time. Improved friction type back gears which are easily operated and positive in action are provided. Eight feeds are obtained for each spindle speed ranging from .0040 to .0432 to each revolution of the spindle. Changes are obtained by means of sliding gears operated by convenient levers and indicated by a plate attached to the machine.

An automatic stop which is positive in its action can be set to throw out the feed at any predetermined point. The friction quick return is powerful in action. The four operating levers are placed in the form of a pilot wheel any one of which engages or discharges the feed at will.

The principal dimensions of the machine are as follows:

Extreme height—spindle extended.....	9 ft. 9 1/2 in.
Traverse of head on column.....	21 in.
Traverse of spindle.....	11 in.
Diameter of table.....	22 in.
Diameter of column.....	7 1/2 in.
Diameter of spindle above sleeve.....	1 9/16 in.
Diameter of spindle in sleeve.....	1 11/16 in.
Diameter of sleeve.....	2 1/2 in.
Spindle tored—Morse taper.....	No. 4
Ratio bevel gears.....	2.5 to 1
Speed of tight and loose pulleys.....	500 r. p. m.
Spindle speeds—open belt.....	100, 160, 250, 400
Spindle speeds—back gear.....	15, 25, 39, 62

MOTOR HEADSTOCKS FOR WOODWORKING LATHES

Individual motor drive, now so widely used on machine tools, has been applied to small woodworking lathes by the Westinghouse Electric & Manufacturing Company, East Pittsburgh, Pa. This company is now manufacturing a line of motor headstocks for either alternating or direct current. Each equipment consists of a motor and controller especially designed for this service.

For alternating current circuits a special four-speed ball-bearing motor is furnished. The motor is totally enclosed by solid end brackets which exclude all dust and foreign substances. The feet are cast integral with the brackets to give maximum rigidity. The end thrust in either direction is taken by ball bearings. The end of the motor shaft nearest the tailstock is provided with an internal taper for a live center and a male thread for a face plate. The shaft extension on the opposite end is threaded to take a hand wheel. The controller, mounted in the leg of the lathe, gives motor speeds of approximately 570, 1,140, 1,725 and 3,450 r. p. m. at full load. Dynamic braking for slowing down is obtained by throwing the controller to the next lower speed.

For direct current circuits an adjustable speed, commutating pole, shunt wound motor, is furnished which gives speeds ranging from 600 to 3,000 r. p. m. by control of the field current. It is mounted in the same manner as the alternating current motor and resembles it in general construction. The controller for the direct current equipment is simple in construction. It is mounted in one leg of the lathe and is completely enclosed by a cover plate. Protection against low voltages and overload is afforded by relays which open the line circuit and stop the motor. The operator may stop his machine at any time by opening the main line switch, in which case dynamic braking automatically brings the motor to a quick stop.

The elimination of cone pulleys and belts makes it possible to place this motor in any location desired. It also assures better lighting and affords safety to the operator. It is claimed that the quality of the work is improved by the uniform speeds secured with motor headstocks. The operator can always use the exact speed desired and does not waste any time shifting belts. The construction and design of the equipment are such that occasional inspection and lubrication will keep the apparatus in good condition almost indefinitely and successful operation is assured even with hard usage and unskilled handling.

MOTOR DRIVE FOR RADIAL DRILLS

An interesting application of motors to radial drills has been made by the Cincinnati Bickford Tool Company, Oakley, Cincinnati, Ohio, where the variable speed direct connected motors are desired with the machine. The illustrations show two installations. In one case a 3 to 1 variable

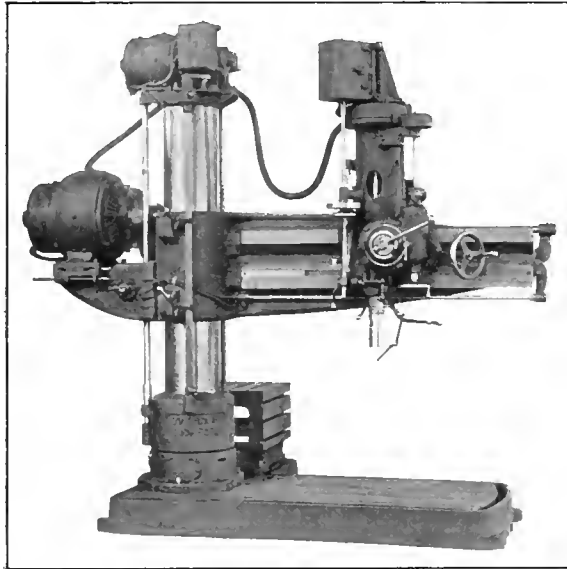

Application of Motors to the Arm and at the Top of the Column

speed motor is shown mounted on a bracket attached to the arm of the machine and on the opposite side of the column. The motor is geared directly to the arm shaft. The controller is mounted on the head of the machine. A constant speed reversing compound wound motor mounted on top of the column is used for elevating or lowering the arm. This

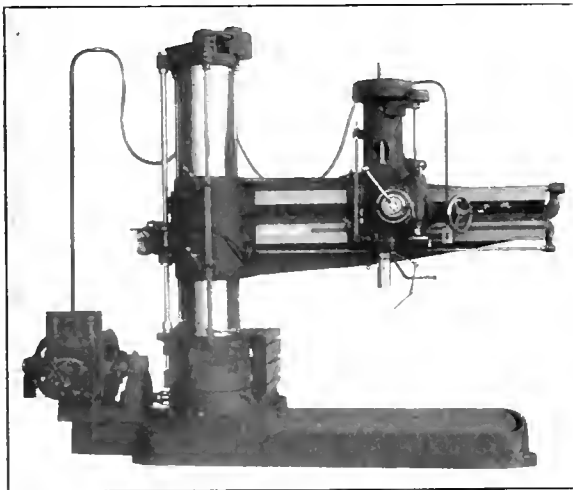

Motor Application at the Base of the Machine

motor is controlled by a reversing switch which is operated by a square shaft provided with that company's patented interlocking device.

The wires to this motor pass up on the inside of the column, a revolving connection being provided at the base of the

column for this purpose. This arrangement may be applied to the company's 4 ft., 5 ft. or 6 ft. radial drills.

The second illustration shows a Reliance adjustable speed motor mounted on the bed of the machine. A small motor for speed adjustment is attached to the larger motor. A remote push button control is used in this case, the push button being located on the head of the machine. As in the previous case this arrangement of motor drive may be applied to the 4 ft., 5 ft. and 6 ft. machines.

ABRASIVE BELT FINISHING MACHINE

The Blevney type B-6 polishing and finishing machine, which is shown in the illustration, has been placed on the market by the Blevney Machine Company, Greenfield, Mass. This machine is designed to do such work as it has been customary to handle on the ordinary set-up or buffing wheel, where the work is held to the wheel by hand.

The patented construction of the wheel and the use of a belt running over this wheel makes it possible to cut better and produce a superior finish to that which may be obtained on the ordinary solid wheel with an increase in production.

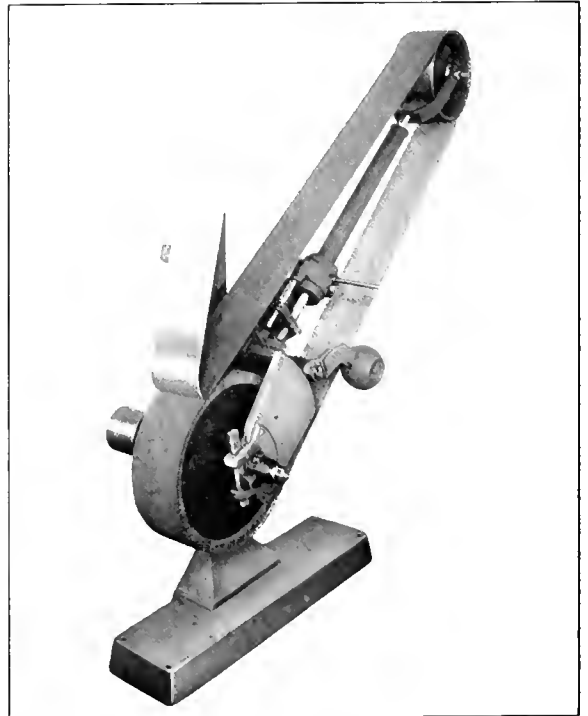

Blevney Type B-6 Polishing and Finishing Machine

The cost of abrasive is also reduced and the necessity of carrying a large stock of wheels is overcome.

The wheel is made up of a cast iron hub supporting two steel flanges into which are fitted approximately 225 leather blades attached to metal holding pieces which separate the leather sections from each other and also prevent radial bending of the leather under operating speed. The cloth abrasive belt passes over this wheel on one end of the machine and over a 12 in. idler pulley on the other end, this belt being the finishing member. The abrasive belt is automatically kept in tension by means of a weighted pressure operating through a rack and pinion arrangement directly on the spindle to which the idler pulley is attached. The tension pressure weight when lifted to its extreme position

will lock itself and become inoperative to facilitate the changing of the abrasive belt. A release is provided for this lock. Provision is made for instantly changing the lead of the belt over the cushion.

In operation the abrasive belt runs at the rate of 7,000 ft. per minute, and under this speed the tension of the belt will slightly bend or curve the leather blades. This bending is increased by the pressure of the work being finished causing the belt to be supported at the point of finishing by the corners of the leather blades, while immediately adjoining these supporting points and within the thickness of the blades the abrasive belt is unsupported; in fact, it curves in these places through the action of the pressure of the work, resulting in a receptacle for the chips generated and providing for the free passage of the chips. In other words, there is in effect saw teeth giving high points for cutting and low points for a chip recess, giving a quick and free cutting wheel with unnecessary friction eliminated. As the leather sections bend slightly from their usual position when in constant use, the wheel may be quickly taken off and reversed. In ordinary use, the wheel should be reversed about once weekly.

The wheel bearings are of an approved type lubricated by grease cups. The boxes are contained in the malleable iron section rigidly secured to the main cast iron wheel yoke and it is only necessary to drive out two wedges to remove the wheel and spindle complete. The frame holding the wheel and idler pulley with the other mechanism may be quickly raised or lowered on the column or may be tilted as may be best for the operation in hand.

In the operation of this machine an abrasive belt of suitable grit is used for roughing, a finer belt for the second cut and a dressed down or suitably charged belt for finishing, making three operations where the finish is of a high character. It is claimed that this machine will effect large savings and produce superior work.

AUTOMATIC STARTER FOR INDUCTION MOTORS

The need for an alternating current automatic motor starter has been clearly shown by the constant demand for something which would do for the squirrel cage motor what the automatic starter has done for the direct current motor. The Electric Controller & Manufacturing Company, Cleveland, Ohio, has recently made such a starter. The distinctive feature of it is that all of its parts, including the controlling coils, auto transformer coils and contact coils, are contained in a single case and are all submerged in oil. This device, which is called the E. C. & M. automatic compensator, can be installed by an electrician of ordinary ability and is operated by push buttons. This starter starts a squirrel cage motor in the usual way, in that the motor initially receives a reduced voltage through a transformer and after the attainment of considerable speed the reduced voltage is withdrawn and the line voltage is quickly applied to the motor.

The automatic starter is enclosed in an iron case, fitted at the top with a weather-proof iron cover. Eye bolts hold the cover in place and furnish means by which the starter may be transferred with a crane. A plugged oil hole is provided at the bottom of the case for draining the oil. The necessary leads to the starter emerge at the back, pointing downwards and are sealed hermetically tight where they pass through the case. In compliance with safety requirements the case has convenient means for connecting it to the ground. However, with the cover in place, all the exposed parts are dead, electrically. The compensator can be placed in small quarters with ample safety, or exposed to the severest weather without interference with its operation.

The main contacts are moved by a main control magnet, a relay known as a transition relay and a spring. This is accomplished by an interesting mechanical movement. A brief summary of the sequence of operations of this starter is as follows: First.—The operating magnet is excited, closing the armature, compressing a spring and connecting the motor to the source of supply through the transformer. Second.—After the motor has attained a suitable speed, the transition relay operates a latch, permitting the compression spring to disconnect the motor from the transformer and the transformer from the line, and to connect the motor to the line. Third.—When the operating magnet is de-energized, the armature falls open and the motor is disconnected from the supply lines. Any point on the movable contact completely bounds an enclosed area each time the compensator goes through one cycle of operation, passing progressively from "off" to "start," to "run," and finally again to the "off" position.

The compensator is submerged in oil with the exception



E. C. & M. Automatic Compensator for Alternating Current Motors

of the terminal board used for connecting the transformer voltage taps. The oil accomplishes several purposes; it cools and insulates all parts carrying current, it provides constant and liberal lubrication for the moving parts and it quickly quenches the arc which is formed when the contacts are separated. A special oil is used which has a high flash point, but which is still liquid enough at zero degrees, F., to allow free operation. On account of a large volume of oil and the freedom with which copper particles and carbon can settle harmlessly at the bottom it is not necessary to change the oil for at least five years of average service.

The arrangement of taps to the transformer coils is such that by means of the flexible leads it is possible to easily adjust the voltage for starting, that is, if the motor fails to start promptly under normal load conditions with the leads on certain taps, they may be changed to the next higher voltage. When the proper tap has been secured, the cover should be replaced and clamped in place.

The frame and operating mechanism is built in three standard sizes, covering a wide range of motors.

Railway Mechanical Engineer

(Formerly the RAILWAY AGE GAZETTE, MECHANICAL EDITION
with which the AMERICAN ENGINEER was incorporated)

PUBLISHED ON THE FIRST THURSDAY OF EVERY MONTH BY THE
SIMMONS-BOARDMAN PUBLISHING COMPANY

EDWARD A. SIMMONS, *President* L. B. SHERMAN, *Vice-President*
HENRY LEE, *Vice-President and Treasurer* M. H. WIUM, *Secretary*
WOOLWORTH BUILDING, NEW YORK, N. Y.
F. H. THOMSON, *Business Manager*, CHICAGO.

Chicago: Transportation Bldg. Cleveland: Citizens' Bldg.
Washington: Home Life Bldg.
London: Queen Anne's Chambers, Westminster.

ROY V. WRIGHT, *Editor*
R. E. THAYER, *Managing Editor*
C. B. PECK, *Associate Editor* A. F. STUBING, *Associate Editor*

Entered at the Post Office at New York, N. Y., as mail matter of the second class.

Subscriptions, including the eight daily editions of the *Railway Age Gazette* published in June in connection with the annual conventions of the Master Car Builders' and American Railway Master Mechanics' Associations, payable in advance and postage free: United States, Canada and Mexico, \$2.00 a year; Foreign Countries (excepting daily editions), \$3.00 a year; Single Copy, 20 cents.

WE GUARANTEE that of this issue 9,000 copies were printed; that of these 9,000 copies 7,812 were mailed to regular paid subscribers, 113 were provided for counter and news companies' sales, 314 were mailed to advertisers, 218 were mailed to exchanges and correspondents, and 543 were provided for new subscriptions, samples, copies lost in the mail and office use; that the total copies printed this year to date were 101,347, an average of 9,113 copies a month.

THE RAILWAY MECHANICAL ENGINEER is a member of the Associated Business Papers (A. B. P.) and the Audit Bureau of Circulations (A. B. C.).

In the Federal Court at Louisville, Ky., the Louisville & Nashville has been fined \$200 for violation of the Safety Appliance Act.

In the shops of the Grand Trunk at Stratford, Ont., the female employees have been directed to wear overalls and caps. This is to lessen the danger of accident by catching clothing in machinery.

The Delaware & Hudson is about to reopen its car shops at Green Island, N. Y., near Troy, which have been idle for seven years. The company is now trying to get the 100 men needed to organize a force to repair freight cars at those shops.

The machine shop and roundhouse of the Chicago & Eastern Illinois at Salem, Ill., were destroyed by fire on the morning of October 25. The explosion of a five gallon can of gasoline is believed to have started the fire and the loss is estimated at \$200,000.

The New York Central has temporarily suspended the rule under which all employees reaching the age of 70 years are to be retired on pension, and those not physically unfit will be retained in the service. Former employees, now retired on pension, who are physically able and competent to perform some work, will be re-employed temporarily, if they so desire.

The recruiting sergeant at Altoona, Pa., recently received a message from the War Department, reading as follows:

"Five hundred car builders or car repairmen for work in French railway shops, must be recruited in your district at once. They will be rated from \$33 to \$106 a month." With the message came the information that the men would be assigned to the 35th Engineers of the National Army.

The Alabama Supreme Court holds that the Alabama locomotive headlight law of 1915 has no application to engines engaged in interstate commerce, the federal act of 1911 as amended in March, 1915, having excluded the states from the right to legislate, though the final federal rules on the subject of headlights were not promulgated until after a railroad charged with violating the Alabama law committed the offense.

The Chicago, Milwaukee & St. Paul has announced that the contract for locomotives and substation equipment for its Cascade Mountain electrification from Othello, Wash., to Tacoma and Seattle has been divided between the General Electric Company and the Westinghouse Electric & Manu-

facturing Company. The section to be electrified is 211 miles long; this, with the 440 miles already electrically operated, will make a total of 651 miles.

Judge Anderson of the United States district court for the district of Indiana, at Indianapolis on October 9 dismissed a complaint of the New York Central against the enforcement of the Interstate Commerce Commission's order requiring the use of high power locomotive headlights. The complaint was dismissed, at the cost of the complainant, on motion of Blackburn Esterline, special assistant to the attorney general, not on the merits of the headlight order but on technicalities regarding the form of the complaint.

The campaign for early shipment of Christmas packages, already started in a number of places, is being pushed jointly by the American Railway Association's car service committees of Chicago, Milwaukee, Wis., and South Bend, Ind. Co-operation is promised by representatives of the National Industrial Traffic League and the Chicago Association of Commerce. Each railroad is to do everything possible to promote early shipments, whether by mail or express. Among prospective recipients are approximately a million soldiers in the various cantonments and training camps. The post-office department has fixed November 15 as the last day for mailing Christmas packages to our soldiers and sailors abroad.

A decision was rendered by the Federal District Court, S. D., Florida, in favor of the government in an action for the penalty for keeping trainmen on duty more than 16 hours. The railroad company claimed that the violation of the 16-hour law was necessary due to the derailment of cars and the impossibility of clearing the track before the time limit was up, the accident occurring at a place where it was impracticable to substitute another crew. The court sustained the government because the railroad was silent as to the cause of the derailment, the court holding that if the derailment could have been avoided by ordinary oversight, the accident could not have been said to be unavoidable, and unless it was unavoidable the railroad had no defense.

Alfred H. Smith, president of the New York Central Lines, has issued a statement showing the immense expenditures of those roads for cars and locomotives during the three years and two months since the war began. The total for locomotives, freight cars and passenger coaches is \$84,324,736; and this equipment at the prices prevailing today would

cost \$193,028,610, or an increase of 128.91 per cent. Of freight cars the New York Central bought in the three years 38,052 for the sum of \$53,762,036, or an average of \$1,412.85 per car. The same cars today would cost \$133,839,810, an average of \$3,519.92 per car. The companies bought 734 engines for \$23,768,500, or an average of \$32,383.15 per locomotive. The same locomotives would cost today \$46,927,000, an average of \$63,933.51 each. Passenger coaches bought numbered 445, costing \$6,794,200, an average of \$15,267.87 per coach. The same cars would now cost \$12,261,600, an average of \$27,544.16.

Three members of the American Railroad Commission which went to Russia early in the year to study the railway conditions of that country, with a view to extending assistance from this country, have returned to the United States with detailed recommendations in addition to the reports which have been sent by letter and by cable. Those who have returned are W. L. Darling, formerly chief engineer of the Northern Pacific; George Gibbs, consulting electrical engineer; and J. E. Greiner, formerly chief consulting engineer of the Baltimore & Ohio. They have reported a considerable improvement in the congestion at Vladivostok which has hampered the transportation of supplies over the Trans-Siberian Railway. Extensive plans for improving the condition of the road are now under way at Washington and elsewhere, under the direction of S. M. Felton, director-general of railways, for the War Department. Twelve units of railway officers, consisting of division superintendents and their staffs, and including a considerable number of shop men, are being recruited to be sent to Russia. They will be under the direction of G. H. Emerson, general manager of the Great Northern.

Preliminary Locomotive Design

On page 555 of the October issue of the *Railway Mechanical Engineer* a method for calculating the sectional area of locomotive frames was given. An error was made in the number of decimal places for the constants and the table should read as follows:

	O. H. steel	Vanadium
Top of pedestal.....	T N .00038	T N .00035
Top rail between pedestals.....	T N .00033	T N .00030
Lower rail between pedestals.....	T N .00022	T N .00020

Employment of Women in Shops

Railroads in the Middle West are gradually adding more women to their pay rolls to take the places of employees who have left to serve their country. The Northern Pacific recently employed four women for clerical work in the local freight office, eight in the yard office and one in the mechanical department at Duluth, Minn. In addition, the road already had at work six women in the roundhouse in that city, one in a clerical position in the car shops and 14 at manual labor. The women employed for manual labor in the mechanical department are largely engaged in wiping engines and cleaning up around the cinder pits, while of those in the car shops, one works at a bench repairing air apparatus and 13 are in the yard unloading grain-door lumber.

The Chicago, Burlington & Quincy has employed 12 women at its St. Joseph (Mo.) shops to clean up rubbish on repair tracks, sweep shop buildings and wipe locomotives. The Grand Trunk recently employed a woman ticket agent in its Chicago city office, and the Chicago & North Western a station mistress at Ames, Iowa.

Two prominent roads in the East have women at work in track-repair gangs.

Railroad Companies Subscribed for \$77,810,000 of the Liberty Loan

The railroads in addition to making strong efforts to secure subscriptions to the second issue of the Liberty Loan among their employees and assisting them in paying for these bonds on a partial payment plan, themselves subscribed for \$77,810,000 of the Liberty bonds. They also advertised them extensively to their patrons. The following list gives the amount subscribed by the railroads on record:

Atchison, Topeka & Santa Fe.....	\$7,000,000
Atlanta & West Point.....	300,000
Chesapeake & Ohio.....	500,000
Chicago & North Western.....	3,500,000
Chicago, Burlington & Quincy.....	5,000,000
Chicago, Milwaukee & St. Paul.....	2,500,000
Delaware & Hudson.....	1,000,000
Delaware, Lackawanna & Western.....	5,000,000
Illinois Central.....	1,000,000
Kansas City Southern.....	500,000
Lehigh Valley.....	1,500,000
Long Island.....	500,000
Louisville & Nashville.....	6,000,000
Missouri Pacific.....	1,000,000
Mobile & Ohio.....	420,000
Nashville, Chattanooga & St. Louis.....	250,000
Norfolk & Western.....	5,000,000
Northern Pacific.....	10,000,000
Panama.....	30,000
Pennsylvania.....	10,000,000
Pittsburgh & West Virginia.....	250,000
St. Louis San Francisco.....	300,000
St. Louis Southwestern.....	750,000
Southern Pacific.....	5,000,000
Texas & Orleans.....	10,000
Union Pacific.....	10,000,000
Virginian.....	500,000

Besides the subscriptions of the companies, the Railroads' War Board estimates that the railroad employees of this country have taken more than \$50,000,000 worth of the Second Liberty bond issue. For the first bond issue 241,280 railroad employees subscribed an aggregate of \$20,027,966.

MEETINGS AND CONVENTIONS

Richmond Railroad Club.—The Richmond Railroad Club has decided to suspend all meetings and activities during the war.

Car Foremen's Association of Chicago.—At the annual meeting of the Car Foremen's Association of Chicago, which was held at the Hotel Morrison, Chicago, on October 8, the following officers were elected: President, H. H. Estrup, general foreman, Chicago & Eastern Illinois; first vice-president, E. G. Chenoweth, mechanical engineer, Rock Island Lines; second vice-president, M. F. Covert, assistant master car builder, Swift & Co.; treasurer, F. C. Schultz, chief interchange inspector, Chicago Car Interchange Bureau; Aaron Kline. The association voted to invest \$500 of its funds in five \$100 Liberty Bonds of the second series.

Association of Manufacturers of Chilled Car Wheels.—The annual meeting of the Association of Manufacturers of

RAILROAD CLUB MEETINGS

Club	Next Meeting	Title of Paper	Author	Secretary	Address
Canadian.....	Nov. 13, 1917	Draft Gains.....	Prof. Louis Endsley.	James Fowell....	P. O. Box 7, St. Lambert, Que.
Central.....	Nov. 9, 1917	Conservation.....	J. P. Murphy.....	Harry D. Vought	95 Liberty St., New York.
Cincinnati.....	Nov. 13, 1917	Annual Meeting, Election of Officers, Banquet and After Dinner Talk by.....	Ex-Gov. Jud. Harmon	H. Bouret.....	101 Carew Bldg., Cincinnati, O.
New England....	Nov. 13, 1917	Ordering, Distribution and Use of Supplies	Geo. G. Yeomans....	W. E. Cade, Jr....	683 Atlantic Ave., Boston, Mass.
New York.....	Nov. 16, 1917	The Woman in Railroad Work.....	Stuart Prady.....	Harry D. Vought	95 Liberty St., New York.
Pittsburgh.....	Nov. 23, 1917	The Problems of the American Republic....	Rev. S. McC. Lindsay	J. B. Anderson....	207 Penn. Station, Pittsburgh, Pa.
St. Louis.....	Nov. 9, 1917	(Subject Not Announced).....	E. F. Kearney.....	R. W. Frauenthal	Union Station, St. Louis, Mo.
South'n & S'w'm.	Nov. 15, 1917			A. J. Merrill.....	Grand Building, Atlanta, Ga.
Western.....	Nov. 19, 1917	Fuel Economy.....		J. W. Taylor.....	1112 Karpen Building, Chicago.

Chilled Car Wheels was held at the Waldorf-Astoria Hotel, New York, October 9. George W. Lyndon, president of the association, in his opening address called attention to the carrying capacity of the chilled iron wheel, saying in part as follows:

"It is now a well established fact that the load that can be carried on a chilled iron wheel is only measured by the ability of the rail to support it. Many 33-in., 950-lb. chilled iron wheels are running under heavy locomotive tenders of 12,000 gal. capacity, and are giving such a good account of themselves that no other type of wheel is considered by the users.

"We must pay the closest attention to the quality of our product. We must see that the interior of the 625-lb. and 725-lb. wheel receives recognition in the matter of increased plate thicknesses which can only be obtained by additional weight. We must have a reasonable factor of safety when measured by excessive stresses encountered in service, and these heat stresses are now recognized everywhere due to our educational campaign. We are not influenced by commercial consideration in asking for heavier wheels. We know the increased weights are necessary."

The following officers were elected for the ensuing year: George W. Lyndon, president and treasurer; E. F. Carry and J. A. Kilpatrick, vice-presidents; George F. Griffin, secretary, and F. K. Vial, consulting engineer. The following compose the board of directors: J. M. Buick, vice-president, American Car and Foundry Company; J. A. Kilpatrick, president, Albany Car Wheel Company; W. S. Atwood, chief engineer, Canadian Car & Foundry Company; Charles A. Lindstrom, assistant to president, Central Car Wheel Company; F. K. Vial, chief engineer, Griffin Wheel Company; E. F. Carry, president Haskell & Barker Car Company; A. G. Wellington, president, Maryland Car Wheel Works; W. C. Arthurs, president, Mt. Vernon Car Manufacturing Company; J. D. Rhodes, president, National Car Wheel Company; F. B. Cooley, president, New York Car Wheel Company; A. J. Miller, general manager, Ramapo Foundry & Wheel Works, and William F. Cutler, vice-president, Southern Wheel Company.

The following list gives names of secretaries, dates of next or regular meetings and places of meeting of mechanical associations:

- AIR BRAKE ASSOCIATION.—F. M. Nellis, Room 3014, 165 Broadway, New York City.
- AMERICAN RAILROAD MASTER TINNERS', COPPERSMITHS' AND PIPEFITTERS' ASSOCIATION.—O. E. Schlink, 485 W. Fifth St., Peru, Ind. Convention postponed.
- AMERICAN RAILWAY MASTER MECHANICS' ASSOCIATION.—J. W. Taylor, Karpen Bldg., Chicago. Convention postponed.
- AMERICAN RAILWAY TOOL FOREMEN'S ASSOCIATION.—R. D. Fletcher, Belt Railway, Chicago. Convention postponed.
- AMERICAN SOCIETY FOR TESTING MATERIALS.—Prof. E. Marburg, University of Pennsylvania, Philadelphia, Pa.
- AMERICAN SOCIETY OF MECHANICAL ENGINEERS.—Calvin W. Rice, 29 W. Thirty-ninth St., New York.
- ASSOCIATION OF RAILWAY ELECTRICAL ENGINEERS.—Joseph A. Andreuccetti, C. & N. W., Room 411, C. & N. W. Station, Chicago.
- CAR FOREMEN'S ASSOCIATION OF CHICAGO.—Aron Kline, 841 Lawlor Ave., Chicago. Second Monday in month, except June, July and August, Hotel Morrison, Chicago.
- CHIEF INTERCHANGE CAR INSPECTORS' AND CAR FOREMEN'S ASSOCIATION.—W. R. McMunn, New York Central, Albany, N. Y. Convention postponed.
- INTERNATIONAL RAILROAD MASTER BLACKSMITHS' ASSOCIATION.—A. L. Woodworth, C. H. & D., Lima, Ohio. Convention postponed.
- INTERNATIONAL RAILWAY FUEL ASSOCIATION.—J. G. Crawford, 547 W. Jackson Blvd., Chicago.
- INTERNATIONAL RAILWAY GENERAL FOREMEN'S ASSOCIATION.—William Hall, 1126 W. Broadway, Winona, Minn. Convention postponed.
- MASTER BOILERMAKERS' ASSOCIATION.—Harry D. Vought, 95 Liberty St., New York. Convention postponed.
- MASTER CAR BUILDERS' ASSOCIATION.—J. W. Taylor, Karpen Bldg., Chicago. Convention postponed.
- MASTER CAR AND LOCOMOTIVE PAINTERS' ASSOCIATION OF U. S. AND CANADA.—A. P. Dane, P. & M., Reading, Mass. Convention postponed.
- NIAGARA FRONTIER CAR MEN'S ASSOCIATION.—E. N. Frankenberger, 623 Brisbane Bldg., Buffalo, N. Y. Meetings, third Wednesday in month, New York Telephone Bldg., Buffalo, N. Y.
- RAILWAY STOREKEEPERS' ASSOCIATION.—J. P. Murphy, Box C, Collinwood, Ohio. Convention postponed.
- TRAVELING ENGINEERS' ASSOCIATION.—W. O. Thompson, N. Y. C. R. R., Cleveland, Ohio. Next meeting, September 10, 1918, Chicago.

PERSONAL MENTION

GENERAL

W. J. BENNETT, assistant superintendent of motive power of the Denver & Rio Grande, at Denver, Colo., has been appointed superintendent of the motive power and car departments, with the same headquarters, succeeding J. F. Enright, deceased.

T. B. BURGESS, assistant division superintendent of the Baltimore & Ohio at Cleveland, Ohio, has been appointed supervisor of locomotive operation of the West Virginia district, with headquarters at Wheeling, W. Va., succeeding T. K. Faherty, transferred.

B. F. CROLLEY, supervisor of locomotive operation of the Baltimore & Ohio, with headquarters at Cincinnati, Ohio, has been relieved of jurisdiction over the Southwest district, and is now supervisor of locomotive operation of the North-west district, with headquarters at the same place.

HENRY C. EICH, whose appointment as superintendent of motive power of the Chicago Great Western, with headquarters at Oelwein, Ia., was announced in the *Railway Mechanical Engineer*



H. C. Eich

for October, was born in Chicago. On January 2, 1883, he entered railway service as an office boy in the general offices of the Illinois Central at Chicago and subsequently became machinist apprentice in the Weldon shops, Chicago. He was then successively machinist in the Weldon shops, locomotive fireman at the Burnside shops, general and roundhouse foreman at Freeport, Ill., division general foreman at Louisville,

Ky., and master mechanic at East St. Louis, Ill., Memphis, Tenn., and at the Burnside shops in Chicago. He held the latter position until his appointment as superintendent of motive power of the Chicago Great Western on October 1.

A. C. DEVERELL, superintendent of motive power of the Great Northern, with headquarters at St. Paul, Minn., has been given entire jurisdiction over the mechanical department.

E. B. DE VILBISS, assistant engineer of motive power of the Pennsylvania Lines West at Toledo, Ohio, has been transferred to the general office at Pittsburgh, Pa., succeeding O. C. Wright.

R. D. HAWKINS, superintendent of motive power of the Great Northern at St. Paul, Minn., with jurisdiction over part of the mechanical department, has been granted an indefinite leave of absence to enter the Russian Railway Service Corps.

SAMUEL J. HUNGERFORD, superintendent rolling stock of the Canadian Northern, has been appointed general manager of the Eastern lines, with office at Toronto, Ont., vice L. C. Fritch resigned.

F. HODAPP, road foreman of engines on the Illinois division of the Baltimore & Ohio, at Flora, Ill., has been ap-

pointed supervisor of locomotive operation of the Southwest district, with headquarters at Cincinnati, Ohio.

J. R. JACKSON, assistant engineer of tests on the Atchison, Topeka & Santa Fe at Chicago, has received a commission as captain of ordnance in the Officers' Reserve Corps, but has not yet been assigned to active duty.

CLAUDE M. STARKE, master mechanic of the Illinois Central at McComb, Miss., has been appointed assistant superintendent of motive power of the Missouri, Kansas &



C. M. Starke

pointed master mechanic at Water Valley on June 1, 1912, and one year later was transferred to McComb. He held the latter position until October 1, 1917, when he received his appointment as assistant superintendent of motive power of the Missouri, Kansas & Texas.

WILLIAM KELLY, assistant superintendent of motive power of the Great Northern at Spokane, Wash., has been transferred to St. Paul, Minn.

JOHN M. HENRY, assistant superintendent of the New York division of the Pennsylvania Railroad at Jersey City, N. J., has been appointed assistant



J. M. Henry

loughed from the shops during the school term each year. In June, 1900, he became a special apprentice in the office of the assistant engineer of motive power at Altoona; on July 1, 1901, he was promoted to motive power inspector at Altoona, and in February, 1902, was made assistant engineer of motive power of the Erie division and Northern Central Railway at Williamsport, Pa. He was promoted

Texas, with headquarters at Parsons, Kan. Mr. Starke was born at Water Valley, Miss., on January 15, 1878, and entered the service of the Illinois Central on April 9, 1891, as a clerk at Water Valley. He was subsequently machinist apprentice, machinist and round-house foreman, and was promoted to general foreman at Indianapolis, Ind., on April 1, 1909, being transferred to Campaign, Ill., in a similar capacity on September 1, 1911. He was ap-

pointed general superintendent of motive power of the lines east of Pittsburgh with headquarters at Altoona, Pa. He was born on October 10, 1873, and was educated in the public schools of Altoona and graduated from Purdue University in June, 1900. He entered the service of the Pennsylvania Railroad as a special apprentice in the Altoona machine shops on May 5, 1889. He served as an apprentice until September 1, 1896, when he entered Purdue University, being fur-

to master mechanic of the Elmira, N. Y., shops on July 1, 1903, and later served in the same capacity first at the Sunbury shops and then at the Olean shops and at the West Philadelphia shops. On December 1, 1913, he was promoted to superintendent of motive power of the Western Pennsylvania division, at Pittsburgh, Pa., and on May 1, 1916, was appointed assistant superintendent of the Pittsburgh division. He was transferred as assistant superintendent to the New York division on April 15, 1917, and now becomes assistant general superintendent of motive power at Altoona, as above noted.

W. M. KELLY, acting general foreman of the erecting shops of the Pennsylvania Railroad at Altoona, Pa., has been promoted to resident inspector in the Philadelphia district. His new duties will consist of following up the performance of trial devices for locomotives.

CHARLES MANLEY has been appointed superintendent of machinery of the Missouri & North Arkansas, with jurisdiction over all mechanical and car departments with office at Harrison, Ark., and the position of superintendent, formerly held by him, has been abolished.

L. S. KINNAIRD, whose appointment as superintendent of motive power of the Chicago & Eastern Illinois, with headquarters at Danville, Ill., was announced in the October



L. S. Kinnaird

Railway Mechanical Engineer, was born on July 23, 1869, at Ft. Wayne, Ind., and graduated in mechanical engineering from Purdue University in 1896. He began railway work in 1890 as a draftsman for the Pennsylvania company, serving in that capacity until September, 1892, when he entered Purdue. He worked as a special apprentice in the shops of the Pennsylvania Company during the summers of 1893, 1894 and 1895, and on July 5, 1896, took permanent employment with that company as a special apprentice. On January 1, 1900, he was appointed assistant master mechanic at Allegheny, Pa., and on November 20, 1902, he was appointed master mechanic of the Cleveland, Akron & Columbus at Mt. Vernon, Ohio. Mr. Kinnaird was appointed master mechanic of the Pittsburgh, Cincinnati, Chicago & St. Louis, at Logansport, Ind., on June 1, 1915, which position he resigned on September 30 to become superintendent of motive power of the Chicago & Eastern Illinois.

H. A. MACBETH, division master mechanic of the New York, Chicago & St. Louis, at Conneaut, Ohio, has been appointed assistant superintendent of motive power, with headquarters at Cleveland, Ohio.

HENRY YOERG, mechanical engineer of the Great Northern at St. Paul, Minn., has been appointed assistant superintendent of motive power with headquarters at St. Paul, Minn.

A. J. WITCHELL, engineer of tests of the Spokane, Portland & Seattle, has been appointed to the newly created position of assistant to the general superintendent, with office at Portland, Ore.

W. R. WOOD, mechanical valuation engineer of the Great Northern at St. Paul, Minn., has been appointed to suc-

ceed Henry Yoerg as mechanical engineer, with headquarters at the same place.

MASTER MECHANICS AND ROAD FOREMEN OF ENGINES

R. J. CLARK master mechanic of the Great Northern at Spokane, Wash., has been promoted to general master mechanic of the Western district, with the same headquarters, succeeding William Kelly.

T. W. COE, master mechanic of the Indiana Harbor Belt, at Gibson, Ind., has been appointed master mechanic of the New York, Chicago & St. Louis, at Conneaut, Ohio, succeeding H. A. Macbeth.

C. H. CREAGER, road foreman of engines of the Baltimore & Ohio, at Cincinnati, Ohio, has been appointed road foreman of engines of the Illinois division, with headquarters at Flora, Ill. succeeding F. Hodapp, promoted.

J. J. DOWLING, master mechanic of the Great Northern at Delta, Wash., has been appointed general master mechanic of the central district, with office at Great Falls, Mont., succeeding M. J. Flanigan, promoted.

CHARLES O. KEAGY, general foreman of the West Philadelphia shops of the Pennsylvania Railroad, has been appointed master mechanic of the Middle division of the main line, with office at Altoona, Pa.

Mr. Keagy was born at Woodbury, N. J., on February 15, 1877. He was educated in the public schools and on August 27, 1894, he entered the service of the Pennsylvania Railroad as an apprentice in the Altoona shops. He filled various positions there, until January 1, 1902, when he was appointed an inspector in the motive power department. Mr. Keagy was advanced to assistant chief car inspector on January 1, 1904, and on October 1, 1905, he was made general foreman of passenger car inspectors. He was appointed general car inspector on May 1, 1906, and on April 15, 1907, he was transferred to the West Philadelphia shops as general foreman. He held that position until October 10, 1917, when he was made master mechanic of the middle division, with office at Altoona as mentioned above.

M. J. FLANIGAN, general master mechanic of the Central district of the Great Northern, at Great Falls, Mont., has been promoted to superintendent at Whitefish, Mont.

J. G. KIRCHER has been appointed road foreman of engines of the Ohio River division of the Baltimore & Ohio, with headquarters at Parkersburg, W. Va., succeeding E. J. Langhurst, transferred.

EDWARD LAWLESS, general foreman locomotive department of the Illinois Central at Freeport, Ill., has been promoted to master mechanic with the same headquarters, succeeding V. U. Powell, transferred.

CHARLES LEE McILVAINE, master mechanic of the Philadelphia division of the Pennsylvania Railroad at Harrisburg, Pa., has been appointed superintendent of motive power of the Northern division, with headquarters at Buffalo, N. Y. Mr. McIlvaine's photograph and a sketch of his career were

published in the *Railway Mechanical Engineer* for June, 1917, p. 363.

M. B. McPARLAND has been appointed master mechanic of the Denver & Salt Lake, with jurisdiction over the motive power and car departments, with headquarters at Utah Junction, Denver, Colo.

E. W. SMITH, assistant engineer of motive power of the Pennsylvania Railroad at Altoona, Pa., has been appointed master mechanic of the Philadelphia division, with office at Harrisburg, Pa., succeeding C. L. McIlvaine. Mr. Smith was born at Charlesburg, W. Va., on September 21, 1885. He is a graduate of the Virginia Polytechnic Institute and he entered the service of the Pennsylvania Railroad on August 1, 1906, as a special apprentice. On July 26, 1909, he was made motive power inspector, was advanced to motive power foreman on September 1, 1912, and on October 15, 1913, he was appointed assistant master mechanic at the Altoona machine shops. On July 1, 1916, he was advanced to assistant engineer of motive power in the office of the general superintendent of motive power at Altoona, and on October 10, 1917, he received his appointment as mechanic of the Philadelphia division.

J. M. MENDELL has been appointed road foreman of engines of the Cincinnati Terminal division of the Baltimore & Ohio with headquarters at Cincinnati, Ohio, succeeding C. H. Creager, transferred.

O. C. WRIGHT, assistant engineer of motive power of the Pennsylvania Lines West, at Pittsburgh, Pa., has been appointed master mechanic on the Southwest system at Logansport, Ind. Mr. Wright was born on June 20, 1883, at Marion, Ind. He was educated in the public and high school of Marion, and was graduated from Purdue University in the summer of 1905. During his summer vacations he worked in the maintenance of way department of the Pennsylvania Lines West, from June, 1902, until his graduation. He became a special apprentice in the Columbus, Ohio, shops in June, 1905, and in September of the same year was transferred to the Ft. Wayne shops, where he finished his apprenticeship. He was then made assistant night enginehouse foreman at Ft. Wayne, following which he was an electrical engineer, then assistant engineer of motive power at Ft. Wayne. On January 1, 1917, he was made assistant engineer of motive power in the office of the



E. W. Smith



C. O. Keagy



O. C. Wright

general superintendent of motive power, at Pittsburgh, and on October 1, 1917, he was promoted to master mechanic at the Logansport, Ind., shops.

H. P. MEREDITH, master mechanic of the Maryland and Delaware divisions of the Philadelphia, Baltimore & Washington, at Wilmington, Del., has resigned to go into other business.

T. M. PRICE, assistant master mechanic of the Seaboard Air Line at Andrews, S. C., has been appointed master mechanic at Hamlet, N. C., succeeding T. L. Reed.

E. C. RODDIE, district foreman of the Illinois Central at New Orleans, La., has been promoted to the position of master mechanic at McComb, Miss., to succeed C. M. Starke resigned.

O. B. SCHOENKY, superintendent of shops of the Southern Pacific at Los Angeles, Cal., has been appointed master mechanic of the Tucson division, with office at Tucson, Ariz., succeeding W. C. Peterson, transferred.

F. W. SCHULTZ has been appointed master mechanic of the Kansas City, Mexico & Orient of Texas at San Angelo, Texas, succeeding T. C. Kyle.

M. K. WALSH has been appointed road foreman of engines of the Wheeling division of the Baltimore & Ohio, with headquarters at Benwood Junction, W. Va., succeeding W. F. Ross, deceased.

SHOP AND ENGINEHOUSE

WILLIAM F. BLACK, acting erecting shop foreman of the New York Central at Avis, Pa., has been permanently appointed to this position. He was born in 1883 and was educated in the common and high schools of Oswego, N. Y. His first experience in railroad work was in 1901 as an apprentice at the Oswego shops of the New York Central. In 1909 he was appointed apprentice instructor and assistant machine foreman there and in 1911 was promoted to the position of apprentice class instructor. In March, 1914, he was transferred to Avis, Pa., as chief draftsman and apprentice instructor and received his appointment as erecting shop foreman on September 21, 1917.

E. H. NEWBURY, assistant master mechanic of the Monongahela division of the Pennsylvania Railroad at South Pittsburgh, Pa., has been appointed shop inspector in the office of the superintendent of motive power at Pittsburgh, Pa.

H. R. VOELKER, foreman in the shops of the Pennsylvania Lines West at Bradford, Ohio, has been promoted to general foreman in the shops at Louisville, Ky.

SAMUEL VOGEL, enginehouse foreman of the Pittsburgh, Cincinnati, Chicago & St. Louis, has been pensioned after 42 years of service for the Pittsburgh division. Mr. Vogel was born on July 13, 1852, at Tuscarawas, Ohio, and entered the service of the Pan Handle on March 2, 1875, as a laborer in the shops at Dennison, Ohio, later serving as apprentice, machinist and gang foreman. He was promoted to enginehouse foreman at Dennison on September 1, 1890, and was transferred to Pittsburgh on December 1, 1891, as enginehouse foreman, later to Sheridan, Pa., and then to the Scully enginehouse, where he was in charge at the time of his retirement.

PURCHASING AND STOREKEEPING

H. A. ANDERSON, special agent in the purchasing department of the Pennsylvania Railroad at Philadelphia, Pa., has been promoted to assistant purchasing agent with headquarters at Philadelphia. He entered the service of the Pennsylvania Railroad in July, 1883, as a messenger in the transportation department at Altoona, Pa. Three years later he was transferred to the motive power department

where he served as clerk in the Juniata shops, and later as chief clerk to the general superintendent of motive power. In February, 1904, he was promoted to stock clerk in the purchasing department, and in December of the following year was made special agent of the purchasing department, which position he held at the time of his recent appointment as assistant purchasing agent.

JOHN E. BYRON, whose appointment as general storekeeper of the Boston & Maine with headquarters at Boston, Mass., has already been announced in these columns, was born on December 4, 1874, at Concord, N. H., and received his education in grammar, high school and business college. He began railway work on April 25, 1892, as clerk and stenographer to the general manager of the Concord & Montreal, and on July 22, 1895, became superintendent's clerk on the Southern division of its successor, the Boston & Maine. In November, 1911, he was appointed chief clerk in the maintenance of way department and in August, 1917, was appointed general storekeeper of the same road, as above noted.

A. L. COCHRANE, general storekeeper of the Denver & Salt Lake at Denver, Colo., has been appointed purchasing agent and storekeeper succeeding C. N. Davids, resigned.

J. F. ESCH has been appointed purchasing agent of the Colorado Midland, with headquarters at Colorado Springs, Colo., in place of C. N. Davids, resigned.

D. T. JONES, stationer of the Pennsylvania Railroad at Philadelphia, Pa., has been promoted to assistant to purchasing agent.

B. P. PHILIPPE, coal agent in the purchasing department of the Pennsylvania Railroad at Philadelphia, Pa., has been promoted to assistant to purchasing agent.

ROBERT E. SCOTT, assistant roadmaster of the Oregon Electric, has been appointed purchasing agent of the Spokane, Portland & Seattle, with headquarters at Portland, Ore.

NEW SHOPS

CHICAGO GREAT WESTERN.—A contract has been awarded by this road to T. S. Leake & Co., Chicago, for the construction of an 11-stall roundhouse at Clarion, Iowa. The structure will replace a 14-stall building, which was destroyed by fire last April.

PHILADELPHIA & READING.—This company is building a 15-stall, one-story enginehouse at Reading, Pa., on a site located north of the shops on Sixth street. It will be 110 ft. wide and 418 ft. long. The entire structure is to be of reinforced concrete and brick; Henry E. Baton, Philadelphia, Pa., is the contractor.

BUFFALO, ROCHESTER & PITTSBURGH.—Work is now under way near Punxsutawney, Pa., on the construction of a new engine terminal, a 16-stall roundhouse and auxiliary facilities. The work includes changing the course of a highway from the east to the west side of the tracks for a distance of over one mile and ten miles of additional yard track will be constructed. It is expected that the work will be finished by January next.

ILLINOIS CENTRAL.—This company has awarded a contract to G. A. Johnson & Son, Chicago, for the following improvements at Memphis, Tenn.: The construction of new racks and bins in the storehouse, remodeling the mill building, erection of platforms and incline at the mill building, plumbing and sewerage work, construction of transfer table pit and engine hoist pit, and erection of coach yard building. The estimated cost of the work is \$50,000. A contract for additional work at Clinton, Ill., has been awarded to T. S. Leake & Co., Chicago. Eleven stalls in the roundhouse will be lengthened at a cost of about \$60,000.

SUPPLY TRADE NOTES

The Falls Hollow Staybolt Company has removed its Chicago office from the Fisher building to 654 Railway Exchange building.

C. W. Cross has been appointed district manager of the Oxweld Railroad Service Company with office at 233 Railway Exchange, Chicago.

The International Oxygen Company, 115 Broadway, New York, announces the resignation of P. J. Kroll as the company's representative for Pittsburgh and middle western territory.

H. F. Bardwell has been appointed New York district manager for the Vanadium-Alloys Steel Company, Pittsburgh and Latrobe, Pa., with offices at 30 Church street, New York.

Fayette H. Reed has been appointed special agent of the Acar Manufacturing Company, New York, covering the states of California, Nevada, Oregon, Washington, Arizona, New Mexico and Utah, with office at San Francisco, Cal.

Emil Tyden, inventor of the Tyden car seal, and vice-president of the International Seal & Lock Company, Chicago, has been commissioned a major in the army and assigned to the ordnance section, located at Washington, D. C.

Edmund Barany, machine designer of the Singer Manufacturing Company, Elizabeth, N. J., has assumed the duties of mechanical engineer and assistant to general superintendent of the Cleveland Twist Drill Company, of Cleveland, Ohio.

The Continental Construction Corporation has been chartered in Delaware with a capital of \$100,000 to manufacture railway supplies. The incorporators are: C. L. Rimlinger, M. M. Clancy, Wilmington, Del., and Clement M. Egner, Elkton, Md.

Berry Brothers, varnish manufacturers, Detroit, Mich., have prepared an illustrated folder containing instructions on how to recognize military insignia, together with a full page half-tone display of the various marks of rank and distinction in the army and navy.

The Ward Leonard Electric Company, Mt. Vernon, N. Y., manufacturers of electric-controlling devices and vitreous enamel insulation resistance units, announces that it is now represented in Cleveland, Ohio, by the Walter P. Ambros Company, with offices in the Arcade.

Morrill Dunn, vice-president of McCord & Co., and Fred A. Preston, manager of sales of the P. & M. Company, Chicago, have been commissioned captains in the Signal corps of the U. S. army and have been assigned to duty with the Air Craft Production Board in France.

The Walter A. Zelnicker Supply Company, St. Louis, Mo., has recently secured the services of W. H. Bramman, who is acting in the capacity of assistant to the president. Mr. Bramman before becoming associated with the Zelnicker Supply Company was connected with the American Carbon & Battery Company.

The Pacific Car & Foundry Company, Seattle, Wash., was recently incorporated to build standard railway equipment, logging cars, trucks, contractors' equipment, forgings, castings, iron and steel and railway supplies in general. The new company has taken over the business of the Seattle Car & Foundry Company and now operates fully equipped car plants both at Seattle, Wash., and Portland, Ore. The offi-

cers are: William Pigott, president; O. D. Colvin, vice-president and general manager; James F. Twohy, vice-president and treasurer; James E. McNery, secretary, and T. G. Hayward, director of purchases.

The Keith Railway Equipment Company, 122 South Michigan avenue, Chicago, recently bought 33 acres near Hammond, Ind., and has begun the construction of a shop, 200 ft. by 85 ft., for the construction and repair of tank cars. Later two other buildings will be added, one of which will be 350 ft. by 300 ft. and the other 200 ft. by 70 ft.

Warren R. Roberts, president of the Roberts & Schaefer Company, engineers and contractors, Chicago, has received a commission as major under the Quartermaster General as executive officer in charge of new emergency construction work during the war. Mr. Roberts left Chicago on October 22 to take up his active work and residence in Washington.

The Baldwin Locomotive Works, in the week ending October 20 turned out 72 locomotives. This is at the rate of more than 3,600 a year, compared with 1,989 for the year 1916 and 2,666 in 1906, which was the previous record year. The company is employing an army of 20,000 men and work on government orders engages every department.

John J. Harty, vice-president and general manager of the Canadian Locomotive Company, Kingston, Ont., has been elected president of the company. He is also a director of the Dominion Foundries & Steel Company and is a son of William Harty, who was, some years ago, president of the Canadian Locomotive Company and is still one of its largest stockholders.

On October 1, 1917, the New York sales offices of the Edison Storage Battery Company, long located at 206 West Seventy-sixth street, moved into larger quarters, at 209 West Seventy-sixth street, just opposite the old headquarters. At the new location many additional facilities have been installed to enable the manager, John Kelly, to take care of the increased business.

Frank B. Archibald, for the past five years eastern manager of the National Lock Washer Company, has been elected vice-president; J. Howard Horn, eastern representative for the past seven years, has been appointed sales manager. On or about December 1, offices will be opened in Philadelphia, Pa., and St. Louis, Mo., in addition to present offices in Chicago and Detroit, Mich.

The Westinghouse Electric & Manufacturing Company announces another increase in wages for shop employees aggregating nearly \$2,000,000 a year. Effective October 16, all employees observing shop hours, except munition workers, will receive an additional bonus of 10 per cent if they are on a salary or time-rate basis, and of 7 per cent if they are on a piece, premium or task basis.

William S. Bostwick and Chester A. Lyon, formerly with the Magnus Company, Inc., Chicago, announce the formation of the Bostwick-Lyon Bronze Company, of Waynesboro, Pa., and that they have taken over the entire plant of the Waynesboro Foundry & Machine Company, and have fully equipped it as a modern foundry for the manufacture of brass castings, journal bearings and babbitt metal.

The Blevney Machine Company, Greenfield, Mass., has recently been organized as a Massachusetts corporation and has purchased the entire business, plant, etc., of John C. Blevney, of Newark, N. J., manufacturer of a patented line of grinding and polishing machinery, also friction clutches. The company is now making ready a new modern factory at Greenfield and expects to have this new plant in operation within sixty days. W. S. Howe has resigned as treasurer and general manager of the Nutter & Barnes Company, and as general manager of the machinery division of the

Greenfield Tap & Die Corporation, to become president and treasurer of the Blevney Machine Company and will be the active head of this new concern. The Blevney patented two-belt grinding and finishing machines are an innovation in the metal finishing field.

J. J. Byrne has been appointed eastern representative of the Locomotive Stoker Company of Pittsburgh, Pa., with office at 50 Church street, New York City. Mr. Byrne entered railroad service in 1903, on the Cleveland, Cincinnati, Chicago & St. Louis as machinist apprentice. He served four years in this capacity at the Delaware shops. He entered the service of the Lake Shore & Michigan Southern as machinist in 1907, and remained with that company until 1909, at which time he entered the employ of the Locomotive Stoker Company as mechanical expert. Mr. Byrne will devote much of his time to the Southern roads.

Oscar F. Ostby, has opened offices at 2736 Grand Central Terminal, New York, to handle general railway supplies. He has been appointed eastern representative of the Grip Nut Company, Chicago, and manager of sales of the Glazier Manufacturing Company of Rochester, N. Y., the latter company making a complete line of oil headlights and reflectors and cases for all kinds of headlights. Mr. Ostby has been one of the energetic members of the Railway Supply Manufacturers' Association, having been its president in 1915-16. He has been much interested in the locomotive headlight field in the interest of the International Acetylene Association. Mr. Ostby was born March 5, 1883, and received his education in the public schools of Providence, R. I. From 1901 to November, 1904, he was engaged in publicity work. Since then he has been connected with the Commercial Acetylene Railway Light & Signal Company and the Refrigerator, Heater & Ventilator Car Company, serving the latter company as general manager.

Major P. G. Jenks, Quartermaster Officers' Reserve Corps and in civil life assistant to the president of the Standard Steel Car Company, Chicago, presented regimental and national colors to the Thirty-fifth Engineers at Rockford, Ill., on October 19, on behalf of car construction companies which have orders from the government. Very appropriately the presentation speech was made by Louis Pitcher, a civil war veteran, who exactly 53 years before (October 19, 1864) was color bearer in the Union army in the battle of Cedar Creek. The Thirty-fifth Engineers is a railway regiment which is being recruited for the purpose of doing car construction work on the American-operated lines in France.

H. P. Meredith, master mechanic of the Maryland and Delaware divisions of the Philadelphia, Baltimore & Washington, has resigned to go to E. I. du Pont de Nemours & Co. as engineer in charge of mechanical maintenance and shop methods, with headquarters at Wilmington, Del. He was born January 12, 1879, in Gloucester county, Virginia, and was educated in private schools in Virginia and public schools of Altoona, Pa. He entered the service of the Pennsylvania Railroad as a special apprentice in 1897. In 1901,

he became motive power inspector of the Buffalo & Allegheny Valley division at Buffalo; in 1903, he was promoted to assistant master mechanic of Altoona machine shops, and on July 1, 1905, was promoted to the position of assistant to the general superintendent of motive power at Altoona. He was made master mechanic of the Baltimore division at Baltimore, Md., on May 1, 1910, and on October 15, 1914, was promoted to master mechanic of the Williamsport and Sunbury divisions, with headquarters at Sunbury, Pa. On July 1, 1916, he was promoted to the position which he has just resigned. He is a member of the American Society of Mechanical Engineers, the Master Car Builders' Association, and the American Railway Master Mechanics' Association.

Clement F. Street has opened an office as consulting mechanical engineer at 50 Church street, New York. He will give special attention to questions of design and tests of railway equipment and specialties. Mr. Street at the age of 18 became a machinist apprentice at the works of the Buckeye Engine Company, and after three years entered the drawing room of that company. Later he became chief draftsman of the Johnstown Company, Johnstown, Pa., leaving after two years to become chief draftsman in the motive power department of the Chicago & St. Paul Railway, where he remained for four years. In 1892 he became mechanical editor of the Railway and Engineering Review of Chicago. Seven years later he went with the Dayton Malleable Iron Company and for nine years was engaged in designing and selling railway supplies for this company, for the Wellman-Seaver-Morgan Company, Cleveland, Ohio, and for the Westinghouse Electric & Manufacturing Company, Pittsburgh, Pa. In 1907 he started to develop a locomotive stoker with the financial assistance of the Westinghouse Air Brake Company, this work finally developing into the formation of the present Locomotive Stoker Company, of which Mr. Street is vice-president and director. In 1916 the John Scott Legacy Medal and Premium was awarded to Mr. Street on the recommendation of the Franklin Institute of Philadelphia for his work in developing the Street stoker.

Joseph T. Ryerson & Son

Joseph T. Ryerson & Son, Chicago, celebrated the seventy-fifth anniversary of its organization on November 1. The founder, Joseph T. Ryerson, came to Chicago in 1842 and located in a two-story brick building near Clark and Water streets. He secured a stock of \$20,000 worth of iron and began business as the accredited agent of Wood, Edwards & McKnight, of Pittsburgh. In 1879 he took his son, Edward L. Ryerson, into partnership, and upon his death on March 9, 1885, the business passed to his son. Edward L. Ryerson continued as president of the company until 1911, when he was made chairman of the board of directors. His sons, Joseph T. Ryerson, Donald M. Ryerson and Edward L. Ryerson, Jr., have entered the firm during the past 15 years and are now vice-presidents.

The Chicago plant of the firm has grown continuously in size with frequent changes in location to permit further expansion and at the present time is located at Sixteenth and Rockwell streets.

The eastern plant of the company occupies a 10-acre site on West Side avenue, Jersey City, at the junction of the Hackensack river and Newark bay. The building is 245 ft. by 470 ft., with a floor space of approximately 137,000 sq. ft. The company acquired a St. Louis plant by purchasing the W. G. Hagar Iron Company, thereby adding to its own products a line of mill, mine and boiler-makers' supplies manufactured by the Hagar Company. A new plant was opened at Detroit, Mich., on November 1, to take care of the increased demand for quick shipments of iron and steel in the territory served by that city.



O. F. Ostby

CATALOGUES

THOR DRILLS.—The Independent Pneumatic Tool Company, Chicago, has issued a folder illustrating the various types of piston air drills, pneumatic hammers and electric drills manufactured by that company. A table is also included giving the detailed characteristics and suitable service for each type of equipment.

LOCOMOTIVES.—The Baldwin Locomotive Works, Philadelphia, Pa., has recently issued Record No. 87 on the subject of military supplies. In this pamphlet is included a description of what the Baldwin Locomotive Works has done for the war, mentioning the Consolidation type locomotive built for the United States government and giving a record of the time in which this locomotive was built.

STAYBOLT IRON.—The Rome Iron Mills, Inc., 30 Church street, New York, has issued Bulletin No. 1 on Rome hollow staybolt iron. These staybolts are made with the tell-tale holes in them and the advantages obtained by using this material are explained. Illustrations showing the texture of the material from the nick and bend test and places in the firebox where these staybolts are particularly advantageous are shown.

POWER REVERSE GEAR.—The Economy Devices Corporation, 30 Church street, New York, has issued bulletin No. 115 describing the type "B" Ragonnet power reverse gear, which is a new design recently placed on the market. The catalogue enumerates the advantages of the power reverse gear and explains the cushioning principle of the type "B" gear. A sectional drawing of the gear is included showing the names of the various parts of the gear.

LOCOMOTIVE FEEDWATER HEATING.—The Locomotive Feedwater Heater Company, 30 Church street, New York, has issued its first bulletin describing the advantages to be obtained by heating the feedwater for locomotive boilers. The bulletin points out the saving to be made in waste heat feedwater heating. Charts showing what economy may be expected by heating the feedwater with exhaust steam from the cylinders are given, and illustrations are included showing the application of the feedwater heating apparatus to locomotives.

HEAT INSULATION.—The Magnesia Association of America, 702 Bulletin building, Philadelphia, Pa., has issued a leaflet of 40 pages called "85 per cent Magnesia and Heat Insulation." The purpose of the book is to present the latest and best information on heat insulation. Particular stress is laid on "85 per cent Magnesia" and its development is described. The various types of insulation made with this product and the uses to which this material may be put are mentioned. Illustrations of many interesting installations are included.

BRINELL HARDNESS TESTING MACHINE.—The Scientific Materials Company, Pittsburgh, has issued a 12-page pamphlet discussing the hardness testing of materials with special reference to the advantage of measuring the depth of the indentation made by the testing ball rather than its diameter. A description is given of the improved American model of the Brinell machine, with the appliances for measuring the depth of the penetration as well as other apparatus used in testing of this kind. The pamphlet also contains tables of hardness values.

GENERAL SUPPLIES.—The Gustin-Bacon Manufacturing Company, Kansas City, Mo., has recently issued catalogue No. 5 which gives a general description of the railway material handled by this company. The catalogue is divided

into five sections, covering the following articles: Belting and pulleys, hose and tubing, packing and gaskets, mats and mattings, miscellaneous articles, rules and data. It is bound in cloth and is well illustrated. The catalogue contains 215 pages and includes considerable data pertinent to the articles described.

COMPRESSED AIR APPARATUS.—The following new forms have been issued by the Ingersoll-Rand Company, 11 Broadway, New York: Form 8006, a 20-page catalogue on Imperial motor hoists and stationary motors; form 8212, a four-page bulletin on the Crown coal pick and core breaker; form 8213, a 16-page booklet on "Little David," pneumatic chipping, calking and scaling hammers, and form 9102, an eight-page bulletin on air receivers, pressure tanks and moisture traps. The catalogues are profusely illustrated and show tables of sizes and capacities.

JOURNAL BOX PACKINGS.—The Franklin Manufacturing Company, Franklin, Pa., has recently issued a 26-page pamphlet on the subject of journal box packings. It contains interesting information on the general subject, explaining the properties of good journal box packings and the results that should be obtained from it. The method of manufacturing the packings sold by this company is described, and the text is supplemented by interesting photographs. The materials used in the manufacture of packing are also described. A suggested specification for journal box packings is included.

GRINDING AND POLISHING MACHINERY.—The Webster & Perks Tool Company, Springfield, Ohio, has issued an extensive catalogue in loose-leaf binder form, describing its ball bearing and plain bearing grinding and polishing machinery. These machines include all sizes of bench and floor type grinders and wet tool grinders, both with the plain bearings and the ball bearings. This company furnishes some of its floor grinding equipment with direct connected motors. The catalogue contains illustrations of the various types of machines with their specifications, together with a description of the type of bearings used and various attachments that go with the grinders.

GEARED LOCOMOTIVES.—The Lima Locomotive Works, Lima, Ohio, has issued bulletin No. 2 describing Shay geared locomotives for industrial railways. These locomotives are designed particularly to operate on rails having sharp curves and turnouts on which rod connected engines can not operate. They are particularly suited for use in industrial plants as they will accelerate quickly and with them it is easier to spot cars more accurately than with rod connected engines. The bulletin gives an account of tests made with an 0-6-0 type engine and a Shay locomotive of equal tractive effort, to obtain comparative rates of acceleration when working under the same conditions and to determine the time required by the two engines to spot a given car at definite points. A brief description of the Shay locomotive truck is also included.

WOODWORKING MACHINERY.—The Oliver Machinery Company, Grand Rapids, Mich., has recently issued a complete catalogue describing its woodworking machinery and factory supplies. The catalogue contains 301 pages and includes descriptions of the various machines made by this company, including in addition to the woodworking machinery and general material for woodworkers, the Oliver engine lathes, speed lathes and turret lathes for metal work. A complete description is given of each machine and the supplies manufactured by this company, together with a list of the principal dimensions, capacities, etc. Among the products of this company are included wood saws, vises, blacksmiths' tools, clamps, woodworking lathes, metal lathes and accessories used in the woodworking trade. The catalogue is well illustrated and shows all the latest improvements this company has made in its products.

Railway Mechanical Engineer

Volume 91

December, 1917

No. 12

CONTENTS

EDITORIALS:

The American Society of Mechanical Engineers' Meeting.....	663
Railway Equipment Situation in Russia.....	663
More Motive Power Capacity.....	664
The Duty of the Men at Home.....	664
Locomotive Boiler Inspector's Report.....	664
The National Fuel Problem.....	665
Enginehouse Terminal Competition.....	665
New Books.....	666

COMMUNICATIONS:

Educate the Trainmen.....	666
The Work of the Men at Home.....	666

GENERAL:

Wabash 2-10-2 Type Locomotive.....	667
Conservation of Railway Material.....	670
An Innovation in Tender Design.....	673
Railway Power House Economics.....	675
Locomotive Design from a Maintenance Standpoint.....	678
Federal Locomotive Inspection.....	680

CAR DEPARTMENT:

Delaware & Hudson Steel Underframe for Wood Freight Cars.....	683
Hot Boxes.....	683
Refrigerator Cars for the B. & O.....	685
Emergency Air and Signal Hose Coupling.....	688
Modern Draft Gear Requirements.....	689
Narrow Gage Steel Hopper Car.....	692

SHOP PRACTICE:

Shield for Tempering Blast.....	695
Pneumatic Punching Machine.....	695
Angle Cock Grinding Machine.....	696
Chuck for Shaping Main Rod Brasses.....	696
Decreasing Engine Terminal Delay.....	697
Women Workers in Railroad Shops.....	702
Lubrication of Air Compressors.....	704
Rollers for Applying Eccentrics.....	706

NEW DEVICES:

Lewis Power Reverse Gear.....	707
Journal Polisher.....	708
A Demonstration of the Ductility of Steel Pipe.....	708
Jacks with Non-Revolution Screws.....	709
Tests of Moore Heater Car.....	710
McCoy Graphite Lubricator.....	710
Cast Iron Piston Rod Packing.....	711

NEWS DEPARTMENT:

Notes.....	712
Meetings and Conventions.....	714
Personal Mention.....	714
New Shops.....	716
Supply Trade Notes.....	716
Catalogues.....	720

The American Society of Mechanical Engineers' Meeting

It is with regret that we find that at its annual meeting the American Society of Mechanical Engineers abandoned its previous practice of holding a railroad session. Now, if never before, does the country, and the railroads in particular, need all the possible assistance of the technical societies. The railroads are sadly in need of more power. New power cannot be purchased and the old power must be improved. There are engineers in this society who are able from their experience and study of locomotive problems to give valuable and concrete information as to what might be done to make the locomotives more effective. The locomotive situation is serious. The railway mechanical department needs all the assistance it can get, and again we say, it is with regret we find the greatest organization of mechanical men in this country letting such a golden opportunity for being of real assistance to the railroads pass without a word.

Railway Equipment Situation in Russia

A report of an interview with Henry Miller, who went to Russia in June as a member of the United States Railway Advisory Commission, which was published in a recent issue of the Railway Age Gazette, gives us a clearer view of the true railway situation in Russia than anything we have yet had. There are about 20,000 locomotives, most of them compounds, whose average age is 24 years. They have an average tractive effort of 18,000 lb. and 10 per cent burn wood, 5 per cent oil and the balance burn coal. About 15 per cent of the power was found

to be in bad order when the committee arrived at Petrograd. Investigation showed that 2,500 additional locomotives were necessary adequately to handle the increased traffic due to the war.

The need for cars was not so great. Of the 580,000 freight cars having an average capacity of 16 tons, 8 per cent were in bad order. The committee recommended the addition of 40,000 new cars which with the locomotives were supposed to be supplied by the United States. An interesting feature of the Russian freight cars is that only about 20 per cent are equipped with brakes and only 13,000, which were built in America, have air-brakes. The braking is generally done by hand, the practice being to use a brake van or car for every fifth car in a train and to station a brakeman at each brake.

The method of train operation in Russia is particularly interesting. Mr. Miller stated that there is almost an entire absence of what in America is termed the operating department. It was the practice before the commission's suggestions were put into effect, to operate the engines and crews on short turn-around trips. The men were assigned to regular locomotives, which practice resulted in a very small mileage for each locomotive; because when the men needed rest or laid off on account of sickness or for other causes the locomotives were also taken out of service. By pooling the men and the locomotives the commission doubled the locomotive mileage and most of the congestion was cleared up by the end of August. The commission further divided the lines into 300 mile divisions, each in charge of a superintendent and a staff of 13 assistants, including trainmasters, despatchers, master mechanics, traveling engineers, etc. Some 350

experienced railroad men have been sent from this country to carry out the recommendations of the committee and to instruct the Russian railway men in American railway operating methods.

The recent change in the Russian conditions may, of course, affect the extent to which the United States will cooperate with that country.

**More
Motive Power
Capacity**

The transportation machinery of the railroads of this country is handicapped for the lack of motive power. New locomotives cannot be obtained.

The only thing that remains is to get more power from the existing locomotives. Some roads are doing this by the addition of boiler capacity increasing devices which enable them to haul trains at greater speeds, or by the enlarging of the cylinders to haul greater loads. One road in particular has made material increases in the tonnage rating of its locomotives by doing this. Another road is making a careful study of its entire power to see how far it can go to make the locomotives do more work. Still another road has by making careful tests of its standard locomotives, both on a stationary testing plant and on the road, found how it can increase the power of these locomotives with but minor changes in design, with an accompanying saving in the cost of operation of thousands of dollars.

With conditions such as they are, every effort should be made to do more work and haul greater train loads. Of particular importance is the tonnage rating given the locomotives. Cases without number have been found where either due to ignorance or carelessness the locomotives have not been given a tonnage rating as high as they are able to handle. It is here that the road foreman of engines may prove of invaluable assistance. There are instances where by more thorough instruction and supervision of locomotive operation, engines have been made to haul from six to seven per cent greater tonnage, which means that 16 locomotives will do the work of 17. The General Operating Committee for the Eastern Roads recommends that freight traffic on fast or reduced tonnage rating be suspended and that hereafter this freight be operated on full tonnage continuous movement schedules. This shows how necessary it is to load the power to its maximum and this maximum must be the real maximum, which can only be obtained by an accurate rating of the locomotives. As the capacity of these locomotives is increased by the addition of capacity increasing devices, they should be re-rated and made to do their utmost. This is where the mechanical engineers and mechanical staff officers can do their "bit," in the struggle which this country has entered into.

**The Duty of
the Men
at Home**

It sometimes becomes very apparent that many of those who are secure in their homes with a fat pay envelope coming in regularly and plenty of work

to insure a continuance of this prosperity for some time to come, do not fully appreciate what this terrible war means to us individually. If the Allies should not win this war it means that the German government with all its ambitions for world power will be a constant menace to the principles which we love and for which our forefathers fought. It is the duty of every man, woman and child in this country to do what he can to aid the government. This includes the conservation of food-stuffs, fuel and materials of all kinds. It means that every one must do his work more efficiently, more perfectly and more intensively.

Press despatches indicate how serious the transportation situation in this country is. Railroad men know further that the lack of sufficient and efficient motive power is one of the main contributory causes to the railroads' difficulty.

Without adequate transportation facilities the work of this country in the war will be greatly handicapped. The motive power department is coming into prominence because of inadequate and insufficient power more than it ever has before. Never have such great demands been made upon the men working in this department.

The work of repairing locomotives is hard and many times it has to be done under the most trying conditions. The men need all the encouragement and moral support they can get from their leaders. It is the duty of the supervising officers and foremen to give this in full measure. They must make the men thoroughly realize what their services mean to the railways and to the country. The men themselves must make sacrifices, as many of the railroad units are making in France. In addition to their hard labors at the front, despatches show that the railroad forces are ready to pick up arms and sacrifice their lives to repel the common enemy. They are giving all they can give. What a lesson it is for us at home! All the government asks of us is work—good, hard conscientious work—and it is the least we can do to give this in full measure and back up the boys who are sacrificing their lives for us. Make every man realize that he has a duty to perform and that even though his work is not of a spectacular nature, it is extremely necessary. By doing this we will have far more contented men, far more efficiently maintained power and an esprit de corps which will help the railways to make good.

**Locomotive Boiler
Inspector's
Report**

The sixth annual report of the chief inspector of locomotive boilers for the Interstate Commerce Commission has recently been made public and is abstracted elsewhere in this issue.

There is this year an increase in the percentage of locomotives found defective and an increase in the number of accidents and casualties. Some of this increase is due to the fact that during the fiscal year 1917 the records include those concerning the entire locomotive and tender, while during the fiscal year of 1916 only about ten months include the entire locomotive. The chief inspector says, "The increase has no doubt been brought about by unprecedented operating conditions which, together with the shortage of labor and material, has made difficult the proper maintenance of locomotives." In addition to this we believe that due to the shortage of power, locomotives which under ordinary conditions would have been scrapped and replaced, have been put into operation without being properly inspected and properly repaired. The need for power should not be taken as an excuse for putting in service locomotives which are not in a safe condition to run.

The chief inspector also says that, "The fact that some carriers by diligent efforts and careful supervision of repairs have not only maintained the condition of their locomotives, but have actually improved it during the past year, thereby increasing operating efficiency, is evidence that it can be done under the present exacting operating conditions." We fully agree with this statement. Those roads that have done this have been doing their country a service and will be the ones to hold up the reputation of the railroads during the oncoming winter. Those roads that do not do this are living on their vitals and are, so to speak, slowly starving to death. Mention is made of this condition in the report, the inspection bureau having found that some railroads have been woefully neglectful of the running repairs.

Of the classified accidents mentioned in the report, the greatest increase was found in those pertaining directly to the boiler or its appurtenances. Mention is made in the report of the fact that much trouble is experienced, particularly on the old power with the specification card showing

the strength of boilers when patches have been applied or alterations made to them, cases having been found where locomotives were in service carrying much higher pressure than they should. It is such carelessness as this that causes the accidents and makes it necessary for the Federal inspectors to hold the power out of service.

Many of the accidents investigated by the inspection bureau indicate that they might have been avoided had reasonable inspection been made of the work and had the work been properly done. Supervision and inspection, as never before, are tremendously important factors at this time. The chief inspector lays particular stress on this fact and rightly so, for it is only by this means that the power can be kept in good condition.

The National Fuel Problem

The condition of the fuel market in this country is such as to affect practically every citizen. It is no longer an individual problem—it is a national

problem. We have got to conserve our fuel supply in order that others may live. There are four particular uses to which fuel is put that are under the direct influence of railroad men. The first and of greatest importance is the fuel used on locomotives. Next comes the fuel for providing power in shops. The third is the fuel used for lighting and heating railway buildings. The fourth is the fuel used in the home for domestic purposes. The situation is so serious that every one of these problems must be given consideration.

Fuel economy on locomotives is a subject that is not new to any of us. There is hardly a railroad in this country but has given it serious consideration. It has a new aspect, however. The much higher price of fuel requires an entire revision of the fuel economy campaign. With the railroad fuel bill \$100,000,000 or more greater than it was last year, the railroads can well afford to spend more money than they have to decrease the fuel consumption of their locomotives. Further than this it is their patriotic duty to do so. Making the coal evaporate more water, by making the locomotive boiler transfer more heat to the water, and by making the steam do more actual work in the cylinder means cutting down the fuel required. There are many ways of doing this—bring your locomotives up to date, maintain them properly and keep the boilers free from scale. With a good machine to work with the engine crew will learn a lot and will do their part, if properly instructed, towards the saving of fuel.

The shop is a fuel eater, but compared with the locomotive consumption is of but little importance. It requires a large amount of fuel, however, to keep it running. The losses there would on most railways be startling if they were known. See that the power plant is run properly. The railroad stationary power plant is notoriously inefficient. Remember that one manufacturing city has prohibited the use of shop whistles for calling the men to work, simply to save the coal which would be used to generate the steam for blowing them. That is how much coal means to some. See that the shop engines are working efficiently. Lubricate the line shaft and machines properly. Don't run machines unnecessarily. Have everybody in the shop appreciate the fact that wasted power means wasted fuel.

The lighting and heating requirements are also comparatively small, to be sure, but economy here will help. We must have sufficient light to work by and too often on a railroad it is insufficient, but when there is no need for a light it should be extinguished. Carry the thought of a prominent man in the railroad field as he went back to turn out the lights in his hotel room—"It will save the fireman's back." It will also save fuel. It is not what one of us does, but what all of us do—so issue instructions about leaving

unnecessary lights burning. The fuel used in heating, particularly in the offices, is almost never given the slightest thought, except perhaps when the boiler plant fails and the temperature is low. Generally it is the open window or the coatless man that keeps one from a turkish bath. Why not repair the valves in the radiator and turn the heat off? It will save coal!

The fuel problem at home interests us all. If we have the money to pay for coal we are fortunate if we can get it. Here we economize of necessity. It means so much to the people in the state of New York that the governor has issued a proclamation calling on the domestic users to save coal. This has been supplemented by instructions relating to the economical handling of household heating plants. Let the lesson you must learn of necessity at home be a guide to you in your work, whether you run an engine, or work in the shop or at a desk—Save Coal!

Enginehouse Terminal Competition

The response we have received to our call for papers relating to methods by which the performance at engine terminals may be improved has been gratifying. There were 13 papers contributed to this competition, all of which are good and most of them will be published in future issues. The papers awarded the prizes are published elsewhere in this issue. The judges based the awards on the constructive suggestions in the papers. Some of the contributors merely described existing organizations, which although they were interesting, were not just what was desired in the present case. Perhaps the most important thought brought out in all the papers submitted was the necessity for careful supervision of the work done at engine terminals and a thorough inspection of the power. Suggestions were made also for alterations or additions to terminals which may be readily made without interfering too much with the operation of the terminal.

Now, if never before, the power should be turned out of an engine terminal with the full assurance that it will do its work properly and reach the end of its run without delay. "Congestion" is on every railroad man's lips; we hear it everywhere. Congestion can only be relieved by moving the freight. The locomotives, therefore, are the key to the situation. They must be kept in repair, they must be kept efficient and they must be made more efficient if the railroads are to meet successfully the demands made upon them today. We are just starting on the worst season of the year. We have no reserve of power; there is nothing to fall back upon if our locomotives fail. They must be kept on the road as much as possible.

The burden which is now resting upon the enginehouse forces is great and the work they do is tremendously important. Every means must be taken to increase the efficiency of these men. Where an organization is weak, it should be strengthened. Supervision is of prime importance. It is only human nature for men to do only that which they have to do. If the standards are high, they meet them; if the standards are low, they meet them also, and do but little more. Supervision is the only means by which the standards can be raised and maintained. It will be money well spent to split the enginehouse force into gangs with an active and progressive leader at the head of each to see that the work is done properly. An organization well supervised can do more work with fewer men than a group of men working under no organization at all.

The enginehouse forces are working under a great deal of strain. In many places they are required to work out in the open with but little protection from the elements. Their work is very hard and trying. They must be encouraged by their leaders and made to realize how much depends upon them. Where it is possible, improvements should be

made, if of only a temporary character, to make their work easier and to assist them in putting the locomotives through the terminal with greater despatch. Inspection pits are of considerable importance and great assistance. Engine washing plants, such as have been described previously in these columns, assist greatly in keeping the engines clean so that they may be inspected more easily. An additional water plug here or there throughout the terminal may mean the saving of more cross switching or back hauling. Ash pits might be lengthened and locomotive cranes with clam shell buckets kept in readiness to clean the pits whenever they become full. Special jigs or devices in the house are necessary to facilitate doing the work. These should be installed without a question. There are many other things that may be done to make the work of this important branch of the service easier and the wide-awake enginehouse foreman will be on the lookout for just such things as these.

The railroads are short of power and will be shorter as the winter progresses. Therefore, make every man in the enginehouse organization realize how much depends upon him. He is the man on the firing line. It is his work that to a large degree will determine whether or not the railroads will successfully meet the exacting demands made upon them.

NEW BOOKS

Carnegie Shape Book. c52 pages, 5 in. by 7 1/4 in., illustrated, bound in leather. Published by the Carnegie Steel Company, Pittsburgh, Pa. Price, \$1.

In continuation of its previous practice, the Carnegie Steel Company has revised its shape book and is now presenting the sixth edition. In this edition the pages devoted exclusively to profiles of sections have been increased to 265 pages, in contrast to 227 pages which were given to this department in the fifth edition, published two years ago. The increase in the number of sections made standard by this company is due to the remarkable expansion in shipbuilding, to the extensive use of steel crossies for industrial and railway purposes, to the increase in the automobile industry, and particularly to the great development in the use of steel in frames for windows, door and skylights in modern factory buildings. The customary tables of weights of different shaped material are included. The book has a complete subject index.

Compressed Air for the Metal Worker. By Charles A. Hirschberg, 315 pages, 6 in. by 9 in., illustrated, bound in leather. Published by the Clark Book Company, 27 William street, New York. Price \$3 net.

This book has been written by the author for the purpose of gathering together under one cover practical information relating to the uses of compressed air. He has undertaken to confine himself to a discussion of the practical side of compressed air utilization and to tell the *how* and *why*. Where theory has been referred to it is discussed concisely and in non-technical language. The book has been written for shop owners, superintendents, foremen and machinists or other artisans. The subjects covered may be classified under power plants, factories, machine shops, forge shops, boiler and structural shops, etc. The first chapter covers in a historical way the progress made in compressed air advancement. This is followed by a discussion of the compressed air power plant, in which is given practical information regarding such plants for the benefit of those planning to make such installations. The details of the compressor and compressor accessories are also given with many illustrations, in a clear and interesting manner. Further information is given regarding the installation and care of compressors with their accessories. The author then discusses various tools and their uses, which can be operated by compressed air, this comprising the greater part of the book.

COMMUNICATIONS

EDUCATE THE TRAINMEN

BALTIMORE, Md.

TO THE EDITOR:

I have read with a great deal of interest R. J. Quintrell's communication entitled "A Protest! Educate the Trainmen" in your issue of November, 1917.

In these strenuous days when the railroads are called upon to handle an inconceivable increase in tonnage, with a very small increase in rolling stock, the cry has been sent forth to the mechanical department to do its duty to its country in keeping the trains moving. And this is as it should be. But Mr. Quintrell has touched a chord, which, if fully developed, will produce a sound well worth listening to. I have personally observed a number of times wanting destruction of railroad property by rough handling of trains, especially in switching. The resultant delays in switching out damaged equipment has more than offset any saving in time by rush operations, to say nothing of the expense in repairs incident thereto. Far too many times the break-in-twos on the road find their initial cause in the classification yards. I have known of instances where switching crews were required to handle a specified minimum tonnage daily, and the number of damaged ends was mute testimony to the manner in which this tonnage handling was accomplished.

A little talk now and then on the results of rough handling, giving figures to show the approximate cost of repairs to damaged equipment, and the loss of revenue from rolling stock standing idle on the repair tracks, together with suggestions regarding proper handling of cars, might go far toward solving our transportation problems, which are daily becoming more difficult.

ARTHUR W. NORTON.

THE WORK OF THE MEN AT HOME

COLONIE, N. Y.

TO THE EDITOR:

I have noted with much interest the move made by the supply men to furnish "tobacco" to the men of the engineer regiments. You will be interested in an organization we have formed in the Delaware & Hudson shops at Colonie, N. Y.

We have given about 70 of our men to army or navy, some to the engineer regiments and many to other parts of the service. Realizing that we at home also have a duty to perform, after sounding the sentiment of the shop, at a noon hour meeting, an organization was formed comprising practically to a man the full shop quota. Its purpose is:

(1.) To furnish periodically—approximately once each month—while the war lasts, to each fellow Colonie man enlisted in the nation's service, tobacco or some token of remembrance, together with a shop letter.

(2.) To keep in touch with those left at home who may be wholly or partially dependent on our fellow Colonie men at the front to the end that where a helping hand may be needed it will unobtrusively be extended.

(3.) By these means—to give to our men the encouragement had with the knowledge that we are back of them to a man, evidencing clearly our realization that the problem is a mutual one.

We have also placed an honor board in a conspicuous place, giving the location of the men in the service. Committees were formed as follows: Honor Roll, Purchasing, Reading, Home Letters, Helping Hand and Printing.

Don't you think that if every shop in the United States did the same it would be a splendid thing?

G. S. EDMONDS,
Shop Superintendent.

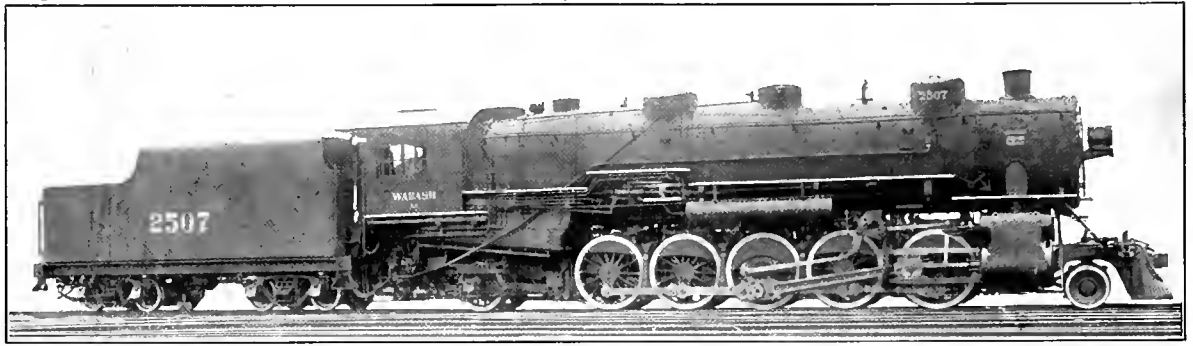

WABASH 2-10-2 TYPE LOCOMOTIVE

Exceptionally Large Boilers Make Possible High Sustained Capacity; Rated Tractive Effort 69,700 lb.

THE Wabash Railway has recently received 25 large 2-10-2 type locomotives from the American Locomotive Company. These engines have replaced others of the Mikado type on the Decatur division between St. Louis, Mo., and Chicago.

On this division the heaviest traffic is in the northbound direction, against which the ruling grade is .4 per cent, with the longest single grade four miles in length. The average train load for the 2-10-2 type locomotives northbound is 5,000 tons, as compared with 3,500 tons for the Mikado type locomotives previously in service in the same territory. This is an increase for the 2-10-2 type of 42.8 per cent in tonnage and a decrease of 30 per cent in train mileage has thereby been effected. These locomotives have

of 38.4 per cent has been obtained and the train load has been increased 42.8 per cent.

As a rule, an increase in weight results in a proportionately greater increase in tractive effort. In this case, however, the percentage increases in weight and tractive effort are approximately the same because of the particular attention which has been given to the proportioning of the boiler. It is of the extended wagon top type with an outside diameter at the first barrel course of 87 $\frac{9}{16}$ in. The largest barrel course has an outside diameter of 98 in. The boiler is fitted with 253 tubes, 2 $\frac{1}{4}$ in. in diameter, and 48 superheater flues, 5 $\frac{1}{2}$ in. in diameter. The length between tube sheets is 23 ft.

The firebox has a grate area of 80.2 sq. ft. and is fired

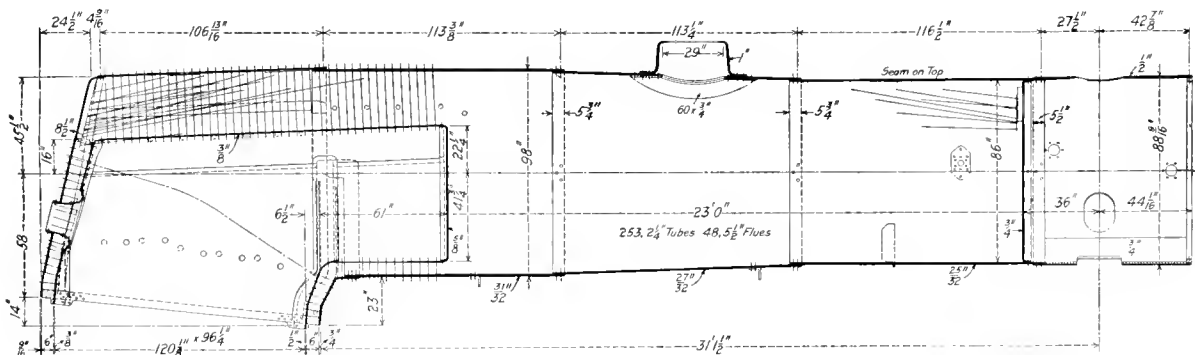

Longitudinal Section of the Boiler for the Wabash 2-10-2 Type Locomotive

been used on troop trains with very satisfactory results, hauling as many as 30 cars at speeds of 35 miles an hour. The exceptionally large boilers and the mechanical stokers with which the locomotives are equipped have made this exceptionally high sustained capacity possible of attainment.

The new locomotives have cylinders 29 in. by 32 in. and a tractive effort of 69,700 lb., with driving wheels 64 in. in diameter. The total weight of the engine and tender is 591,900 lb. The Mikado type locomotives displaced by the new engines have cylinders 26 in. in diameter by 30 in. stroke and a tractive effort of 50,360 lb. The total weight of engine and tender is 423,800 lb. With an increase in total weight of 39.6 per cent, an increase in tractive effort

by the Street Duplex stoker. It is 120 $\frac{1}{8}$ in. long and 96 $\frac{1}{4}$ in. wide and is fitted with a Security brick arch carried on five arch tubes.

The heating surface of the firebox and arch tubes is 379 sq. ft. and the total evaporative heating surface of the boiler is 5,370 sq. ft. The superheater has 48 elements and a heating surface of 1,129 sq. ft.

According to Cole's ratios, a superheater locomotive having 29-in. cylinders and operating with 195 lb. boiler pressure produces a maximum cylinder horsepower of 2,954 at a piston speed of about 1,000 ft. per minute. On the assumption that each horsepower requires 20.8 lb. of superheated steam per hour, this locomotive working at maximum

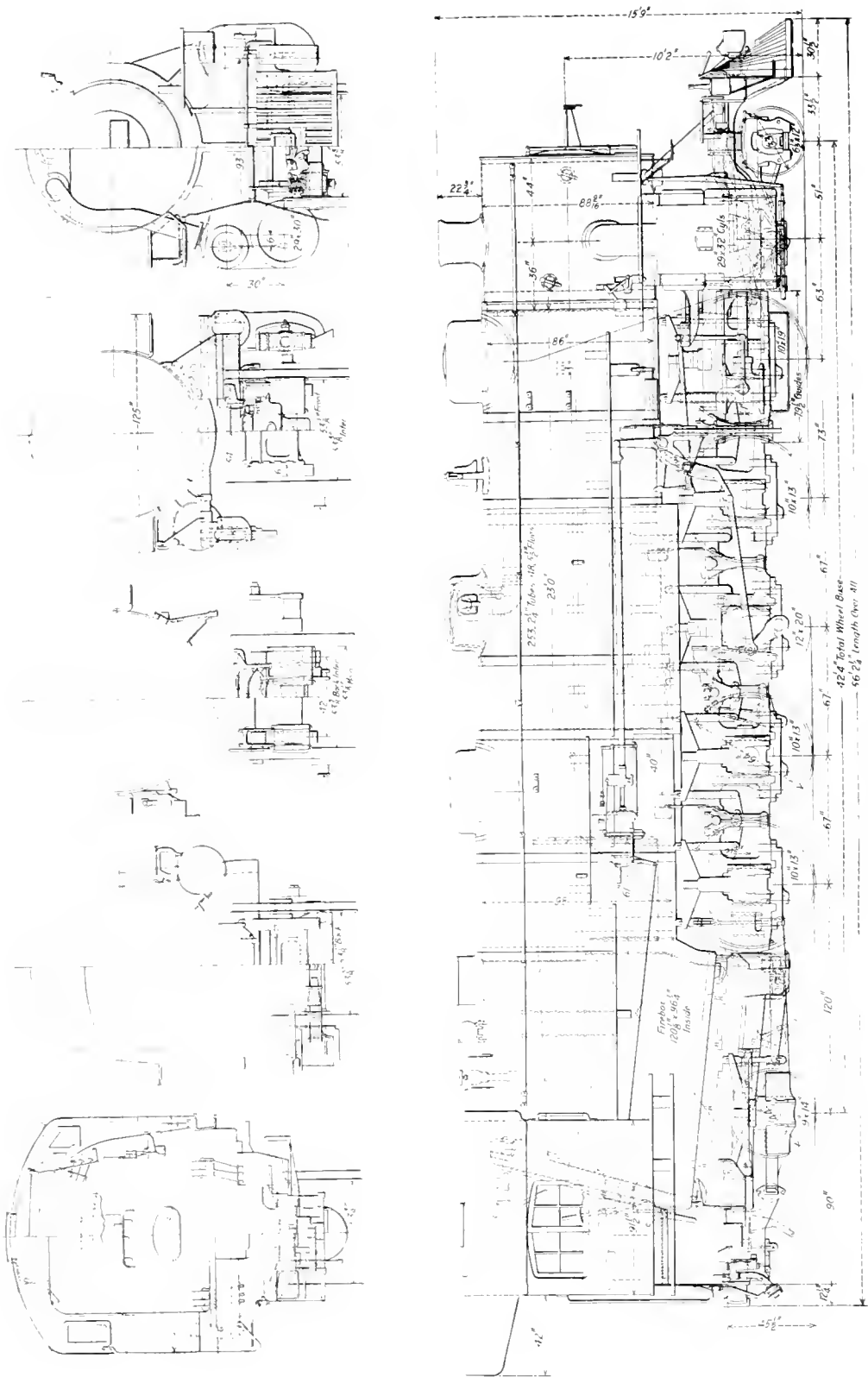

Elevation and Sections of the Wabash 2-10-2 Type Locomotive

boxes. Among other specialties with which the locomotives are fitted are the Woodard throttle valve, Radial buffers and Foulder solid back end main rods.

The principal data and dimensions are as follows:

<i>General Data</i>	
Gage	4 ft. 8½ in.
Service	Freight
Fuel	Bit. Coal
Tractive effort	69,700 lb.
Weight in working order	395,000 lb.
Weight on drivers	314,000 lb.
Weight on leading truck	28,500 lb.
Weight on trailing truck	52,500 lb.
Weight of engine and tender in working order	591,000 lb.
Wheel base, rigid	16 ft. 9 in.
Wheel base, driving	22 ft. 10 in.
Wheel base, total	42 ft. 4 in.
Wheel base, engine and tender	78 ft. 4½ in.
<i>Ratios</i>	
Weight on drivers ÷ tractive effort	4.5
Total weight ÷ tractive effort	5.7
Tractive effort × diam. drivers ÷ equivalent heating surface*	1,648.1
Equivalent heating surface* ÷ grate area	85.3
Firebox heating surface ÷ equivalent heating surface* per cent.	5.5
Weight on drivers ÷ equivalent heating surface*	45.6
Total weight ÷ equivalent heating surface*	57.4
Volume both cylinders	24.5 cu. ft.
Equivalent heating surface* ÷ vol. cylinders	281.4
Grate area ÷ vol. cylinders	3.3
<i>Cylinders</i>	
Kind	Simple
Diameter and stroke	29 in. by 32 in.
<i>Valves</i>	
Kind	Piston

Diameter	14 in.
Greatest travel	7 in.
<i>Wheels</i>	
Driving, diameter over tires	64 in.
Driving, thickness of tires	4 in.
Driving journals, main, diameter and length	12 in. by 20 in.
Driving journals, others, diameter and length	10 in. by 13 in.
Engine truck wheels, diameter	33 in.
Engine truck, journals	6 in. by 12 in.
Trailing truck wheels, diameter	44 in.
Trailing truck, journals	9 in. by 14 in.
<i>Boiler</i>	
Style	E. W. T.
Working pressure	195 lb. per sq. in.
Outside diameter of first ring	87 9/16 in.
Firebox, length and width	120½ in. by 96½ in.
Firebox plates, thickness	Crown, sides and back, ¾ in.; tube, 5/8 in.
Firebox, water space	6 in.
Tubes, number and outside diameter	253—2¼ in.
Flues, number and outside diameter	48 5½ in.
Tubes and flues, length	23 ft.
Heating surface, tubes and arch	4,991 sq. ft.
Heating surface, firebox and tubes	379 sq. ft.
Heating surface, total	5,370 sq. ft.
Superheater heating surface	1,129 sq. ft.
Equivalent heating surface*	6,883 sq. ft.
Grate area	80.2 sq. ft.
<i>Tender</i>	
Tank	Water bottom
Frame	Cast steel
Weight	196,000 lb.
Wheels, diameter	33 in.
Journals, diameter and length	6 in. by 11 in.
Water capacity	10,600 gal.
Coal capacity	13 tons

*Equivalent heating surface = total evaporative heating surface + 1.5 times the superheating surface.

CONSERVATION OF RAILWAY MATERIAL*

Possibilities for Getting More Service from Used Material and Using New Material Without Waste

BY M. K. BARNUM

Assistant to Vice-President, Baltimore & Ohio, Baltimore, Md.

“CONSERVATION OF MATERIAL” is a broader term than reclamation, the one frequently used, and, therefore, I think preferable. The reclamation of material has commonly been limited to the sorting of old material, particularly scrap, and picking out such parts as could be repaired and restored to service. Conservation goes much further than that because it is defined as “the preservation of natural resources for economical use.” The saving and economical use of material, in any manner, may be considered as the conservation of material. Most of the suggestions I will offer pertain to the collecting and sorting of material which is either serviceable or can be repaired for service, and some other items that may properly be considered in this connection.

The present prices of most material that the railroads use are from twice to four times what they were two or three years ago, and the value of scrap has increased somewhat in proportion, so that it is more profitable now to work over old material than it was then.

The first and most important thing is to collect the old material, and it is surprising to see how the small bits of iron and steel, such as rivet heads, nuts, washers, etc., that are a by-product of repairing cars, count up when gathered together in a pile. The best way to show the value of this small scrap that, ordinarily, is thought to be worthless, is to pick it up and keep an account of the labor and weight of material collected, and the result will be very convincing. As an example—not long ago at one of our steel car repair tracks boys were employed to gather rivets and rivet heads and in four or five weeks collected about 40 tons, worth over \$1,300 at a cost of about \$100 for labor. At another yard men were unloading yard cleanings into a swamp to release the cars and to fill the swamp. It was noticed that in this

stuff there were some small bits of iron, which the men were instructed to throw into a box, and in a month they had saved about 30 tons of scrap worth, approximately, \$1,000.

The scrapping of old cars leaves many truss rods, arch bars and other kinds of iron and soft steel, which can be worked over into new forgings, and our road has a rolling mill in which such pieces are worked down into bar iron for grab irons, safety appliances, etc. This mill, which cost approximately \$10,000 installed, produced a net profit, in the first six months of this year, of over \$40,000. Some roads have questioned the advisability of installing such a plant, but I see no reason why any railroad which has a considerable amount of rolling stock cannot profitably use a re-rolling mill.

In gathering up and sorting scrap iron from cars and locomotives and track work it is always found that a considerable amount of good material is brought in, which should be carefully culled out, as much of it can be returned to service with slight repairs. Brake shoes which are good for more mileage are often found in the scrap, having been taken off because they would not make the long runs, and these brake shoes are sorted out and applied to cabooses, cars and locomotive tenders that are on short runs.

It is hardly necessary to quote in detail the increases in prices of locomotives and cars, but I have some figures here which show that in the two years between May, 1915, and May, 1917, there was an average increase of 50 per cent in the cost of steel passenger cars, 75 per cent in locomotives and 75 to 100 per cent in freight cars.

It was formerly the practice of many roads, when their freight cars had reached the limit of their profitable life, to burn them so as to get the scrap iron out in the easiest way, but it has been found that burning iron reduces its value approximately 10 per cent as scrap, and the wood is de-

*From a paper read before the New York Railway Club.

stroyed. Tests which we have made show that the cost of dismantling a freight car is from \$5 to \$10 and saving the wood in condition for further use, results in a net profit of from \$10 to \$20 per car, according to the design. Our road has built many platforms, fences, storage bins, etc., and by using such second hand material we make a perfectly good job at small cost.

Many roads have reclamation plants, and I think they are all working profitably. The more common practices of cutting bolts to shorter lengths, rethreading them, repairing brake beams and sorting out the usable material, such as nuts, washers, etc., are followed on nearly all roads. The road with which I am associated has three such plants, the largest being at Zanesville, O., where we handle anything that is worth working over and fit it for service. There is a tin shop where we repair oil cans, lamps and tinware of all kinds. We have a shop where signals which have been replaced with new or larger sets are thoroughly overhauled, tested and prepared for installation at less important points. There is a saw-mill at which second-hand bridge timbers and various kinds of pile butts, etc., mostly coming from the maintenance of way department, are worked over into usable sizes, and they are prepared to fill orders for a large variety of finished material for buildings, car braces, car siding, roofing, etc. Some of the pieces are large enough to make good track ties, while the small pieces can be used for repairing hand cars, push cars, etc. Most of that material is practically worthless until it is resawed, after which it is worth from \$20 to \$60 per thousand feet. At the same shop we save the scrap pieces of wood and reduce them into charcoal for dining cars and shops, effecting a saving of about \$90 a month.

Our road has a large number of locomotives equipped with stokers, which have proved so satisfactory that they are used on all new freight locomotives. After four or five years of service some parts wear out, and we have fitted out one shop for the reclamation of stoker material, where we can do almost any kind of work up to building a stoker complete.

The electric and gas welding processes have revolutionized a large amount of shop work which was formerly done by forging, riveting or in other ways, and I believe that there has been no one process introduced in the last ten years that has been of greater help to the railroads. The collars of worn car axles and sharp flanges on locomotive tires can be built up successfully; the latter operation is often done under the engine, thereby saving the cost of removing the wheels or tires. The building up of flat spots on tires and car wheels and of worn coupler locks and knuckles enables them to be retained in service, and a great variety of castings which break can be welded and made practically as good as new. One of the biggest savings that has been effected is by the welding of broken cylinders. One of our master mechanics told me, recently, that a saving of about \$4,000 had been made in one month by the welding of broken cylinders. The welding of firebox sheets, both for repairs and new work, is being done successfully, and in some railroad shops the entire firebox is welded up without the use of rivets except in the mudring.

Much track material is sent in as scrap which in the past had not been thought worth working over, but we have found that it pays to reclaim track spikes, nuts, washers, track bolts and anti-creepers, and much can be saved by building up worn switch points and frogs by the welding process.

The use of old ties has been studied by most railroads, and, in every case I believe, the conclusion has been that it does not pay to pick them up, bring them in to terminals and cut them up for firewood or similar purposes, because the expense of collecting and preparing them for use makes them cost as much, or more, than new wood. So the usual practice is to pile up old ties alongside the track and burn them.

Some of the larger roads have timber treating plants and there are several commercial plants which treat ties and timber. The fact that this treatment costs only about 25 cents a tie and doubles the life of the tie makes it an excellent proposition. The average railroad tie, in the middle and eastern United States, has a life of about 7 years, not treated, and, when treated, it runs to 14 years or more, the first price of the tie being the same in either case. In using treated ties it is customary to apply steel tie plates under the rails, to prevent the ties from being cut and spoiled by mechanical wear before they rot out.

One other very profitable department of reclamation work is the saving and repairing of grain doors. Some roads have a large grain business, and they have found that grain doors can be repaired for about 10 cents a piece, whereas, a new door will cost not less than 75 cents. The repairing of grain doors leaves a considerable amount of small pieces, which can be cut up and used for dunnage and powder strips, and also for making boxes for shipping nuts, bolts, etc.

The collection and baling of old paper for sale has recently been quite profitable, although for a time it was not worth while. One station on our road sold \$128 worth of old paper after a house clearing, and another sold \$700 worth within a year. Those are some of the larger stations, but they show the desirability of saving all old papers for sale.

Another item which has not received much attention in the past, because it was not thought worth while, is the saving of coal and coke which becomes scattered along the tracks in switching yards. When coal could be bought for \$1 a ton at the mines, coal thus reclaimed hardly repaid the cost of picking it up, but at the present high prices it is worth saving.

I have said that the most important thing is to collect the old material so that it can be sorted out and the good separated from that which is only scrap. As an inducement to the section men to pick up material along the tracks, one of our superintendents has offered prizes to the section foremen who pick up the largest number of one inch nuts, and, on another occasion, the largest number of oil cup caps. The result was surprising and gratifying. One foreman turned in about 300 and another one about 200 nuts, most of them as good as new.

Many railroads are using box cars with either inside or outside metal roofing, and when they reach their limit of life much of the roofing is fit for further service. It can be used for making stove pipe, pails, cans, for roofing buildings and for many other purposes.

Some of the secondary results of the conservation of material and the cleaning up of scrap are the improved appearance of the property, the greater orderliness and a stimulated interest on the part of the men in taking care of material.

Our company has studied the wastes in dining cars, and a great deal has been accomplished in reducing them. The prices of all supplies have gone up, but, by following the advice of the Federal Food Commission, the prices of meals have been kept down pretty nearly to what they were heretofore, while the quality has been kept up, and, at the same time, a considerable saving has resulted.

The use of stationery and office supplies has been watched, with some care on most roads, but the amount of it is so great on the average road that it is worthy of closer attention. We have one man who gives his entire attention to the study of requisitions and the inspection of stock on hand at various offices, with very profitable results.

Some reclamation operations that have been tried are of rather doubtful value, and it is a question whether they pay. Among these are the re-making of brooms, renovating caboose cushions and camp mattresses, retapping nuts and

tinning lanterns. The question of painting brake beams and springs, after they have been repaired, is open to discussion but I believe it pays.

Another important item of conservation, which is worthy of more attention, is the protection of material from the weather, especially near the seacoast, where there is a good deal of wet and stormy weather. All finished work, such as threads of bolts, nuts and pipe, should be protected from dampness, or they will soon become rusted beyond any possible use. The same is true of steel plates and many of the finished parts for locomotives; dressed lumber for car work ought to be protected from rain, snow and sun. The ordinary rough castings stand exposure for several years, but if small they will be seriously damaged in a few months.

As an example of the value of scrap, I have obtained the figures for a large road, which show that in 1916 over \$3,000,000 worth of scrap was sold and for the first six months of 1917 over \$2,000,000 worth.

The motto which the railroads have adopted to guide them in their work is "What can we do to help win the war?" and this test should be applied to every problem that arises, because that is the biggest question now before us. Therefore, the conservation of material is more important now than ever before and it is one of the things that will be most helpful in winning the war.

DISCUSSION

E. J. McVeigh, general storekeeper, Grand Trunk System: Material is money, first, last and all the time. Unfortunately the railways have not learned that simple fact. They have never taught their employees to think of material as money. Due to the peculiar nature of railway operation, costly material is placed in the hands of many men totally untrained in the handling and value of the material. How many trainmen have been told that a journal bearing costs \$6 when new and is worth \$4.80 after it has served its purpose, if it is returned to the stores department; that a steam hose is worth \$4.80 new and \$3.80 after it has been worn out?

The railway "material man" buys, receives, cares for and delivers new material, but in addition to this he should educate the men handling the material as to its value, both new and old. When the material has fulfilled its function it once more becomes material and the material man does not let go of it until he knows that it has been conserved. The material man should have the proper facilities and organization for doing this. The old method of selling all used material as scrap has made the scrap dealers rich. Those roads which have developed central scrap and salvage yards have found that it pays. Average figures show a net increase of \$4.85 per ton in the price received for scrap that is examined for usable material and sorted. In addition to this the reclaimed material is of great value to the car repair and shop men. It keeps them well supplied with material.

Neglecting the material for the convenience of the repair forces we have the \$4.85 net gain where a railroad handles its own scrap. A railroad will "make" three tons of miscellaneous scrap per year per mile of road operated. Thus a road of 4,000 miles will be able to save \$58,200 per year by handling its own scrap. In brass there is still a larger amount to be saved. The salvage in all hose is very large. What other department of a railroad on so small an investment can show so great a return?

W. F. Jones, general storekeeper, New York Central: If the materials throughout the world wasted today were saved and applied to proper uses, we would be confronted with an economic revolution tomorrow. When a man's hands are full, it is natural for him to be extravagant. It is born in him and nature has placed before him almost unlimited resources to be obtained at the expense of but little endeavor.

To change this inherent characteristic has been the life-

work of many men who have had the foresight to realize that, with our ever increasing population, the time will come when we will be confronted with a fight for existence.

In managing a business where men are employed, waste and extravagance will reduce the profits unless a watchful eye is placed on every detail of operation. This is not so difficult in a manufacturing plant where each individual workman is under the direct personal supervision of his foreman. Different conditions prevail in operating a railroad. While a large number of men are employed in buildings, under direct supervision, there is a vast army under indirect supervision, in the yards, along the road and on the water.

Conservation should begin with the quality of the material. It is not a paying proposition to use inferior material in a job that requires the best material that can be manufactured. A pair of wheels for a car may cost \$25.00 and the scrap value may be relatively high. The expense of that pair of wheels is not in the material, but in the delay to the car and contents, cost of switching, and labor of handling and of application and removal. If the life of a pair of wheels can be increased a year by using better material, even at higher price, would we not be conserving material?

Le Roy Cooley, general storekeeper, Central of New Jersey: Reclamation is so closely interwoven with conservation that I consider the two go hand in hand. If you can make the old material last a little longer or perform a further function you are conserving the new.

We have no elaborate scrap docks equipped with expensive machinery; we handle our reclamation work through our main locomotive and car shops, but not always with skilled labor, unless the class of work so demands. I will mention a few of the practices which we employ that might be of interest. No doubt all present have observed how the siding of box cars first becomes decayed at the sills and eaves, requiring renewal while the center portion is practically as good as new. Our practice is to cut off the decayed ends and use the siding as roofing.

A year or so ago all roads were obliged to re-build in a degree practically all of their equipment to meet the demands of the Interstate Commerce Commission, necessitating the removal of grab irons, brake wheels, brake staffs, cutting levers, etc. The old grab irons were used for the construction of bolts, as were also the brake staffs and cutting levers. The brake wheels which we were obliged to remove did not have sufficiently large brake staff fit to meet the requirements. We were able to reclaim practically all of these wheels by heating them and forcing the hole larger with a punch of proper size, with but little expense and little loss through breakage.

We have a rattler through which we pass all old or rusty nuts and washers. They are then sorted and those requiring re-threading are given such attention.

We found some time ago that it was possible in a large degree to reclaim our cast steel journal boxes through the electric welding process, by building them up in places where worn. This is also being done with front end coupler pockets, many of which require renewal on account of the pin holes becoming elongated. Our practice is to true up the hole by the electric welding process and return the pocket to service. Electric welding of bolsters and side frames is no doubt a common practice and the saving is enormous.

R. V. Wright of the *Railway Mechanical Engineer* called attention to the moral effect the reclamation of material has on the men. Before the war there was plenty of material and at the prices that prevailed at that time it was not economical to reclaim material to the extent that it is at the present time. The fact that material is scarce and that the cost has risen materially should be impressed upon the men so that this matter will be given the proper attention. In addition to the material the conservation of labor is a very important problem and should be given consideration.

AN INNOVATION IN TENDER DESIGN

Rock Island Lines Are Using Construction Which Eliminates Angle Iron at Bottom Edge of Tank

A TENDER which includes some unusual features has been designed by W. J. Tollerton, general mechanical superintendent of the Rock Island Lines, and is now being used on that road. The principal feature of the design is the method of construction adopted for the bottom of the tender tank which it is thought will result in considerable economy in maintenance.

The tender is of the rectangular type with a capacity of

The bottom sheet of the tank, instead of being joined to the side sheet by angles, has the edges flanged upward on all four sides with a radius of $5\frac{1}{4}$ in., and is riveted directly to the vertical sheets. The side sheets of the tank are rounded in the usual manner at the corners where they are riveted to the end sheets. At the four lower corners steel castings are used to join the curved surfaces of the bottom and side sheets, thus obviating a difficult job of flanging. It is intended to have the bottom sheet of the tank in one piece, but it has been impossible to secure plates large enough for this purpose under the present conditions.

The construction used on the lower seams eliminates one row of rivets for the entire distance around the tank, does away with the corner seam, which often leaks and is difficult to caulk, and brings the single remaining seam several inches above the bottom of the tank. The intermediate seams in the bottom and side sheets are made with the usual single riveted lap joint. The bottom sheet is $\frac{5}{16}$ in. thick, while all others are $\frac{1}{4}$ in. thick.

The sheets in the water space are braced by T-irons, which extend in one piece down one side, across the bottom and up the opposite side. These braces are spaced three feet apart and are bent at the lower corners to fit the curve of the sheet. By making the T-irons continuous across the three surfaces the plate is stiffened to such an extent that it is thought the vibration of the sheets, which often causes them to crack near the lower edge, will be entirely eliminated. Gusset sheets are also used to reinforce the lower edges, both at the sides and at the front.

The upper sheet of the water space is joined to the side and end sheets with angle irons in the usual manner. Splash

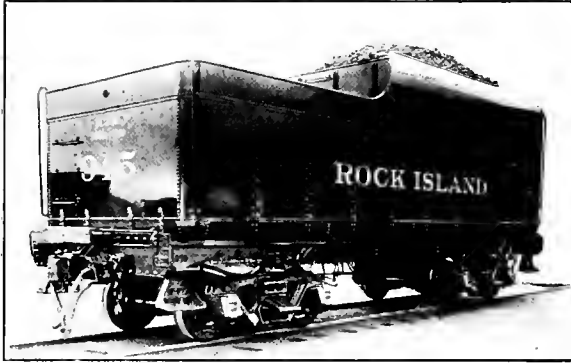

Rock Island Tender with Unusual Method of Joining Vertical and Bottom Tank Sheets

9,000 gal. of water and 16 tons of coal. It is 29 ft. long, 10 ft. wide, and the maximum height from the bottom sheet to the top of the coal space is 9 ft. $4\frac{1}{2}$ in. The water space

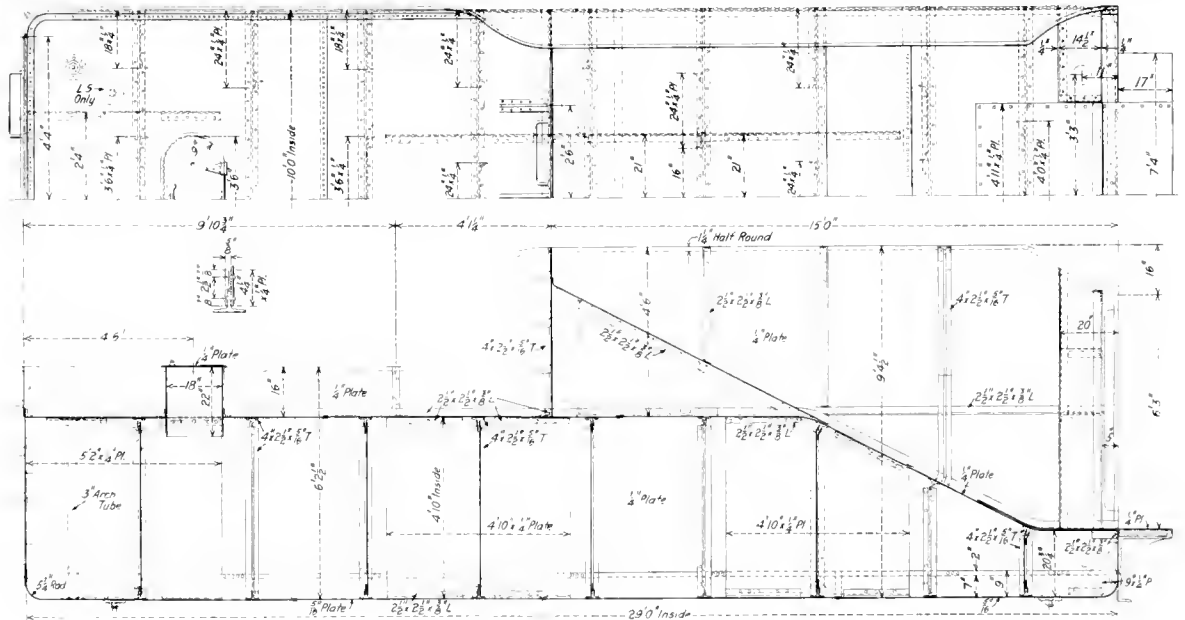

Rock Island Lines Tender Tank with Flanged Bottom Sheets

is 4 ft. 10 in. high at the back for a distance of 20 ft. 4 in., sloping from that point to a depth of $20\frac{3}{4}$ in., which is reached two feet from the front.

plates are placed crosswise and lengthwise in the tank and are fastened to the T-irons and to angle irons. At the points where the splash plates are riveted they are reinforced with

a lap plate which is shown in detail in one of the illustrations.

The coal space is 15 ft. long and 7 ft. 7 in. deep at the front, sloping uniformly from a point 2 ft. from the front of the tank. The sides are curved inward at the top to prevent the loss of coal. This construction, which originated on the Chicago, Burlington & Quincy, is now standard on the Rock Island. The curve at the top is formed by rolling the sheets,

slightly higher than the coal gates a much greater amount of space than is found in cupboards of the ordinary type has been provided without decreasing the coal space on the tender. The upper compartments are designed especially to furnish a convenient place for the enginemen to carry their clothes boxes. In the lower compartment is a steel box in which ice is placed for the purpose of cooling the drinking water, which is carried in jugs. The Lindstrom syphon extends up inside the cupboard and is supported by one of the shelves. The details of the arrangement of this device are illustrated.

The tender frame with which this tank is used is 8 ft. 2 in. wide over the side sills, and 9 ft. 2 in. wide over the end sills. The tank rests on 2-in. deck boards spaced about 2 ft. 9 in. apart and is anchored at the ends by the usual fastenings.

This type of tender has been in use in through-passenger

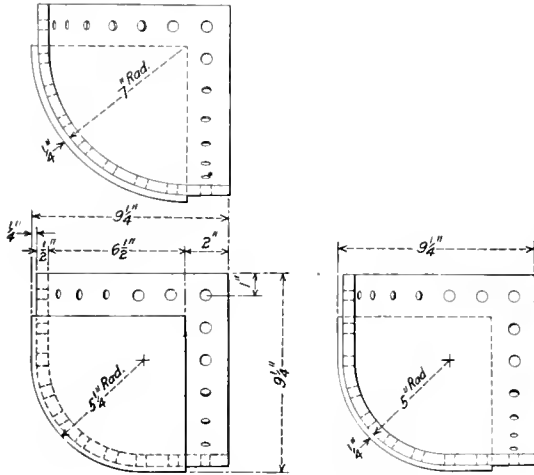

Cast Steel Corner for Tender Tanks

which are braced by angles and by one T-iron on each side extending diagonally from a point about half way down the side sheet to the slope sheet. A 1 1/4-in. half-round bead is used at the upper edges of the sheets. The rear portion of the slope sheet, which is raised above the water space, is stiffened by angle irons and supported at the end by T-irons

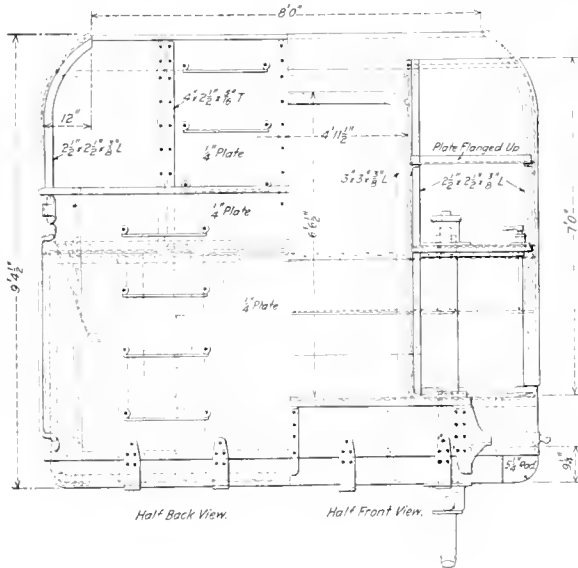

Front and Back End Elevations of the Rock Island Tender Tank

resting on the top of the water space. The upper and lower halves of the coal gates are made separate, as it has been found that opening the upper section of the coal gates materially improves the ventilation in the cab.

At the front corners of the tank there are two cupboards entirely open at the front, which provide an unusually handy place for tools and clothes. By carrying the cupboards up

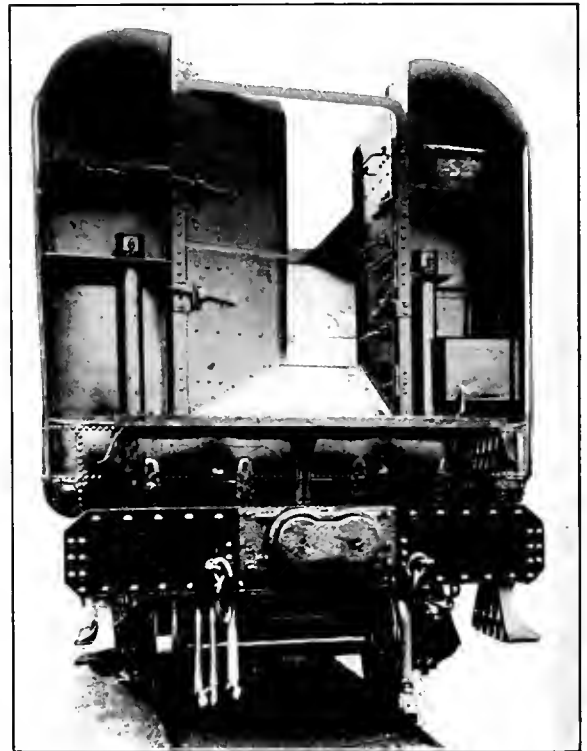

The Open Cupboards on the Rock Island Tender Are Exceptionally Roomy

service for three months and reports indicate that it has very good riding qualities. Tenders of similar construction will also be used with 30 freight locomotives now on order for the Rock Island. Application has been made for patents to cover the principal features of the design.

CHEMICAL HEATER FOR SOLDIERS.—*The Tech* of Boston tells of an individual heating apparatus for soldiers which Colonel Robert L. Howze is now testing to determine its practicality. The heater is not larger than a canteen and it is claimed that it will keep hot for 36 hours and then be recharged for another period. The heater is filled with a chemical fluid which is first heated by immersion in boiling water. The chemical action increases the heat to a high degree and maintains it for 36 hours. A new charge is a chemical substance no larger than a pea. The "stove" and fuel may thus be carried by a soldier in his haversack.

RAILWAY POWER HOUSE ECONOMICS

Construction and Operating Costs of the Average Power Plant Serving a Railroad Repair Shop

BY V. T. KROPIDLOWSKI

III

THE two preceding articles of this series have dealt with the general phases of shop electrification and the factors entering into the cost of power. The present article is devoted to the discussion of a concrete example, the cost of construction and operation of the shop power plant being analyzed and a comparison made with the cost of power purchased from a public service plant.

A repair shop of a capacity capable of turning out an average of 30 locomotives and 175 cars per month will be considered. The buildings in such a plant will have a cubical content of about 4,826,746 cu. ft. Providing one square foot of radiating surface for each 150 cu. ft. of building volume for heating this building, which is considered sufficient to meet shop requirements in severe winter weather, a plant of this magnitude will require 32,178 sq. ft. of radiating surface. One square foot of radiating surface will condense approximately 0.4 lb. of steam

an investment of this magnitude unavoidable, the question immediately rises whether the additional investment required to extend the power plant facilities to meet the complete power demands of the shop will not make possible a lower rate for power than can be obtained if power is purchased from a public service plant.

An analysis in detail of the power required for machine tool equipment in a shop of the capacity herein submitted is given in Table III. The total horsepower requirement of the shop tools and machinery is 570 hp. Adding to this the power required for the service pump, the coal chute hoist and locomotive hoist, which may be electrically driven to equal advantage in either case, and the electric lighting and welding loads, the total electrically driven load is 660 hp. As shown in Table IV, a rather high diversity factor of 65 per cent has been selected. On this assumption the maximum demand which may be expected is 429 hp., or 320 kw. We may therefore install with safety electrical equipment having a capacity of 350 kw. In Table V is shown in detail an estimate of the additional investment for power plant equipment to meet these requirements.

In a previous article* it has been shown that when a given boiler capacity is required to provide steam for shop heating, the power generated as a by-product of the heating system by passing the steam through a prime mover, will create only about 10 per cent additional demand on the boilers. In considering the minimum demand on the shop boiler plant when electric power for driving the machine tool equipment, lighting, etc., is to be purchased outside, the additional boiler capacity required to make up the deficit in steam for heating, after using the exhaust steam available, was found on this basis to be about 230 boiler horsepower. In the same way in Table V, where the additional equipment necessary to provide a complete shop power

TABLE I—MINIMUM REQUIREMENTS FOR BOILER CAPACITY IN THE SHOP PLANT

Power consumer	Capacity	Maximum developed	Average	Boiler
		hp.	hp.	hp.
Air compressor	2,000 cu. ft.	300	185	200
High pressure pump	300 gal.	15	4.5	20
Roundhouse blower line	100
Steam hammer	1,500 lb.	37	5	30
Steam hammer	1,100 lb.	27	3	20
Heating service	32,000 H.S.	429	230
Total	600

per hour and the maximum heating requirement of the plant will therefore require 32,178 x .4, or 12,871 lb. of steam per hour. The boiler capacity necessary to meet this maximum requirement, allowing an actual evaporation of 30 lb. of water per hour per boiler horsepower, is 429 hp.

Here is the need of an investment at the outset, which must be made irrespective of how the motive power for the

TABLE II—INITIAL INVESTMENT IN POWER HOUSE WHERE POWER IS PURCHASED FROM AN OUTSIDE SOURCE

Buildings and Equipment	Quantity	Unit		Cost per hp.	Cost per kw.	Total Cost
		Used	Cost			
Station building, bare building complete, including mill work, foundation, etc., not plumbing, lighting, etc.	117,000	cu. ft.	\$0.09	\$10,382
Boiler room equipment:						
Boilers, exclusive of setting	600	B hp.	15.00	\$15.00	...	9,000
Boiler settings	600	B hp.	8.00	8.00	...	4,800
Smoke flues	600	B hp.	.75	.75	...	450
Chimney, concrete	600	B hp.	5.00	5.00	...	3,000
Feed pumps	600	B hp.	.50	.50	...	300
Feedwater heater	600	B hp.	.80	.80	...	480
All piping and pipe covering	600	B hp.	8.00	8.00	...	4,800
Coal bin and ash-handling facilities	600	B hp.	1.00	1.00	...	600
Miscellaneous. Painting, instruments, runways, etc.	600	B hp.	.75	.75	...	450
Engine room equipment:						
Air compressor	300	E hp.	13.00	13.00	...	3,900
Foundation for above, concrete	55	cu. yds.	8.00	1.47	...	440
Service pump 14 in. by 9 in. by 12 in.	30,000	gal. per hr.	.014	420
High pressure pump 12 in. by 7 in. by 12 in.	24,000	gal. per hr.	384
Electrical switch board	350	kw.	2.50	...	\$2.50	875
Service equipment. Light, plumbing, tools, cranes, etc.	350	kw.	2.00	...	2.00	700
Piping for compressor and pumps	330	E hp.	4.00	1,320
General charges: Engineering, purchasing, supervision, etc.	350	kw.	4.00	...	4.00	1,400
Total	\$43,701

shop machinery is obtained; and this does not represent the complete investment, there being other steam requirements which bring up the total minimum shop boiler capacity to 600 boiler horsepower, as shown in Table I.

In Table II is presented an estimate of the cost of purchasing, installing and housing this equipment. The total amount of the investment thus required is \$43,251. With

plant is considered, this boiler capacity provided primarily for heating service, is available for the production of power and but 200 additional boiler hp. is required.

THE SHOP POWER PLANT

Fixed Charges.—Into the cost of the power enter the fixed charges upon the investment in the additional equip-

* See *Railway Mechanical Engineer* for July, 1917, page 373.

ment expressly required for the power generation. This investment is shown in Table V to be \$28,100. The fixed charges are divided about as follows:

Interest on the investment	5 per cent
Depreciation	5 per cent
Insurance, obsolescence, etc.	5 per cent
Total	15 per cent

The annual fixed charges are therefore \$4,228.50.

There need be no increase in labor cost, as there is not necessarily an increase in the power plant force; in fact in some

TABLE III. MACHINE TOOL POWER REQUIREMENTS
Machine Shop

Description of Tool	Size	Hp. to Drive
Drill press, radial	6-ft.	4
Drill press, universal	6-ft.	4
Drill press, radial	30-in.	1 1/2
Drill press, multiple	4 spindle	7
Drill press, vertical	36 in.	2
Drill press, vertical	42-in.	2
Drill press, sensitive	23-in.	1
Drill press, sensitive	20-in.	1
Drill press, sensitive	16-in.	1
Planer	36-in. by 16 ft.	12
Planer	30-in. by 10 ft.	10
Planer	24-in. by 6 ft.	5
Planer	40-in.	8
Lathe	30-in.	4
Lathes (two)	28-in.	6
Lathes (two)	24 in.	6
Lathes (four)	16-in.	3 1/2
Lathes (two)	16-in.	1 1/2
Lathe, fathor	2 in. by 24 in.	1 1/2
Lathe, turret	2 1/4-in. by 24 in.	1 1/2
Lathe, axle	No. 3	8
Lathe, Le Blond	80-in.	3
Lathe, single head	84 in.	3
Lathe, driving wheel	90 in.	15
Lathe, coach	42 in.	12
Quartern machine	86 in.	3
Boring mill	51-in.	7
Boring mill	36-in.	4
Truck wheel horer	36 in.	4
Slotter	12-in.	6
Slotter	15-in.	6
Slotter	11 1/2-in.	1
Bolt cutter, single	2 1/8-in.	2
Bolt cutter, single	No. 2	1 1/2
Milling machine	No. 3	2
Milling machine	No. 3	1 1/2
Tool grinder, single	8-in. wheel	2
Drill grinder, single	12-in. wheel	2
Yankee double grinder	14-in. wheel	1
Universal grinder	No. 2	2
Grinding grinders (four)	2-in. by 14-in. wheels	16
Guide grinder	6-in. by 12-in. wheel	2
Grindstone	48-in.	7 1/2
Hydraulic press	300-ton	5
Hydraulic press	150-ton	2
Hydraulic press	40-ton	2
Shapers (two)	24-in.	4 1/2
Shapers (two)	20-in.	4
Pipe threader	2 in. to 4 in.	2
Pipe threader	4 in. to 8 in.	1
Pipe threader	1/2 to 1 in.	1
Total connected load		223 1/2 hp.

Boiler Shop

Punch, 36-in. throat	1 1/4 in. through 1-in.	7 1/2
Shears, 60-in. throat	1-in. plate	10
Rolls	9-ft.	10
Bolt cutter, 4-spindle	1 1/2-in.	5
Stack riveter, 50 in. through	No. 6	3
Drill press	36 in.	2
Horizontal punch, 12 in. through	1 1/2 in. through 1-in.	7 1/2
Total connected load		45 hp.

Blacksmith Shop

Flue cutters (two)	6-in. flues	2
Flue welder	4-in. flues	2
Grinder, double	2-in. by 16-in. wheels	4
Fan	No. 6	7 1/2
Fan	No. 7	10
Grindstone	48 in.	1
Flue rattler	4 ft. by 21-ft.	1
Total connected load		34 1/2 hp.

Car Shop

Saw, rip	12 in.	3
Saw, rip, automatic	20 in.	10
Saw, rip	24 in.	5
Saw, automatic cut-off	36-in.	10
Saw, hand 5/8-in. blade	No. 5	3
Mortiser	3-in. by 18-in.	10
Planer, single head	24 in.	20
Planer, 4-sided, U.S.	6-in. by 15-in.	60
Planer, pony, single	No. 3	10
Garnet	2 1/2-in.	6
Borer, 4-spindle	1-in.	2
Borer, 2-spindle	48 in.	3
Grindstone	No. 7	1 1/2
Knife grinder, American	60 in.	35
Drill press	34 in.	2
Total connected load		128 1/2 hp.

Reclaiming Plant

Bolt cutter, triple	2-in.	4
Drill press	34-in.	2
Fan	No. 3	3
Pinch and shear, double	12-in. throat	3
Nut tapper, 6-spindle	2 in.	5
Trip hammer	100 lb.	5
Bolt header	1 1/2-in.	7 1/2
Total connected load		29 1/2 hp.

Saw Mill

Carriage saw	40 in.	25
Planer, single pony	24-in.	5
Saw, cut off	24-in.	3
Saw, rip	14 in.	5
Single machine, 1 saw		7 1/2
Saw grinder		1
Hand turning lathe		2
Total connected load		48 1/2 hp.
Total connected load for shop tools and machinery		569 1/2 hp.

instances there might even be a reduction. To be conservative, however, it will be assumed that a more skilled engineer will be required and an allowance of \$300 per year will be made to cover the higher wages. Lubricants, waste and other supplies will amount to about \$500 more per year, making the additional charge for labor and supplies \$600 a year.

Coal.—The coal chargeable to power comprises the coal equivalent of the heat lost between the boilers and the heating system when the heating system is in use; when no heating is required all of the coal burned is chargeable to power. The fuel cost depends upon the efficiency of the boilers and engines, the price of coal and the percentage of the total amount of steam generated which is used in the heating system.

The requirements of a compound non-condensing engine will be about 22 lb. of steam per indicated horsepower hour, or 29 lb. per kw.-hr. To be conservative, let us assume 40 lb. per kw.-hr. when no heating is required and 45 lb. when

TABLE IV.—POWER REQUIREMENTS FOR ELECTRICALLY DRIVEN EQUIPMENT

Conducted power load	570 hp.
Service pump, electric driven	13 hp.
Coal chutes, electric motor	10 hp.
Locomotive hoist, electric motor	7 hp.
Electric welding plant	10 hp.
Electric lighting	50 hp.
Total	660 hp.
Peak load, 65 per cent diversity factor	429 hp.
Average load, 50 per cent load factor	214 hp.

the engine is exhausting against the back pressure of the heating system. The evaporation of the boiler may be assumed as 8 lb. of water per pound of coal. The price of coal, of course, is a variable quantity and in the case of most railroads, under normal conditions it will range from 75 cents to two dollars per ton. The proportion of the steam generated which is used in the heating system is also variable, but for a purpose of this nature it may be assumed that all of the steam is required during a certain number of months of each year and none of it required during the remaining months. Strictly speaking, at the beginning and end of the heating season there are periods when but a moderate amount of heating is required and only a portion of the exhaust is then used, but it is simpler to determine the equivalent number of months during which all of the steam is required for heating. If during the four winter months all of the exhaust is used and during two months before and after this season it varies from 25 per cent to full capacity, it is then sufficiently accurate to assume that the heating season of eight months is equivalent to six months of maximum heating requirements.

Water.—An average price for water may be taken as eight cents per thousand gallons. During the heating season it is safe to assume that all but 20 per cent of the water is returned to the boiler; at other times all the water is lost.

With fixed costs and labor charges known, and the coal and water charges calculated for the conditions outlined

above, the charts shown in the illustrations have been prepared. The following example will serve to explain in detail the method of obtaining these figures.

Assume a heating season equivalent to six months of full load steam heating, when all the exhaust is used. During this period the coal chargeable against power is the equivalent of the heat lost between the boiler and the heating system, which should not be more than 10 per cent, but to be conservative it will be assumed as 20 per cent. The price of coal will be taken as one dollar per ton, which is a fair average of what it normally costs the railroads. The maximum power demand has been determined to be 320 kw. Assuming a load factor of 50 per cent of maximum power demand

The total charges for generating power at the rate of 160 kw. for 3,000 hours a year may be summarized as follows:

Fixed charges	\$4,228.50
Labor, oil and miscellaneous	600.00
Coal	\$135.00
	500.00
	735.00
Water	20.75
	92.20
	112.95
Total	\$5,676.45

During the year 3,000 x 160 = 480,000 kw. hr., are produced, giving a cost per kw. hr. of 1.18 cents.

In the same manner it is found that when the heating season is equivalent to only three months of full load heat-

TABLE V. ADDITIONAL INVESTMENT IN POWER PLANT TO CARRY ENTIRE SHOP LOAD

Article	Quantity	Unit		Cost per hp.	Cost per kw.	Total cost
		Used	Cost			
Main generating set						
Horizontal cross compound engine	450	E-hp.	\$18.00	\$18.00	\$8.00	\$8,160
A. C. generator	300	kw.	8.00	2,400
Auxiliary set:						
Vertical automatic high speed engine	75	E-hp.	16.00	16.00	...	1,200
A. C. generator	50	kw.	10.00	...	10.00	500
Foundations for above	70	cu. yds.	9.00	630
Piping for above	525	E-hp.	3.00	3.00	...	1,575
Wiring up generators, etc.	350	kw.	2.50	...	2.50	875
Additional station space	30,000	cu. ft.	.09	2,700
Additional boiler room space	25,000	cu. ft.	.09	2,250
Additional boiler capacity	206	B-hp.	39.80	7,960
Total	\$28,190

(45.8 per cent of the generator capacity), which is quite high for a repair shop plant, the average load is 160 kw. The working time per year may be taken as 3,000 hours,

ing and the price of coal two dollars, the cost per kilowatt hour is between 1.4 and 1.5 cents.

TABLE VI—AVERAGE FIXED CHARGES, LABOR AND SUPPLIES, CENTS PER KILOWATT HOUR

Load factor	5	10	15	20	25	30	35	40	45	45.8
Unit cost	9.20	4.60	3.06	2.30	1.83	1.53	1.31	1.15	1.02	1.00

TABLE VII—AVERAGE COAL AND WATER COST, CENTS PER KILOWATT HOUR

Cost of coal, dollars per ton	Months of exhaust heating			
	2	4	6	8
\$1.00	0.25	0.22	0.18	0.14
2.00	.47	.40	.33	.26
3.00	.69	.59	.49	.38
4.00	.91	.77	.64	.50
5.00	1.12	.96	.79	.62

TABLE VIII—AVERAGE COST OF POWER FOR THE YEAR, CENTS PER KILOWATT-HOUR

Cost of coal, dollars per ton	Months of exhaust heating			
	2	4	6	8
\$1.00	1.25	1.22	1.18	1.14
2.00	1.47	1.40	1.33	1.26
3.00	1.69	1.59	1.49	1.38
4.00	1.91	1.77	1.64	1.50
5.00	2.12	1.96	1.79	1.62

The effect of variations in the price of coal and the length of the heating season on the cost of power for the case assumed are shown in Table VIII. The rates for fixed charges only for varying load factors, are given in Table VI, and the cost of coal and water per kw.-hr. in Table VII. In Figs. 1 and 2 the same data has been presented graphically.

CENTRAL STATION COSTS AND RATES

There is hardly a central station that has as low a fixed charge as that of a railroad shop power plant, and it is doubtful whether the central station can compete on the

TABLE IX—EXHAUST STEAM AVAILABLE AND HOW IT IS USED

Steam Use by	P. Hp. average	Standard rate per hp. hour, lb.	Total steam per hour, lb.
Prime mover	215	26	5,590
Air compressor	185	40	7,400
High pressure pump	5	120	600
Deduct steam for heating feedwater			13,590
Deduct 20 per cent lost in engines			2,666
Available for heating			10,924
Steam required in heating system			2,185
			8,739
			8,826

which is based on a 10-hour day and excludes Sundays and the principal holidays.

The cost of coal during the six months heating season chargeable to power is:

$$160 \times \frac{3,000}{2} \times \frac{45}{8} \times 0.20 = \frac{\$1}{2,000} = \$135.00$$

The portion of the year when there is no exhaust steam heating, and when only part of the exhaust is used for heating, is equivalent to six months of straight non-condensing operation. The cost for coal during this period is therefore,

$$160 \times \frac{3,000}{2} \times \frac{40}{8} \times \frac{\$1}{2,000} = \$600.00$$

To the coal cost must be added the cost for water, which may be taken as eight cents per thousand gallons. During the heating season, the heating system returns 80 per cent of the boiler feed. The cost for water is then

$$160 \times \frac{3,000}{2} \times \frac{45}{8.33} \times 0.20 \times \frac{8 \text{ cents}}{1,000} = \$20.75$$

For the other six months the cost for water is

$$160 \times \frac{3,000}{2} \times \frac{40}{8.33} \times \frac{8 \text{ cents}}{1,000} = \$92.20$$

operating costs. The writer has looked through the Wisconsin Railroad Commission's annual reports and finds one of the public utility companies doing business in this section which has outstanding in stocks and bonds the sum of \$8,811,027.11, all of which is invested in property and equipment used for power generation. The total installed capacity of this company's equipment is 13,300 kw. Now, if we assume a load factor of 50 per cent, which is considered by central station men as a very good condition, the output is 13,300 x 365 x 24 x 5 = 58,254,000 kw. hr. per year. Making a very conservative allowance of only 12 1/2 per cent as the fixed charge, it amounts annually to \$1,101,382.39. This divided by the yearly kw.-hr. output gives a fixed charge rate of 1.9 cents per kw.-hr. This is the fixed charge only and does not include the items of labor and supplies incident to generation and distribution, general expenses, etc., included with fixed charges in the plant under discussion.

Of course, this does not determine the rate at which the central station is selling current. An examination of rate

schedules shows the prevalent rates to run about as follows:

DEMAND CHARGE	
For first 100 kw. annual demand.....	\$18.00 per kw. year
For next 100 kw. annual demand.....	14.00 per kw. year
Above 200 kw. annual demand.....	10.00 per kw. year
ENERGY CHARGE	
First 60 hr. use per month per kw.....	1½ cents per kw. hour
Next 60 hr. use per month per kw.....	1 cent per kw. hour
Above 120 hr. use per month per kw.....	¾ cent per kw. hour
Energy charge subject to five per cent. discount for prompt payment.	

Applying the schedule to the shop under discussion, the maximum demand will be 320 kw. and the load factor 50 per cent, making the average load 160 kw. The demand

LOCOMOTIVE DESIGN FROM A MAINTENANCE STANDPOINT*

BY W. H. WINTERROWD
Assistant to Chief Mechanical Engineer, Canadian Pacific

It is a question if there has ever existed an enginehouse foreman who has not, at some time or other, had the feeling that if some part of a locomotive had been designed a little differently, he could make repairs quicker, easier, and at less expense.

While in many instances he may have been justified in this feeling there are, however, cases influenced by other factors which may have been of greater importance from the standpoint of ultimate economy of operation.

The type and size of a locomotive have an important bearing on certain details of design. A discussion of the factors relating to the selection of the desired type and size is far beyond the scope of this paper as it would involve a thorough consideration of the economics of railway operation. Occasionally some detail of the resulting design, while undesirable from a maintenance standpoint, is unavoidable. However, the majority of locomotive details are free from other than purely local restrictions and may be designed almost entirely from a maintenance standpoint.

It should not be inferred from what follows that mechanical and operating men, as well as locomotive builders, have not given a great deal of consideration to the points mentioned. Very many locomotives in service today bear witness of such consideration. However, there are at present reasons for emphasizing and reviewing the importance of locomotive design from a maintenance standpoint.

Today, under changed conditions, the railroads are being called upon to render greater service than ever before. But little new equipment is available other than that which the railroads may build in their own shops. Repair shops are being worked to capacity. Skilled railway mechanics are scarce. Material of all kinds is difficult to obtain. All of which means that maximum service must be obtained from every bit of existing equipment. It is, therefore, essential to consider every legitimate means whereby the "out of service period" of a locomotive may be decreased and the "in service period" increased.

All new locomotives should be constructed to give maximum service with minimum maintenance. All locomotives being rebuilt, or modernized, should be turned out of the shops prepared to give similar results. Any improvement that can be made to any locomotive, new, modernized, or under repairs, which will result in increased service, increased efficiency, or decreased maintenance, will help to increase the capacity of the railroads.

The following covers briefly a few of the points worthy of consideration:

BOILER

It seems hardly necessary to state that a well designed boiler of ample capacity is easier and cheaper to maintain than one of smaller capacity and which has to be forced continually. The importance of ample capacity can scarcely be overemphasized, either from a maintenance or operating standpoint. Within its limits of weight and size a boiler should be designed to have a capacity as large as possible consistent with other governing factors. In this connection the values of the superheater, the brick arch, and the feed water heater are unquestionable. These values have been practically demonstrated from the standpoint of economy as well as locomotive capacity.

The maintenance of locomotive boilers is an important factor, the greatest difficulties being leaky flues, leaky mud rings, broken staybolts and cracks in firebox sheets.

Knowing that firebox heating surface does a great deal

*From a paper before the Canadian Railway Club.

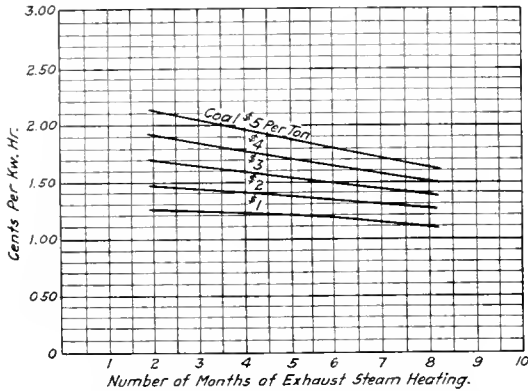

Fig. 1—Average Total Cost of Power in Cents Per Kw. Hr.

cost will amount for the year to \$1,800 + \$1,400 + \$1,500 = \$4,700. The energy charge for the year will amount to (60 x 160 x 1½ cents) + (60 x 160 x 1 cent) + (130 x 160 x 0.75 cents) = \$396 per month or \$4,752 per year. The cost per kw. hour is then 1.97 cents.

Therefore, the difference in rates per kw-hr. in favor of the privately owned power plant is 1.97 - 1.18 = 0.79 cents, or a net saving annually of 0.79 x 480,000 = \$3,792.

A question may be raised as to whether all the exhaust steam available in the shop plant will be utilized by the heating system, as has been assumed in this article. The writer has found from an analysis of various plants that the

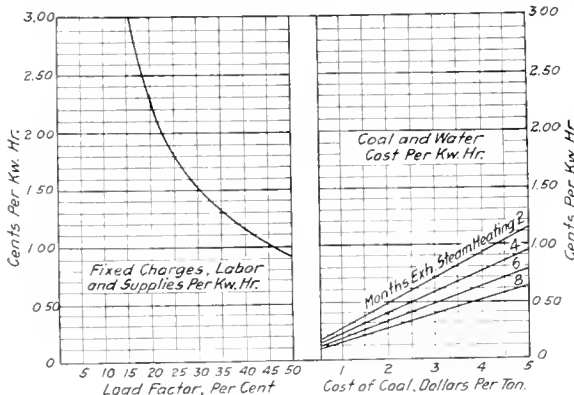

Fig. 2

Fig. 3

power requirements of the average railway shop plant are such as to provide a quantity of exhaust steam which balances very closely with the maximum amount required by the heating system. Table IX shows roughly the distribution of the exhaust steam supply in a plant of the size of that under discussion and an approximate balance is indicated. The steam hammers are not included, as usually the exhaust steam from these units can not conveniently be turned into the heating system.

more work per square foot than flue heating surface, boiler capacity does not depend upon long flues. Short flues are the easiest to maintain.

Many failures are frequently the result of crowding in too many flues, placing them too close to the heel of the flue sheet flange, and the use of too small a bridge. The bead on the flues, adjacent to the flanges should always rest on the flat surface of the sheet and never on the curved inside surface of the heel. With $2\frac{1}{4}$ in., or greater diameter flues, it is best that the width of bridges be not less than $\frac{3}{4}$ in.

Assuming that these points have been taken into consideration, it is important to see that the shop layout and driller follow the design. There have been cases where a layout has located flues incorrectly and also added one or more. It is also important that flue sheet holes be drilled the proper diameter as it is almost impossible to keep flues tight in holes that are too large.

The radii of door and back head sheet flanges should be studied in relation to the staybolt stresses. A moderately large back head sheet radius will reduce the stress in outer rows of bolts by transferring a portion of the load to the wrapper sheet.

Too small a door opening radius will frequently result in cracking of the sheet at this point because of insufficient provision for expansion.

Mud ring corners of ample radius will be easy to construct and maintain. Trouble due to small radius has, in many instances, been overcome by electric or acetylene welding the bottom edges of the sheets at this point to the mud ring.

Flexible staybolts reduce staybolt breakage. A careful investigation will indicate the zones of maximum staybolt stress and sheet movement. In these zones the flexible bolts will give good results and reduce staybolt renewals.

Grates should have sufficient air space, be free as possible from dead spots, and be easy to remove. Where certain kinds of fuel are used, properly designed dump grates may be a means of reducing the time the engine is on the ash pit.

As far as possible, all brackets, clamps, or fittings applied on the boiler or firebox should be so located that staybolts, rivets, or portion of caulking edges will be accessible with a minimum of labor.

In connection with the barrel of the boiler, points which may be mentioned are—throttle and dome arrangement which will permit interior inspection of the boiler without the removal of the standpipe; also the elimination, as far as possible, of all small studs. The latter will apply equally to all parts of the boiler under pressure.

Expansion slides, instead of an expansion sheet, under the front of the mud ring, will eliminate the maintenance of a considerable number of bolts and rivets. Proper consideration of all other expansion sheets will further reduce maintenance of many bolts and rivets and tend to eliminate the many resulting troubles as well.

FRAMES

Frames should be of ample cross section and well braced to hold them rigid. Maximum cross section may be of little avail unless accompanied by sufficient and properly located bracing. In this connection, it hardly seems necessary to mention the advantages of a valve gear located outside the frames. The outside gear has made possible better frame bracing, to say nothing of the advantages of easier inspection and maintenance of the gear itself.

As far as possible, bolt holes in frames should not be located where stresses are greatest.

Where cylinder design will permit, a one piece frame with a top tie splice seems desirable. Where large cylinders prevent the above arrangement, a one-piece frame with

ample depth under the cylinders, and having no reduction in thickness, will give excellent service.

MOTION WORK

All bearing pressures should be as low as consistent with good practice in order to reduce wear and resultant replacement. Ample pin length is desirable in order to obtain lateral stability. Arrangement of motion work and design of back steam chest and back cylinder covers should be such that both valve stem and piston rod packing will be easily accessible.

Where possible a piston rod of sufficient length to permit piston ring renewals without the removal of the rod from the cross head will reduce maintenance cost.

Rod bolts and wedges may be dispensed with by the use of solid bushes. Rods should be designed and arranged so that they may be removed with a minimum of labor.

Valves of light weight will reduce the load on all valve parts and result in reduced maintenance.

Selection of high grade, close grained, cast iron for cylinder and valve bushings, piston heads and rings, and in some cases rod bushes, is more than warranted in view of the increased mileage obtainable and the corresponding decrease in maintenance.

If conditions permit the consideration of heat treated, or alloy steels, unbalanced forces may be very materially reduced by the use of light reciprocating parts. The reduction of such forces will in turn tend to reduce the maintenance of pins, bushings, etc.

EQUALIZATION

Locomotives should be equalized so as to secure the most efficient guiding power from both leading and trailer trucks, or wheels. This involves the proper distribution of weight and a means of keeping the proper weights on the various axles at all times.

In general, the best results seem to be obtained by dividing the equalizing system so that the division between the front and back systems is as directly under the center of gravity of the locomotive as the wheel base and other conditions will permit.

The spring gear and equalizing system should receive particular attention when being erected and also when being repaired. The tops of the driving boxes should be milled out squarely and in a plane parallel with the journal bearings. The equalizer and saddles should be fitted to their seats squarely with the pin holes so that the engine will ride squarely on her springs and track properly. The same will apply to the trailer truck equalizers and spring rigging. Trailer trucks that do not carry the back of the engine level are responsible for much avoidable tire wear.

SPRING AND BRAKE RIGGING

A driver brake main fulcrum shaft in two pieces of equal length, the outer ends supported in bushed bearings integral with the main frames and the central portion supported by a sleeve, will give more even distribution of braking power and maximum accessibility for repairs and adjustments.

Brake cylinders, if at all possible, should be located vertically, to reduce packing wear and provide accessibility.

Brake shoe heads and hangers should be so constructed and hung that shoes will swing clear of the wheels when pressure is released and permit easy renewal of shoes.

The ratio of brake cylinder to brake shoe pressure should be kept as low as consistent, and should not exceed commonly accepted ratios. This will insure that false travel will be kept to a minimum.

PIPING

The importance of ample clamping and provision for expansion cannot be overemphasized. Piping should be as short as possible consistent with conditions. Accessibility is

of prime importance. Piping should be so located that there is no obstruction of washout plugs, arch tube covers, pads, etc. Where pipes pass through the front of the cab, provision should be made for clearance or for sleeve protection to prevent wearing or cutting.

The Canadian Pacific has found it a decided maintenance economy to place lubricator piping from cab to cylinders, etc., in a slightly larger wrought iron pipe where the feeds pass beneath the jacket and lagging. By this means the feed pipes can be removed or applied without the necessity of removing any outside covering.

MISCELLANEOUS

Removable liners on engine and tender truck pedestals makes it easy to take up wear and reduce pedestal renewals. To prevent rapid wear between the wheel hub liner face and the driving box sufficient provision for lubrication should be made.

Pilots made of scrap boiler flues cost less to maintain than those made of wood.

All oiling points should be made as accessible as possible. Handholds or small steps, properly located, to make some oiling points accessible, will soon pay for themselves.

Lubricator chokes should be placed in proper position and located as near to the cylinder, or steam chest, as possible. Proper inspection and maintenance of chokes has been found the key to many lubrication troubles.

Boiler jacketing should be applied in sections so that panels can be removed with a minimum of labor.

The foregoing are but a few of the multitudinous details which merit most careful thought. But little mention has been made of the possibilities of simplified design by the use of cast steel. It is felt that with the development of the cast steel industry and the production of castings which are practically equivalent to wrought iron locomotive construction in the future may be greatly simplified. We are today using castings that ten years ago would have been deemed impossible to successfully cast. For example, one piece locomotive frames are now under consideration and will soon be in experimental service. These consist of the two main frames and all cross braces cast in one piece. This is an indication of the degree of simplification that may be obtained. The maintenance of such parts has in turn been made possible by the development of the art of electric and acetylene welding.

Good and far reaching results can be obtained by inviting criticism and suggestions from those directly responsible for construction and maintenance.

In conclusion, simplicity co-related with efficiency should be one of the keystones of locomotive design. This principle, which, in other words, is simply good judgment, will make for that degree of efficiency which will be reflected, not only in reduced maintenance costs, but also in the increased capacity of the locomotive plant as a whole.

FEDERAL LOCOMOTIVE INSPECTION

Abstract of the Sixth Annual Report of the Chief Inspector of Locomotive Boilers to the I. C. C.

THE tables given herein show in concrete form the number of locomotives inspected, the number and percentage found defective, and the number ordered out of service on account of not meeting the requirements of the law.

They also show the total number of accidents due to failure from any cause of locomotives or tenders and all parts and appurtenances thereof, and the number of persons killed or injured thereby.

The amendment to the locomotive boiler inspection law

any part or appurtenance thereof, during the year ended June 30, 1917, classified according to occupations:

	Year ended June 30			
	1917		1916	
Members of train crews:	Killed	Injured	Killed	Injured
Engineers	16	230	11	205
Firemen	21	304	12	225
Brakemen	13	60	9	74
Conductors	3	14	1	6
Switchmen	1	8	..	6
Roundhouse and shop employees:				
Boiler makers	11	1	11
Machinists	8	1	11
Foremen	1	1	3
Inspectors	3	..	3
Watchmen	5	..	8
Boiler washers	7	..	10
Hostlers	6	..	6
Other roundhouse and shop employees	2	19	1	21
Other employees	5	22	..	7
Non-employees	1	23	1	3
Total	62	721	38	599



A Locomotive Held Out of Service on Account of Steam Leaks

did not become effective until September 4, 1915; therefore, the record for 1916 includes accidents and casualties investigated under the amended law for 9 months and 26 days only.

The following table shows the total number of persons killed and injured by failure of locomotives or tenders, or

Briefly summarizing, for the purpose of comparison, the record of accidents caused by failure of locomotives or tenders, or any part thereof, which were investigated by this bureau, as required by the law as amended, shows a total of 616 accidents, with 62 killed and 721 injured thereby. Of these accidents, 389, in which 52 persons were killed and 469 injured, were due to failure of locomotive boilers or some part or appurtenance thereof, and this may properly be compared with the record of accidents and casualties investigated by this bureau under the locomotive boiler inspection law, as shown in former annual reports. Two hundred and twenty-seven of the accidents shown in this report, in which 10 persons were killed and 252 injured, were caused by failure of some part of the locomotive or tender other than the boiler and its appurtenances, and were investigated under the amended law.

Much of the increase in the number of defective locomo-

tives and the accidents and casualties resulting from failure thereof has, no doubt, been brought about by unprecedented operating conditions, which, together with the shortage of labor and material, has made difficult the proper maintenance of locomotives.

This, however, is not a justification for the operation by

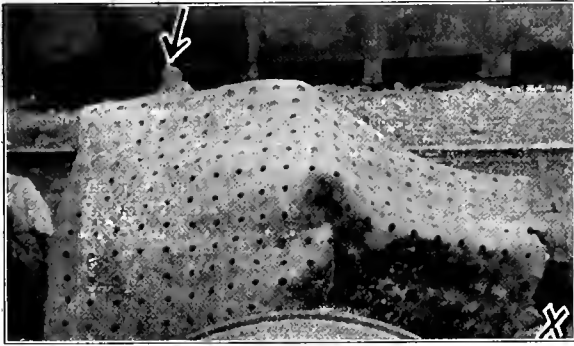

A Crown Sheet After an Explosion Due to Low Water

This crown sheet was welded by the oxy-acetylene process to the side, tube and door sheets. The arrow shows where it tore a piece out of the left side sheet and the cross shows how a small patch welded to the tube sheet was pulled off with the crown sheet.

any carrier of locomotives that are in an improper condition for service, and the fact that some carriers by diligent efforts and careful supervision of repairs have not only maintained the condition of their locomotives, but have actually improved it during the past year, thereby increasing operative efficiency, is evidence that it can be done even under the present exacting operating conditions.

The problems which have confronted this bureau in the

granted; first, by special instructions to inspectors to exert every effort, even to the extent of giving personal assistance when necessary, to facilitate the prompt and safe movement of traffic, and, later, with the approval of the Commission, by means of certain modifications of the inspection rules which the representatives of the carriers claimed would be beneficial to them during the period of the war.

It is to be regretted that some carriers appear to consider a congestion of traffic as a legitimate excuse for operating locomotives that are known to be in an improper condition for service and in violation of the law, and this is done to

LOCOMOTIVES INSPECTED, NUMBER FOUND DEFECTIVE AND NUMBER ORDERED OUT OF SERVICE		
	1917	1916
Number of locomotives inspected	47,542	52,650
Number found defective	25,909	24,685
Percentage found defective	54.5	47
Number ordered out of service	3,294	1,943

NUMBER OF ACCIDENTS, NUMBER KILLED AND NUMBER INJURED		
	1917	1916
Number of accidents	616	537
Number killed	62	38
Number injured	721	599

an extent that, I believe, fully justifies the statement that on such roads running repairs are neglected to an extent which, if continued, will cause serious interference with the movement of traffic during the coming winter in spite of the most diligent efforts of the limited force of Federal inspectors to enforce maintenance of locomotives as required by the law.

During the year 668 applications were filed for extension of time for removal of flues, under the provisions of rule 10. Our investigation showed 56 of these locomotives in such condition that no extension could be granted under the law. Forty-eight were in such condition that the full extension requested could not be granted, but an extension for a shorter period was allowed. Fifty-four extensions were

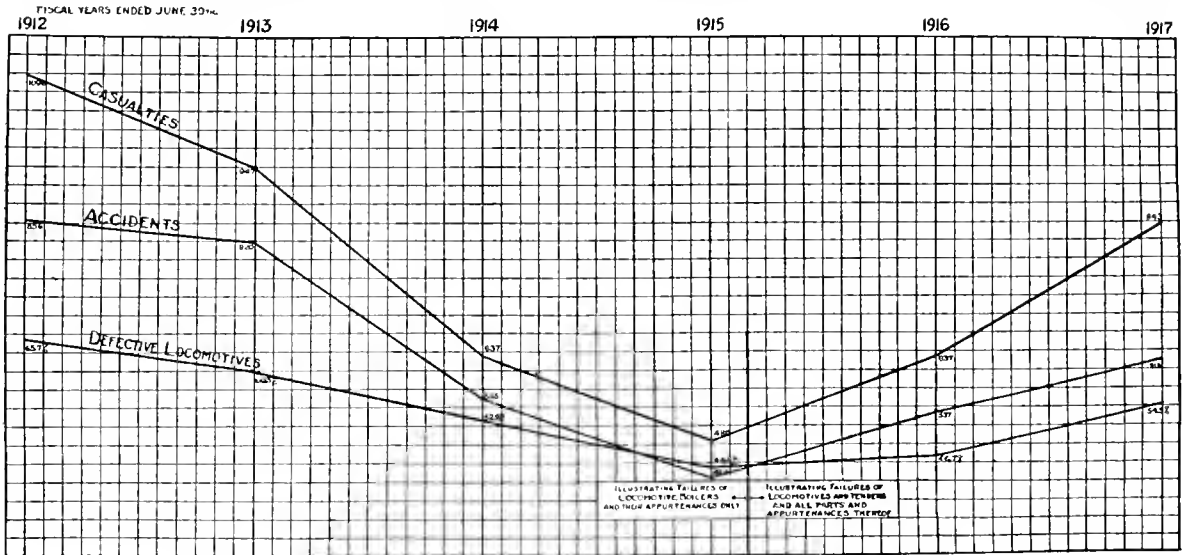

Relation of Defective Locomotives to Accidents and Casualties Resulting from Locomotive Failures

matter of withholding locomotives from service when defective and in violation of the law, under the operating conditions which have existed since the declaration of war and during the months immediately preceding it, have been unusually difficult and have required the most careful consideration. The importance of the prompt, as well as safe, movement of trains has been constantly in mind, and every privilege consistent with the purpose of the law has been

granted after defects, disclosed by our inspections, had been repaired. Thirty-three applications were withdrawn for various reasons. The remaining 477 were granted for the full period asked for. The number of extensions granted this year represents an increase of 16 per cent over those granted during the preceding fiscal year, while the number which were refused shows a decrease of 8 per cent. This indicates that a more thorough inspection is being made by railroad

companies before filing applications for such extensions.

Under rule 54, which requires a specification card containing the results of the calculations made in determining the working pressure and other necessary data to be filed, with the Chief Inspector, for each locomotive operated, and an alteration report or corrected card when any changes are made which affect the data shown, approximately 3,500 specification cards and 9,500 alteration reports were filed. These specification cards and alteration reports are carefully checked to determine whether or not the factor of safety meets the requirements of the rules, and when locomotive boilers are found in service with the factor below that required by the law, action is taken as provided therein. The importance of carefully checking specification cards and alteration reports is demonstrated by the fact that serious errors have been found in hundreds of them. In some instances locomotives have been found in service with steam pressure greater than the boilers were originally designed to carry. In a number of instances alteration reports have been filed showing patches applied in a manner which materially decreased the strength of the boiler. Investigation developed the fact that some companies did not calculate the stress on the boiler when the repairs were made and that others had improperly calculated such stresses.

In order to prevent this, we have recommended: first, that the strength of patches should be determined by a competent



Steam Leaks Due to a Cracked Cylinder Found by the Government Inspectors

person before they are applied; second, that the patch plate be the same thickness as the shell plate to which it is applied; and third, the efficiency of patch seams should equal corresponding seams in the boiler as originally designed.

Six hundred and sixteen accidents caused by failure of locomotives or tenders or some part or appurtenance thereof, including the boiler, have been investigated in the past year.

Accident investigation is only of value when the knowledge gained thereby is used to prevent similar accidents. The result of a single investigation may not be sufficiently conclusive to base a change in methods or equipment thereon, but where investigations cover numerous accidents extending over a period of years, changes can be recommended which can reasonably be expected to be of substantial value in preventing accidents of a similar character.

The similarity of the effect of accidents of certain types clearly points to improvements in construction or in methods which will promote safety in the operation of locomotives.

The advisability of recommending additional rules at this time has been given careful consideration, with a view to avoiding, as far as consistent with the purpose of the law, regulations which would require additional equipment or labor during the war, except where it has been demonstrated that both safety and efficiency will be increased thereby.

In accordance with the above the following recommendations with the reasons therefor are made:

First.—New locomotives placed in service should have a mechanically operated fire door, so constructed that it may be operated by pressure of the foot on a pedal or push button, or other suitable appliance, located in the deck or floor of the cab or tender at a suitable distance from the fire door, so that it may be conveniently operated by the fireman from his position while engaged in firing such locomotive. Locomotives now in service should be equipped with a mechanically operated fire door, as above described, the first time they are shopped for general or heavy repairs, and all locomotives should be so equipped within a reasonable time; provided, that the above recommendation should not apply to locomotives equipped with mechanical stokers not to locomotives using oil for fuel.

Second.—Air operated power reversing gear should also have a steam connection, with an operating valve conveniently located in the cab, and so arranged that in case of air failure steam may be quickly used to operate the reversing gear.

Third.—Holes for plugs or studs in boiler sheets should have a good thread the full thickness of the sheet in which they are applied, and all plugs and studs and other fittings should be screwed through the sheet. Plugs, studs, or other boiler fittings should not be repaired by calking, and under no circumstances should an attempt be made to tighten them while there is steam pressure on the boiler.

The first recommendation is based on the result of hundreds of investigations of boiler failures of a character which permits the steam and water contained in the boiler to be discharged into the fire box. With the swing type door, which is at present largely used, such a failure invariably results in blowing the fire door open and discharging steam and boiling water, together with the contents of the fire box, into the cab of the locomotive, seriously or fatally burning persons therein. The automatic fire door will remain closed if the failure occurs while it is closed; and if the failure occurs while it is open, it will automatically close the instant the fireman's foot is removed from the operating device, thus preventing the direct discharge of steam and scalding water into the cab of the locomotive.

The second recommendation is made because defects to certain types of brake equipment, which results in the loss of main reservoir pressure, not only renders the brake inoperative, but renders the air operated reversing gear also inoperative. When this occurs on a locomotive being operated light, it results in the complete loss of control of the locomotive; and instances where this has occurred, resulting in serious accidents, have been investigated by this bureau. In one case where such steam connection had been provided it was found that it had been obstructed by placing blind gaskets in it, because it was claimed that the steam damaged the packing in the reversing cylinder. Such practices should be prohibited, and the steam connection applied and maintained so that it can be quickly used at all times.

The third recommendation is based on an investigation of more than 200 accidents, due to plugs, studs, or other boiler fittings blowing out. In a large percentage of the cases it was due to improper application, as the plug, stud, or fitting had only been screwed part way through the sheet, while in some cases not more than two or three threads were holding in the sheet.

No formal appeal from the decision of any inspector has been filed during the year.

The accompanying chart shows the relation between the percentage of locomotives found defective and the number of accidents and casualties resulting from failure thereof and illustrates the result of operating defective locomotives. It does not accurately represent the result of the law, because prior to September 4, 1915, the law only applied to locomotive boilers and their appurtenances, while since that date it includes the entire locomotive and tender and all their parts and appurtenances; therefore, the increase in the percentage of locomotives found defective, also in the accidents and casualties since that date is largely due to the extension of the law to include the entire locomotive and tender.

It should be noted that the record of accidents and casualties at the close of the fiscal year ended June 30, 1917, is well below the record for 1912, although the record for 1917 includes 227 accidents and 262 casualties, due to failure of parts of the locomotive and tender which were not covered by the original boiler inspection law.



DELAWARE & HUDSON STEEL UNDER-FRAME FOR WOOD FREIGHT CARS

In rebuilding and repairing cars of 60,000 lb. capacity of the box and single-hopper bottom type, and also for tandem hopper cars of 85,000 lb. capacity, the Delaware & Hudson is applying the steel underframe shown in the accompanying illustration.

For the box cars, the underframe of which is shown in the drawing, the steel portion consists of the center sills and the body bolsters. The wooden end and side sills are retained and the latter are trussed in the usual manner. The steel portion of the underframing includes the center sills, body bolster and cross bearers for carrying the side sills. The center sills are formed of 12 in. channels. On top of these channels there is a cover plate $\frac{1}{4}$ in. thick extending from end

bearers are of the same design except that but one section is used instead of two; this being stiffened with a cover plate at the top and bottom.

The underframe used for the hopper coal cars is of the same general design. The details are similar but are of necessity somewhat differently arranged and 15-in. channels are used instead of 12-in. channels for the center sills.

HOT BOXES*

BY H. L. SHIPMAN

Equipment Inspector, Atchison, Topeka & Santa Fe

The question of hot boxes is so common and has been discussed so frequently that some of the fundamental principles are overlooked. One of the chief of these is the brass not fitting the journal when it is applied. Very few journal

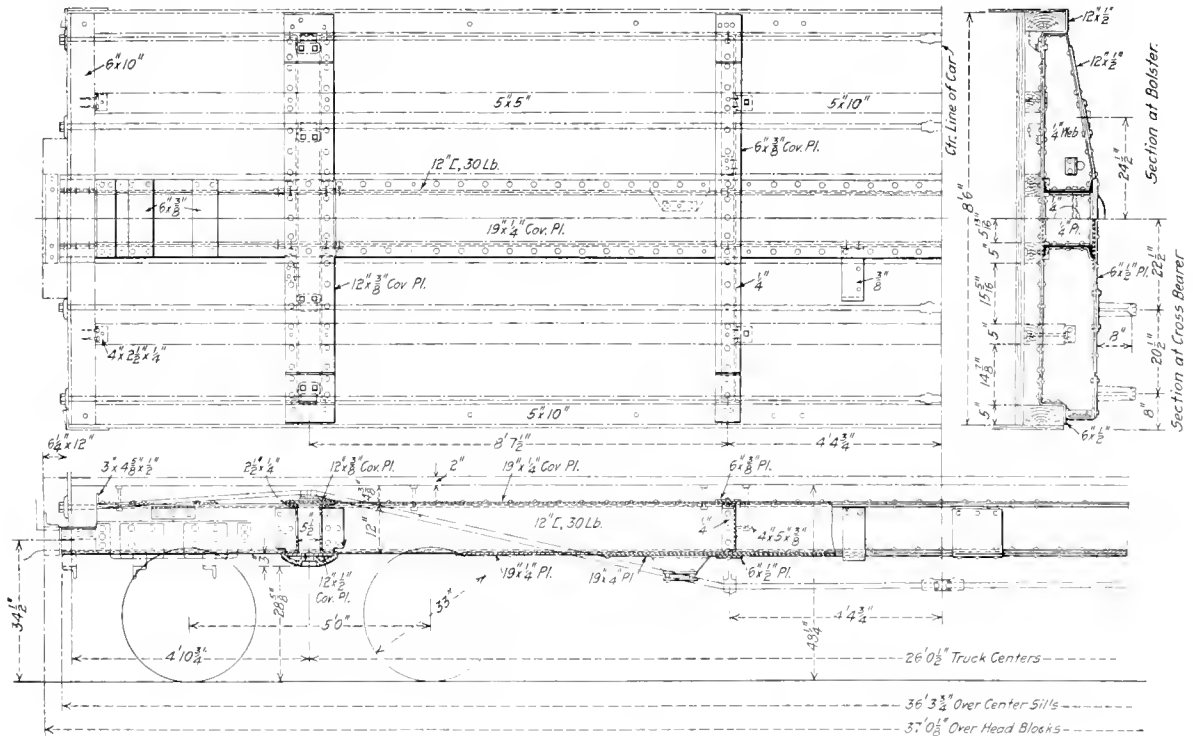

Steel Reinforcement for 60,000 lb. Capacity Wood Box Cars

to end of the center sill, and an additional plate of the same thickness running from cross bearer to cross bearer. There is also a $\frac{3}{8}$ -in. cover plate riveted to the bottom flanges of the channels which is 19 ft. 3 in. long.

The bolsters are pressed steel of U section and are held together by cover plates at the top and bottom. The cross

bearings have 50 per cent bearing area when applied, and most of them do not have 30 per cent bearing area. The belief that the brass will come to a good bearing in a hundred miles, is not true.

The weight of the load will not crush the babbitt lining

*From a paper presented before the Car Foremen's Association of Chicago

until it becomes hot. A journal is supposed to carry a load of from 350 to 400 lb. per square in. on the projected area of the brass. If this pressure is multiplied by three or four, there is then a pressure of from 1,000 to 1,500 lb. per square inch. This pressure will generate more heat than the brass is able to conduct away, especially if a little grit or dirt is present in the packing; consequently, the temperature of the bearing will rise until the conditions change. Usually the temperature will rise until the babbitt becomes soft enough to crush under the weight of the load. As soon as the bearing area spreads, the pressure per square inch is reduced and the brass cools.

The melting temperature of the solder that holds the lining in the brass is about 350 deg. F., which is 75 deg. F. less than the melting temperature of the lining. Therefore, it often happens that the solder melts and is squeezed out from between the lining and the brass, before the lining becomes soft enough to crush under the weight of the load. When this occurs the crown of the lining is left loose in the brass. After the lining has become loose it is cracked by the shocks of switching and rough handling, or by brake applications. Brake applications under certain conditions will crack the lining after it is loose but will not break the brass itself.

A journal bearing with a loose lining, under favorable conditions, may run for months after the original damage is done before it will give any more trouble. As soon as the lining begins to shell out, however, the bearing should be removed. When the lining gives away in spots, the pressure is concentrated at the other points of contact, raising it above a safe pressure for a bearing and consequently increasing the liability to heat.

Another condition that is generally overlooked, is that the lining of a brass that has been in service a year or so, gradually becomes filled with grit and sand. These fine particles become embedded in the babbitt and increase the normal running temperature of the bearing above what it would be, were the particles of grit not present. It has been found difficult to rebore the lining of these old bearings, on account of dulling the cutting edge of high speed steel, because grit and sand are embedded in the babbitt.

Dirt and sand cannot embed themselves in the brass, therefore, to avoid trouble, a brass should be removed as soon as the babbitt is worn out. Where the box lids were tight and good dust guards in place, there have been cases of bearings that ran cool on the brass, after the lining had worn out. Dust guards and box lids must be maintained in order to keep out the grit and dirt. Sand may not cause a hot box, but it increases the liability of heating.

The next point is the matter of "preparedness." It should always be our endeavor to have the journal boxes in condition to run, before the trip is begun and not wait until trouble occurs. This will necessitate a little extra work at the starting terminal, but will make less work on the road and less at the next terminal, thereby making a saving. It is a question of whether the work is to be done on the road or on the repair track. It must be done somewhere, and the repair track is the proper place to do it. Every time there is a hot box two pounds of waste and over a gallon of oil are burned up, which at present amounts to about 60 cents per hot box. To this should be added the cost of the brasses, delays, cut journal, wrecks, etc.

Recently a case has been called to my attention, where a 70 ft. steel underframe coach was run over 35,000 miles without either re-oiling or repacking. Why do we oil passenger cars every 1,000 or 1,500 miles when it has been shown that a record like this can be made by skillful handling? The only answer is lack of preparation and attention.

To obtain the best results in reducing hot box trouble, it is necessary to adopt some system of inspection to insure that the packing will be pulled and the brass examined at

regular intervals. The most important feature of this whole subject is to teach the employees how to care for journal bearings so as to prevent trouble, and second, how to determine the cause of a hot box after it has occurred. The car men very seldom see a hot box until it is burnt up. The train men generally report "dry packing," and do not stop to consider that the smoke by which they detect the hot box is vaporized oil. They should not expect to find the oil in the box after it has passed off as smoke. The trainmen should endeavor to determine the cause for a hot box and not just report dry packing. If they could give the real cause, then the car man would know where he is "falling down." We must have more cooperation between these two classes of employees to obtain the best results.

In order to enable the men to classify the different causes of journal bearings running hot, they have been divided into two general classes: First, hot bearings that run cool after they have been repacked; second, hot bearings that continue to run hot after they have been re-packed. The causes are listed in the order of their importance as follows:

UNDER FIRST HEADING.

- a. Packing not in contact with the journal.
- b. Packing caked or glazed.
- c. Oil washed out of the box by the use of water.
- d. Insufficient packing in the box.
- e. Box packed too tightly.
- f. Presence of abrasive or cutting particles in the waste.
- g. Packing dry.

UNDER SECOND HEADING.

- a. Thread of waste under the brass.
- b. Defective, broken or worn out brass.
- c. Concentrated pressure due to improper fit of the brass.
- d. Brass not the proper size for the journal.
- e. Cut or seamy journal.
- f. Bent journal or axle.
- g. A "wiper" on the brass.
- h. Tapered journal, causing irregular pressure on the brass.
- i. Truck out of square.
- j. Truck side frames out of line.
- k. Crown of wedge not having the proper bearing in the box.
- l. Brass not fitting the wedge.
- m. Unequal distribution of the load.
- n. Overloaded.

This subdivision has been made to enable a trainman to arrive at the true cause of a hot box with a greater degree of accuracy. It is our desire to prevent every hot box, but when one does occur we want to know the actual cause; then we may be able to prevent the next one. Hot box trouble can be conquered by two things only: education and preparedness.

A list of questions and answers has been prepared so as to enlighten our men on this subject and cause them to think for themselves. Our endeavor is to interest the men doing this work so as to cause them to think of what they are doing and why they do it. These questions and answers cover not only how a box should be packed, but why a box runs hot, when it should be repacked and when rebrassed.

Two prominent eastern roads are trying out a new method of packing a journal box. This is similar to the old method except that no waste is put in the outside end of the box. They claim a saving of about 14 per cent for waste and oil. This method of packing is only in the experimental stage, and should be thoroughly tested out before it is generally adopted. Whatever method of packing is adopted, the number of hot boxes will always be measured by the degree of interest and cooperation we can attain between our shop men, yard men, and train men.

DISCUSSION

The difficulty of educating employees with the large number of changes which now take place in the forces makes systematic training essential. Repacking freight cars regularly each year has given good results in eliminating hot boxes. Several members expressed the opinion that the lubrication of cars would receive more attention if there was an M. C. B. charge for the work. The record of one road showed that 10 per cent of the packing removed from freight cars was not fit to be used. Experience with clasp brakes on European roads has demonstrated that they reduce the troubles from hot boxes.

REFRIGERATOR CARS FOR THE B. & O.

Insulation Applied Without Intervening Air Spaces; Unobstructed Circulation of Air Around the Ice

THE Baltimore & Ohio has recently constructed in its own shops some refrigerator cars that contain many interesting and new features in their design. Contrary to the customary practice, the insulation throughout the car is applied without any air space between the different layers. The purpose of this arrangement is to eliminate the so-called dead air space and to better support the insulation. It has been found that it is difficult to maintain a tight car with the layers of insulation separated, on account of the constant weaving of the car, and, further, that the only *real* dead air space is in the insulation itself. By applying the various layers of the insulation directly on themselves, the construction of the car is less complicated and the insulation can be better supported, and it will not deteriorate as rapidly.

A careful study of refrigerator car design has also shown

and weigh 54,800 pounds. They have the following general dimensions:

Length inside	30 ft. 85 $\frac{1}{2}$ in.
Length between ice boxes	33 ft. 7 $\frac{1}{2}$ in.
Length of outside over body	40 ft. 10 $\frac{1}{2}$ in.
Width over sills	9 ft. 3 $\frac{1}{4}$ in.
Width inside	8 ft. 3 $\frac{1}{2}$ in.
Width at eaves	9 ft. 5 $\frac{1}{2}$ in.
Maximum width over side ladders	9 ft. 9 $\frac{1}{2}$ in.
Height inside, floor to ceiling	7 ft. 6 in.
Height from rail to top of brake shaft	13 ft. 10 $\frac{1}{2}$ in.
Distance from center to center of trucks	31 ft. 8 $\frac{1}{4}$ in.
Wheel base of truck	5 ft. 4 in.
Size of journals	5 in. by 9 in.
Height from rail to top of floor	4 ft. 13 in.
Width of side door opening	4 ft. 0 in.
Length over end sill channels	41 ft. 11 $\frac{1}{2}$ in.
Length over striking casting	42 ft. 8 $\frac{1}{4}$ in.

CAR FRAMING

The underframe was furnished by the Ralston Steel Car Company. It is made entirely of steel, consisting of pressed

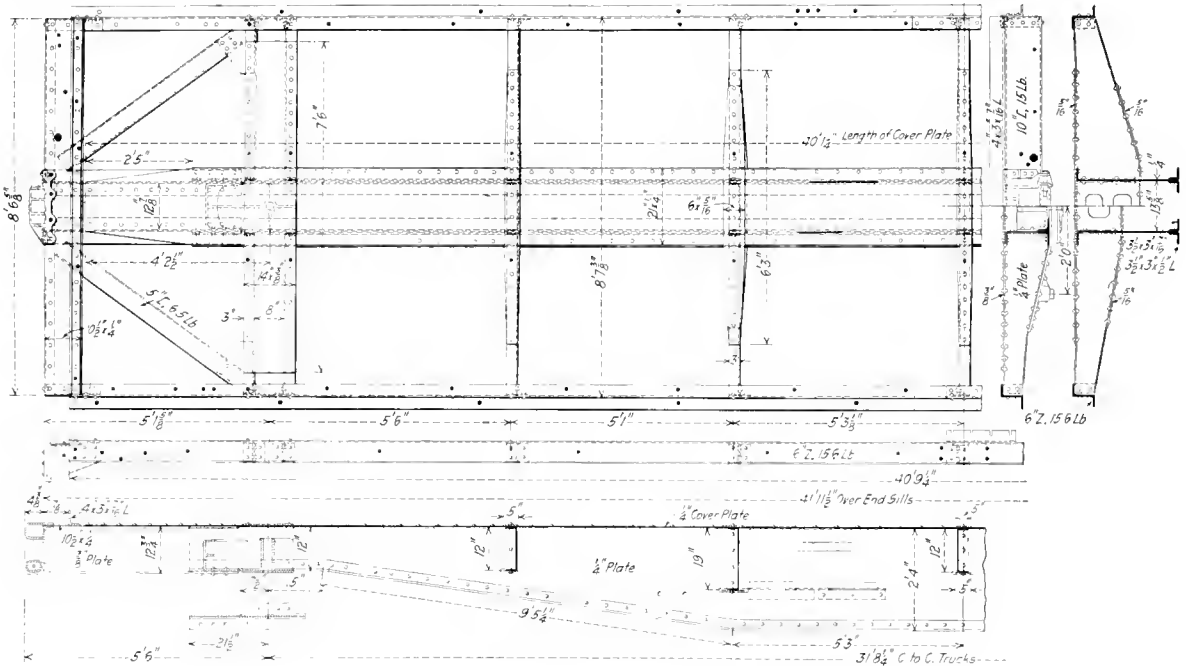

Steel Underframe for the Baltimore & Ohio Refrigerator Cars

that the lading of the car will be better refrigerated if the air in the car has a direct and positive circulation. To obtain this the bulkhead of the ice chamber was made solid, with ample openings at the top and bottom, and the load is held above the floor on racks. To obtain greater effectiveness from the ice, a wire netting is provided to hold the ice, which permits a free circulation of the air around it. With the ice thus held away from the sides and end of the car, less heat is transmitted through the car walls. The bulkhead is insulated, so that it, too, will not transmit heat to the ice, but instead guide the cold air down to the bottom of the car for circulation. The insulated bulkhead is of further benefit in that it prevents to a large extent the condensation of moisture on the car side of the bulkhead, which is liable to spoil the material placed against it.

These refrigerator cars are of 70,000 pounds capacity

and rolled shapes. The center sill is a fish-belly girder 2 ft. 4 in. deep at the center and 12 $\frac{3}{4}$ in. deep at the ends. The webs are of $\frac{1}{4}$ in. plate flanged outward at the top to receive the coverplate. They extend a short distance back of the body bolsters, where they are riveted to the $\frac{3}{8}$ -in. draft sills. The coverplate is 21 in. wide by $\frac{1}{4}$ in. thick and extends between the end sills. The bottom of the center sill webs are reinforced by 3 $\frac{1}{2}$ -in. by 3-in. by $\frac{1}{2}$ -in. angles on the outside and 3 $\frac{1}{2}$ -in. by 3-in. by 7 $\frac{1}{16}$ -in. angles on the inside. The body bolsters are $\frac{1}{4}$ -in. pressed steel pans shaped to fit into the center and side sills. They have 14-in. by 3 $\frac{3}{8}$ -in. top coverplates and 14-in. by $\frac{1}{2}$ -in. bottom coverplates. The cross-bearers are $\frac{1}{4}$ -in. pressed steel pans with 5/16-in. top and bottom coverplates. The side bearings are located on 48-in. centers.

The end sills are 10-in., 15-lb. channels, reinforced at the

top by 4-in. by 3-in. by 7 10-in. angles set $7\frac{1}{8}$ in. back of the face of the channels. The end sills are braced at the center by 5-in., 6.5-lb. channels extending back to the ends of the body bolsters. The side sills are 6-in., 15 6-lb. Z-bars.

The side posts and braces are 5-in. by 2-in. Oregon fir, being set into malleable iron pockets doweled into the side and end framing. A tie rod is located at each post, extending through the side plate and side sill. The carlines are white oak, $1\frac{3}{4}$ in. thick. The ridge pole is secured to alternate carlines by $1\frac{1}{4}$ -in. pressed knees bolted to both the carlines and the ridge pole. The flooring, lining, sheathing and ceiling is Oregon fir. The flooring is $1\frac{3}{4}$ in. thick, and the lining, sheathing and the ceiling are $1\frac{3}{16}$ in. thick. The roofing boards are of the same material and are covered with the Murphy XLA outside metal roof. The end plates are 3 in. by 9 in., and the side plates are 3 in. by 8 in.

INSULATION

The method of insulating these cars, as stated above, is novel in contrast to the general practice followed. No attempt has been made to provide dead-air space between the successive layers of insulation, and greater care has been taken in its application.

The cross sections show that below the $1\frac{3}{4}$ -in. flooring there is a 1-in. air space with 1-in. by 1-in. floor strips. A layer of felt paper is applied on top of two thicknesses of

The $1\frac{3}{4}$ -in. flooring is supported on 3-in. by 3-in. nailing strips, which are bolted directly to the subfloor and the cross-bearers of the underframe. The felt paper extends in one

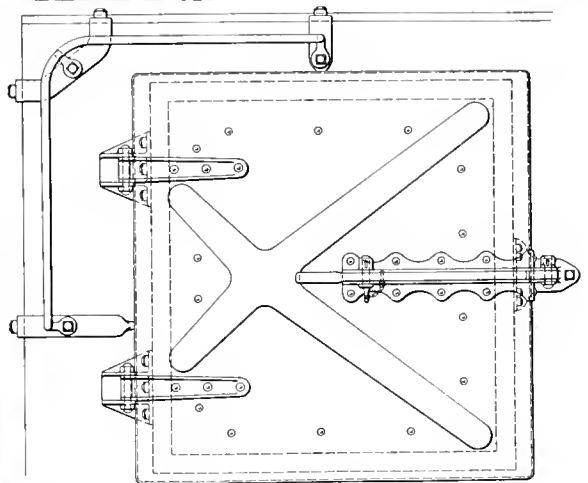
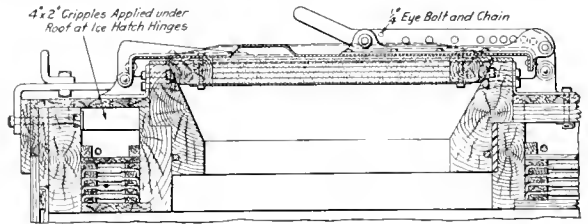

The Ice Hatch Door

piece from side to side of the car, the ends extending up between the corkboard insulation on the sides.

The lower part of the siding is insulated with four layers

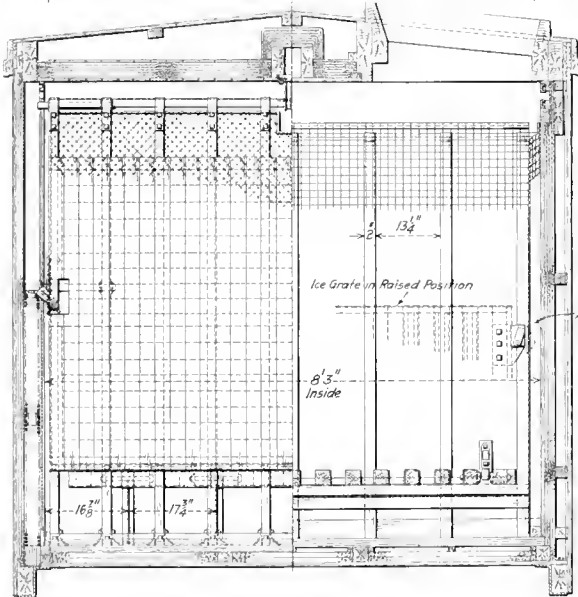
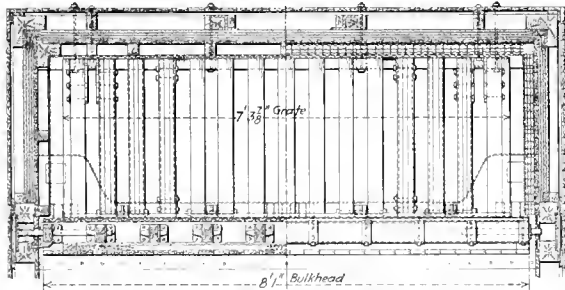

Sections Through the Ice Bunkers, Showing the Insulated Bulkhead

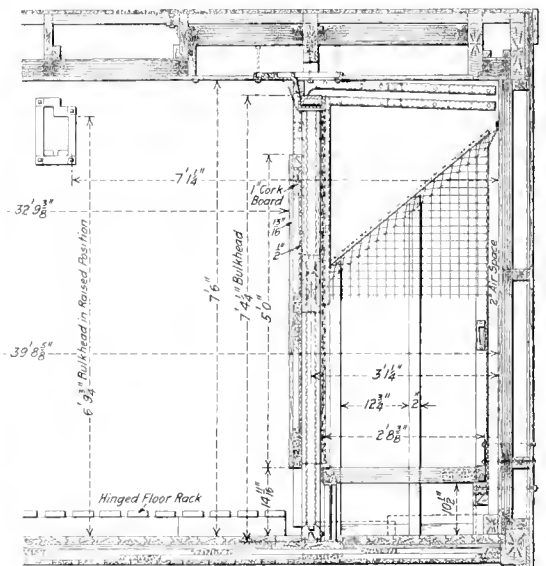

1-in. corkboard. Before the felt paper is applied the top surface of the corkboard is coated with hot odorless asphaltum to tightly seal all joints. Beneath the two 1-inch thicknesses of corkboard there is a $1\frac{3}{16}$ -in. subfloor.

of $\frac{1}{2}$ -in. corkboard. The inside lining is beveled at the bottom and caulked to prevent water on the inside of the car seeping through into the insulation, causing its deterioration. The felt paper extends throughout the entire side of

the car between the inside lining and the insulation. Above the corkboard there are four layers of 1/2-in. hair-felt, covered with asphaltum insulating paper, laid directly on each other with no air space between them. They are held at the belt rails by 3/8-in. by 2-in. furring strips, as shown in the illustrations. The insulation passes around the corners of the car in continuous pieces to better provide a tight insulated

by nails, therefore, 3/4-in. by 3-in. ceiling support strips are placed at every third carline and are bolted to the carlines by 3/8-in. bolts countersunk into the carlines.

ICE BOXES

The ice boxes are of particular interest, being so constructed that a 2-in. air space completely surrounds the ice.

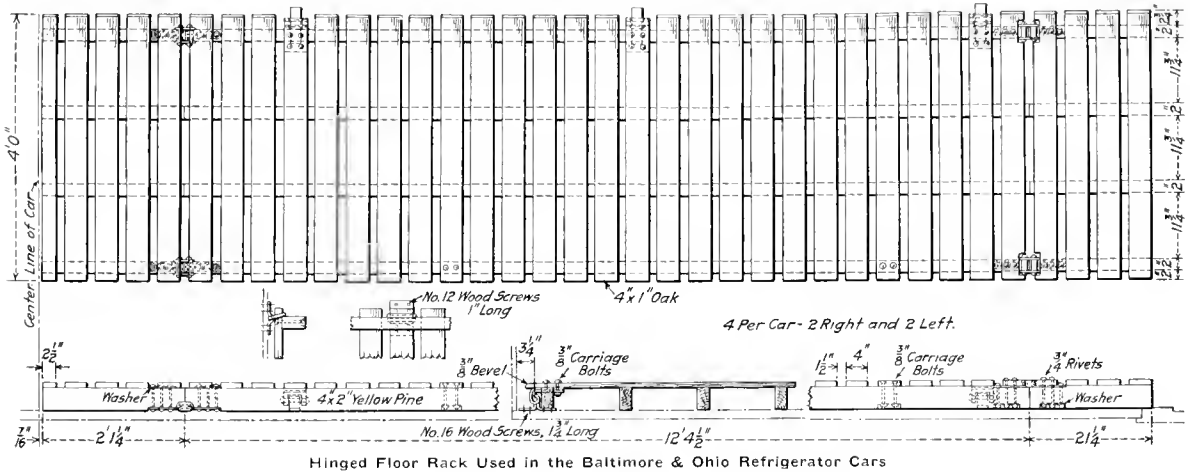

joint. At the top the outside layer of insulation is lapped up into the ceiling insulation around the side plate. The insulation in the ceiling is heavier than that on the sides, as it has been found that the absorption of heat is greater on top of the car than on the sides. Six layers of

The ice is contained in a heavy wire netting, which exposes the ice to the air circulating through the car. The ice boxes are provided with a Bohn insulated collapsible bulkhead, which is 7 ft. 4 1/4 in. high, having an opening at the top and bottom for the circulation of air through the ice box. The

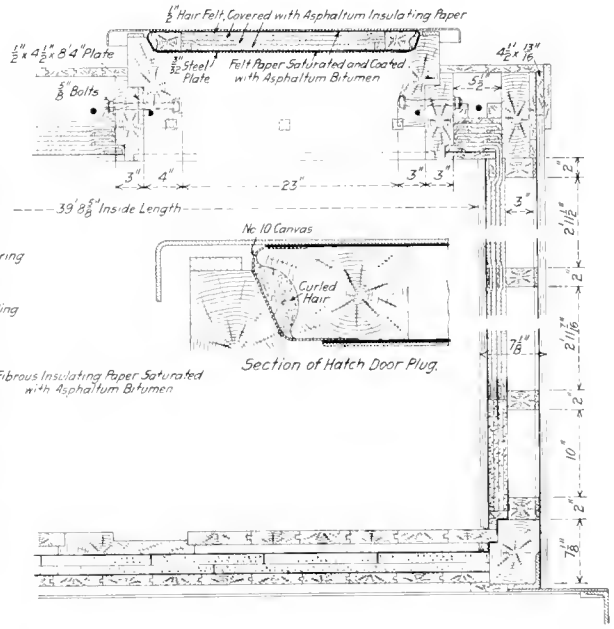
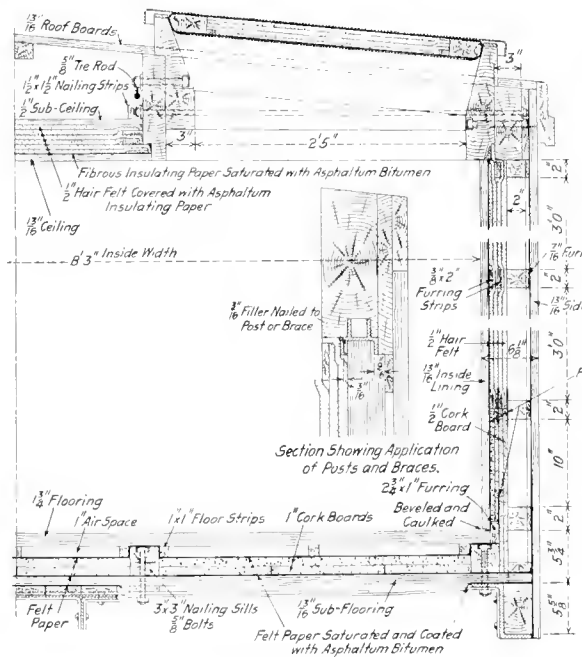

Sections Through the Ice Hatch Showing the Insulation on the Sides, Ends and Floor of the Car

1/2-in. hair-felt are used here. These are placed directly on top of the 13/16-in. ceiling without any air spaces between them. On top of the insulation is placed a 1/2-in. subceiling which is nailed to the carlines. The weight of the ceiling with the insulation is too great for it to be substantially held

insulated portion of the bulkhead is 5 ft. in height, and this consists of a 13/16-in. lining, a 1-in. layer of corkboard and a 1/2-in. lining.

The purpose of insulating the bulkhead is to insure that the ice bunker will not cool the perishable freight piled up

against it to a lower degree of temperature than obtains in other parts of the car. This feature is an exceptionally important one, as bananas and other fruit, as well as eggs, have been known to freeze when piled up against the bulkhead of ice bunkers that were not insulated. The insulated bulkhead also effects a more positive circulation through the car.

The wire netting which holds the ice is cut away at the top to allow swinging the collapsible bulkhead into place at the top of the car. Without this type of bulkhead the netting would ordinarily be extended up to the top of the ice box.

To further assist in the positive circulation of the air, a floor rack made up of 1-in. by 4-in. boards, spaced 1½ in. apart, is hinged to the sides of the car, and when in the lowered position it is 4 in. above the floor of the car. This allows the cold air to work up through the load equally throughout all parts of the car and better refrigerates the material carried.

Considerable care has been taken to properly insulate the walls surrounding the ice box. The illustration shows how thoroughly this has been done. The runway for the collapsible bulkhead at the center of the car is insulated by six layers of insulation which extend around it. The spaces between this runway and the hatchway, and between the hatchway and the end of the car are also as thoroughly protected.

The ice hatch and door are particularly well constructed. A ½-in. plate 4½ in. by 8 ft. 4 in. extends across the car in the hatch frame at the inner side to give it strength. In

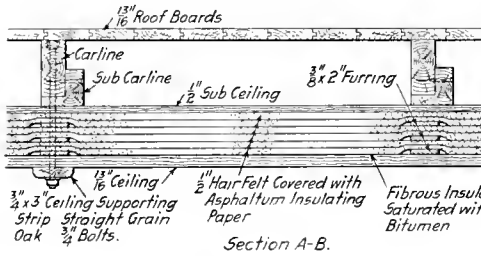

Method of Applying the Insulation to the Roof and Corners of the B. & O. Refrigerator Cars

addition to this a bar ¾ in. thick by 1½ in. wide extends around the top of the hatch frame for reinforcement. The hatch door is made with a ¾, 32-in. steel plate on the underside and a ¼-in. pressed steel plate on top, which are bolted to the door frame by ¾-in. carriage bolts. The upper plate is ribbed to give it additional strength and is flanged downward on all four edges to protect the joints from rain. Between the steel plates four layers of ½-in. hairfelt with felt paper above and below are applied for insulation. The lock bar is so designed that the hatch door must be tightly closed before the door can be locked. A series of holes are provided in the lock bar to mesh with a hole in a bracket attached to the top coverplate of the door, to permit holding the hatch door open at desired heights when the car is used in ventilator service.

These cars are equipped with the Westinghouse type K brakes. The trucks used were taken from dismantled steel hopper cars and have 5-in. by 9-in. journals. The capacity of the trucks is 80,000 lb. The ice bunkers have a capacity of 15,000 lb. of ice.

INCREASED COAL PRODUCTION IN FRANCE.—The monthly production of coal in France has increased from 1,576,062 tons in June, 1916, to 2,345,251 tons in June, 1917, the output of the French coal mines having increased almost steadily during the intervening period.

EMERGENCY AIR AND SIGNAL HOSE COUPLING

Practically all engineers are aware that in case of a break in the train line in the forward part of a passenger train the brakes on the cars behind can be operated by passing air through the signal pipe of the car on which the break

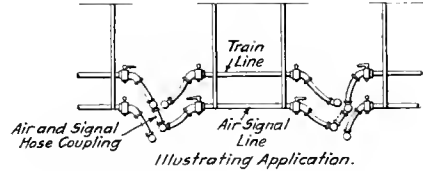
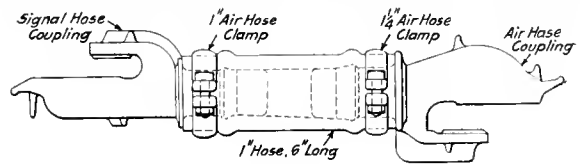

Emergency Coupling and Method of Application

has occurred. Nevertheless, when such failures take place, much time is usually lost as it is not always easy to find the proper fittings for making the change. To avoid such difficulties the Illinois Central provides that each baggage car

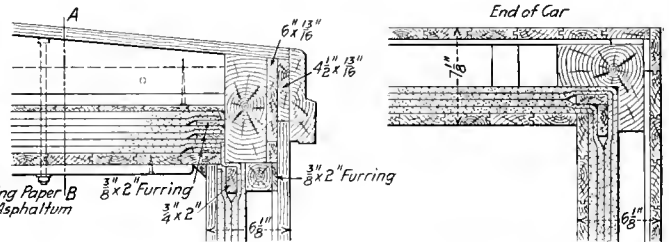

shall carry two special couplings for connecting the air signal pipe of one car and the train pipe of the adjoining car.

These consist of signal hose coupling and an air hose coupling attached to a piece of 1-in. air hose 6 in. long. With these couplings it is only necessary to uncouple the train line and signal line at the end of the damaged car and connect the signal line with the train line on the adjacent cars. The method of application as well as the construction of the coupling is shown in the illustration.

EFFECT OF LABOR TROUBLE ON COAL PRODUCTION.—According to a statement authorized by the Geological Survey, Department of the Interior, a direct measure of the serious effect of labor trouble is furnished by the statistics of bituminous coal production for the week ended August 18. In this week, by reason of strikes in Illinois and the Southern Appalachians, the ratio of tonnage produced to full-time capacity, as limited by present labor supply, was lowered for the country from 71.8 per cent to 62.5 per cent. In the districts directly affected the reductions were in Illinois from 70.3 per cent to 54.8 per cent and in eastern Kentucky and Tennessee from 74.2 to 10.8. Conditions in Iowa, Indiana and Ohio improved slightly, and the output percentage in western Pennsylvania declined from 78.2 to 69.4.

MODERN DRAFT GEAR REQUIREMENTS*

Advantages of a 4-in. Travel for High Capacity Gears Discussed; Methods of Testing Described

BY L. E. ENDSLEY

Professor, Railway Mechanical Engineering, University of Pittsburgh

DRRAFT gears have been much discussed by the railway people for a great many years, and there are many phases of this subject. There are three things that draft gears may do in the handling of railway cars. These may be divided in general as follows:

1. Produce slack in starting trains.
2. Control slack in the movement of trains.
3. Reduce the impact force in the switching of cars.

In all of these the principle involved is the same, namely, producing the same speed in two cars that may be coming together or going apart because of differences of speed. The draft gear to be effective in doing this, must have a capacity that is relative to the difference in speed. What I mean by this is that for a difference of speed of, say, one mile per hour, a draft gear of small capacity will suffice, but if the difference in speed is 4 m.p.h., it will take a draft gear 16 times as large to prevent a shock, for the energy of a moving body is proportional to the square of its velocity.

Draft gear capacity is the number of foot-pounds of work required to just close the draft gear. It can be represented by an area, as shown in Fig. 1. The lower line of this chart represents the travel of the draft gear and the upper distance represents the force exerted on the coupler to close

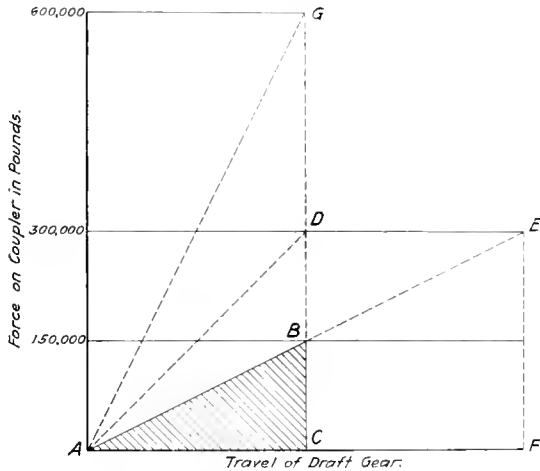

Fig. 1—Graphic Representation of Draft Gear Capacity

the draft gear. If we assume a draft gear with a travel of 2 in., or from *A* to *C* in this figure, a final pressure of 150,000 lb., or from *C* to *B*, and that the pressure necessary to close the gear under discussion was directly proportional to the movement; the line of action of the gear would be a straight line and would be represented by *AB*. The capacity of the gear then would be represented by area *ABC*. Now, if we wish to increase the capacity without increasing the slope of the line *AB*, we must increase the travel, and if we should increase the travel to double that shown in the shaded area, we would have four times as much capacity as we had before. That is, if *AC* equal half of *AF*, the area *ABC* is one-fourth of *AEF*. While if we wish

to increase the capacity of the gear and not the travel, we will have to increase the slope of the line *AB* to *AD*, in order to keep this pressure 300,000 lb. or below, and will only get an area represented by *ADC*, which is only twice that of *ABC*. The slope of line *AD* is much greater than line *AB*, and should it be desired to get four times as much area as that in *ABC* and still have the same travel, it will be necessary to increase the pressure to 600,000 lb., and then the area of *AGC* will be four times *ABC*, or area *AGC* will equal *AEF*, and the capacity of these two gears will be the same. The two-inch travel gear will have twice the final force that the one with the four-inch travel will have. This final force is what a great many people have called the capacity of a draft gear. The comparison shown in Fig. 1 is ideal. It would be almost impossible to construct a draft gear that has a slope equal to line *AG*. But this figure was merely given to illustrate the advantage of gears having long travel.

If we have a draft gear that has a capacity equal to one-fourth the difference of the energy of two cars in impact, the cars will not receive a shock above the maximum force necessary to close the gear. That is, if a car is going 4 m.p.h. and strikes a car standing still, it will produce in the standing car approximately half of the speed of the moving car, or in other words, put into the standing car one-fourth of the energy that was originally in the rolling car. The rolling car will retain approximately one-fourth and coast down with the second car, but half the energy is gone and it must be absorbed in the draft gear or some part of the underframe. Of course, some of this energy may be absorbed, due to the shifting of the load, but it must be destroyed in some manner. If it is not done in the draft gear, it is bound to be done on the underframe or the coupler.

This shifting of the load amounts to considerable in some kinds of freight, such as coal and ore. Now, if the load should shift one inch, this would be equal to increasing the draft gear travel one inch; also, any give in the underframe would be equal to increasing the travel of the draft gear. Now there is considerable difference in the give of cars. Steel cars only give half as much as wooden cars below the elastic limit, assuming that both have the same ultimate strength. This fact is one thing that has been entering into wooden car construction. There has been considerable give in the bolt holes between the draft timbers and sills. Thus

TABLE I
Comparison of a Car, Total Weight 150,000 Pounds

Speed in miles per hour	Approximate energy in foot-pounds	Capacity of gear in foot-pounds to just close	Approximate height of drop of 9,000 hammer to shear nine 19/32 rivets
1	5,900	1,250	4.7 in.
2	24,000	5,000	9.7 in.
3	45,000	11,250	18.0 in.
4	80,000	20,000	28.7 in.
5	125,000	31,250	44.7 in.
6	180,000	45,000	63.0 in.

the car itself has been absorbing the shock and there has not been as much need for a draft gear of a large capacity. But when we are now using all steel cars with no give in the rivets, the draft gear must do the work of absorbing the difference in energy between the two cars coming together in impact or the coupler or some other part of the car will have

*Abstract of a paper read before the Canadian Railway Club, November 13, 1917.

to do it; if the coupler is stronger than the other part of the underframe, the underframe will have to do it.

In order to illustrate what energy is necessary to be absorbed for different speeds of cars in switching service Table I is given. The first column of this table gives the speed in miles per hour; the next column gives the foot-pounds of energy in the moving car at the speed given in the first column; the third column gives the capacity of the draft gear that should be used in each car for the speed represented in the first column for two cars weighing loaded, 150,000 lb.; the last column gives the height of drop that the 9,000 lb. hammer should fall before it shears off nine $19/32$ in. rivets to have the capacity given in the third column. This column was obtained by multiplying the values in the third column by 12 and dividing by 9,000 and adding 3. The first part of this deduction is to obtain the height of drop to close the draft gear. The 3 added at the end is the added height in inches that it will take to shear the rivets after the capacity of the draft gear is taken up.

Now, it will be seen that a very small capacity is necessary for one mile per hour, namely, a drop of 4.7 in. of the hammer, but a draft gear that is many times as large is required for a difference in speed of 6 m.p.h., or 63.0 in. This height should be the total fall of the hammer to just touch the dummy coupler used, plus the travel of the draft gear. That is, if the fall of the hammer was 15 in. before it started to close the gear and the travel of the gear was 3 in., the total capacity of the gear would be represented by 18 in. I, personally, think that we should take care of 4 m.p.h. switching speed in the draft gear design. If we should do this, that is, if the draft gear would just close under a speed of 4 m.p.h., it is certain that the coupler or any part of the car would never be damaged in an impact between two cars at this speed.

There is not a coupler on the market but that will stand a greater impact force than the force necessary to close any draft gear on the market today. I have given some heights of drop that a 9,000 lb. hammer should fall before it shears off one or both lugs with 9 rivets $19/32$ in. in diameter. This method of testing draft gears was first used, I think, in September, 1908, at the Westinghouse Airbrake Company, but there $9/16$ in. rivets were used. To my mind, this is the best method of determining the capacity of a draft gear. In this method of testing, the draft gear is mounted on two lugs that are riveted to two short pieces of channels and held upright between posts. Each lug has nine rivets, each $19/32$ in. in diameter, each lug carries half of the load, and the test is made by dropping the 9,000 lb. hammer from 1 in., 2 in., 3 in., and so on, until one lug is sheared off. This occurs at about 275,000 lb., which is the average pressure that I obtained on several sets of lugs.

Now, when the 9,000 lb. hammer drops vertically on a draft gear that is supported on these two lugs that rest on a solid base with these same rivets in the lugs, they will not shear off until an approximate pressure of 275,000 lb. is reached, and in a good many tests with the same draft gear and different sets of lugs, the variation is never more than 1 in. That is, if a given gear shears off at a 16-in. drop, it might go 15 in. at another test, or if it shears off at 24 in. one time, it might go to 25 in. on another set of lugs. In other words, the variation is very small. I have conducted a test of a certain draft gear of a given make that sheared off three sets of lugs at exactly the same height, which means that this method is bound to give very accurate comparison of the capacity of different draft gears.

Up to this point in the paper, I have been talking of draft gear capacity and have not mentioned the absorbing capacity. I wish to distinguish between these two at this point. Draft gear capacity is defined as the foot-pounds of work necessary to close the gear. The absorbing capacity is that which is not given back when the draft gear

is released after being closed. This feature of a draft gear can be very easily obtained from the drop of 9,000-lb. hammer by putting a recording pencil on the hammer and causing it to mark on a revolving drum. If the hammer falls 20 in. and rebounds, say 10 in., it is evident that the absorption has been half the capacity. This feature of the draft gear comes into play in controlling the slack of a long train in going up and down grades and in the starting and stopping of trains. If the slack should run in, and is not absorbed by the draft gear or underframe, it would run out under

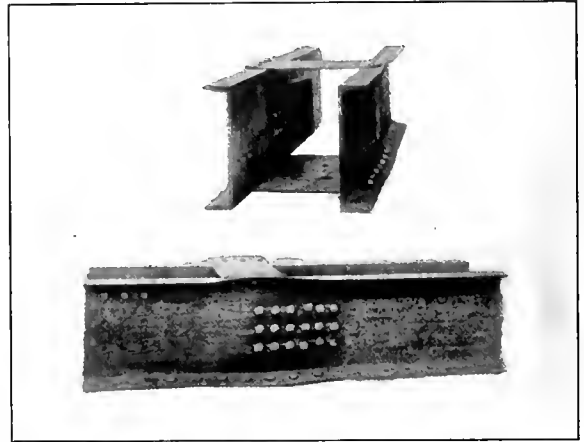

Fig. 2—Deformation of Sills with the Center Line of Draft at the Center

almost the same speed minus only that absorbed in the journal and rail.

This brings me to a point that I have often made, and that is, that we can not expect a draft gear to last the life of the car any more than we can expect a brake-shoe to last the life of the car. No one has, as yet, discovered a metal that has any absorption of work by sliding on some other material that does not wear. Of course, some metals wear more than others under the same absorption. Some years ago I made some tests for the Brake Shoe Committee of the Master Car Builders' Association, and found some shoes with the same coefficient of friction that varied as much as 300 per cent in the loss of weight in doing a given amount of work—and this is a very good subject for study for the draft gear companies. It was found that the loss of metal increases very fast as the pressure increased and the coefficient of friction decreases as the pressure increases. We should keep the pressure between the wearing surfaces of the draft gear as low as possible and this can be done by making it as large as possible.

Some time ago the M. C. B. committee on car construction made some recommendations with regard to the center line of draft. These recommendations when applied to most cars fixed the center line of draft within 2 in. or 3 in. of the center of the sill. In order to get some information on this subject six sets of channels were made up; photographic reproductions of two of them after the tests are shown in Figs. 2 and 3. The channels were each 15 in. high and weighed 40 lb. per ft. The center line of draft of one set was placed on the center of the channel for $7\frac{1}{2}$ in. from the edge and this distance from the edge was decreased by $1\frac{1}{4}$ in. until $2\frac{1}{2}$ in. from the edge was obtained. Two sets of channels with the center line of draft $6\frac{1}{4}$ in. from the edge were made, one set of which did not have any tie plate. The results obtained are given in Table II. It is evident from this table that the center line of draft should be for maximum strength within 2 in. of the center line of the sills, and that

the tie plates are of great value in strengthening the sills. By looking at Fig. 2 it will be seen that when the line of draft is on the center, both upper and lower flanges are bending, while with the line of draft 3 3/4 in. from the edge, as shown in Fig. 3, nearly all of the bending is at a place in the edge of the channel closest to the line of draft. This is nothing extraordinary, for you all know that if you eccen-

TABLE II

Maximum pressure obtained in impact test made on 15-in. 40-lb. channel with 15,000-lb. pendulum hammer, with different center line of draft.

Distance from edge of channel	Maximum pressure obtained before the channel failed
7 1/2 in.	1,155,000 lb.
6 3/4 in.	1,125,000 lb.
5 in.	960,000 lb.
3 3/4 in.	725,000 lb.
2 1/2 in.	602,000 lb.
6 1/4 in. without tie plate	744,000 lb.

trically load any two pieces of steel, the one close to the load is going to take most of the work and the ultimate strength of the system is reduced.

SUMMARY

I have attempted in this paper to bring to your minds two or three very important things in the selection of draft gears and the design of freight cars. One of the most important things is—we will have to increase the travel of the draft gear above that thought sufficient some years ago. Some years ago it was felt that 2 in. or 2 1/4 in. was as much travel as we should have. But I am ready today to say that we should have at least 4 in. of travel, or possibly more, in any draft gear for modern cars. It is evident that this is going to allow us to materially increase the gear capacity.

Another thing of importance to the railway men today is to know what capacity of draft gear they are getting. I am confident that the best method for them to use is the rivet-shearing test, as already described. The number of rivets does not enter into the subject. What they should have is a

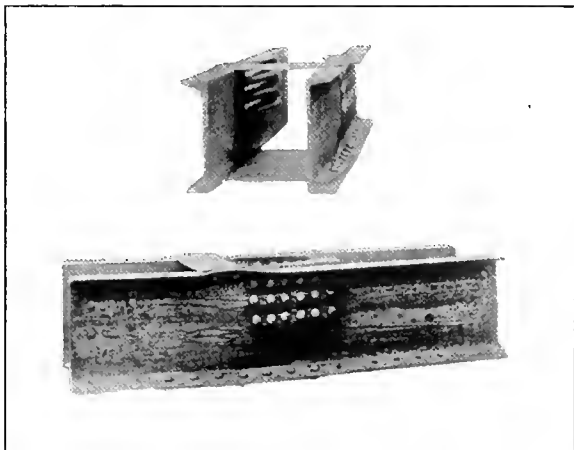

Fig. 3—Deformation of Sills with the Center Line of Draft 3 3/4 in. Down from the Top of the Sills

set of lugs that will shear off just above the force which is necessary to close the gear under test. I can conceive how a gear can be designed for a final pressure of 350,000 lb., then a test of rivets shearing off at 275,000 lb. would not be fair. But in any design of a lug, the lug should be made much stronger than the rivets in order that the lugs will not bend down and the gear show a false capacity. I can see how a lug may be built and give false capacity of draft gear, but the lugs should be designed stronger than the rivets. I myself, have not found a draft gear today but that will close before it shears off nine 19/32 in. rivets.

However, there may be some such gear on the market.

One thing that is important in the design of a freight car is that the underframe of the car should be made stronger than the coupler. It has been the coupler in the past that has been saving the car after the draft gear went solid. The men who repair cars appreciate the large number of couplers that fail. I am wondering if when we put on the new M. C. B. coupler it is not going to be the underframe of the car instead of the coupler that is going to fail when the draft gear goes solid. Especially is this true if we move the center line of draft out from the center of the sills or leave off the tie plate, as shown in the latter part of this paper, because then the pressure of only 662,000 lb. destroys the sills with the center line of draft 2 1/2 in. from the edge of the channel. The new coupler will stand this and more in compression, which means that it will not be the coupler but the underframe that fails, and it will cost considerably more for repairs than the coupler.

I assume that everybody here knows that a friction draft gear is superior to a spring gear, but I do not believe that all of you know how much this difference is. The highest capacity spring gear in use, made of two M. C. B. class G springs, will fully protect your 100,000 lb. car and lading at a switching speed of a little less than 2 m.p.h. There are friction draft gears in general use on thousands of cars that will protect this same car and lading at 4.5 m.p.h. Also, there are many gears on the market that will fall between these two extremes, and each of these gears has a definite speed at which it will protect the car. But if you should attempt to switch cars at 4 m.p.h. while equipped with a spring draft gear that only protects the car at a little less than 2 m.p.h., the coupler, underframe and lading are bound to suffer. Either the coupler or underframe will fail if this speed of switching is kept up. On the other hand, should this same car be equipped with the highest capacity gear, mentioned above, it could be switched at 4 m.p.h. without any damage to the underframe or to the coupler.

Unless we put on a car a draft gear of sufficient capacity to keep it from going solid, the force that car will stand is going to be limited by the strength of the weakest part. If this is the coupler it will be from 400,000 to 700,000 lb. on most couplers in service, or if the car be equipped with the new M. C. B. coupler type D, this force will be from 600,000 to 1,000,000 lb. Now, if it be the underframe that is weakest, and this may occur if the design is not correct, this pressure will be a little less than that given above for the strength of the coupler. But in any case, this force may be 600,000 lb. Now, if the impact force and shock is 600,000 lb. and the weight of the car is 150,000 lb., the end pressure per pound of car weight and lading will be 4 lb. per pound of weight, or will be equivalent to standing a car on end that has four times as much load in it as the car in question contained. This is what has been knocking out the ends of cars, damaging roofs, side walls, and racking the car in general and on account of insufficient draft gear protection. Now, if the travel and capacity of the draft gear is enough to keep this end force down to 300,000 lb., it would result in practically no damage to the car.

More care must be given the draft gear in the manner of inspection and repairs in order that it may do the work which it was put on for, and which it will do if kept in repair. It may mean new gears or parts of gears, and there will be some expense attached to this inspection and upkeep, but the saving in repairs to other parts of the car is bound to more than make up for this expense.

DISCUSSION

Many favorable comments were made on the paper and it was characterized as a contribution which would materially aid in the study of the draft gear question. Several of the members called particular attention to the need of high

capacity gears. James Coleman, superintendent car department of the Grand Trunk, said that undoubtedly 70 per cent of the indeterminate damage to the lading is due to the fact that the cars in which it is carried are equipped with draft gears of too small capacity. When the amount paid out for claims for damage of this sort is considered, it will show that this question is deserving of careful thought. He claimed that no spring gear is strong enough to withstand the operating conditions as they are found today.

C. W. Van Buren, general master car builder of the Canadian Pacific, brought out the fact that damage to equipment and lading is due to a large extent to the rough handling of the equipment by the yard forces. While speaking in favor of the friction gear he stated that it must be properly inspected and maintained in good condition.

R. W. Burnett, master car builder of the Delaware & Hudson, called attention to the necessity of careful attention being given the draft gear attachments, as they, and particularly the yokes, are responsible for some of the draft gear failures. He also called attention to the wear that takes place in a friction gear and the need for proper inspection and repairs.

G. E. Smart, master car builder, Canadian Government Railways, strongly favored the friction draft gear for modern equipment. There is an economic limit between the

speed at which cars should be switched in the yard and the cost of repairs to the cars caused by the treatment they receive, which should be considered. He favored particularly the use of the metal draft arm in all cases where wooden cars are built.

Among other points brought out in the discussion was that concerning a means for automatically taking up the slack in all friction draft gear due to its wear. The slacks caused by the 4-in. travel recommended by Professor Endsley in his paper was questioned. Professor Endsley answered this by stating that the slack causing the damage to equipment was that to which no resistance was offered. With the draft gear maintained in condition, its 4-in. travel would always be made against some resistance, thus the travel of the draft gear is not as undesirable as the slack or lost motion between the cars when starting trains.

Professor Endsley also again brought out clearly the necessity of providing a center sill under the car that will be stronger than the coupler, so that if anything is to fail it will be the coupler, the idea being to have that part fail which may be repaired the more easily. He recommended a center sill channel of substantial web. For instance, it will be better to have two 12-in., 40-lb. channels than two 15-in., 40-lb. channels, as tests have shown that the former will stand a higher stress than the latter.

NARROW GAGE STEEL HOPPER CAR

Capacity of 40,000 Lb. Obtained on a Track Gage of Two Feet; for Carrying Mine Products in Burma

BY FREDERICK C. COLEMAN

ONE of the many interesting narrow-gage railways in India is that connecting the Burma railways at Nam-yao station with Bawdin, where are situated the Burma mines. This railway is 51 miles in length and is of 2-ft. gage. The ruling gradient is 4 per cent, the minimum curvature is of 90-ft. radius, and flat-bottomed rails weigh-

and a concentrating mill and an electric power installation are also in course of completion.

The trains are worked under a despatching system, and with night running the railway is now handling 900 to 1,000 (long) tons of traffic daily. Arrangements are in hand to increase this capacity to 2,000 tons daily. This considerable

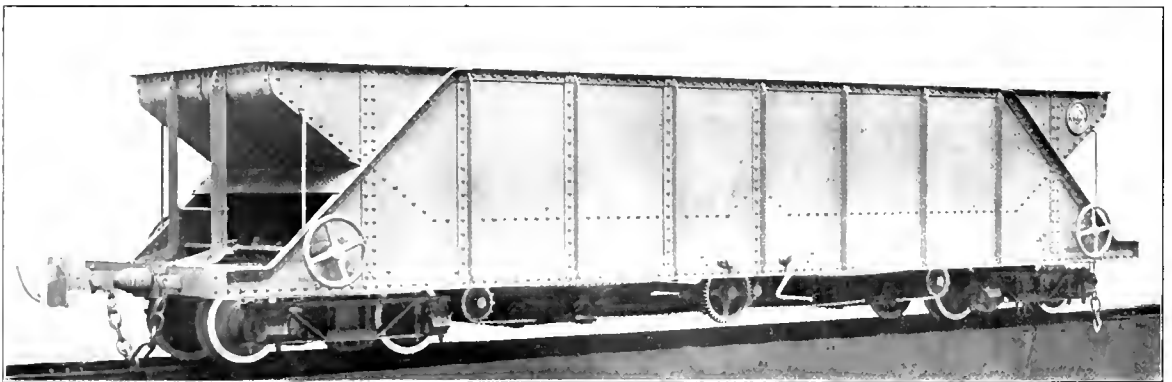

A 24-In. Gage Steel Hopper Car for Service in Burma

ing 41 lb. to the yard are used. The principal outward traffic consists of lead, silver, zinc ore,—the product of the mines,—and lead bullion, whilst the inward traffic consists of machinery and general stores for the mines, including 6,000 to 7,000 tons of coke per annum for use at the mine smelters. At Namtu, the headquarters of the Burma Mines Company, is a large lead smelting and silver refining plant.

development of traffic has called for the introduction of more powerful locomotives and larger freight cars, and a number of all-steel double-hopper self-discharging cars of 40,000 lb. to 44,000 lb. capacity were ordered in Great Britain and are now in successful operation. These cars, supplied by F. R. Rand & Company, Limited, of Westminster, were built by the Blake Boiler, Wagon & Engineer-

ing Company, Limited, of Darlington, England, to the designs of G. H. Sheffield, of 38 Victoria Street, London, and according to the Sheffield-Twinberrow system. The following are the leading dimensions:

Length over end sills.....	25 ft.
Length over buffers and couplings.....	28 ft. 8 in.
Width, inside.....	5 ft. 6 in.
Width, over side frames.....	5 ft. 11 1/4 in.
Center of trucks.....	19 ft.
Truck wheelbase.....	3 ft. 6 in.
Diameter of wheels on tread.....	18 in.
Journals.....	3 in. by 6 in.
Centers of journals.....	4 ft.
Weight of car complete.....	13,200 lb.
Carrying capacity.....	40,000 lb. to 44,000 lb.

The general arrangement drawing shows that the hoppers are 9 ft. between centers. The inclination of the sides and ends of the hoppers is 36 deg. and the openings are placed horizontally 7 in. below the sills. Horizontal doors cover the bottoms of the hoppers.

Each door runs on four rollers carried upon angle bar guides, which are riveted to the framing of the hoppers.

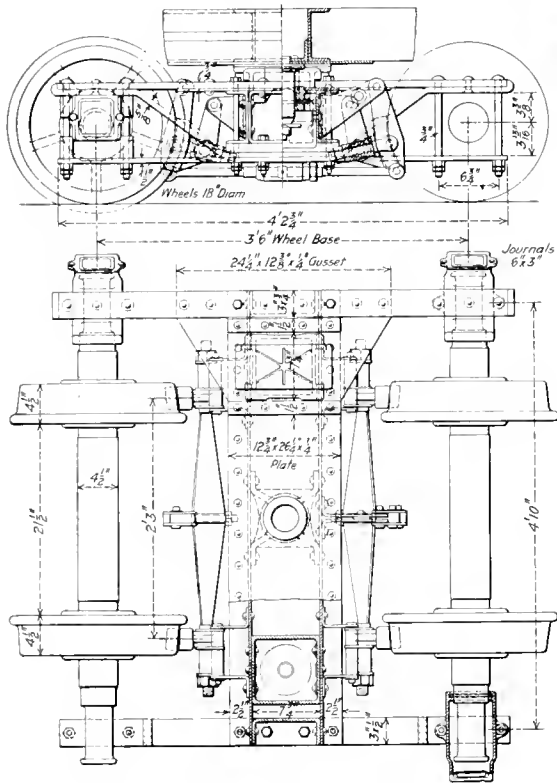

The Truck and Details of the Load Suspension

The horizontal flange of the angle is turned outward so that no dust or part of the load can fall on the guide rail. At each side of the door is a channel bar sill, arranged so that the web passes beneath the rail while the pins of the rollers are fixed to the outer vertical flange. The sliding doors are connected independently to a single reduction winch, by means of chains and sprockets. The winches are actuated from either side of the car by short handles, which fit on the square nuts at each end of the turning shafts. A single operator can work the doors standing clear of the car. The opening or closing of the hoppers may be regulated to any degree, or may be cut off entirely when any desired portion of the load has been run out. The hopper sheets, which act as a bracing for the lower flanges of the sides, are 1 1/4 in.

thick, and the door plates are of a similar thickness. Throughout the general structure of these cars, including the door arrangement, only five British standard sections are employed, this comparing favorably with recent examples of double hopper cars, built in England, which contain as many as 17 standard sections. As the cars are for service over severe grades, powerful screw brakes, operated from either side, are provided at each end of the car and brake blocks are applied to all of the wheels. The standard coupler in use on the Burma Railway is also employed on the hopper cars.

The trucks are designed to permit of the eventual conversion from 2-ft. to 2-ft. 6-in. gage. To effect this change it will only be necessary to renew the wheels, as the axles are designed sufficiently long and the journals so located that the new wheel centers may be spaced out 3 in. further toward the bearings on each side. The brake hangers and brake beams are fitted with ferrules, which will be transferred from the outside of the brake blocks and hangers to the inside, as required for the increase in the gage. Aside from the

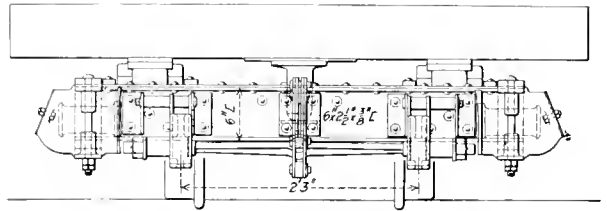
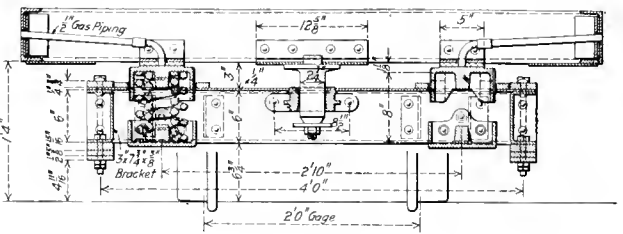

provision for the increase in gage the outstanding feature of these trucks is that the weight of the car is not carried upon a center bearing, but is distributed through groups of coil springs at a transverse distance of 17 in. from the center on each side. The bending moments upon the main transoms of the car and the trucks are thus considerably reduced, and the resultant effect is to make possible a material reduction in the weight of the structure. The springs are compounded to act efficiently when the car is either loaded or empty. They rest in cast steel boxes, the lower parts of which are attached to and between the truck members. The upper, or loose portions of the boxes are provided with large rubbing surfaces which have a sliding contact with corresponding rubbing pieces upon the car transoms. On the drawing of the truck it will be seen that provision has been made for the lubrication of these bearings. Tilting action is allowed for to the extent of the clearance between the center pins and pivot castings, and the spring boxes and side checks on the transoms of the trucks. There is provision for lateral and end movement to suit track inequalities or superelevation.

Rolled steel axles having a tensile strength of 76,200 lb. to 80,600 lb., are employed, together with chilled iron wheels. The wheels are fixed on to the axles at a pressure of not less than 45 tons. Cast steel journal boxes are provided with key plates above the brasses and they are suitable for either pad or waste packing lubrication.

piston engages a lever having a proportion of $4\frac{1}{2}$ to 1. Punch dies and punches are made of the same dimensions and shape as those furnished with standard machines.

The straight air brake valve is operated by foot power, a

angle cock. The excess grinding compound is caught in the recessed discs on the spindles. Oil is led to the spindle bearings through small copper pipes and grooves in the bearing plates.

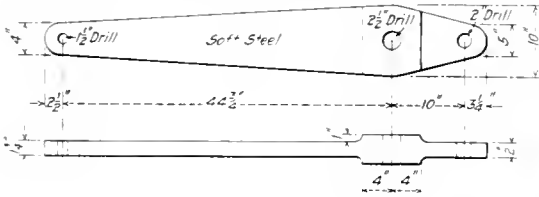

Driving Lever of the Pneumatic Punch Machine

spring attachment keeping the handle of the valve in the release position when not in use.

The machine occupies a floor space of 3 ft. by 5 ft. and is about 5 ft. 6 in. high.

ANGLE COCK GRINDING MACHINE

At the Topeka shops of the Atchison, Topeka & Santa Fe angle cocks are ground on a simple machine designed and built in the shop. The general arrangement of the device is shown in the drawing below. After the angle cocks have been taken apart and cleaned, the keys are placed on the upright spindles, nine in number, in which short studs of the proper size have been screwed. The bodies are then

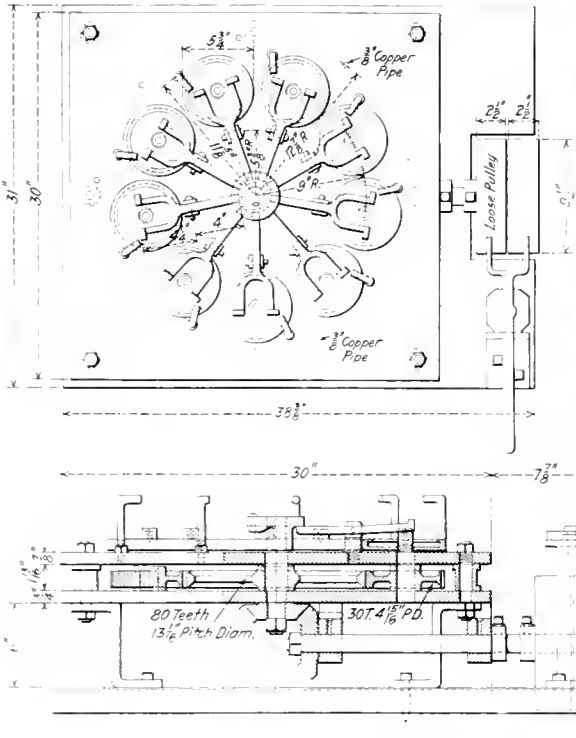

General Arrangement of Machine for Grinding Angle Cocks

placed over the keys and the machine is started. The bodies are kept from turning by the stops placed beside each spindle and every two and two-third revolutions of the key the body is lifted by the cam on the center shaft striking the forked levers, which are pivoted between the spindles and the main shaft and in the normal position rest under the body of the

stem furnish a means for holding the brasses, while a stud running through the center is used to hold the plate to the base. Thus the operations of clamping the brass and turning the plate are entirely independent. When the brass is once set up it can be finished on all four sides by turning the plate.

CHUCK FOR SHAPING MAIN ROD BRASSES

The device shown in the illustration below is in use at the Havelock (Neb.) shops of the Chicago, Burlington & Quincy, and has been found very useful for shaping back end main rod brasses. The base of the chuck is bolted to the side of

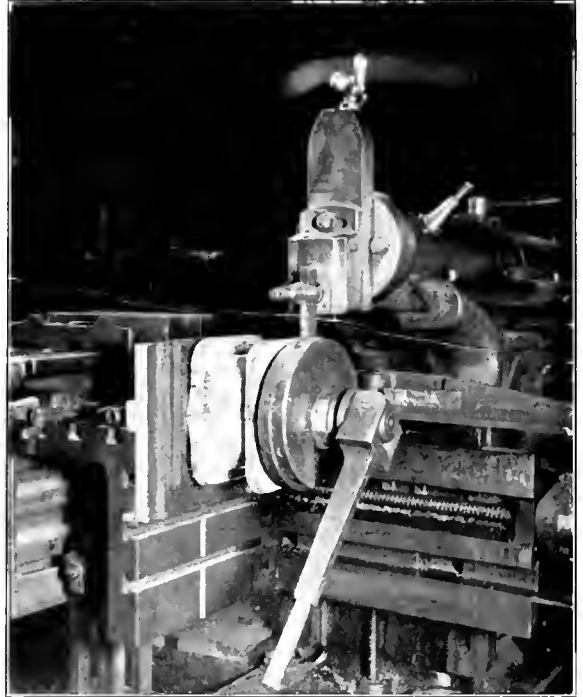

Shaping the Strap Fit on Main Rod Brasses

the shaper table. The center of the base is raised a slight amount above the rest and is squared accurately. Over the raised portion is fitted a plate with a hollow stem in the center and a gib on one side. A nut and a large washer on

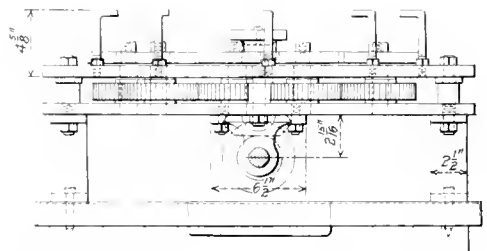



DECREASING ENGINE TERMINAL DELAY

Prize Winning Papers in Competition; The Need of Organization and Supervision Strongly Emphasized

THE following papers are those awarded prizes in the competition which closed October 22. This competition was conducted for the purpose of bringing out ideas which would be of immediate assistance to our readers in putting locomotives through their own terminals with despatch. There were thirteen papers presented in the competition, most of which were good. Those which have been accepted for publication will be published in future issues.

IMPROVE TERMINAL FACILITIES AND INCREASE SUPERVISION

BY O. T. DICKENS

(First Prizes)

In planning to get the quickest possible turning of power at terminals it should not be necessary to go into the details of the procedure followed at any particular place, as the layout and capacity of terminals differ, also the regulations under which the terminal officers work are different on many railroads. The following suggestions are given with a view of getting the best results under every condition.

There are a great many things to be considered. The condition of the power, the conditions under which the power is being worked, the terminal and engine house conditions, and the terminal, shop and operating staff. The condition which the power is in, is perhaps the most vital and should receive the earnest attention of all concerned. If we are to move trains over the road in the shortest time we must keep the power in good condition. In order to do this we must have at the head of the mechanical department men who thoroughly understand their business and who realize that the success or failure of the most important and the most vital proposition our country and its Allies have ever had to handle depends to a large extent upon them. They must be assisted by men who will not lose sight of the same fact and these men in their turn must instill the same spirit into the rank and file coming under them. The executive abilities

of each and every man must be used to the fullest extent and the forces must be organized to get the maximum results. Men who encourage poor work in order to gain time are only losing time in the end and their work only ends in disaster. These men must be educated or put aside to make room for those who are willing and anxious to live up to the requirements of the times.

We will assume that we are entering into the movement at the terminal with power in good condition and this condition must be such that the power can be kept out of the main shops for general repairs until it can be handled without delay. If we are to get the maximum results power must not be held out of service awaiting repairs. With this condition, there is no reason why it should not make considerably more mileage than it did formerly. In other emergencies power has been kept out of the shop several months longer than was originally intended and surely in this emergency we can do better. The track and shop conditions at the engine terminal should be such that the locomotives may be received, repaired and made ready for service with despatch. It may be possible to redesign the engine terminal but some of the necessary helps which the roundhouse foreman has been requesting for some time may be furnished.

Ashpits which are continually full cause endless delay. They discourage the workmen and cause them to be indifferent as they see how indifferent the management is to such things. The ashpits should be kept clean and put into condition so they may be easily kept clean. The same thing applies to a good many out of date appliances in the engine terminals and particularly to machine and hand tools. Some of the items which will go a long way towards making the prompt despatching of locomotives possible are steam grate shakers, up-to-date coaling and sanding facilities, good roomy ashpits, turntables which accommodate the largest power used on the division and which are equipped with power tractors, washout plants for washing with hot water, an engine washing plant, and autogenous welding apparatus. The use of brick arches will also assist greatly. The

supervision of the repair work should be in the hands of men who know how to get the best results from the facilities and who are able to devise methods to otherwise shorten the time required to do the work without sacrificing the quality of that work. The roundhouse staff must be organized so that from the time the power arrives at the shop track there is no time lost.

Supervision must commence from the time the locomotive is placed on the house track and must be carried on until it is turned out again for service. A competent staff of hostlers should be maintained who will handle the locomotive quickly. They should be kept informed by means of bulletin boards what repairs are necessary to each locomotive in order to place them on the proper track in the house. Engine inspectors must perform their duties quickly and at the same time make intelligent work reports. No time should be lost in assigning the workmen to their various duties and where ever possible the work should be specialized. Power which is in condition to turn without repairs should be given preference in handling and it would be desirable where possible to handle this power separately from that which must go into the house for repairs, wash-out, boiler tests, or other work which necessitates keeping it out of service for a time. Power may be run over two divisions if the road conditions will permit, with a saving in time at the terminals and a decrease in the coal consumption.

If every move made is watched closely we can get a large increase in the efficiency of every terminal, be it up-to-date or otherwise, and the question of supervision should be carefully considered. Supervision does not mean driving men; it means educating them and the workmen are the better for it. By constantly checking the movement of power on the incoming and outgoing tracks and by having foremen see that the repair work is promptly and properly done, more will be done to expedite the quick handling of power than anything else. We cannot expect to get very much in the way of new equipment and therefore must make the best out of the existing conditions excepting that we should eliminate any condition which hampers the movement. The night conditions should be brought up to, as nearly as possible, the conditions which prevail in the day time. Adequate lighting in the engine house and the surroundings is of considerable importance; the efficiency of the staff depends on it more than any other condition. The night force too should receive the same attention in regard to organization and supervision as the day force. Our railroads are not in the habit of closing down from sunset to sunrise yet if we were to compare the day and night force and the work required of them in some of our terminals we would wonder that power was moved during the night at all.

We must not forget there are others besides the mechanical forces who are responsible for the delay of locomotives at terminals. The dispatcher's office has been found to be one of the most important places to look to for improvement in the conditions we are discussing. If any obstacles are placed in the way of trains making a reasonable time over the division they frequently lead to defects in the locomotives which add considerably to the time taken to repair them at terminals. For instance, locomotives held at sidings during cold weather have a tendency to develop leaky boiler tubes and this is one of the most frequent causes of engine failures or of excessive time preparing power for service. The terminal facilities should be studied and improvements made which will permit the power to be delivered promptly to the engine house from the train and vice versa. Power which takes from twenty to forty minutes to be so delivered one half mile is unduly delayed and the condition responsible for this should not be tolerated. Yardmasters should make it a point not to delay power and should see that their

subordinates are not allowed to do so by blocking the tracks. The condition in which the power is left by the enginemen on the engine house track should be watched and the enginemen should be encouraged to help all they possibly can. By tightening up loose nuts, setting up wedges, keying up brasses or tightening joints, they can be of material assistance. The road foreman of engines should devote his whole time to the power in order that the mechanical department may have the benefit of his experience and help, and be kept better informed on the condition of the power through his reports. The number of road foremen required for each division has been poorly calculated and the work required of them has been too great. In many cases we should have two and three road foremen where now we have but one; and even at that the railroad company would be financially better off and the motive power would be kept in better condition.

The labor situation is serious and must not be overlooked. Experience in hiring men for enginehouse work shows that it is hard to get experienced machinists, fitters, and boiler-makers. Men who are fitted for general repair shops are often unfitted for running repair work. To overcome this trouble apprentices to the trades mentioned should be required to put in the last six or eight months in engine houses. Enginemen will also be hard to get and on roads where assigning of crews to locomotives is practiced the pooling system should be followed. Power tied up ten to twelve hours for the crews' rest in order to allow assigned crews to follow their engines is not a good policy and on a division of one hundred and fifty miles or over of single track the crews cannot possibly follow their engines without rest. The pooling system will not likely find favor with the mechanical department officers but there does not appear to be any other way out of the question with the present power and man shortage. The stringent rules made by the Federal authorities for the maintenance of power will require revision if we are to turn power quickly. This can very easily be done without danger.

The relations between the officers and staff of the operating and mechanical department must be the best. Too often we see some over zealous operating officer unjustly criticizing the mechanical department and here we find one of the greatest handicaps which confronts the mechanical officers. The division on which this condition is allowed to exist will not be able to meet the present requirements. It must be distinctly understood that the responsibility for the success of the railroad rests with all the departments and if there is a weak link, all should assist to strengthen it and not to further weaken it by improper and unfair criticism. What we require today are officers who will aid as well as criticize. The purchasing and stores department also have their difficulties and many allowances will have to be made, yet it should be borne in mind that no effort must be spared to keep the mechanical department supplied with necessary material. The heads of these two departments should work together in an endeavor to alleviate the material shortage and wherever possible material must be reclaimed and substitutes used.

To sum up the situation the following would appear to be the requirements:

Improve as much as possible the terminal and shop facilities including the building of long inspection pits, where the inspection and repairing may be carried on outside of the engine house when weather permits. These pits should be built on incoming and outgoing tracks and should be used to the limit.

Eliminate conditions which hamper the work.

Apply labor saving devices in the shops and on the locomotives.

Improve the organization and increase the supervision.

These requirements together with the friendly relations

of all departments will insure that power will not be delayed at terminals or on the road.

GETTING THE LOCOMOTIVES THROUGH THE TERMINAL

BY T. S. GRANT
Foreman, New York Central, Watertown, N. Y.

(Second Prize)

The man in charge of the engine terminal at the present time has more responsibility than he ever had before. The transportation department have more cars to handle which must be handled without delays at the terminals. The engine house foreman must make the necessary repairs to the locomotives and turn them in the least possible time. On account of the heavy service the amount of repair work has materially increased.

To make these increased repairs successfully and despatch the locomotives with less terminal lay-over than has previously been allowed, the work must be systematized, the organization must be such that the greatest efficiency is obtained.

To best meet the requirements for a large engine house, there should be an outside inspection pit with the engineer's work report office located near by. There should be an assistant engine house foreman and five gang foremen; one in charge of pistons, valves, piston rod and valve stem packing, crossheads, guides and valve motion work;

been written up by the work report clerk, to the engine house foreman.

Forty-five minutes after the arrival of a locomotive at the terminal, allowing ten minutes for taking coal and sand, fifteen minutes on the inspection pit and twenty minutes for dumping the grates and putting the locomotive in the house, the engine house foreman should be able to give a very close estimate as to the time the locomotive would again be ready for service. My experience has been that the most lost motion occurs at this stage of the terminal work, as the engine house foreman does not know what work is necessary on the locomotive, and the locomotive is not always placed in the proper stall by the hostler to do the required work to the best advantage. With an assistant engine house foreman and an outside inspection pit this lost motion can be eliminated.

The assistant engine house foreman would require about thirty minutes for each engine handled in this manner, but with an assistant to act as messenger, he could cover the required duties in twenty minutes, or thirty-five engines in twelve hours, allowing lunch time.

The boiler inspector after making his report to the work report clerk should immediately report all boiler defects to the boilermaker foreman. He knows the general condition of the flues and fireboxes on all the locomotives, and if the practice of dumping an engine at the end of each trip is followed, as it should be, he knows that there will not be many plugged flues. As the present time almost all

Machinery													Boiler						
Stall	Engine	Gang #1	Gang #2	Gang #3	Gang #4	Gang #5	Air Work	Greaser	Carpenter	Misc.	Engine to be Ordered	Washout	Gang #5	Cool Down	Fill Up	Front End and Ash Pan	Caulking	Clean Flues	Fire Up
1	411	X						OK	X	J.S.	2 P.M.	Yes	OK	Yes		OK		OK	
2	212		X	X		X	OK	OK			1 ³⁰ P.M.	Yes	OK	Yes		OK	OK	OK	OK
3																			
4	4720	X	X		X		OK	OK		G.D.	11 ³⁰ A.M.	Yes	OK	Yes	OK		OK	OK	
16																			

Work Board for Engine House Repairs

one in charge of rod work; one in charge of wedges, binders and driving journal bearings; one in charge of springs, spring rigging, engine truck wheels and bearings, tank wheels and bearings, pilot and tank beams and pilots, etc., and one in charge of cab and pipe work. These foremen should be numbered, one, two, three, four and five respectively. In addition to this there should be an air brake gang.

With the outside inspection pit the air brake inspector can test the pump and all air appliances on the locomotive while it is under steam and has a full pressure of air, while the engine and boiler inspectors are making their inspection. The assistant engine house foreman should, on the arrival of a locomotive, consult the work report book noting all defects reported. He should call the air and boiler inspectors' attention to any defects reported which come under their jurisdiction, and also make an inspection of the other defects in conjunction with the engine inspector, while the other inspectors are doing their work.

Rod pounds and blows reported should be examined and located while the locomotive is being put on and taken from the ash pit and into engine house. The assistant engine house foreman should follow the locomotive into engine house, placing it in the stall best adapted to make the required repairs, and spot the locomotive so the repairs may be made easily. He should then report all work that should be done, except the boiler work, which would have

flues are welded, they are not often found leaking. In most cases his repairs will consist of caulking the mudding or a few staybolts, or making repairs to the front end or grates.

Immediately upon receiving the work slips, the engine house foreman should classify and distribute them into the receptacles provided for them on the working board, of which a diagram is shown, and, if necessary, to cool down boiler for throttle, gauge cocks or any other mountings to so advise the boiler maker foreman. He should then decide when the locomotive will be ready for despatching.

It is not necessary to go into detail in regard to the manner of doing the work or the time required, the essential point now is to get the men started on the work and to see that it is completed in the time given. The gang foremen must watch the board as closely as possible and distribute their men so that the work will be done on time. When the work is started on any locomotive, the slips are to be removed from the pocket, and a cross placed in the space adjoining. This will signify that a part of that gang is covering the work on that particular locomotive; but the slips are not to be removed until the work is started. In the column headed, "Miscellaneous," the engine house foreman will place the initials of the workmen in the line opposite the engine number to which the work is given.

Immediately upon completing their work, the different gang foremen, carpenter or workmen having miscellaneous

slips, will erase the cross or initials placed in the line opposite the locomotive number, which will signify that their work is completed. The air gang and greasers will "O. K." each locomotive opposite the engine number in their respective columns. On the boiler work side of the board, the items as shown by the different headings will be marked "O. K." on the line opposite the engine number when the work is completed and gang number five, which is shown on each side of the board, will do likewise when they are ready to have the boiler filled and fired. The different gang foremen should consult the engine house foreman on all jobs out of the ordinary or when they are tied up on some particular job. The doping, filling of grease cups, headlights and markers should be taken care of at the same time under an overseer. This gang to be known as the greasers. By this system several of the gangs would be doing their work on the locomotive at the same time to eliminate long terminal lay-overs.

In addition to the running repair work board, a board should be maintained in the engine house showing all locomotives in for repairs which will require twenty-four hours or more to complete. This should show the work required and should be corrected each morning as the repairs are made. Locomotives in this class should have all necessary side rod bushings applied, the throttle ground, flues rewelded and all other repairs of this nature made, to assure short turns on the following trips.

Good tools, properly cared for, are as essential in this emergency as good men and a good system. They should be handled from a tool-room centrally located, with the attendants constantly on duty, using a checking system for the distribution of all company tools.

Keeping the engine house and pits clean is a great help to a workman; he will accomplish much more good work in a clean pit than he would crawling over a pile of cinders or stumbling over something on the floor. Have a place for everything and keep everything in its place.

At the present time, more so than ever before, it is necessary to follow all the work closely in every detail and to assist the workmen by offering suggestions wherever possible to increase their efficiency. A proper supply of the necessary tools and supplies is also necessary. The proper co-operation between the night and the day forces is of the most vital importance. On changing shifts the engine house and boiler-maker foremen should give to their successor a transfer sheet showing the true condition of all locomotives in the terminal at that time.

Improper conditions found and reported by either terminal or night foremen should not be considered as complaints, for by knowing of these conditions they are enabled to make the proper corrections which will be for their benefit as well as that of the service.

In the present emergency, when the railroad companies are going to get more miles between shopping than ever before, it will be necessary to transfer both men and machinery to the engine houses, as this is where the work must be done.

HANDLING LOCOMOTIVES AT TERMINALS

BY K. R. MITCHELL

(Third Prize)

The time a locomotive spends in a terminal commences and ends with the operating department, in consequence of which treatment of the subject of engine terminal delay should properly be divided into two parts; the mechanical or strictly engine house end of it and the operating end. The writer being immediately concerned with the mechanical end will confine this article to that phase of the subject except for that part of the operating end which is inseparable from it.

It is vitally important that perfect co-operation exist be-

tween the yard and engine house forces if the best results are to be obtained. The yard master being the first one in control of a locomotive after its arrival with a train should see that there is no delay in sending it to the engine house. If the work is to be done with the fewest possible number of locomotives this is a very important matter as every few minutes' delay in receiving a locomotive from the yard means a great deal to the engine house foreman.

Rather than burden this article with a description of the details of handling locomotives which are common to all engine houses only the more dominant methods that actually affect or influence the time of handling locomotives as used at a fair sized engine house with which the writer is connected will be featured.

The first work done on the locomotive after it is received at the engine house is at the inspection pit or pits, as two are necessary if locomotives are to be inspected expeditiously during times of congestion. It is not possible to reduce the time of inspecting to less than six or eight minutes as that is the minimum time in which the air brake test can be made strictly in conformance with Federal requirements. However, by having one or more machinists or helpers at the inspection pit quite a little work may be done in the way of tightening up bolts and nuts and any other small jobs which will reduce the time it is necessary to keep locomotives in the engine house. Sometimes this will make it possible to run a locomotive direct from the ash pit to the storage yard, avoiding the engine house altogether. An inspection of the sponging and the necessary attention to the journal boxes of tender trucks may similarly be given at this time.

Reports of the work to be done on the locomotive which are made by the inspectors on properly printed forms are "shot" by air tube to the office of the engine house foreman. This gives the foreman and his assistants information that will enable them to make the necessary provision for the disposal of the locomotives in advance of their arrival at the turntable. At the same time the hostler who receives the locomotives from the crew ascertains whether or not the boiler is due for washing, whether the stay bolts are to be tested or if, for any other cause, the fire should be drawn. He likewise sends a report to the office by air tube and the necessary instructions are telephoned to the ash pit before the arrival of the locomotive at that point. A clerk accompanying the inspectors noting the defects found and subsequently transferring his notes to the printed form or even entering them directly on it may profitably be employed at times of congestion to save the time spent by the inspectors in writing their reports.

An adequate force of fire cleaners should be maintained at the ash pits to prevent the accumulation of locomotives between that point and the inspection pits. Assistance may be given the ash pit force with a resulting saving in time at times of congestion to help in disposing of the cinders. Quite some time may be saved by dumping the cinders directly into the pits and cleaning them out by means of a travelling crane equipped with suitable clam-shell bucket. By this method the passage of the locomotives over the pits is not obstructed by buckets to be hoisted out of the pits by air hoists or other stationary means and cinders may be removed at any point throughout the length of the pits. The piecework system of payment has been found to be of advantage both in decreasing the time and cost of doing the work. At engine houses where the coaling facilities are unfortunately placed between the ashpits and turntable only strict supervision can keep the time the locomotives are being coaled down to a minimum.

During congested periods it is essential that the foreman or his assistants give his personal attention to the entire movement of locomotives between the inspection pits and turntable or the time of handling will increase considerably.

This is more particularly true in winter as the men are then working at a disadvantage and require not only encouragement but the sympathy of the foreman to keep them up to their best efforts. Unfailing good humor and tact on the part of the foreman under such conditions as well as the authority that is his by virtue of his position will work wonders in "keeping things moving." It has been found advisable to place a gang-leader in charge of the hostlers, engine preparers and ash-pit men at night, as operations are not naturally performed as smoothly and rapidly during the dark hours as they are in the daylight.

The reports of the enginemen and inspectors which have reached the office before the locomotives are placed in the house are taken by a clerk who is trained for the position. He records the repairs to be made on various printed cards according to the class of men who will make the repairs. For instance, all boiler work is written on one card, air brake work on another, machinist work on still another, etc. These cards are then given to the respective gang leaders, who are thus informed ahead of the arrival of the locomotive as to what work they will have to do on any particular locomotive. Special work that relates to the handling of the power may then be discussed between the gang leaders and foreman and plans made according to the needs of the service, i. e., whether to work on this or that locomotive in preference to another, how much of the work is to be done at the time and what work to leave until the locomotive returns from another trip. In this way much valuable time is saved.

Where engine house or stall room is limited, locomotives sometimes accumulate between the coal wharf and the turntable awaiting their turn to get into the house. While this cannot always be avoided, advantage may be taken of the time locomotives are lying there to test stay bolts, calk flues or do some work that does not involve pit work or jacking up. In some cases new fires may be built before placing the locomotives in the house.

In the engine house it has been found that by increasing the number of gang leaders so that each one will not have more than eight or ten men in his charge, and holding the gang leaders responsible for the quality of the work done by the men, much time has been saved, not only in getting the locomotives over the road but in future repairs as repairs having once been properly made last longer than those that are made indifferently. Another thing that means the saving of considerable time eventually, while extending it at one particular handling, is that of requiring a special and very thorough examination by one or the other of the gang leaders at the boiler wash or test periods. At this time all parts, the condition of which is controlled by tolerances, are checked up and various other parts of the machinery and appliances are examined in conformance with a standard list prepared for the purpose and the condition noted on a form. The object of this is to renew or repair all parts that do not appear to be in a condition to last until the next boiler wash day arrives. In other words, the time that the locomotive must lie up for boiler wash is taken advantage of in using every known means to put the locomotives in such shape that they will stay in service with a minimum amount of repairs until the following boiler wash day. As we are fortunate in having to wash boilers only once in four weeks it will be seen this method of inspection and repairs will save time in the end.

A pit in the storage yard to enable the sponging of boxes and other light work is of great assistance in reducing the time of handling locomotives, for by this means some locomotives may go directly to it from the ash pits and others may be moved from the engine house to be finished there, thereby making room in the house for another locomotive sooner than otherwise would be the case.

While it is undesirable to get up steam too rapidly, time

in the preparation of new fires may be saved by the use of shavings soaked in crude oil. Two buckets full of shavings and six pounds of oil are sufficient for the largest fireboxes, but the operation may be hastened if desired by slightly increasing both.

Machinists and their helpers as well as air brake men both day and night working piece work materially affects the time locomotives are undergoing repairs. The matter of tools and machinery is most important. Every engine house should be equipped with enough hand tools from jacks to wrenches so that there will be no waiting by any of the mechanics for this or that tool. A well arranged tool room, ample in size and kept in an orderly condition by an efficient man who is capable of making necessary repairs to all ordinary tools, cannot fail to have a beneficial effect on the quick handling of locomotives while undergoing repairs. Special appliances for hastening the work of repairs are a necessity. There should not be a lack of the machines necessary to make the parts of locomotives that must be repaired in the machine shop as this will cause a loss of time. By having a blacksmith and helper on duty at night, hours may be saved by avoiding the delay incident to waiting for the day men to come to work.

No matter what the facilities are for handling locomotives the best results will not be obtained from them without the aid of a good live foreman who is tireless in getting after the lost motion and reducing it, for it is the lost motion, particularly between the various operations, that swells the total time of handling.

The yard master may assist materially in preventing congestion and consequent lengthened time in handling by sending his shifting locomotives to the engine house singly instead of a number at the same time, and were he to take so much interest as to consult the foreman as to the latter's convenience and if necessary retard the movement towards the engine house of the shifting locomotives, that would be co-operation indeed and it would be productive of very good results.

When the locomotives have been placed in the storage yard and marked ready for service it only remains for the engine house people either to maintain banked fires or fires in such shape that a full pressure of steam may quickly be raised, depending on the time for which the locomotives are ordered; in this way coal may be saved in one case and in the other case time may be saved when the crew reports for duty.

The time of preparation by the engineman is considerably reduced by having a man in the storage yard to fill the lubricators and grease cups on locomotives equipped with the latter. The same man also may give a final inspection to see that no work has been left undone, thus saving the annoyance and delay in making repairs when the locomotive is otherwise ready to leave.

The final terminal delays are strictly up to the operating department and the responsibility lies between the trainmasters and yard masters.

If after doing everything that lies in his power to get locomotives ready for service as quickly as possible the engine house foreman sees them standing for hours on his storage tracks he may question the necessity of his hustling quite so hard and perhaps slack up a trifle, but a good foreman will not do this because he will realize that by maintaining the highest degree of efficiency at the engine house he is providing the operating department with the means in the shortest possible time for moving the vast amount of freight and incidentally place the other fellow in the awkward position of responding to the "Why?" thus lightening his own burdens to such an extent that he will have yet more time to devote to still greater achievements in the way of reducing the time of handling locomotives at the engine house.

WOMEN WORKERS IN RAILROAD SHOPS

Serious Labor Conditions Are Leading the Railroads to Employ Women for Many Classes of Work

THE depletion of the forces of the railroad shops of this country, which during the past year has been very serious, seems now to have reached a point where any further reduction will inevitably result in a loss of efficiency in that department of the railroad organization. It was thought by many that after the men who were chosen for the National Army were called there would be few changes in the force, but this has not been the case. The railway regiments now being formed for the purpose of rehabilitating the Trans-Siberian railroad will of course take their quota from the railroad shops, and the increasing requirements of other branches of the Government service will result in the with-

drawal of considerable numbers. Of greater consequence, however, is the readjustment of labor, which will proceed slowly for a considerable period. Many of the war industries have lost men through the selective draft, and a part of the positions thus made vacant will surely be filled from the ranks of railroad shopmen, some of whom place the higher wages to be secured elsewhere above the permanence of employment which the railroads provide.

It is quite unnecessary to state that no curtailing of the output of the railroad shops can be permitted at this time. In spite of all that the railroads can do, cars and locomotives will deteriorate faster than they can be repaired. Daniel Willard, in his address on "Railway Efficiency and the War,"* made it clear that the efficiency of the railroads will play an important part in winning the struggle. To keep the equipment of the railroads of this country in condition has now become a patriotic duty.

How is the labor situation to be met? In spite of the numerous wage increases which the roads have put into effect since the beginning of the war, it is impossible for them to compete in the labor market with plants manufacturing war supplies. Even if it were possible to put wages on a plane that would draw men from other industries, many would be taken from shops whose work is essential at this time, and the nation's productivity would not be increased by the shifting of workers. Labor-saving machinery might help the situation in some cases, but it is almost impossible to secure tools at this time, owing to the unprecedented demand. The logical way out of the difficulty seems to be to employ women in greater numbers for doing work in the shops.

Many roads have introduced women workers in the mechanical department, among them being the Baltimore & Ohio, the Erie, the New York Central Lines, the Minneapolis, St. Paul & Sault Ste. Marie, the Chicago, Burlington & Quincy, the Northern Pacific, the Union Pacific, the Oregon Short Line and the Chicago, Milwaukee & St. Paul. On most of these roads the employment of women has passed the experimental stage, and sufficient data are now available to make it possible to judge the value of women in shop work. Some observations made in shops where women have been employed for some time will show the progress that has been made in this direction.

The difficulties encountered in introducing women workers in the shops have not proved serious. Rooms in which women can change from street to shop clothes, rest rooms and toilet facilities are, however, essential. Where women are employed around shops, skirts are in most cases a hindrance and sometimes a source of danger. It is, as a rule, unnecessary to urge the adoption of more suitable attire, the women workers being quite willing to don loose overalls. Women

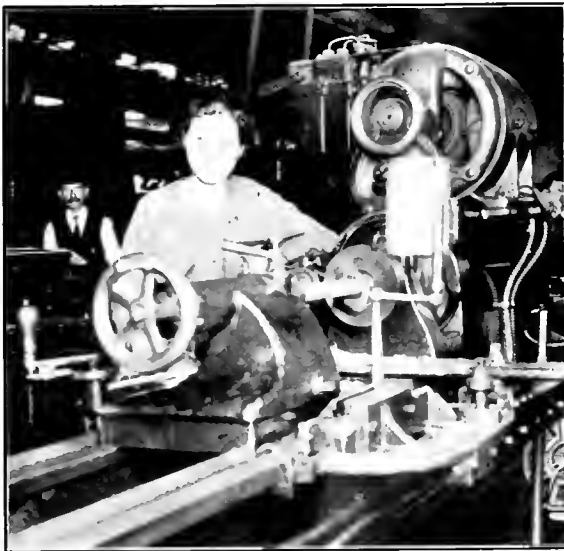

An Expert Machine Operator Who Was Formerly a School Teacher

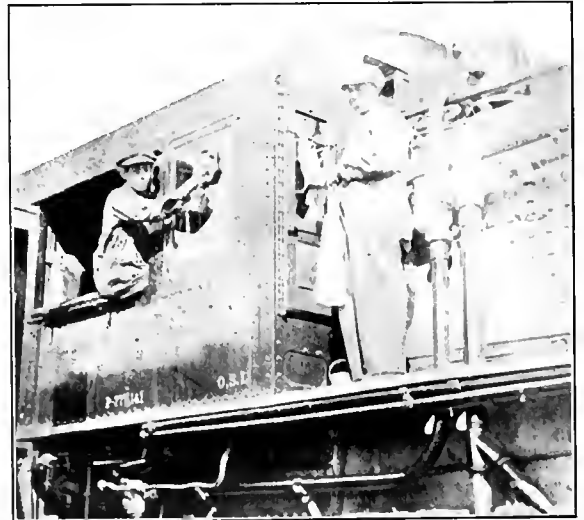

Women Cleaning Locomotive Cabs at the Pocatello Roundhouse, Oregon Short Line

who work around power-driven machines should wear caps, to preclude the possibility of injury by loose strands of hair catching in shafting or belting. In many states the hours of labor of women workers are limited by statute and special reports are sometimes required, but these are of such a character as to require but little clerical work.

On many railroads women have heretofore been excluded from the shops to such an extent that it is an easy matter to find positions, for which women are quite as well fitted,

*See *Railway Mechanical Engineer* for September, 1917, page 489.

now filled by men. For example, there are a great many male clerks employed in places where women, after a short period of training, could handle the work with little difficulty. At the Havelock, Neb., shops of the Chicago, Burlington & Quincy a woman is employed in distributing blue-prints with entire success, although the work requires some knowledge of locomotive parts in addition to an understanding of the filing system. At Havelock women are also doing work which requires considerable skill, such as operating lathes, milling machines, gear cutters and shapers. Their work has been found highly satisfactory, and, though a trifle slower than men, they seldom make mistakes and do very accurate work.

An instance which shows the natural adaptability for machine work that some women display will serve to indicate the possibilities for women in railroad shop work. A young lady who, after graduating from a university, had been

extent in this shop than in any other in this country. The effort to relieve the labor situation in the shops in this way has been so successful that probably if it were possible to get more women for shop work they would be employed in even greater numbers. No special training was provided for



A Woman Operator at the Pocatello Shops of the Oregon Short Line Milling the Ports in a Valve Chamber Bushing



Colored Women Working on Bolt Cutters at Pocatello Prove as Efficient as Men

the women workers except such as is usually given to apprentices. The instructor who directed the work of the apprentices also instructed the women. All the women at Pocatello are under the supervision of men, but at Salt Lake, on the same road, where a great many women are employed as coach cleaners, a woman is in charge, who reports to the foreman of the coach department.

In the machine shop women are employed in the operation



Women Employees Grinding Tools at the Havelock Shops of the C. B. & Q.

teaching the sciences in a Nebraska high school, secured a position in the Havelock shops of the C., B. & Q., thinking the experience she could gain during the summer would be of value to her in teaching. She became so proficient that she was assigned to lathe work in the tool room, and the work proved so fascinating that she resigned from her teaching position. Although the lady in question had intended to remain in the shops indefinitely, her stay there was limited to three months. At the end of that time a vacancy occurred in the general offices of the mechanical department, for which she was particularly qualified by reason of her shop experience, and she is now holding a responsible position in the offices of the general superintendent of motive power.

At the Pocatello, Idaho, shops of the Oregon Short Line women are now handling a large part of the work in the machine shop and car department on which male help was previously used. Women are probably employed to a greater

of engine lathes, boring mills, milling machines, planers, brass lathes, drill presses, cutting-off machines and nut-tapping machines. Most of the women are kept on specialized work. Those who show special adaptability, however, are

trained on machines of all kinds, and some are capable of running almost any machine in the shop. It is the opinion of those in charge that a considerable proportion of the women workers could readily be developed into skilled machine operators.

The reclaiming and repairing of cab cocks, globe valves, boiler checks and miscellaneous valves is now done largely by women. In the tin shop they are repairing lanterns, oil cans, etc., as well as doing general tinsmith work. A woman is employed to run the motor-driven transfer table. Stay-bolts are finished in the boiler shop by two women, who are doing as good work as the men who formerly ran the machines. All parts of locomotives are now painted by women.

In the coach shop women are doing the upholstering, cleaning coaches and preparing them for painting. Two colored women work almost entirely at painting and varnishing coach sash. While men are still employed on engine

wiping, cabs and windows are cleaned by colored women.

It has been found that the output of the women workers employed at Pocatello compares very favorably with the output of male help, and, with efficient supervision, the quality of the work is equally good.

At other shops women are employed on various classes of work which have not been mentioned, acting as helpers for machinists, blacksmiths and car repairers, operating steam hammers, building grain doors, packing journal boxes, reclaiming waste, sorting scrap and cleaning yards and shops.

At least one road has employed women as tracers in the drafting room, which suggests a method for relieving to some extent the serious shortage of draftsmen. In general, the experience which the railroads have had with the employment of women in the shops seems to indicate that it offers in many cases the only satisfactory solution of the labor problem of the mechanical department.

LUBRICATION OF AIR COMPRESSORS*

A Discussion of Problems Encountered in This Work and of the Characteristics of the Oil to Be Used

BY THE LUBRICATION ENGINEERS' ASSOCIATION OF THE TEXAS COMPANY†

THE compression of air results in the conversion of the energy used into heat. The rise of temperature of a volume of air under compression follows certain laws, and tables have been compiled which show the theoretical temperatures the air will attain when compressed to certain pressures. The following table gives the temperature that air will attain taking the inlet at 60 deg. F.

Gage Pressure	Atmospheres	Final Temperature
0 lb.	1.	60 Deg. F.
25 lb.	2.7	234 Deg. F.
50 lb.	4.4	339 Deg. F.
75 lb.	6.1	420 Deg. F.
100 lb.	7.8	485 Deg. F.
125 lb.	9.5	540 Deg. F.
150 lb.	11.2	589 Deg. F.
200 lb.	14.6	672 Deg. F.

In actual practice, however, the temperatures never reach these figures, for the reason that in the economical operation of compressors it is very important that the temperatures be kept as low as possible. For this reason the compressor cylinders and cylinder heads are provided with jackets through which cold water is circulated to absorb as much of the heat of compression as possible. A large percentage of the trouble experienced with air compressors is on single stage compressors. Examinations have shown that in many instances this is due to the fact that they are overloaded from being forced beyond their capacity, excessive heat being generated thereby.

Where the air is compressed through more than one cylinder, the temperature of the air is still further reduced by passing it through intercoolers on its way from one cylinder to another. The water side of intercoolers and water jackets should be kept free from all dirt, mud, and other foreign matter, which the cooling water is apt to bring with it. This foreign substance can be detected by watching the discharge from the jackets or coolers. The failure to observe this precaution has in some cases been responsible for air compressor explosions as jackets and coolers become very inefficient if they are coated with mud or scale.

* Abstract of an article printed in Lubrication which is published by The Texas Company, New York.

† Papers on this subject were submitted by the following members of the association: Messrs. W. M. Davis, Douglas L. Keys, W. A. Edmundson, H. K. Eilers, J. N. Prewitt, H. J. Wilson, Howard Cooper, John H. Young, Jr., F. A. Neale, H. W. Salvador, H. E. Joseph, J. T. Snow, C. M. Roe, A. Nielson, W. A. Lawlwick, J. D. Barton, C. H. Kennerly and J. W. McGuire.

EXTERNAL LUBRICATION

The external lubrication of air compressors does not differ from ordinary external lubrication. In the case of steam driven compressors the main bearings, crank pins, cross-head pins, and cross-head guides are usually lubricated by a splash system. In some cases the crank pins are fitted with pendulum oilers with stationary cups, and the other bearings are fitted with sight feed oil cups.

In design and construction the air compressors of the ordinary or piston type is similar to a steam engine. The action, however, is the reverse of the steam engine, for in the case of the air compressor cylinder, power is transmitted to the piston through the shaft and connecting rod, instead of from it.

INTERNAL LUBRICATION

So far as internal lubrication is concerned, the problems offered by the steam engine and the air compressor cylinder are entirely different. In the steam engine, moisture, which has a tendency to wash the oil from the surfaces of the cylinder and valves, is always present to a greater or less degree, requiring in most cases, the use of a compounded oil. In air compressor cylinders, on the other hand, the surfaces are dry, and so compounded oils are never used. Moreover, less oil is required for the air compressor cylinders, since the oil is not washed off the cylinder walls.

As in the case of steam cylinder lubrication, the conditions of the internal surfaces, the piston speed, and the weight and fit of the piston must be taken into consideration in selecting the proper air compressor oil. Low speeds and heavy or loose fitting pistons require a higher viscosity oil than high speeds and light or tight fitting pistons. Other important factors which govern the lubrication of air compressors are the degree to which the air is to be compressed, the location of the air inlet, the method of applying the lubricants, the kind of valves used, and the size and kind of water jackets and intercoolers.

In the horizontal air compressor, as in the horizontal steam engine, the entire weight of the compressor piston must be sustained by the lower portion of the compressor cylinder. With this type of compressor it is, therefore, necessary to use a lubricant of sufficient body under the heat of

compression to prevent metal contact, and to reduce wear to a minimum. Vertical compressors do not require as much lubricant or as heavy a lubricant as horizontal compressors.

CHARACTERISTICS OF THE LUBRICANT

One of the most important requirements of an air compressor oil is that it should have a viscosity sufficiently high to meet service requirements. For high pressures and temperatures an extra heavy viscosity oil should be used. For medium pressures and temperatures a heavy viscosity oil should be used, and for low pressures and temperatures a medium, and in some cases, a light viscosity oil should be used. The oil should have sufficient body to sustain the weight of the moving parts, to form a seal between the piston rings and the cylinder walls, and to prevent the excessive use of oil. On the other hand, the viscosity should not be too high to obtain efficient atomization or to cause excessive friction. Moreover, if an oil of too great viscosity is used, it will tend to collect any dust that may be in the air and will tend to bake on the hot surfaces and form carbon deposits. This is especially likely to happen when more oil has been used than is just sufficient to lubricate the wearing surfaces.

Another requirement of air compressor oil is that it should not be decomposed under the heat conditions to which it is subjected in the air compressor cylinder, resulting in the formation of carbon. The chief objection to steam cylinder stocks is that they easily decompose under air compressor cylinder conditions, forming sticky and hard carbon deposits in the cylinders and valves or air lines. Carbon deposits are probably the chief cause of air compressor explosions. They also hinder the working of the valves and by increasing the friction cause an increase in the temperature of the air. Carbon also has a tendency to cause bad cutting of the valves and valve seats, which can result in a considerable amount of damage in a short time.

An extremely high flash test has been greatly over-emphasized as a qualification for air compressor oils. Even though the temperature of compression should reach the flash point of the oil an explosion would not take place, as the flash point is considerably increased by the high pressure and as a spark or flame must be introduced before the oil would flash. If carbon deposit is present, which is rendered incandescent by the increased heat of compression, an explosion may occur irrespective of the flash of the oil. The oil would have to be submitted to a temperature much higher than its flash point before combustion would take place without the introduction of a spark or flame. A good example of combustion without the introduction of a flame is that of the Diesel engine in which the temperature is as high as 1,000 deg. F.

One of the troubles commonly met with in compressors is the groaning of the pistons. Generally this can be traced to an improper fitting of the piston rings, which, being subjected to alternating pressure, set up a vibration which allows the air under compression to leak by the piston rings in an unsteady flow. This in turn, increases the vibration of the rings and results in the groaning of the pistons. This condition exists in compressors that have been in use for a considerable time without renewal of rings, and it can frequently be overcome by using a higher viscosity oil.

METHOD OF APPLYING THE OIL

In steam cylinder lubrication it is necessary that the oil be atomized or broken up into small particles so that it will be carried by the steam to the surfaces to be lubricated, as well as to the exhaust valves. The same is true, to a certain extent, in air compressor lubrication, in which case the oil should be atomized by the incoming air, and carried to the surfaces of the cylinder walls and to the exhaust valves. As in the case of steam cylinder lubrication, the atomization

becomes more complete with an increase in distance between the point of introduction of the oil and the valve chest.

Ordinarily the oil is introduced into the air compressor at or above the point of air intake. The greatest efficiency is obtained by the use of automatic lubricators, and many types of compressors are now equipped with these lubricators. In many cases of steam driven compressors two-compartment lubricators are used for feeding two kinds of oil, one to the steam cylinders and the second to the air compressor cylinders. These lubricators insure a uniform rate of feed irrespective of any changes in the air pressure.

AMOUNT OF OIL TO BE USED

It is impossible to make any hard and fast rule as to the proper amount of oil to use in a compressor. Trouble experienced with air compressors is probably more frequently due to the use of an excessive amount of oil than to any other cause. The amount of oil necessary to lubricate an air cylinder is usually about one-third or one-fourth the quantity required to lubricate a steam cylinder of the same size. If the lubricant is unsuitable, an excessive amount is required to keep the cylinders from groaning, and the result of the use of an excessive amount of oil is carbonization, in the air passages, and particularly on the discharge valves. Sticking of these valves, allowing hot compressed air to flow back into the compressor cylinder, is a sign of too much oil. The discharge valves should be examined regularly, and the receiver and discharge pipes blown out. This will effectually remove all oil, water, and sediment, which may have accumulated. The trouble sometimes experienced in the lubrication of the high pressure cylinder of a three stage compressor can usually be attributed to excessive amounts of oil.

Another cause of complaint has been found to be due to the use of unsuitable oils, such as compounded steam cylinder oil, in the air compressor. These oils, besides being very viscid, contain much free carbon matter, which clings to the orifices of the discharge valves and seats gathering dirt from the air. Under the influence of the dry heat together with the dirt from the air, these oils soon become carbonized and form a hard flinty substance that requires considerable labor for its removal, while the animal oil used in compounding separates and forms a sticky residue, which under the dry heat conditions decomposes, liberating a free fatty acid. This will honeycomb or etch the cylinder and piston surfaces and also make the piston rings more brittle.

SIMPLE METHOD FOR TESTING OILS

One of the engineers reports a series of tests which he conducted to determine the effect that heat would have on various lubricating oils when subjected to high temperatures such as exist in an air compressor cylinder. He took a block of cast iron about 6 or 8 in. square and 2 in. thick and placed it on a layer of dry sand in a shallow iron pan, packing the sand close around the cast iron block, and placed the pan over a gas burner. The upper surface of the block was polished and a hole about $\frac{1}{2}$ in. deep drilled in it, large enough to hold the mercury bulb of a thermometer, cylinder oil being poured into the hole so as to make a close heat contact.

Air, taken at a temperature of 60 deg. F. and compressed to 125 lbs. per sq. in. gage pressure, will theoretically attain a temperature of 540 deg. F., but in actual practice, owing to the water flowing through the heads and around the cylinders, the temperature of the discharged air seldom, if ever, goes above 400 deg. in a single cylinder compressor, so the block was heated to this temperature.

When the thermometer showed 400 deg. F. a certain oil was taken that had been used at one compressor plant. This was a very light bodied, paraffine base oil, about like a spindle or ice machine oil. A drop of this oil was allowed to

fall from the point of a lead pencil from a height of 2 in. onto the block. In ten seconds it had spread out to a circle of $1\frac{1}{8}$ in., smoked slightly, and dried up almost instantly, thus indicating that it was a very poor compressor lubricant.

Then a drop of a slightly heavier oil, such as would be suitable for use in turbine and motor bearings, was tried. This spread out quickly to a diameter of $1\frac{1}{2}$ in., smoked slightly and dried up in two minutes. It was but little better than the first oil.

A still more viscid oil, about like a medium bodied engine and machine oil, was then dropped on the hot surface. It spread out slowly to a diameter of $1\frac{3}{4}$ in., smoked slightly, and the surface was oily after five minutes. In the meantime the temperature, as shown by the thermometer, had gone up to 420 deg. F.

A still heavier oil, such as is usually used in gas engines, did still better, even after the temperature had gone up to 450 deg. F. It smoked but little, and a good trace of oil was still on the block after ten minutes.

A steam cylinder oil was then tried. It did not smoke or dry up, but after a while it became thick and gummy.

Even at the highest temperatures the engine oils burned up clean, leaving no trace of dry coke or carbon matter, which tends to confirm the theory that the hard formation often found in and around the discharge valves of air compressors is due largely to the presence of dirt in the air which adheres to the oily surfaces and which, under the continuous dry heat, becomes baked and burnt on.

The deductions that may be drawn from these crude tests are that for such temperatures as would be encountered in a single stage compressor, compressing to 125 lb., a high grade filtered mineral oil of moderately high vaporizing point, suitable viscosity, and especially low in carbon content, will give best and most economical results. If such an oil is used in moderate amounts, if the cooling water is sufficient, if the water jackets of the cylinders and heads do not become choked with mud and sediment, and if the air inlet is properly located, no trouble will be experienced with lubrication.

The location of the air inlet on an air compressor is of great importance, and extra care should be used in placing it at points where dust will not be collected.

AIR COMPRESSOR EXPLOSIONS

While air compressor explosions occur at rare intervals, the fact should be emphasized that properly operated and properly cared for compressors are as harmless as steam engines. The cause of isolated explosions is still a disputed matter, though some phases of the question are now generally agreed upon by engineers familiar with air compressor practice. In the first place, the theory that these explosions are due to the use of an oil with a comparatively low flash point is thoroughly discredited, as they occur more frequently where a high flash oil is used. In the second place, it is generally agreed that the explosion is due to the accumulation of carbon deposits in the air lines. This deposit in turn is caused either by the use of an unsuitable oil, which decomposes, or to the use of an excessive amount of oil, or to the improper location of the air inlet. The belief that the explosion is always produced by the ignition of a volatile mixture, usually of vaporized oil and air, though possibly of coal dust and air, in the air tanks or lines, is questionable in view of the fact that the small amount of oil volatilized in the air compressor cylinder would be insufficient to form an explosive mixture with the air, as this volatile matter is constantly being carried off with the air. It could only be in a case where a very excessive amount of oil was used or where pockets of oily residue were allowed to collect that a sufficient amount of vaporized oil could collect to form with the air an explosive mixture. Even in such a case the cause of the explosion would not be the vaporized oil but would be some other factor which produced a spark or flash. The

probable source of this spark is again the carbon deposit, which may be responsible for a sufficient increase in temperature, by restricting the air passage and thus so increasing the pressure, as to cause the carbon to become an incandescent mass. It is not improbable that in some cases this glowing mass of carbon may weaken the tensile strength of the air receiver or the air lines to such an extent that they are no longer able to withstand the pressure of the air, the result being an explosion.

ROLLERS FOR APPLYING ECCENTRICS

On account of the small amount of clearance around the nuts on eccentrics the work of applying them, even with special wrenches, is usually not easy. To make it possible to get the eccentrics in the most advantageous position when doing the work, rollers on which the wheels are placed are used at the Dale Street shops of the Great Northern. The drawing

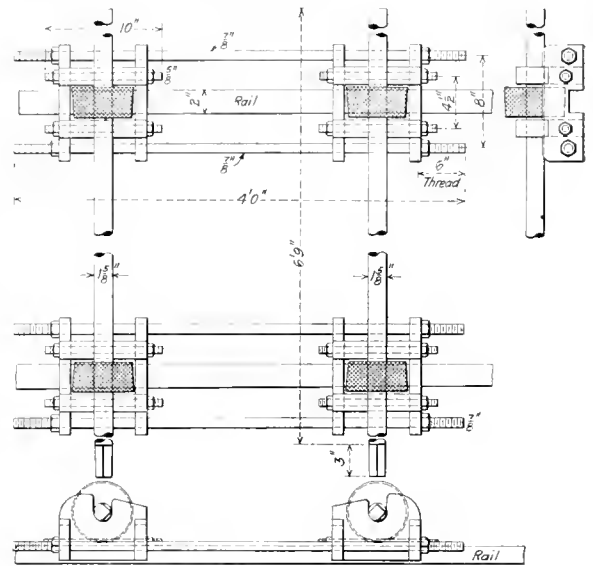

Light Rollers Used in the Wheel Shop

reproduced below will make clear the construction of the device. When in use it is set on the rails and adjusted to hold the wheels clear by a slight amount. The wheels are placed on the rollers and removed by a crane, although if necessary the device could be assembled in position and the wheels raised by screwing up the nuts on the $\frac{7}{8}$ -in. rods connecting the housings. The wheels are turned by a ratchet handle on the shaft of the driving rolls.

RECORD-BREAKING AEROPLANE FLIGHTS.—Lieutenant Resnati, an aviator of the Italian army who has been making experimental flights in this country, arrived at Mineola, L. I., 20 miles east of New York City, in 4 hrs. 11 min. from Hampton, Va., carrying eight men besides himself. The distance is about 320 miles, making the average rate of speed about 76 m. p. h. The machine, a tri-plane, with 85 ft. spread of planes, has three motors of 160 hp. each. Most of the journey was made at a height of about 9,000 ft., at which height the temperature most of the time was about 32 deg. F. On the same day Lieutenant Baldroli, also an Italian, made the same trip in a 210 hp. machine, carrying one passenger, in 2 hrs. 55 min., or at the rate of about 110 miles m. p. h. Passing over New York City, Lieutenant Resnati rose to a height of about 12,000 ft. for the purpose of avoiding disagreeable "air pockets."



LEWIS POWER REVERSE GEAR

The Lewis power reverse gear, which is shown in the illustration, is characterized by simplicity of construction and a high degree of adaptability, so far as its location on the locomotive is concerned. These qualities have been obtained by the location of the control valve in the cab, where it is directly connected to the reverse lever, and by dispensing with the crosshead and guidebar for the piston rod. This gear is the development of the Commonwealth Supply Company, Richmond, Va.

The attachment of the gear to the locomotive is effected

port in the valve housing leading directly to the atmosphere. The valve is operated by means of a stem or port *C*, in the end of which is a slot fitting over a rectangular lug on the top of the valve, thus relieving the valve of any tendency to tilt due to improper alinement of the operating post. To the outer end of the post is keyed a short arm, in the upper end of which is a slot working over a hardened block on the reverse lever.

The reverse lever has no fixed pivot. The initial movement of the lever is pivoted about its lower end, where it is pinned to the back end of the reach rod. The extent of this movement is limited by a special tap bolt in the valve seat, the head of which extends up into the admission port in the valve and permits the valve to move in either direction only sufficiently to register with the admission ports in the valve seat. If the movement of the lever is forward, air is admitted to the rear end of the cylinder and immediately causes a forward movement of the piston. This is communicated to the lower end of the lever through the stroke lever *F* and the reach rod, and permits the continued movement of the upper end of the lever in a forward direction. During this part of the motion the lever is pivoted about the control valve

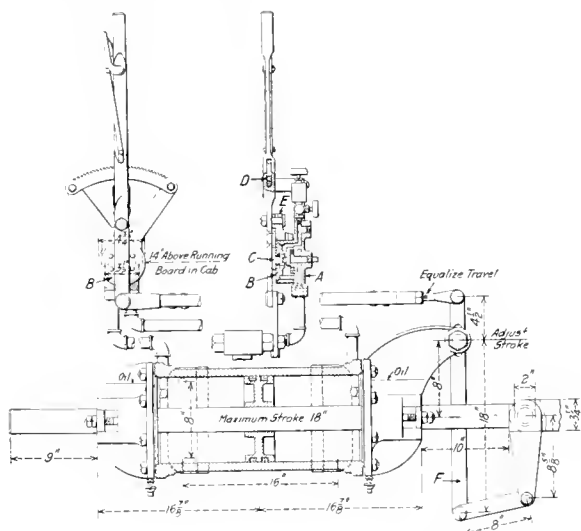

A Simple Power Reverse Gear

by means of brackets cast integral with the cylinder. Because of the absence of attachments for a guidebar or other parts of the gear, it is thus possible to bolt the gear directly to the under side of the running board, to brackets attached to the boiler or to the frame of the locomotive, as the requirements of each particular case may make most desirable. The cylinder is merely turned to bring the faces of the brackets in the desired plane, the cylinder and heads being assembled with the brackets at the top, sides or bottom, as the case may be. The drain cocks have been placed in the cylinder heads in order that there may be no need of drilling special holes in the cylinder for each method of attaching the gear to the locomotive.

The control valve is of the rotary type with the seat in a vertical plane. Air is admitted to the top of the valve at the valve housing *A* and is admitted to the cylinder ports by means of a port through the valve. The exhaust cavity in the face of the valve is always in communication with a

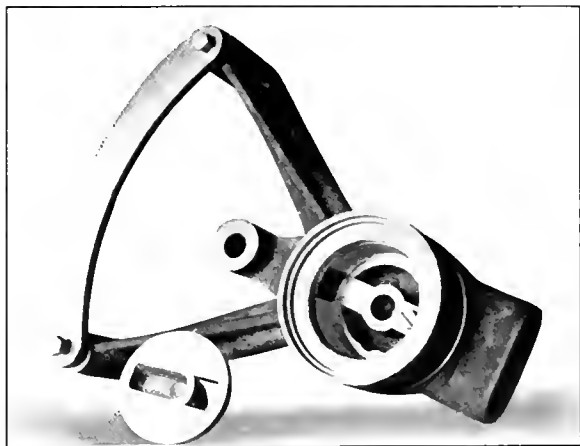

The Quadrant and Valve Housing with the Rotary Valve Removed

connection and is retained in its proper location relative to the quadrant by means of the reverse lever guide *E*. This guide is a sleeve mounted on the valve housing, about which it is free to revolve. When the desired movement of the reverse lever is completed and the lever latched, the latch on the quadrant becomes the fixed point in the further movement of the lever necessary to lap the valve.

The quadrant is notched for 30 cut-off positions each in forward and back motion, a very fine adjustment thus being provided. There is a spring latch *D* on the reverse lever

which operates underneath the quadrant to indicate when the lever is in central position. This assists the hostler in locating the exact center of the motion with certainty.

When there is no air pressure on the reverse gear, the lever can be moved only slightly; it is impossible for it to be thrown into one of the corner positions until air pressure is available to effect the movement of the link block to a corresponding position. This is the result of the limited movement of the rotary valve. After the side of the valve admission port comes in contact with the head of the tap bolt projecting up from the seat of the valve the further movement of the reverse lever is dependent entirely upon the movement of the piston.

One of the unique features of this reverse gear is the ease with which the length of the piston stroke may be adjusted without blocking off the corners of the quadrant. There is a vertical slot in the stroke lever *F* where it is pivoted to the front cylinder head. The end of the pivot pin extends through this slot in which it is secured by two nuts, one on either side of the lever. An adjusting screw, the length of which is equal to that of the slot in the stroke lever, is threaded through the pivot pin, and by means of this screw the position of the pivot pin in the slot is determined. It is possible with this arrangement to vary the relative lengths of the two arms of the stroke lever by an amount sufficient to change the length of the stroke from 18 in., which is its maximum, to 15 in., without affecting the movement of the reverse lever on the quadrant.

A crosshead and guide having been dispensed with, the piston rod is guided by means of long sleeve glands in both cylinder heads. These glands are bored to a running fit for the piston rod and are of sufficient length to provide the necessary bearing area. The glands are adjusted against the packing in the usual manner. The cylinder heads are cast with large oil pockets which communicate with gutters milled in the piston rod glands for lubricating the piston rod packing and gland bearings. The lubrication of the control valve in the cylinder is cared for in the cab, the lubricator being attached directly to the valve housing *A*.

JOURNAL POLISHER

A method for providing a smooth surface on car journals has been developed and patented by W. H. Basenberg of Birmingham, Ala. It consists of a band of leather attached

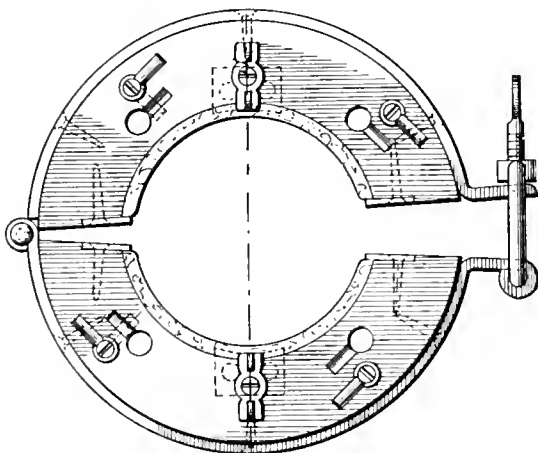

Clamp for the Journal Polisher

to clamps as shown in the illustration, which, when revolved on the journal surface, will give a polished finish. A mixture of emery and oil is used as the polishing mixture. The

apparatus after being applied and clamped to the journal is rotated by an air motor as shown in the illustration. The purpose of this device is to provide a smooth surface on the

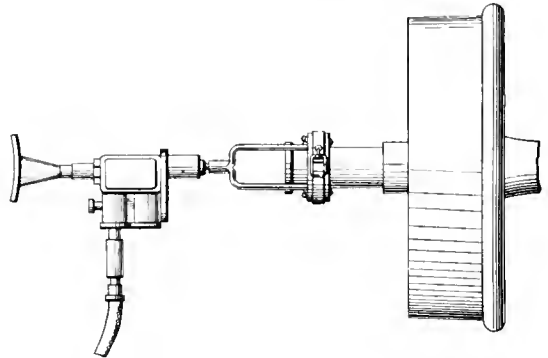

Method of Driving the Journal Polisher

journal which will reduce friction. The size of the journals is accommodated by the various thicknesses of leather used in the clamp.

A DEMONSTRATION OF THE DUCTILITY OF STEEL PIPE

Static tests of material, upon which dependence has long been placed as a means of learning what actually may be expected of the material in service, are of the highest value



Portion of an 18-ft. Length of Steel Pipe Which Crushed to a Length of Six Feet Without Failure

to the engineer. Graphically, however, they fall far short of the conditions often arising in service as a means of demonstrating the physical characteristics of material. The

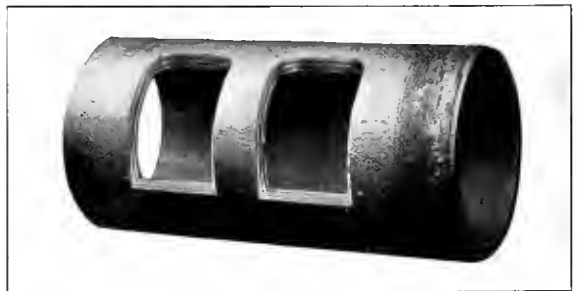

Three Sections of 8 1/4-in. Welded Steel Pipe Telescoped Without Failure

photographs here reproduced do not show the results of laboratory tests and, indeed, the conditions under which the results shown were obtained could hardly be reproduced in the laboratory.

The crumpled piece of pipe shown in one of the illustra-

tions is a part of a section of National Tube Company's steel oil well casing 5 3/16 in. in diameter, the original length of which was 18 ft. This pipe became stuck in the well and an attempt was made to blow it out by the discharge of 170 quarts of nitro-glycerine, it being the purpose at the same time to "shoot" the well. The pipe, however, instead of being blown out of the well, was reduced in length from about 18 ft. to approximately 6 ft. and with considerable difficulty was removed from the well in the condition illustrated. There was no evidence of fracture in any part of this piece of pipe.

The second illustration shows the remarkable result of another oil well accident. In this case a string of casing pipe 8 1/4 in. in diameter, about 1,440 ft. long and weighing over 34,000 lb., was dropped for a distance of 200 ft. to a limestone bottom. The force of the blow caused the three bottom sections to telescope, one inside the other, as shown where a portion of the pipe has been cut away. This was National welded steel pipe and the three lengths telescoped as shown without any evidence of cracks or failure in the welds.

In one of the illustrations the use of these jacks is shown in the set-up of a planer job. The casting to be planed is held down by two clamps only and all other strains are taken by the jack. It will be noted that the vertical jack at the left is set against a fillet in the casting, where it has a grip which becomes more secure the harder the screw is set up. The time required for making this setting and starting the cut is less than 15 minutes. With a suitable selection of sizes of jacks with the two styles of base shown, the use of more or less expensive special fixtures, adapted only to one class of work, may be avoided. Equally good results

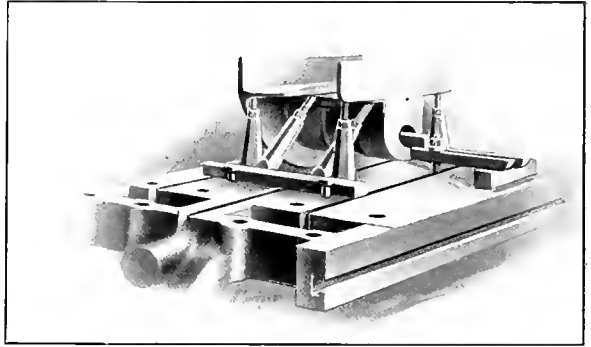

A Planer Set-Up with the Machinists' Jacks

may be obtained by the use of the jacks, which are available for a wide range of work.

The principle of operation of the "C" clamps is exactly the same as that of the machinists' jacks. Its advantage is obvious in that the difficulty usually encountered in clamping sloping or irregular surfaces, because of the tendency of the screw to creep and to cause a shifting of the work, is overcome by the positive, stationary grip of the end of the screw.

There are a number of advantages in the Bradney-Priester lifting jacks not possessed by the usual type of screw jack.

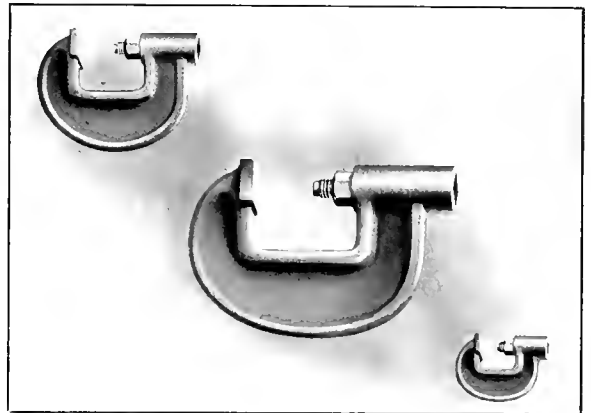

"C" Clamps of the Bradney-Priester Type

It will be noticed that the ram head is solid; it is unnecessary to provide a swivel head which is a source of considerable friction and excessive wear because it is subjected to the action of sand and dirt. In the old style jack screw the operating lever is inserted in a hole directly through the body of the screw and a working space of something over 90 deg. is required in order that the lever may be operated. As the nut is the revolving member in the new jack, it has been possible to provide the circumference of the nut with notches

JACKS WITH NON-REVOLVING SCREWS

In the usual type of screw jack or clamp, the movement of the screw is effected by revolving it in the nut, which is an integral part of the jack body. This necessitates the use of a swivel cap on the end of the screw in order that there may be a stationary bearing against the load. There are several obvious objections to this arrangement which materially limit the range of usefulness of screw jacks.

A type of jack construction has been developed by the

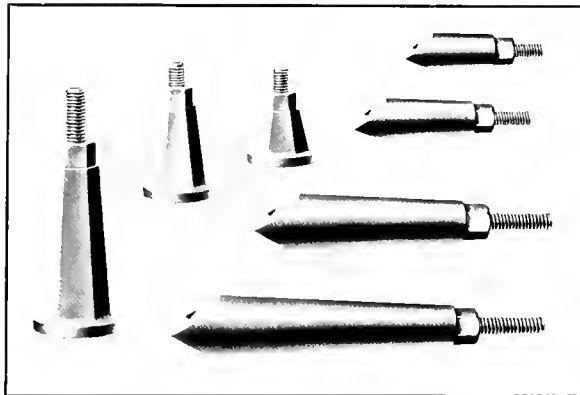

Machinists' Jacks with Non-Revolving Screws

Bradney Machine Co., Inc., Middletown, N. Y., which is designed to overcome these objections to the ordinary type of screw jack. In this construction, which is known as the Bradney-Priester jack screw, the only movement of the screw itself is in line with its own axis. The nut is separate from the body of the jack and revolves on a bearing at the top of the body. Patents have been applied for on this principle of construction.

In the first illustration are shown two types of machinists' jacks for use in "set-ups" on planers, shapers, milling machines, boring mill tables, heavy drill presses, etc., for all classes of work where quick and rigid setting is desirable. As the only revolving part of these jacks is the nut no swivel head is necessary, and the end of the screws are provided with cup, conical or dog points, as the work may require. These points are set up directly against the work, where they maintain a tight grip with no danger of slipping or loosening under heavy strain.

for the use of a special spanner wrench, thus making the operation of the jack possible with a clear space for the wrench of but little more than 18 deg. As the nut revolves, it remains seated on the top of the jack and the load is therefore constantly moving away from the operating lever. With the old style jacks the operator may be given considerable annoyance and is often injured through lack of proper clearance for his fingers. Where this condition exists it remains constant throughout the lift.

Accidents have often happened with the usual type of screw jack because of carelessness of the operator in turning the screw completely out of the base. In the new jacks the screw cannot possibly be raised out of the body while lifting a load. At other times, however, the ram may be removed without delay by taking out a locking pin. The provision of a hole through the handle on the body of the jack, in which the operating lever may be placed, affords a convenient means of insuring against its misplacement or possible loss.

In all forms of this equipment the body of the jack is relieved from wear. The parts subject to deterioration from

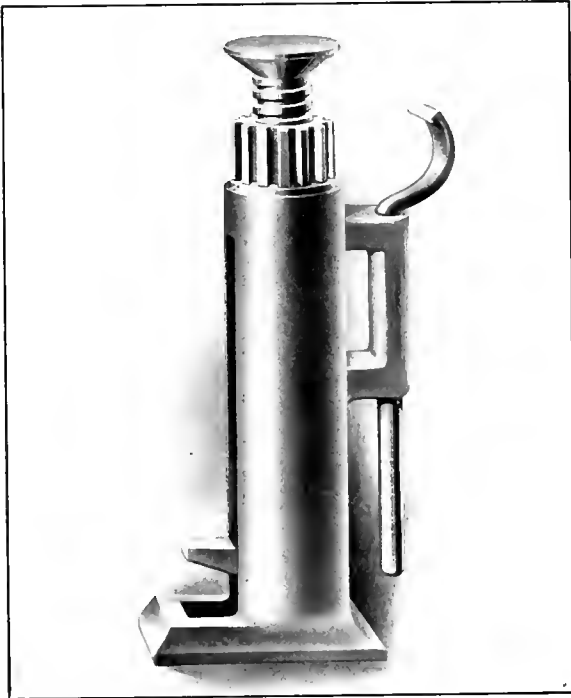

The Bradney-Priester Jack Screw

wear are the nut and the screw, both of which may readily be replaced. As shown in the illustrations, the machinists' jacks are made with bases of two types. Those for vertical use are made in four sizes, ranging from 23¼ in. to 8¾ in., minimum height and 4 in. to 15 in., maximum height. The wedge-base bracing jacks have a range of 33¼ in. to 8¾ in. minimum length in four sizes and a corresponding range of 6 in. to 16 in. in maximum length. There are five sizes of clamps ranging in depth of throat from 1½ in. to 5 in. The clamps have malleable iron bodies, but may be furnished in cast steel if desired, and in form to meet the requirements of special work. The regular sizes of the lifting jacks range in capacity from 10 to 36 tons and special sizes may be provided up to 50 tons. The minimum height of the jacks varies from 8 in. to 24 in. through a wide range of capacity and height combinations.

TESTS OF MOORE HEATER CAR

The Underwriters' Laboratories recently conducted a test of a Moore heater car to determine the fire hazard involved in the use of this heating system. As a result of these trials the use of the car has been approved by the underwriters.

In the tests a complete heater was set up at the laboratory. The size of the car was reduced to obtain conditions less favorable than those found in the ordinary installation. The effect of the movement of the air when the car is in motion was secured by a blower, the velocity of the wind being varied and the action of the heater resulting from varying velocities noted. Records of the temperatures secured were taken from various thermometers placed about the heater and the car.

In the first test, which was conducted with the ventilator door wide open, starting from a temperature of 52 deg. F., the fire was forced until the temperature at the hottest point, directly above the hot air inlet into the car, rose to 428 deg. F. In the second test the vent door was closed and the fire was again forced. Above the hot air inlet the temperature rose to 410 deg. F., and in the heater box above the stove a temperature of 356 deg. F. was reached. Service conditions in a car in transit were duplicated as far as possible in the final test. The blower was operated, causing a wind velocity of 45 miles an hour perpendicular to the side of the car. Under these conditions the temperature above the hot air inlet rose to 440 deg. F. In another trial with the wind from the blower striking the car directly from the end, the highest temperature recorded was 370 deg. F. In none of these tests was any evidence of overheating or charring of the wood noted.

A Moore system heater car has also been examined and approved by the United States Bureau of Explosives. The Moore system is manufactured by the Refrigerator, Heater & Ventilator Car Company, St. Paul, Minn.

McCOY GRAPHITE LUBRICATOR

A device for feeding a mixture of graphite and oil to locomotive cylinders has been placed on the market by the Elijah McCoy Manufacturing Company, Detroit, Mich. The lubricator is attached at the top to the oil pipe from the

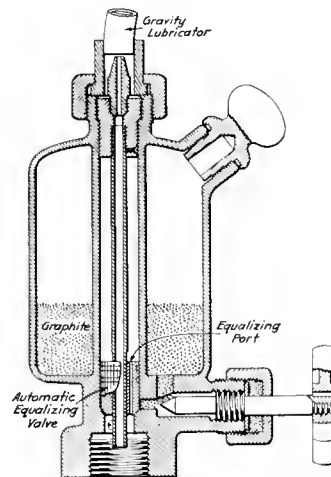

Sectional View of the McCoy Graphite Lubricator

gravity lubricator and at the bottom to the steam chest or steam pipe connection. The outer portion of the lubricator is a reservoir for holding the graphite and oil with a filling plug at the top and a feed valve at the bottom leading to a

passage through the center of the lubricator. In this passage is a stem, which is hollow to allow the passage of steam and oil from the gravity lubricator to the steam chest, the upper portion being fitted with a choke plug. On the lower end of the stem is a valve through which an equalizing port passes. When this valve is closed the feed of graphite is stopped, but when it is open, steam pressure flows into the reservoir and graphite is allowed to flow out. The valve is designed so that any fluctuation in the pressure in the steam chest will cause it to rise and fall on the stem, thus opening and closing the passage to the graphite chamber. Thus the graphite is fed to the cylinders whether the locomotive is running or drifting.

The lubricator requires but little care. It is filled with a mixture of graphite and engine oil by means of a squirt gun when in the roundhouse. The feed valve is then set and no more attention is required until the supply of graphite and oil is exhausted. In case of a failure of the gravity lubricator, it is claimed that a locomotive fitted with the graphite lubricator can proceed to the terminal without danger of failure. One filling of the lubricator is usually sufficient to supply the locomotive for a thousand miles. Several railroads are now using this lubricator and it is claimed that it has resulted in a material reduction in the consumption of valve oil and fuel.

CAST IRON PISTON ROD PACKING

A cast iron piston rod packing which has been used successfully in marine service has been developed for use on locomotives by the Martell Packings Company, Elyria, Ohio. This packing has been designated to meet the particular needs of superheater locomotives. It is made from a selected grade of cast iron and, as shown in the illustrations, consists of a pair of rings of four segments each, which are held in light contact with the rod by a coiled extension spring. This spring is made from a high grade of nickel steel which

made without a change, alteration or adjustment of the packing rings. In this case the diameter of the piston rod was reduced .006 in. during the time the locomotive made the 94,000 miles.

As shown in the drawing the packing is designed to float freely and easily with the lateral motion of the piston rod.

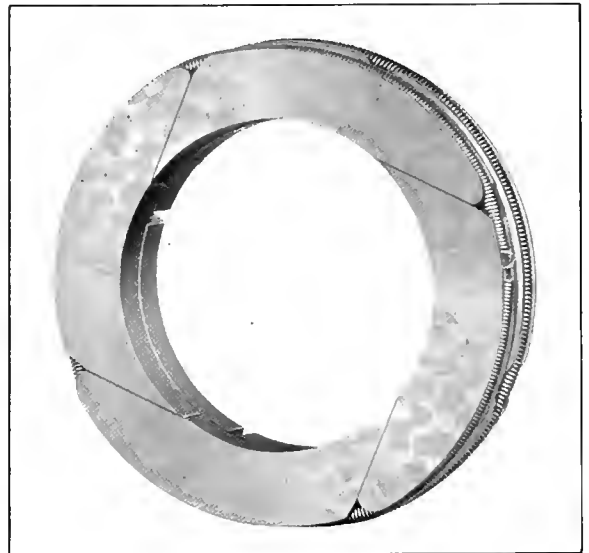

Cast Iron Packing Rings for Piston Rods of Superheater Locomotives

It is designed to prevent any abrasive substance lodging between the packing rings and the piston rod and the wearing parts can be placed without tools of any kind except for a

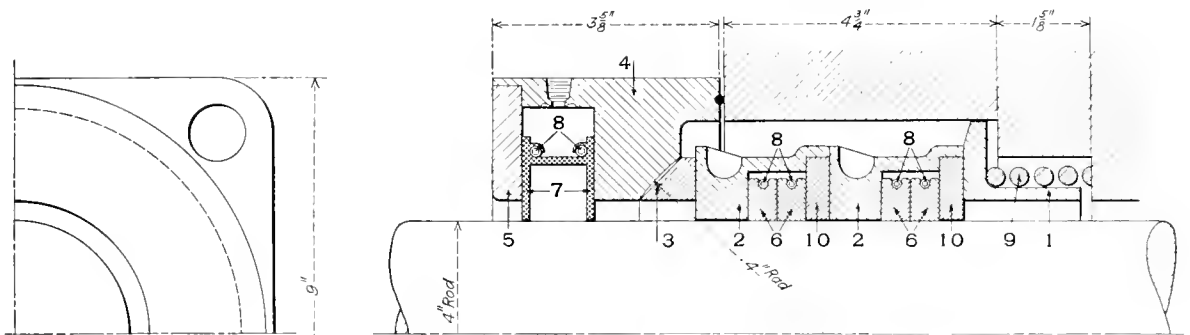

Application of Cast Iron Packing to Piston Rods

- 1—Preventer
- 2—Floating Case
- 3—Ball Ring
- 4—Gland
- 5—Swab Retainer
- 6—Packing Rings
- 7—Swab Case
- 8—Packing Ring Springs
- 9—Spring
- 10—Packing Rings

is not affected by the temperatures obtained on engines using superheated steam.

On marine work where engines run continuously for 12 to 18 days under high degree superheat, this packing has given particularly good results. On the Standard Oil steamer "Polarine" this type of packing was applied in the latter part of 1916 and has been in continuous service ever since with neither the piston rod or the packing rings showing any appreciable wear. In this particular case the boiler pressure carried was 180 lb. and the steam had a total temperature of 650 deg. in the high pressure cylinder. An average mileage of from 50,000 to 60,000 miles per set of rings have been obtained with trial installations on locomotives and in one particular case a mileage of 94,000 miles was

wrench to loosen the gland. It can be applied quickly. The installation shown in the drawing has two sets of two rings each and is designed for a 4-in. piston rod.

ITALY'S COAL SHORTAGE.—Italy needs 800,000 tons of coal to run its railroads, munition factories and war industries. Italy's coal supply is so short that during the past summer more than one thousand square miles of forests were cut for use as firewood and in the preparation of charcoal. More than 500,000 tons of lignite was mined, both wood and lignite being used at present industrially, also on slow trains and switch locomotives. It is impossible to use such material for passenger trains, which have been under great pressure for months, due to military movements.

Railway Mechanical Engineer

(Formerly the RAILWAY AGE GAZETTE, MECHANICAL EDITION
with which the AMERICAN ENGINEER was incorporated)

PUBLISHED ON THE FIRST THURSDAY OF EVERY MONTH BY THE
SIMMONS-BOARDMAN PUBLISHING COMPANY

EDWARD A. SIMMONS, *President* L. B. SHERMAN, *Vice-President*
HENRY LEE, *Vice-President and Treasurer* M. H. WIUM, *Secretary*
WOOLWORTH BUILDING, NEW YORK, N. Y.
F. H. THOMPSON, *Business Manager*, CHICAGO.

Chicago: Transportation Bldg. Cleveland: Citizens' Bldg.
Washington: Home Life Bldg.
London: Queen Anne's Chambers, Westminster.

ROY V. WRIGHT, *Editor*
R. F. THAYER, *Managing Editor*
C. B. PECK, *Associate Editor* A. F. STUEBING, *Associate Editor*

Entered at the Post Office at New York, N. Y., as mail matter of the second class.

Subscriptions, including the eight daily editions of the *Railway Age Gazette* published in June in connection with the annual conventions of the Master Car Builders' and American Railway Master Mechanics' Associations, payable in advance and postage free: United States, Canada and Mexico, \$2.00 a year; Foreign Countries (excepting daily editions), \$3.00 a year; Single Copy, 20 cents.

WE GUARANTEE, that of this issue 9,000 copies were printed; that of these 9,000 copies 7,772 were mailed to regular paid subscribers, 122 were provided for counter and news companies' sales, 323 were mailed to advertisers, 215 were mailed to exchanges and correspondents, and 568 were provided for new subscriptions, samples, copies lost in the mail and office use; that the total copies printed this year to date were 101,347, an average of 9,195 copies a month.

THE RAILWAY MECHANICAL ENGINEER is a member of the Associated Business Papers (A. B. P.) and the Audit Bureau of Circulations (A. B. C.).

The machine and blacksmith shop of the Grand Trunk at Brockville, Ont., were destroyed by fire on November 24.

The members and employees of the Interstate Commerce Commission have subscribed funds to present two ambulances to the Red Cross.

The Denver & Rio Grande has granted an increase in wages of three cents an hour to machinists, boilermakers, blacksmiths and sheet metal workers on its line in Utah.

A general increase in the pay of shopmen on the Pennsylvania Railroad east of Pittsburgh and Erie was announced this week, affecting, it is said, about 10,000 persons. Some clerks are also affected.

According to report, Prof. E. C. Schmidt, head of the department of railway mechanical engineering at the University of Illinois, has received a commission as major in the ordnance department of the Officers' Reserve Corps and hereafter will have headquarters at Washington, D. C.

A compilation of state regulations regarding the housing of railroad employees, prepared by the Bureau of Railway Economics, shows that eight states—Arkansas, Kansas, Mississippi, North Carolina, Oklahoma, Oregon, South Carolina and Texas—have laws requiring railroads to maintain sheds over tracks where car repair work is regularly carried on.

Gold medals bearing the Southern Pacific safety emblem and suitably engraved were awarded recently to the six employees of each division and in each general shop of the Pacific system who, during the year ended June 30, 1917, did the most in furtherance of safety work. C. H. Rippon, piece-work inspector of the Sacramento general shops, carried off the first prize for the second successive time.

The Chicago & North Western and the Chicago, Burlington & Quincy have elected to operate under the provisions of the Wisconsin workmen's compensation act, and have filed certificates. This means that the law will apply to shop men, section hands and all other employees of these roads except those engaged in interstate commerce, whose rights to recovery when injured are governed by the federal employers' liability law. Heretofore only the M., St. P. & S. M. and the Great Northern have been subject to the Wisconsin act.

Henry B. Endicott, manager of the Massachusetts Public Safety Committee, acting as arbitrator in the recent differences between the Boston & Maine Railroad and its shop and other employees, has decided that the employees are not en-

titled to the additional three cents an hour in their pay which they asked for. Their threat to strike for an increase of eight cents an hour was temporarily settled by the road paying an advance of five cents an hour and leaving the difference, three cents, to arbitration; and the result has now been announced. The arbitrator says that he is absolutely clear in the view that the five cents advance has set the men on at least as high a basis as the average in the Eastern half of the country.

Steel Prices Reduced

An agreement between the War Industries Board and representatives of the steel interests fixing maximum prices on a number of steel articles, supplementing the basic prices covered by the agreement of September 24, was announced on October 11 with the approval of the President. The prices, which became effective immediately and are subject to revision on January 1, are as follows:

Commodity	Price agreed upon	Base
Blooms and billets 4 in. by 4 in. and larger.	\$47.50 g.t.	Pittsburgh and Youngstown
Billets under 4 in. by 4 in.	51.00 g.t.	Pittsburgh and Youngstown
Slabs	50.00 g.t.	Pittsburgh and Youngstown
Sheet bars	51.00 g.t.	Pittsburgh and Youngstown
Wire rods	57.00 g.t.	Pittsburgh
Shell bars	3 in. to 5 in.	3.25 per 100 lb., Pittsburgh
	Over 5 in. to 8 in.	3.50 per 100 lb., Pittsburgh
	Over 8 in. to 10 in.	3.75 per 100 lb., Pittsburgh
Skelp	Over 10 in.	4.00 per 100 lb., Pittsburgh
	Grooved	2.90 per 100 lb., Pittsburgh
	Universal	3.15 per 100 lb., Pittsburgh
	Sheared	3.25 per 100 lb., Pittsburgh

First Shipments of Tobacco to Railway Regiments

The Railway Regiments' Tobacco Fund has now become large enough for the commencement of shipments to the railway regiments in France, and the committee in charge of the fund, of which F. A. Poor is chairman, ordered the first shipment to be made on December 1. The shipment on that date consisted of nine cases of tobacco, one for each of the railway regiments now in France. Each case contained twelve 20-lb. packages of tobacco and each package contained 15 pounds of Bull Durham in one-ounce bags with the necessary cigarette papers, and five pounds of Tuxedo smoking tobacco in one-ounce bags. The tobacco will be delivered to the Quartermaster's Department of the United States army in

New York City and the Quartermaster's Department will handle the shipments to Europe.

A large number of contributions were received for the Railway Regiments' Tobacco Fund from railway supply companies during the month of November, subscriptions having been received from the following companies:

Adams & Westlake Company, Chicago.....	\$10 a month
American Arch Company, New York.....(to cover 15 months)	150
American Vulcanized Fibre Company, Boston, Mass.....	10 a month
Anchor Packing Company, Philadelphia, Pa.....	10 a month
Anti-Creeper Corporation, New York.....	10 a month
Belle City Malleable Iron Company, Racine, Wis.....	10 a month
Bettendorf Company, Bettendorf, Iowa.....	10 a month
Burden Sales Company, New York.....(to cover 6 months)	60
Butler Drawbar Attachment Company, Cleveland, Ohio (contribution).....	50
Carnegie Steel Company, Pittsburgh, Pa.....	10 a month
Chambers Valve Company, New York.....	5 a month
Chicago Malleable Castings Company, Chicago.....	10 a month
Chicago Railway Equipment Company, Chicago (contribution).....	100
Chicago Railway Signal & Supply Company, Chicago.....	30
Cleveland Frog & Crossing Company, Cleveland, Ohio.....	10 a month
Crucible Steel Company of America, Chicago.....	10 a month
Curtain Supply Company, Chicago.....	10 a month
Damascus Bronze Company, Pittsburgh, Pa.....	10 a month
Dearborn Chemical Company, Chicago.....	10 a month
Faul Dickinson, Inc., Chicago.....	10 a month
Edison Storage Battery Company, Orange, N. J.....	10 a month
Elliot Frog & Switch Company, East St. Louis, Mo.....	10 a month
Fairbanks, Morse & Co., Chicago.....	10 a month
Fowler Car Company, Chicago.....(to cover 2 months)	50
Fort Pitt Malleable Iron Company, Pittsburgh, Pa.....	10 a month
Fort Pitt Spring & Manufacturing Company, Pittsburgh, Pa.....	10 a month
Franklin Railway Supply Company, New York.....(to cover 6 months)	60
Homestead Valve Manufacturing Company, Pittsburgh, Pa.....	10 a month
H. C. Holloway, Chicago.....	10 a month
Hunt-Spiller Manufacturing Corporation, Boston, Mass.....	10 a month
Illinois Car & Manufacturing Company, Hammond, Ind.....(to cover 6 months)	60
Joliet Railway Supply Company, Chicago.....	10 a month
Kelly Reamer Company, Cleveland, Ohio (contribution).....	10
Kerite Insulated Wire & Cable Company, New York.....	10 a month
Kryolite Railway Equipment Company, Chicago.....	10 a month
Keystone Grinder & Manufacturing Company, Pittsburgh, Pa.....	10 a month
Laas & Spouenberg Company, Chicago.....	10 a month
Laconia Car Company, Laconia, N. H.....	10 a month
Locomotive Superheater Company, New York.....(to cover one year to November, 1918)	120
C. F. Massey Company, Chicago.....	10 a month
J. E. Meek, New York.....(to cover 6 months)	60
Miller Train Control Corporation, Staunton, Va.....	10 a month
Milwaukee Coke & Gas Company, Milwaukee, Wis.....	10 a month
W. H. Miner, Chicago.....	10 a month
Mount Vernon Car Manufacturing Company, Mt. Vernon, Ill.....	10 a month
National Malleable Castings Company, Cleveland, Ohio.....	10 a month
Ottenheimer & Co., Chicago.....	10 a month
Pickands, Brown & Co., Chicago.....(to cover 15 months)	150
Philiad Company, New York.....	10 a month
Pittsburgh Wood Preserving Company.....(to cover 2 months)	20
Ramapo Iron Works, Hillburn, N. Y.....	10 a month
Republic Rubber Company, New York.....	10 a month
Clive Runnells and Le Roy Kramer, of the Pullman Company, Chicago.....	10 a month
F. K. Shulis, New York (contribution).....	25
St. Louis Frog & Switch Company, St. Louis, Mo.....	10 a month
T. W. Spow Construction Company, Chicago.....	30
Steel Car Forge Company, Pittsburgh, Pa.....(to cover 3 months)	10 a month
Strobel Steel Construction Company, Chicago.....	10 a month
T. H. Symington Company, Chicago.....	10 a month
Templeton, Kenly & Co., Chicago.....	10 a month
Joseph K. Turbell, of American Brake Shoe & Foundry Company, New York.....(to cover 6 months)	60
Union Draft Gear Company, Chicago.....(to cover 6 months)	60
Union Spring & Manufacturing Company, Pittsburgh, Pa.....(to cover 6 months)	60
Union Switch & Signal Company, Swissvale, Pa.....	10 a month
H. Vissering & Co., Chicago.....	10 a month
Waterbury Battery Company, Waterbury, Conn.....	10 a month
Watson-Stilman Company, Aldene, N. J.....	10 a month
Western Railway Equipment Company, St. Louis, Mo.....	10 a month
H. H. Westinghouse, New York.....	10 a month
Westinghouse Air Brake Company, Pittsburgh, Pa.....	10 a month
W. H. Woodin, of American Car & Foundry Company, New York.....(to cover 6 months)	60

The subscribers now total 118, the previous subscribers being given in the *Railway Mechanical Engineer* for November, 1917, on page 616.

Fuel Orders for Lehigh Valley and the C. & O.

Orders intended to insure an adequate supply of coal to the Lehigh Valley and the Chesapeake & Ohio have been issued by the United States Fuel Administration. The orders will distribute equitably among the mines adjacent to the roads the burden of furnishing the roads' fuel supply. Both orders took effect on November 19. Mines now under contract to supply the railroads with coal will be required to supply their quota at their contract prices. Other mines will be required to furnish a pro rata supply, and at prices fixed by the government. The railroads will be required to file with the Fuel Administration each week a schedule of the tonnage which must be requisitioned for the next week's supply. The requisition order will be given priority over all contracts for other parties. The Lehigh Valley draws its supply from mines which are not located on its own lines. These mines are ordered to give priority to the demands of the Lehigh Valley, even over requisitions for coal to supply the railroads upon which they are located.

On November 26, similar orders were issued in favor of the New York, New Haven & Hartford and the Central New England. The order directs all mines under contract with these railroads to give preference to the contract requirements over other shipments, except where coal is diverted by direct requisition of the Fuel Administration.

Suit for Violation of Safety Appliance Act Decided in Favor of the Railroad

In a suit for penalties under the Safety Appliance Act it was alleged that the Boston & Maine Railroad hauled over its road, from Gardner, Mass., westward to East Deerfield, a box car which was out of repair by reason of a coupler being missing from the A end of the car. The car, billed from South Mills, Me., to Lake Junction, N. Y., was in a train which left Boston during the night of August 23, 1916; it became defective and was left behind at Gardner, between 1 and 2 o'clock the next morning, with one drawbar pulled out. It was turned around and was attached by its good coupler, behind the caboose, on a freight train going west from Gardner at 7:40 a. m. on August 24. On this train it was taken to East Deerfield, where it was repaired. This was the movement on which the complaint was based. The car contained about 45 pieces of freight, including one cask of gasoline.

Gardner is not a repair point for handling such defects as the car developed. The nearest such point was Fitchburg, 17 miles east from Gardner; East Deerfield is 38 miles west. The freight in the car was destined to points west. The government contended that the car ought to have been taken to Fitchburg, because the distance was shorter. The Federal District Court held that the word "available" in the phrase "to the nearest available point" in the statute cannot be ignored. Availability obviously depends, under the statute, on other conditions besides that of mere distance. Whether Fitchburg was, under all the circumstances, the "nearest available" point for the repair of this car was a matter of business judgment. Upon such a question, involving as it

RAILROAD CLUB MEETINGS

Club	Next Meeting	Title of Paper	Author	Secretary	Address
Canadian	Dec. 11, 1917	Oxy-Acetylene and Electric Welding and Cutting Processes in Locomotive Work.....	A. F. Dyer.....	James Powell.....	P. O. Box 7, St. Lambert, Que.
Central	Jan. 11, 1918	Harry D. Vought.....	95 Liberty St., New York.
Cincinnati	Feb. 12, 1918	H. Boutet.....	101 Carew Bldg., Cincinnati, Ohio.
New England	Dec. 11, 1917	Fuel.....	W. L. Robinson.....	W. E. Cade, Jr.....	683 Atlantic Ave., Boston, Mass.
New York	Dec. 21, 1917	Address: Nationalization of American RT's.....	Arthur M. Thompson.....	Harry D. Vought.....	95 Liberty St., New York.
Pittsburgh	Dec. 28, 1917	I. E. Anderson.....	207 Penn. Station, Pittsburgh, Pa.
St. Louis	Dec. 14, 1917	Patriotic address.....	Hon. Frederick Landis.....	R. W. Frauenthal.....	Union Station, St. Louis, Mo.
South'n & S'w'n	Jan. 11, 1918	A. I. Merrill.....	Grand Building, Atlanta, Ga.
Western	Dec. 17, 1917	The Box Car.....	W. J. Bohan.....	J. W. Taylor.....	1112 Karpen Bldg., Chicago.
		Address.....	A. M. Schover.....		

does many elements, the decision of the men in charge of the business, if made in good faith, is entitled to serious consideration. It was not shown to have been wrong in this instance. On some of the freight speedy delivery may have been important, and it did not appear that there was any car at Gardner into which it could have been transferred. Although the distance of the haul was 20 miles longer than that to Fitchburg, the car "gained on the voyage," and its presence did not appear to have substantially increased the risk of injury to employees. Judgment was entered for the defendant.

Shop Crafts Federate to Press Demands

The various shop crafts on the railroads north, south and west of Chicago, including the Chicago & Eastern Illinois, the Illinois Central, the Chicago & Alton and the Wabash, have federated into one body and have distributed ballots among the members to determine what action shall be taken on the following proposed demands: (1) \$5 for a day of 8 hours for machinists, blacksmiths, boilermakers, sheet metal workers and electricians; (2) \$4.50 per day of 8 hours for car men, including pattern makers, cabinet makers, coach and locomotive carpenters, upholsterers, painters, varnishers, letterers and machine operators in planing mills; (3) \$3.50 per day of 8 hours for the first 6 months and \$4 thereafter for all other car men; (4) \$3.50 per day of 8 hours for helpers in all crafts; (5) for regular apprentices, 20 cents an hour for the first six months and an increase of 2½ cents per hour for each six months thereafter for the first three years, a 5-cent an hour increase for the first 6 months of the fourth year and 7½ cents for the last six months of the fourth year; (6) helper apprentices to start at the minimum wage for helpers for the first six months and to receive an increase of 2½ cents per hour for each six months until the time of apprenticeship has been served; (7) foremen and other men employed by the month to receive a minimum increase of \$20 per month.

No member of a shop craft is to receive an increase of less than 10 cents an hour except apprentices. The ballots are returnable by December 10 and a general meeting of the federation will be held on January 4, 1918.

MEETINGS AND CONVENTIONS

The following list gives names of secretaries, dates of next or regular meetings and places of meeting of mechanical associations:

- AIR BRAKE ASSOCIATION.—F. M. Nellis, Room 3014, 165 Broadway, New York City.
- AMERICAN RAILROAD MASTER TINNERS', COPPERSMITHS' AND PIPEFITTERS' ASSOCIATION.—O. E. Schlink, 485 W. Fifth St., Peru, Ind. Convention postponed.
- AMERICAN RAILWAY MASTER MECHANICS' ASSOCIATION.—J. W. Taylor, Karpen Bldg., Chicago. Convention postponed.
- AMERICAN RAILWAY TOOL FOREMEN'S ASSOCIATION.—R. D. Fletcher, Belt Railway, Chicago. Convention postponed.
- AMERICAN SOCIETY FOR TESTING MATERIALS.—Prof. E. Marburg, University of Pennsylvania, Philadelphia, Pa.
- AMERICAN SOCIETY OF MECHANICAL ENGINEERS.—Calvin W. Rice, 29 W. Thirty-ninth St., New York.
- ASSOCIATION OF RAILWAY ELECTRICAL ENGINEERS.—Joseph A. Andreuccetti, C. & N. W., Room 411, C. & N. W. Station, Chicago.
- CAR FOREMEN'S ASSOCIATION OF CHICAGO.—Aaron Kline, 841 Lawlor Ave., Chicago. Second Monday in month, except June, July and August, Hotel Morrison, Chicago.
- CHIEF INTERCHANGE CAR INSPECTORS' AND CAR FOREMEN'S ASSOCIATION.—W. R. McMunn, New York Central, Albany, N. Y. Convention postponed.
- INTERNATIONAL RAILROAD MASTER BLACKSMITHS' ASSOCIATION.—A. L. Woodworth, C. H. & D. Lima, Ohio. Convention postponed.
- INTERNATIONAL RAILWAY FUEL ASSOCIATION.—J. G. Crawford, 547 W. Jackson Bldg., Chicago.
- INTERNATIONAL RAILWAY GENERAL FOREMEN'S ASSOCIATION.—William Hall, 1126 W. Broadway, Winona, Minn. Convention postponed.
- MASTER BOILERMAKERS' ASSOCIATION.—Harry D. Vourth, 95 Liberty St., New York. Convention postponed.
- MASTER CAR BUILDERS' ASSOCIATION.—J. W. Taylor, Karpen Bldg., Chicago. Convention postponed.
- MASTER CAR AND LOCOMOTIVE PAINTERS' ASSOCIATION OF U. S. AND CANADA.—A. P. Dane, B. & M., Reading, Mass. Convention postponed.
- NIAGARA FRONTIER CAR MEN'S ASSOCIATION.—George A. J. Hochgrebe, 623 Brisbane Bldg., Buffalo, N. Y. Meetings, third Wednesday in month, Staller Hotel, Buffalo, N. Y.
- RAILWAY STOREKEEPERS' ASSOCIATION.—J. P. Murphy, Box C, Collinwood, Ohio. Convention postponed.
- TRAVELING ENGINEERS' ASSOCIATION.—W. O. Thompson, N. Y. C. R. R., Cleveland, Ohio. Next meeting, September 10, 1918, Chicago.

PERSONAL MENTION

GENERAL

CLYDE E. BARNES, mechanical engineer of the Spokane, Portland & Seattle, has enlisted in the navy. He will take the Harvard or Columbia four-months' course in electrical or mechanical instruction for motor boat submarine chasing, after which he will be rated as a machinist's mate in the navy.

W. O. COOK, general road foreman of engines of the Denver & Rio Grande, has been appointed assistant superintendent of the motive power and car departments, with headquarters at Burnham station, Denver, Col. The office of general road foreman has been abolished, but the duties of the position have been assumed by Mr. Cook.

C. H. CRAWFORD, assistant engineer in the mechanical department of the Nashville, Chattanooga & St. Louis, has been loaned to the War Industries Board of the Council of National Defense for service on the storage committee.

SAMUEL J. HUNGERFORD, whose appointment as general manager of the eastern lines of the Canadian Northern, with office at Toronto, Ont., was noted in the November number,



S. J. Hungerford

was born on July 16, 1872, at Bedford, Que., and was educated in the common and high schools. In 1886 he engaged in railroad work as a machinist apprentice of the South Eastern and later served with its successor, the Canadian Pacific, at Farnham, Que. He was then machinist at various places in Ontario and Quebec. On September 3, 1894, he was appointed assistant roundhouse foreman of the Canadian Pacific at Windsor

street, Montreal, and three years later he was transferred to Farnham, Que., as assistant foreman, which position he also held for three years, when he was made locomotive foreman at Megantic, Que. In the following year, 1901, he was advanced to general foreman at McAdam Junction, N. B., and in October of that year was transferred to Cranbrook, B. C., where he acted in the same capacity. In 1903 he was promoted to master mechanic of the Western division with headquarters at Calgary, Alberta. On January 25, 1904, he went to Winnipeg as superintendent of the locomotive shops and on January 1, 1908, was made superintendent of shops. On March 1, 1910, he left the Canadian Pacific to accept the position of superintendent of rolling stock of the Canadian Northern and the Duluth, Winnipeg & Pacific, with office at Winnipeg. On May 1, 1915, his jurisdiction was extended to include all the rolling stock on the 10,000-mile system of the Canadian Northern, his headquarters being moved to Toronto. It is this position which he now leaves to become general manager of the eastern lines.

D. G. CUNNINGHAM has been appointed assistant superintendent of the motive power and car departments of the Denver & Rio Grande, with headquarters at Salt Lake City.

Utah. Mr. Cunningham has also assumed the duties of E. J. Harris, master mechanic, who has resigned.

G. W. DEATS, master mechanic of the Texas & Pacific at Ft. Worth, Tex., has been appointed traveling supervisor of fuel and oil on the Ft. Worth division, with headquarters at Ft. Worth.

WILLIAM H. FETNER, acting superintendent motive power of the Central of Georgia at Savannah, Ga., has been appointed superintendent of motive power; Frederick F. Gaines, superintendent of motive power, who was granted leave of absence in September on account of continued ill health, has been assigned to other duties.

J. L. LAVALLE, master mechanic of the New Orleans, Texas & Mexico at De Quincy, La., has been appointed assistant superintendent, with office at De Quincy.

R. E. LEE, acting manager of the mining and fuel department of the Chicago, Rock Island & Pacific, has been appointed manager of the mining department with jurisdiction over mines and mining operations, with headquarters at Chicago.

W. W. LEMEN has been appointed superintendent of the motive power and car departments of the Denver & Rio Grande, with headquarters at Denver, Col., succeeding W. J. Bennett, resigned.

CHARLES MANLEY, whose appointment as superintendent of machinery of the Missouri & North Arkansas, with headquarters at Harrison, Ark., was announced in the *Railway Mechanical Engineer* for November, was born on September 10, 1867, at Nashville, Tenn. He began railway work on May 1, 1883, with the Texas & Pacific at Big Springs, Tex., and after serving an apprenticeship of four years as machinist with that road, he was employed as machinist by various railroads in the Southwest and West, including the Mexican National, with which he was identified until May, 1910. While with the latter road he was employed successively as general foreman at Laredo, master mechanic at Mexico City, and superintendent of shops at Aguas Calientes. He left Mexico on account of the revolution, but returned in December, 1910, as master mechanic of the Vera Cruz Terminal Company at Vera Cruz, Mex. Subsequently he became superintendent of motive power of the Tehuantepec National. On August 1, 1912, he went to the Missouri & North Arkansas as terminal foreman, one month later he was promoted to master mechanic, and on July 1, 1916, was appointed superintendent at Harrison, Ark., which position he held until his recent appointment as superintendent of machinery.

G. W. MCGOWAN, traveling machinery inspector of the Southern Pacific, has been appointed assistant superintendent of the Texas & New Orleans and of the Galveston division of the Galveston, Harrisburg & San Antonio.

W. L. MCMURRY, an engineer on the Ft. Worth division of the Texas & Pacific, has been appointed supervisor of fuel on the Rio Grande division, with headquarters at Big Spring, Tex.

E. S. PEARCE has been appointed mechanical engineer of the Cleveland, Cincinnati, Chicago & St. Louis, with headquarters at Beech Grove, Ind., succeeding W. E. Ricketson.

CARL SCHOLZ, consulting mining engineer of the Chicago, Burlington & Quincy, at Chicago, has been appointed a member of the Committee of Consulting Engineers on Coal Conservation and Publicity, for the Bureau of Mines, Washington, D. C. A photograph of Mr. Scholz and a sketch of his career were published in the *Railway Mechanical Engineer* for July, 1917, on page 415.

M. TURTON has been promoted to mechanical superintendent of the International Railways of Central America,

with office at Guatemala City, Guatemala, in place of R. Potts, who has resigned to go to another railroad company.

WILLIAM B. WHITSITT, shop engineer of the Baltimore & Ohio, has been appointed assistant chief draftsman in the mechanical department drawing room, at Baltimore, Md.

MASTER MECHANICS AND ROAD FOREMEN OF ENGINES

L. L. ALLEN, general foreman of the St. Louis, Brownsville & Mexico at Kingsville, Tex., has been appointed master mechanic of the Gulf Coast Lines, with headquarters at De Quincy, La.

J. W. COULTER has been appointed master mechanic of the Alton & Southern, with headquarters at East St. Louis, Ill.

T. S. DAVEY, shop superintendent of the Erie at the Buffalo car shops, has been appointed master mechanic in charge of engine terminals at Croxton, N. J.

J. A. DELANEY, master mechanic of the Rio Grande division of the Texas & Pacific, with headquarters at Alexandria, La., has been transferred to Big Spring, Tex.

E. J. HARRIS, master mechanic of the Denver & Rio Grande at Salt Lake City, Utah, has resigned, his duties being assumed by D. G. Cunningham.

W. R. HARRISON has been appointed master mechanic of the Southern Kansas division of the Atchison, Topeka & Santa Fe, with headquarters at Chanute, Kan., succeeding W. H. Hamilton, assigned to other duties.

W. H. KELLER, master mechanic of the Texas & Pacific at Big Spring, Tex., has been transferred to the Ft. Worth division, with headquarters at Ft. Worth, Tex., succeeding G. W. Deats.

C. E. PECK, general foreman for the Southern Pacific at Roseville, Cal., has been promoted to master mechanic of the Portland division, with headquarters at Portland, Ore., succeeding George Wild, resigned.

E. P. SMITH has been appointed road foreman on the Minnesota division of the Northern Pacific, with headquarters at East Grand Forks, Minn., succeeding L. L. Moebeck, transferred.

C. A. WERTH, road foreman of engines of the Northern Pacific at Pasco, Wash., has been appointed master mechanic of the Pasco division, with headquarters at Pasco, succeeding G. F. Egbers, granted leave of absence to enter the Russian railway service corps.

CAR DEPARTMENT

L. C. FITZGERALD, car foreman of the Erie at Buffalo, N. Y., has been appointed shop superintendent at the Buffalo car shops to succeed T. S. Davey.

SHOP AND ENGINEHOUSE

B. G. GAMBLE, roundhouse foreman of the Gulf, Mobile & Northern, has been appointed roundhouse foreman of the St. Louis-San Francisco at Sapulpa, Okla.

L. W. HENDRICKS, master mechanic of the New York division of the New York, New Haven & Hartford, has been appointed superintendent of shops at Van Nest, N. Y., succeeding J. L. Crouse, resigned.

W. H. JAMES, roundhouse foreman of the Chicago & North Western, at Boone, Iowa, has received a commission as lieutenant in the railway regiment recently organized for service in Russia.

PURCHASING AND STOREKEEPING

R. L. AGNER has been appointed division storekeeper of the Southern Railway, with office at Alexandria, Va., succeeding A. B. Lackey, resigned to enter service of United States Army.

H. M. DEWART has been appointed assistant purchasing agent of the Central Vermont, with office at St. Albans, Vt.

W. W. ELDRIDGE has been appointed storekeeper of the Chicago, Burlington & Quincy at Sheridan, Wyo., succeeding M. Josselyn, assigned to other duties.

I. G. MORRISON, store inspector of the Chicago, Burlington & Quincy, has succeeded W. W. Eldridge as storekeeper at Havelock, Neb.

F. D. REED, general purchasing agent of the Chicago, Rock Island & Pacific, with headquarters at Chicago, Ill., will also have charge of the inspection and distribution of the company's fuel. The conservation of fuel used in locomotives, stationary plants and pumping stations will be under the supervision of the mechanical department. The operation and maintenance of coal chutes will be under the jurisdiction of the transportation department and directly in charge of the division superintendent. The above reorganization became effective December 1.

R. E. SCOTT, whose appointment as purchasing agent of the Spokane, Portland & Seattle, with headquarters at Portland, Ore., was announced in the November *Railway Mechanical Engineer*, was born July 17, 1887, at Barnesville, Minn., and graduated from the mechanical engineering department of Purdue University in 1911. The same year he entered the service of Fairbanks, Morse & Co., at Jacksonville, Fla., where he remained until August, 1914, when he became eastern representative of the Gurney Refrigerator Company at New York. On September 1, 1914, he was appointed roadmaster of the Oregon Electric, which position he held until September 30, 1917, when he was appointed purchasing agent of the Spokane, Portland & Seattle, succeeding S. M. Clark, resigned.



R. E. Scott

E. J. SHIELDS has been appointed general storekeeper of the Kansas City, Mexico & Orient, with headquarters at West Wichita, Kan., succeeding C. A. Keller, resigned to accept service with the United States government.

C. T. WINKLESS, superintendent of fuel of the Chicago, Rock Island & Pacific, at Chicago, has been transferred to the purchasing department, reporting to F. D. Reed.

NEW SHOPS

OREGON-WASHINGTON RAILROAD & NAVIGATION COMPANY.—This road is building a roundhouse at Tacoma, Wash., which will cost about \$10,000. The building will contain three stalls, 97 ft. long. It will be a frame structure with concrete pits and concrete footings supported on piles. The contract for the work was let to the E. J. Rounds Construction Company, Seattle, Wash.

GULF, COLORADO & SANTA FE.—This company is contemplating the construction of a freight station and a machine shop at Temple, Tex. The proposed machine shop will be 60 ft. by 100 ft., with concrete foundations, brick walls, machinery foundations, electric light, steam heat and tar and gravel roof. The structure will cost \$15,000, exclusive of machinery.

SUPPLY TRADE NOTES

The Combustion Engineering Corporation, Chicago, announces that six men in its drafting room have joined the colors.

Howard D. Taylor, of the Remington Arms Company, Eddystone, Pa., has been elected vice-president of McCord & Co., Chicago.

J. M. Betton, maker of injector sand blast apparatus, formerly at 26 Park Place, has removed his office to 59 Pearl street, New York.

H. P. Edison of the Washington Steel & Ordnance Company, Washington, D. C., will represent the Vanadium Alloys Steel Company in the Pittsburgh district.

M. J. Madison has resigned as Chicago district manager of the Vanadium Alloys Steel Company to accept a position with the Weir Frog Company of Cincinnati, Ohio.

Allen R. Miller, of the B. F. Goodrich Company, railroad sales department, at Akron, Ohio, has been transferred to the B. F. Goodrich Rubber Company, 1780 Broadway, New York, as eastern representative.

Henry Gaul, who for many years was connected with the Ajax Manufacturing Company of Cleveland, Ohio, died recently. He had a wide acquaintance among railroad men and was known as an expert on forging machine matters.

Joseph Sinkler has resigned as western representative of the Economy Devices Corporation to become special representative in Chicago and tributary territory for the Perolin Railway Service Company.

Mr. Sinkler was born at Scranton, Pa., on December 14, 1874, and began his mechanical career with the Dickson Locomotive Works in the same city. He remained with that company three years and later was employed on the New York, Susquehanna & Western two years and for the succeeding two years on the Delaware, Lackawanna & Western. He became associated with the Franklin Railway Supply Company on July 1, 1904, and continued with that company until January 1, 1916, when he was appointed western representative of the Economy Devices Corporation at Chicago. He assumed his duties as special representative of the Perolin Railway Service Company on November 15.



J. Sinkler

W. R. Toppan, who for 15 years was identified with the Kennicott Company, which recently discontinued business, is now manager of the railroad department of the William Graver Tank Works, Chicago, the new proprietor of the Kennicott type "K" water softener.

Don L. Clement, eastern railway representative of Pratt & Lambert, Buffalo, N. Y., with offices in New York, has received a commission as first lieutenant of the 35th Regiment Railway Engineers, now stationed at Rockford, Ill.

The National Railway Appliance Company, New York, has been made the eastern and southern representative of the Valley Steel Company of East St. Louis, Ill., and will handle its full line of axles, locomotive driving axles, piston rods, side rods and crank shafts, in normal or heat treated grades.

Peter H. Murphy, president of the Standard Railway Equipment Company, New Kensington, Pa., died at Pittsburgh, Pa., on November 7. Mr. Murphy was born at Bennington, Vt., on March 16, 1846. He served as machinist apprentice and locomotive engineer on the Erie and was also an engineer on the Pennsylvania Railroad and on the Union Pacific, running the first night express west out of Omaha. He was later division master mechanic of the Baltimore & Ohio at Cumberland, Md., master mechanic of the Toledo, St. Louis & Western and general master mechanic of the Cairo Short Line. He left railroad work in 1888 to engage in the manufacture of car roofs.

W. J. Schlacks, general manager of McCord & Co., Chicago, was recently elected director and vice-president of that company, with headquarters at Chicago. Mr. Schlacks was



W. J. Schlacks

born in Chicago on March 28, 1874. His first railroad experience was as a machinist apprentice on the Illinois Central. Later he went with the Denver & Rio Grande, after which he entered Leland Stanford, Jr., University. Following his graduation from college he was appointed assistant mechanical engineer on the Denver & Rio Grande. He was later appointed mechanical engineer on the Colorado & Midland, following which he was general foreman

and superintendent of machinery on the same road. In September, 1906, Mr. Schlacks was appointed western sales agent of McCord & Co. and in October, 1914, was promoted to general manager with headquarters in Chicago. As vice-president he will continue to have headquarters at Chicago.

L. F. Hamilton, manager of the advertising and specialty department of the National Tube Company, Pittsburgh, Pa., on December 1 became associated with the Walworth Manufacturing Company, Boston, Mass., and was succeeded by W. L. Schaeffer, his assistant. The Walworth Manufacturing Company recently purchased the Kewance works and the Kewance line of products from the National Tube Company. Mr. Hamilton will take up approximately the same duties with the company that he had with the National Tube Company, more particularly the training of specialty students, the supervision of specialty and sales promotion work, etc.

Charles H. Stoer and M. A. Sherritt, of the Sherritt & Stoer Company, Inc., machinery dealers of Philadelphia, who recently acquired the stock of the Betts Machine Company of Wilmington, Del., have disposed of the real estate, buildings and equipment to E. I. du Pont de Nemours & Co. The business of the Betts Machine Company will be continued with improved facilities since the new owners retain the good will, patents, patterns, drawings, jigs, fixtures, etc. The new officers are: M. A. Sherritt, president; Geo. W. Moreton, vice-president, and C. H. Stoer, secretary-treasurer, and the general offices have been moved to the Finance building, Philadelphia.

Economy Devices Corporation and Franklin Railway Supply Company Merged

With a view to concentrating into one organization two groups of men who have been working along parallel lines in the development of increased efficiency of the steam locomotive, the Economy Devices Corporation and the Franklin Railway Supply Company have been merged into a new corporation, namely, the Franklin Railway Supply Company, Inc.



J. S. Coffin

The officers of the new company will be as follows: J. S. Coffin, chairman of the board of directors; S. G. Allen, vice-chairman; H. F. Ball, president; Walter H. Coyle, senior vice-president; J. L. Randolph, vice-president in charge of western territory; C. W. Floyd Coffin, vice-president in charge of eastern and southern territory; C. L. Winey, secretary and treasurer; Harry M. Evans, eastern sales

manager; C. J. Burkholder, western sales manager; Hal R. Stafford, chief engineer, and William T. Lane, mechanical engineer.

Joel S. Coffin, chairman of the board of directors, brings to the new company a wide and varied knowledge gained from 14 years of railroad work and 26 years in the railroad supply field. He began as machinist apprentice and became fireman, engineer and road foreman of engines. Most of his experience was on the Wisconsin Central. He left the railroad to enter the mechanical department of the



S. G. Allen

Galena Signal Oil Company as mechanical expert, was promoted to manager of that department and several years later was elected vice-president. After serving as vice-president for two years, he resigned to accept the vice-presidency of the American Brake Shoe & Foundry Company, which position he held until 1911. In 1902 he organized the Franklin Railway Supply Company, of which he was president up to 1916, when

he was elected chairman of the board. In addition to being chairman of the board of directors of the Franklin Railway Supply Company, Inc., Mr. Coffin is a director in a large number of other corporations.

Samuel G. Allen, vice-chairman of the Franklin Railway Supply Company, Inc., is both a lawyer and a business man. He was plunged into business responsibilities immediately after leaving college and studied law in his spare time. He was admitted to the bar in Warren County, Pa., and practiced for nine years in the oil districts of Pennsylvania. When the Franklin Railway Supply Company was formed

in 1902. Mr. Allen was elected secretary and treasurer, and later became vice-president, and in 1916 was elected president.

H. F. Ball, president of the Franklin Railway Supply Company, Inc., has spent his entire business life in intimate contact with locomotive operation and construction. After serving his time in the locomotive and car departments of the Pennsylvania Railroad at Altoona, he entered the drafting room, and two years later entered the service of the Lake Shore & Michigan Southern as chief draftsman. He held successively the positions of general foreman car shops, general car inspector, mechanical engineer and superintendent of motive power.



H. F. Ball

He resigned from the Lake Shore to become vice-president in charge of engineering of the American Locomotive Company, which position he occupied until 1913, when he left the company to become president of the Economy Devices Corporation.

Walter H. Coyle, senior vice-president of the Franklin Railway Supply Company, Inc., brings to his new position experience gained by many years in both railroad work and the railroad supply field. Mr. Coyle was for 11 years in the service of the Erie Railroad in the mechanical and traffic departments.



W. H. Coyle

Upon leaving the railroad he became identified with the Kent Manufacturing Company, and later entered the mechanical department of the Franklin Railway Supply Company. He spent six years in this department, when he was called to New York as assistant to the vice-president and placed in charge of the sales department of the central territory. He was elected second vice-president shortly after, and then vice-president, which position he held up to the time of his election as senior vice-president of the new organization.



J. L. Randolph

Supply Company, Inc., takes charge of the western territory, with office in Chicago. Mr. Randolph began as a machinist apprentice in the Concord, N. H., shops of the Northern Railroad, now a part of the Boston & Maine. Subsequently he served this road in the capacity of machinist, gang foreman, general foreman, master mechanic and superintendent of shops. He left the railroad to accept a position in the mechanical department of the Franklin Railway Supply Company. Three years later he was appointed sales manager of the Economy Devices Corporation, and in 1906 was elected vice-president.

C. W. Floyd Coffin, vice-president of the Franklin Railway Supply Company, Inc., takes charge of the eastern-southern territory, with office in New York. Mr. Coffin's entire business experience has been in the railroad supply field. After leaving Cornell University he spent five years in the treasury, sales and service departments of the Franklin Railway Supply Company. He was then transferred to Chicago as assistant western sales manager, and later promoted to western sales manager, which position he held up to the time of his appointment as vice-president of the Franklin Railway Supply Company, Inc.



C. W. F. Coffin

C. L. Winey, secretary and treasurer of the Franklin Railway Supply Company, Inc., is a man of extended experience, both in railroad work and in the railroad supply field. Starting his career on the Pennsylvania Railroad, he spent three years in the motive power department, one year in the maintenance of way and signal department, and two years in the transportation department. He left railroad work to enter the service of the Galena Signal Oil Company, and five years later accepted the position of secretary and works manager of the Kent Manufacturing Company. In 1908 he was elected secretary and treasurer of the Franklin Railway Supply Company, which position he held until he was elected secretary and treasurer of the Franklin Railway Supply Company, Inc.



C. L. Winey

Harry M. Evans has been appointed eastern sales manager of the Franklin Railway Supply Company, Inc., with office in New York. Mr. Evans began railroad work as a call boy on the Erie, and served in various positions in the mechanical, transportation and traffic departments of that road. Upon leaving the Erie he entered the mechanical department of the Franklin Railway Supply Company as traveling representative. He was promoted to assistant western sales manager, and shortly after was made eastern sales manager, which position he held at

the time of his recent appointment as eastern sales manager of the Franklin Railway Supply Company, Inc.

C. J. Burkholder has been appointed western sales manager of the Franklin Railway Supply Company, Inc., with office in Chicago. Up to 1916 Mr. Burkholder's business experience had been entirely in railroad work. He was employed in the roundhouse of the Pennsylvania Railroad at Tyrone, Pa.; and later was a locomotive fireman. Leaving the Pennsylvania Railroad, he became a locomotive engineer on the Union Pacific, and later on the Kansas City Southern. He was in turn promoted to traveling engineer, trainmaster, general road foreman of engines and division superintendent. In 1916 he accepted a position with the Economy Devices Corporation as mechanical representative in the western territory, which he held up to his present appointment.

Hal R. Stafford, chief engineer of the Franklin Railway Supply Company, Inc., has for the past 17 years been active in locomotive development. On leaving college he started as a special machinist with the Schenectady Locomotive Works, and shortly afterward was transferred to the drawing room. A year later he took charge of the cylinder and valve division. Eight years later he was made assistant to the consulting engineer in charge of compound locomotives. While in this position he helped develop the first Mallet locomotive, the Cole balanced compound and the Cole-Stafford balanced simple locomotive. For some years he represented the American Locomotive Company, conducting road tests joint with various railroads. When the Economy Devices Corporation was formed he was appointed mechanical engineer of that company.

William T. Lane, mechanical engineer of the Franklin Railway Supply Company, Inc., has spent his entire business career in the railway supply field. For the past six years he has been constantly in touch with locomotive development. On leaving college he went as an apprentice with the Franklin Portable Crane & Hoist Company. His next position was as draftsman for the Franklin Railway Supply Company, then chief draftsman. In 1915 he was made mechanical engineer.

Charles A. Carscadin, president of the National Car Equipment Company, Chicago, has been elected vice-president of the Joliet Railway Supply Company, Chicago. James H. Slawson, vice-president of the Joliet Railway Supply Company, has been elected a vice-president of the National Car Equipment Company.

E. A. Hawks, of Detroit, has been appointed special representative for the Youngstown Steel Car Company, Youngstown, Ohio. Mr. Hawks will handle the selling of the products of this concern to certain railway companies, and also among the automobile companies. His office is in the Dime Bank building, Detroit, Mich.

L. R. Dressler, traveling inspector of the American Arch Company, New York, has received a commission as first lieutenant in the Ordnance Officers Reserve Corps. Mr. Dressler had been in the employ of the American Arch Company since May, 1916, previous to which he was a special apprentice of the New York Central at West Albany.

R. L. Browne, who for the past 15 years has been identified with the electrical and mechanical engineering profession, has recently become associated with the sales department of the Goldschmidt Thermit Company, New York, in the capacity of commercial engineer, after having spent several months in the foundry of that company acquiring a practical knowledge of the Thermit process of welding.

The Glazier Manufacturing Company, Rochester, N. Y., one of the oldest manufacturers of headlights, cases and reflectors, has reorganized, and has elected Frank Ocumpaugh president and general manager, and Fred Kimmel vice-president. Mr. Kimmel is also president of the Rochester Motors

Company. Mr. Ocumpaugh was born in Rochester, New York, and after finishing a common and high school education entered business in 1890 as purchasing agent of the Vacuum Oil Company, Rochester, N. Y. He held that position for 27 consecutive years, during which time the size and business of the Vacuum Oil Company expanded tremendously. Two years ago he went into the real estate business, which he has now given up to devote his time to the manufacture of Glazier products. Oscar F. Ostby, who is manager of sales for the company, maintains headquarters at the Grand Central Terminal, New York. A sketch of Mr. Ostby's life appeared in the November number of the *Railway Mechanical Engineer*.

Lewis A. Larsen, assistant comptroller of the American Locomotive Company, has resigned to accept the position of assistant to the president of the Lima Locomotive Works, Inc., with headquarters at Lima, Ohio. Mr. Larsen was born at Ridgeway, Ia., in 1875. He received his early education in the public schools of Ridgeway and Decorah, Ia., and Upper Iowa University, Northwestern University and St. Paul College of Law. In November, 1897, he entered the service of the Chicago Great Western as clerk to the master mechanic. He held successively the positions of chief clerk to the superintendent of motive power and chief



L. A. Larsen

clerk to the assistant general manager. In 1904 he resigned to accept the position of chief clerk to the superintendent of motive power of the Northern Pacific at St. Paul. In November, 1906, he became associated with W. H. S. Wright, railway supplies, representing the Railway Steel Spring Company, the Pittsburgh Forge & Iron Company and other companies, and in 1907 entered the service of the American Locomotive Company. In 1909 he was appointed assistant to the vice-president in charge of manufacturing and in July, 1917, was appointed assistant comptroller. For several years past Mr. Larsen has been a special lecturer in the Alexander Hamilton Institute, New York. He has also contributed a number of papers to the railroad magazines.

A Locomotive an Hour

Production records at the Baldwin Locomotive Works are being broken weekly. It is reported that in a recent week about 100 locomotives of various sizes were turned out, and President Alba B. Johnson is authority for the statement that the plant is completing a locomotive an hour.

President Johnson at the directors meeting also said:

"During 1916, 1,960 locomotives were made, an average of 160 a month. Large contracts for machining shells were executed and a considerable portion of the force, which ranged from 12,000 to 18,500 men, was diverted to shell manufacturing. All of these contracts except one, for the French Government, were run out during the spring of 1916. The French contract was completed in November. In 1917 the working force was increased approximately to 20,000 men. Locomotive production was largely increased and for ten months ending October 31, 1917, 2,254 were shipped, at the rate of 225 a month. This increase will be continued during November, December and the months of 1918.

CATALOGUES

ADJUSTABLE HUB PLATES.—A book has been published by the Smith Locomotive Adjustable Hub Plate Company, Chicago, which describes the application and maintenance of the adjustable hub plate, the use of which is licensed by this company.

BRASS FOUNDRY EQUIPMENT.—The Whiting Foundry Equipment Company, Harvey, Ill., has issued catalogue No. 128 describing its furnaces, tongs and tumblers for use in brass foundries. The catalogue contains eight pages, is well illustrated and gives information regarding the various products.

MILLING CUTTERS.—The Cleveland Milling Machine Company, Cleveland, Ohio, is issuing a stock list of milling cutters on the fifteenth of each month. In this stock list each type of milling cutter is illustrated and the number of each size and quality of material which are available for immediate shipment are tabulated. Copies will be furnished on request.

AMERICA'S AIRPLANES.—An interesting booklet bearing this title has been published by the Gisholt Machine Company, Madison, Wis. It contains numerous illustrations showing the development of airplanes and dirigibles from the earliest types to those which are now being built for use in the war zone. There is also a section devoted to airplane engines and the manufacture of engine parts.

INSULATING BRICK.—The Armstrong Cork & Insulation Company, Pittsburgh, Pa., has issued a folder describing tests made to determine the economy in fuel obtained by the use of Nonpareil insulating brick for boiler settings. One illustration is included showing the method of applying the insulating brick in the boiler setting. The tests showed that 63 per cent of the heat lost was saved by the use of this brick.

GRINDING WHEEL REFERENCE CARD.—The American Emery Wheel Works, Providence, R. I., has published a grinding wheel speed and reference card. One side of the card shows the kind of abrasive, grain and grade recommended for various classes of work, while the other side shows the revolutions per minute for speeds of 4,000, 5,000 and 6,000 ft. per minute for wheels ranging from 1 to 60 in. in diameter.

HOISTING MACHINERY FOR INDUSTRIAL WORKS.—Under this title the Shepard Electric Crane & Hoist Company, Montour Falls, N. Y., has issued a loose-leaf catalogue bound in a heavy manila cover. The catalogue refers in detail to the construction and specifications of the Shepard monorail hoists, gives a complete outline of the terms and conditions of purchase, including prices and discounts. It contains all the information necessary for selecting and specifying the various types and sizes of hoists. Clearance drawings for each type are given.

THE DESIGN OF FORGING MACHINE DIES.—A paper on the "Laws Governing Forging Machine Die Design," by E. R. Frost, general manager of the National Machinery Company, which was read before the American Drop Forge Association, has been reprinted by the National Machinery Company, Tiffin, Ohio, as Forging Machine Talk No. 27. The principles governing the design of dies for forging machines have been reduced to simple rules, and numerous illustrations show the application of these rules in making various classes of forgings. The paper contains information that will be of value in shops where forging machines are used.

OXY-PINTSCH METAL CUTTING.—An attractive eight-page booklet has been issued by the Pintsch Compressing Com-

pany, 2 Rector street, New York, describing the model "C" Oxy-Pintsch cutting equipment furnished by this company. This booklet sets forth the advantages of Pintsch gas for metal cutting and contains a brief description with illustrations of the various parts of its complete outfit. This includes an oxygen pressure regulator, high and low pressure Pintsch gas regulators, the use of which depends upon whether the gas is drawn from flasks or from low pressure service pipe lines, and the cutting torch.

UNIVERSAL VERTICAL AND HORIZONTAL BORER.—The Oliver Machinery Company, Grand Rapids, Mich., has issued a four-page folder containing illustrations and specifications of its No. 74 Universal vertical and horizontal wood boring machine. This machine has a single spindle each in the horizontal and vertical positions, which have a capacity of boring holes up to three inches in diameter. The folder also contains illustrations of the Oliver "Little Pattern Makers," which are boring machine cutting tools for use in profiling and core box work, fillet cutting, etc., operations which the pattern maker is often compelled to do by hand.

"HYDRO" PRESSURE AND DRAFT RECORDERS.—Catalogue "D" of the Bacharach Industrial Instrument Company, Pittsburgh, Pa., is an eight-page pamphlet in which is described in detail the design and construction of the "Hydro" recording instruments. The moving element of these recorders is a bell floating in water, to which is attached a recording pen. The position of the pen is determined by the differential pressure between the inside and outside of the bell. The instruments are made in several types, both recording and indicating, for a variety of uses where draft vacuum, low pressures and differential gas pressures are to be measured.

CUTTING AND THREADING TOOLS FOR PIPE.—This is the title of catalogue No. 12 of the Borden Company, Warren, Ohio, a neatly gotten up 32-page booklet covering the "Beaver" line of pipe tools. The line includes a number of types and sizes of die stocks and square-end pipe cutters. In the "Beaver" die stocks, the dies themselves are without taper, the taper thread being cut by automatically moving the dies away from the pipe as the threading operation progresses. Since the dies are straight but few teeth are required, and the range of adaptability is materially increased. The catalogue explains the principle on which these dies operate and contains a complete illustrated list of repair parts.

IRON AND STEEL FOR EXPORT.—The English edition of the new 94-page iron and steel catalogue of the American Steel Export Company is now ready for foreign distribution. The Spanish, French, Portuguese, Italian and Russian editions are to be published shortly, now being in process of preparation. This catalogue contains much information, such as weights and measures in English and metric tables, and data covering such products as pig iron, billets, blooms, slabs and sheet cars, plates and shapes, tool steel, merchant bars and agricultural steel, wire products, pipe and tubing, rails and railway supplies, castings and forgings, sheet and tin plate, etc. The object of the catalogue is to inform overseas buyers concerning American sizes, weights, etc. The booklet also includes specifications covering tolerances and other valuable data.

PENNSYLVANIA HOLDS FAST TRAIN FOR SICK WATCHMAN.—The Pennsylvania Railroad company showed the human side of the corporation one morning recently when it held up one of its through passenger trains running as an extra with first class privileges for half an hour to get a doctor on board who would carry relief to a lone watchman in a little box six miles west of Lewistown Junction, Pa., suffering from an acute attack of cramps. After the doctor had administered first aid to the sick watchman, both were brought to a local hospital in the caboose of a freight train.

CARNEGIE LIBRARY OF PITTSBURGH



3 1812 04296 1202

